

FEATURES

- Low turn-on voltage
- Fast switching
- Also available in lead free version

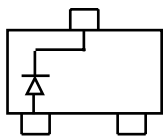

BAS70 Marking: 73

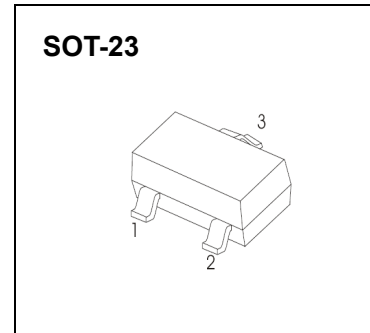
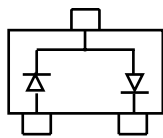

BAS70-04 Marking: 74

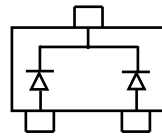

BAS70-05 Marking: 75

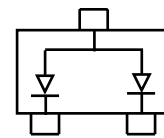

BAS70-06 Marking: 76

MAXIMUM RATINGS @Ta=25°C

Symbol	Parameter	Value	Unit
V_R	DC Voltage	70	V
I_F	Forward Continuous Current	70	mA
P_D	Power Dissipation	200	mW
$R_{\theta JA}$	Thermal Resistance from Junction to Ambient	500	°C/W
T_J	Junction Temperature	125	°C
T_{stg}	Storage Temperature	-55~+150	°C

ELECTRICAL CHARACTERISTICS (Ta=25°C unless otherwise specified)

Parameter	Symbol	Test conditions	Min	Max	Unit
Reverse breakdown voltage	$V_{(BR)}$	$I_R = 10\mu A$	70		V
Reverse voltage leakage current	I_R	$V_R = 50V$		120	nA
Forward voltage	V_F	$I_F = 1mA$ $I_F = 15mA$		410 1000	mV
Diode capacitance	C_D	$V_R = 0V$ $f = 1MHz$		2	pF
Reverse recovery time	t_{rr}	$I_F = I_R = 10mA, I_{rr} = 0.1 \times I_R,$ $R_L = 100\Omega$		5	ns

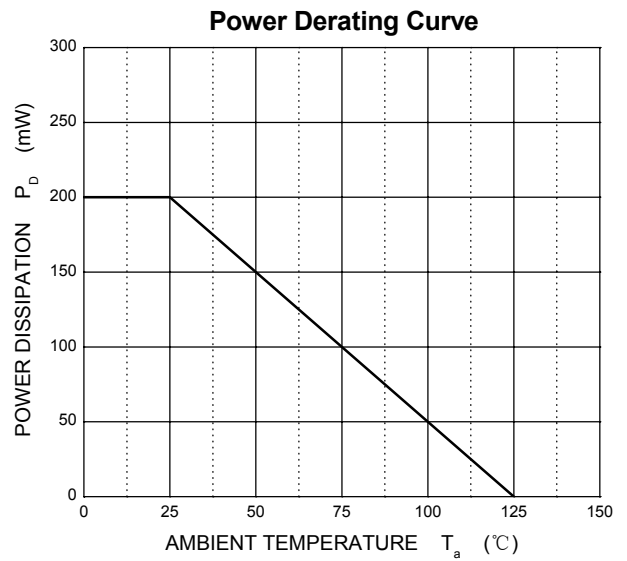
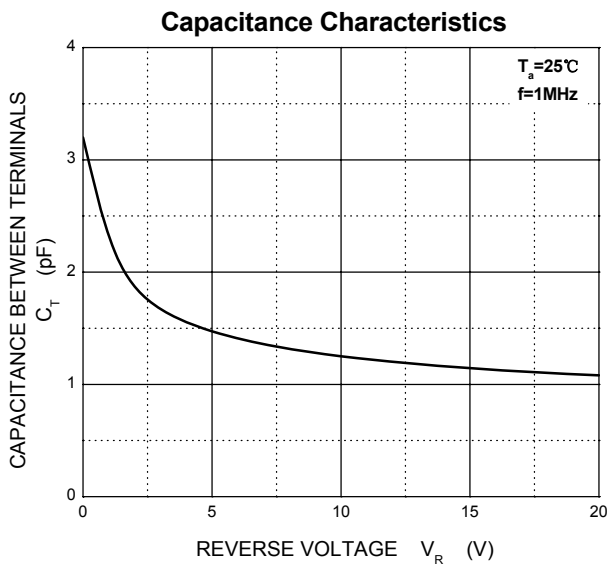
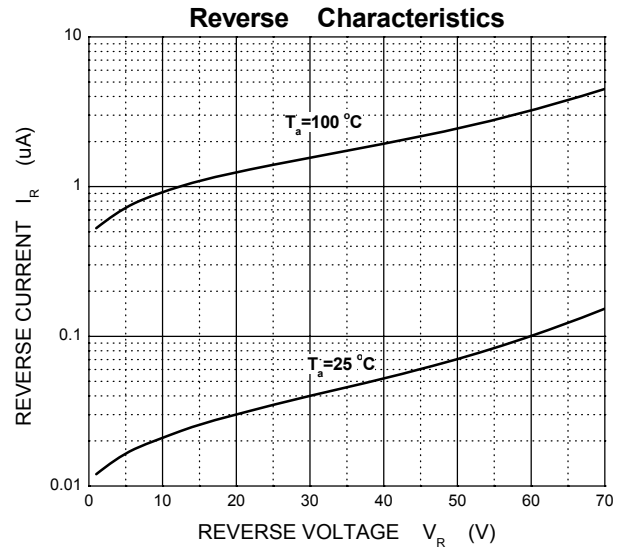
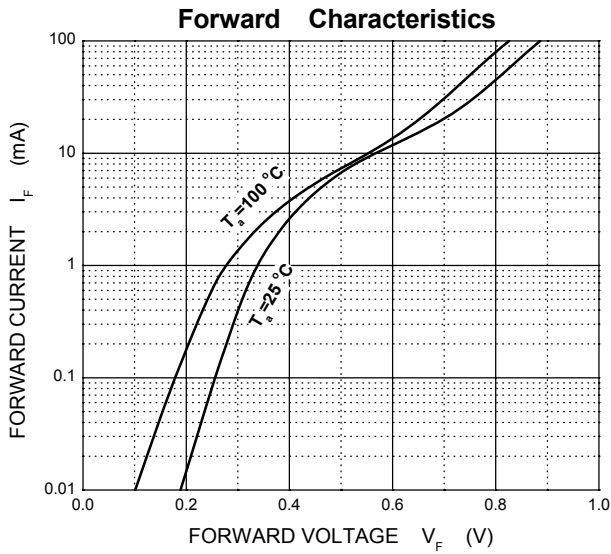

X-ON Electronics

Largest Supplier of Electrical and Electronic Components

Click to view similar products for [Diodes - General Purpose, Power, Switching category](#):

Click to view products by [AnBon manufacturer](#):

Other Similar products are found below :

[MCL4151-TR3](#) [MMBD3004S-13-F](#) [RD0306T-H](#) [RD0506LS-SB-1H](#) [RGP30G-E373](#) [DSE010-TR-E](#) [BAQ333-TR](#) [BAQ335-TR](#) [BAQ33-GS18](#) [BAS1602VH6327XT](#) [BAV17-TR](#) [BAV19-TR](#) [BAV301-TR](#) [BAW27-TAP](#) [HSC285TRF-E](#) [NSVBAV23CLT1G](#) [NTE525](#) [1SS181-TP](#) [1SS184-TP](#) [1SS193,LF](#) [1SS193-TP](#) [1SS400CST2RA](#) [SBAV99LT3G](#) [SDAA13](#) [LL4448-GS18](#) [SHN2D02FUTW1T1G](#) [LS4150GS18](#) [LS4151GS08](#) [SMMD7000LT3G](#) [FC903-TR-E](#) [1N4449](#) [1N4934-E3/73](#) [1SS226-TP](#) [APT100DL60HJ](#) [RFUH20TB3S](#) [RGP30G-E354](#) [RGP30M-E3/73](#) [D291S45T](#) [MCL4151-TR](#) [BAS 16-02V H6327](#) [BAS 21U E6327](#) [BAS 28 E6327](#) [BAS33-TAP](#) [BAS 70-02V H6327](#) [BAV300-TR](#) [BAV303-TR3](#) [BAW27-TR](#) [BAW56DWQ-7-F](#) [BAW56M3T5G](#) [BAW75-TAP](#)