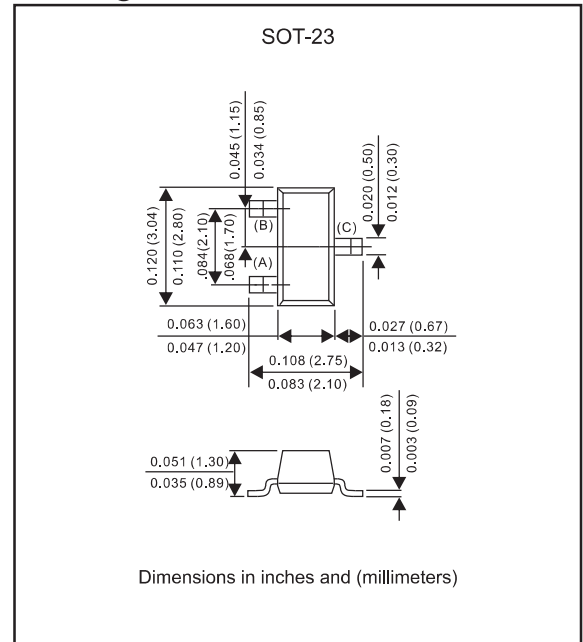

**BAT54 / BAT54A / BAT54C / BAT54S****200mA Surface Mount Small Signal Schottky Diodes-30V****Features**

- Low current rectification and high speed switching.
- Small surface mount type.
- Up to 200mA current capability.
- Low forward voltage drop.
- Silicon epitaxial planar chip, metal silicon junction.
- Lead-free parts for green partner, exceeds environmental standards of MIL-STD-19500 /228
- High speed ( trr < 5 ns )
- Suffix "-H" indicates Halogen-free part, ex.BAT54-H.

**Mechanical data**

- Epoxy:UL94-V0 rated flame retardant
- Case : Molded plastic, SOT-23
- Terminals : Solder plated, solderable per MIL-STD-750, Method 2026
- Mounting Position : Any

**Package outline****Maximum ratings and Electrical Characteristics** (AT  $T_A=25^\circ\text{C}$  unless otherwise noted)

PARAMETER	CONDITIONS	Symbol	MIN.	TYP.	MAX.	UNIT
Repetitive peak reverse voltage		$V_{RRM}$			30	V
Reverse voltage		$V_R$			30	V
Total Device dissipation	FR-5 board, (Note 1) $T_A = 25^\circ\text{C}$ Derate above $25^\circ\text{C}$	$P_D$			200 2.0	mW mW/ $^\circ\text{C}$
Repetitive peak forward current		$I_{FRM}$			300	mA
Forward surge current	$t_p < 1\text{s}$	$I_{FSM}$			600	mA
Forward current		$I_F$			200	mA
Thermal Resistance	Junction to ambient	$R_{\theta JA}$		500		$^\circ\text{C}/\text{W}$
Operating Junction temperature range		$T_J$	-55		+125	$^\circ\text{C}$
Storage temperature range		$T_{STG}$	-55		+125	$^\circ\text{C}$
Forward voltage	$I_F = 0.1\text{ mA}$	$V_F$		0.220	0.240	V
	$I_F = 1\text{ mA}$	$V_F$		0.290	0.320	V
	$I_F = 10\text{ mA}$	$V_F$		0.350	0.400	V
	$I_F = 30\text{ mA}$	$V_F$		0.410	0.500	V
	$I_F = 100\text{ mA}$	$V_F$		0.520	1.000	V
Reverse current	$V_R = 25\text{ V}$	$I_R$		0.5	2.0	$\mu\text{A}$
Diode capacitance	$V_R = 1\text{ V}$ , $f = 1\text{ MHz}$	$C_J$		7.6	10.0	pF
Reverse recovery time	$I_F = I_R = 10\text{ mAdc}$ , $I_{R(REC)} = 1.0\text{ mAdc}$	trr			5	ns

Note : 1.FR-5 = 1.0 x 0.75 x 0.062 in

## Rating and characteristic curves for each diode (BAT54 / A / C / S)

FIG.1-TYPICAL FORWARD CHARACTERISTICS

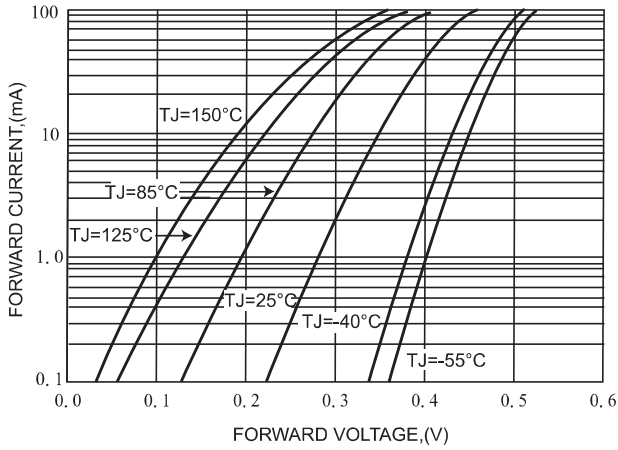

FIG.2 - TYPICAL LEAKAGE CURRENT CHARACTERISTICS

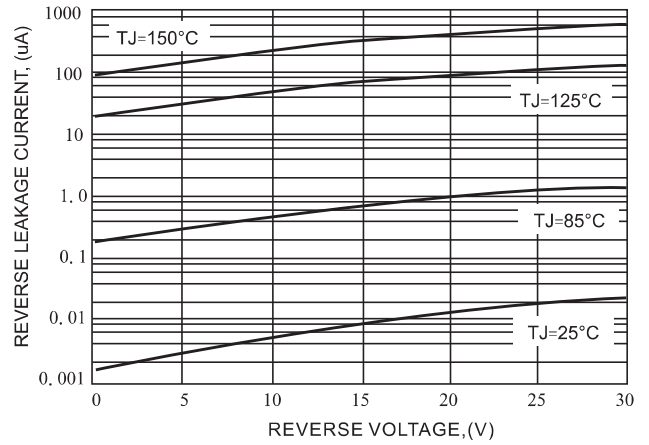
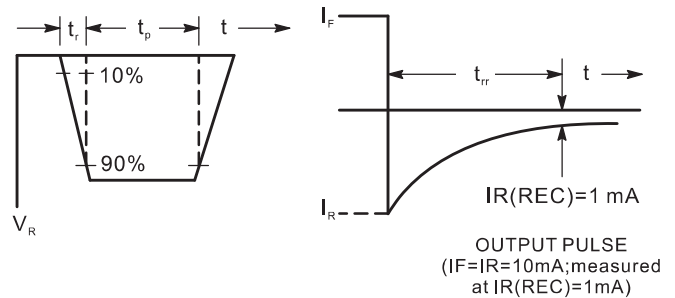
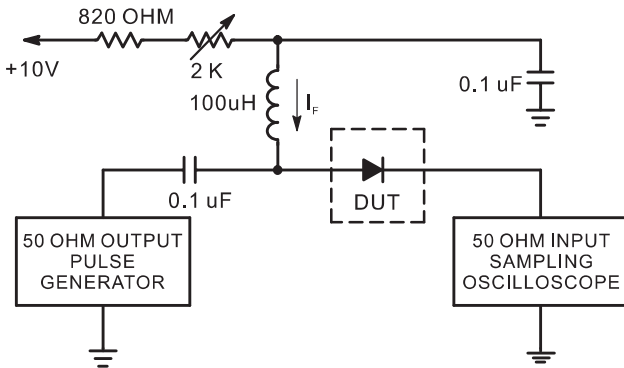
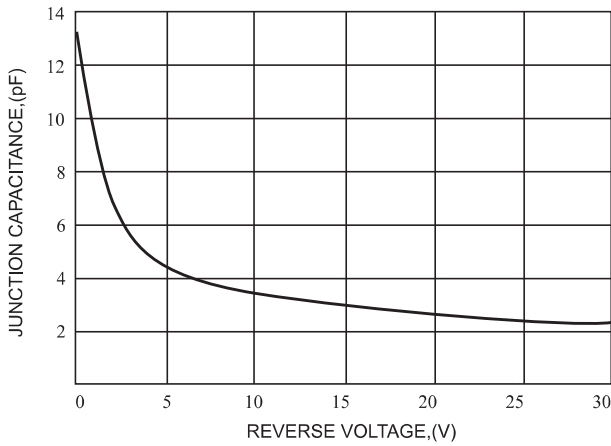

FIG.3-TYPICAL JUNCTION CAPACITANCE



- Notes : 1. A2.0 Kohm variable resistor adjusted for a forward Current ( $I_F$ ) of 10mA.  
 2. Input pulse is adjusted so  $I_R(\text{peak})$  is equal to 10 mA.  
 3.  $t_p \gg t_{rr}$ .

### Recovery Time Equivalent Test Circuit

# BAT54 / BAT54A / BAT54C / BAT54S

## Pinning information

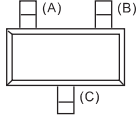
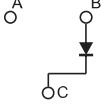
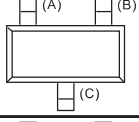
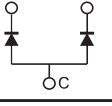
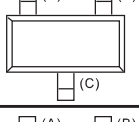
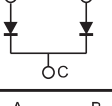
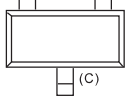
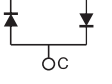
Type number	Marking code	Simplified outline	Symbol
BAT54	JV3, LV3, L4, KL1		
BAT54A	B6, L42, KL2		
BAT54C	5C, KL3, L43		
BAT54S	LD3, L44, KL4		

## Suggested solder pad layout

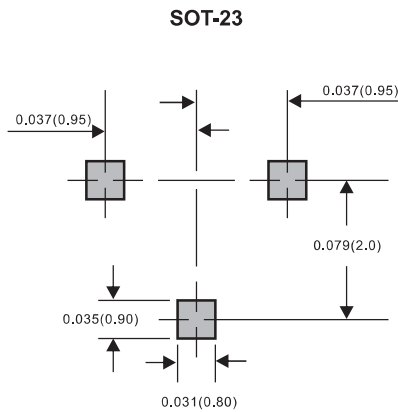

Dimensions in inches and (millimeters)

## Reel packing

PACKAGE	REEL SIZE	REEL (pcs)	COMPONENT SPACING (m/m)	BOX (pcs)	INNER BOX (m/m)	REEL DIA, (m/m)	CARTON SIZE (m/m)	CARTON (pcs)	APPROX. GROSS WEIGHT (kg)
SOT-23	7"	3,000	4.0	30,000	183*183*123	178	382*262*387	240,000	11.6

## X-ON Electronics

Largest Supplier of Electrical and Electronic Components

*Click to view similar products for [Schottky Diodes & Rectifiers](#) category:*

*Click to view products by [AnBon](#) manufacturer:*

Other Similar products are found below :

[CUS06\(TE85L,Q,M\)](#) [MA4E2039](#) [D1FH3-5063](#) [MBR0530L-TP](#) [MBR10100CT-BP](#) [MBR30H100MFST1G](#) [MMBD301M3T5G](#) [PMAD1103-LF](#) [PMAD1108-LF](#) [RB160M-50TR](#) [RB520S-30](#) [RB551V-30](#) [DD350N18K](#) [DZ435N40K](#) [DZ600N16K](#) [BAS16E6433HTMA1](#) [BAS 3010S-02LRH E6327](#) [BAT 54-02LRH E6327](#) [IDL02G65C5XUMA1](#) [NSR05F40QNXT5G](#) [NSVR05F40NXT5G](#) [JANS1N6640](#) [SB07-03C-TB-H](#) [SB1003M3-TL-W](#) [SBAT54CWT1G](#) [SBM30-03-TR-E](#) [SBS818-TL-E](#) [SK32A-LTP](#) [SK33A-TP](#) [SK34A-TP](#) [SK34B-TP](#) [SMD1200PL-TP](#) [ACDBN160-HF](#) [SS3003CH-TL-E](#) [STPS30S45CW](#) [PDS3100Q-7](#) [GA01SHT18](#) [CRS10I30A\(TE85L,QM\)](#) [MBR1240MFST1G](#) [MBRB30H30CT-1G](#) [BAS28E6433HTMA1](#) [BAS 70-02L E6327](#) [HSB123JTR-E](#) [JANTX1N5712-1](#) [VS-STPS40L45CW-N3](#) [DD350N12K](#) [SB007-03C-TB-E](#) [SB10015M-TL-E](#) [SB1003M3-TL-E](#) [SK110-LTP](#)