

**Multilayer Chip Ferrite Bead**



◆ **Features**

- 1、 Internal silver printed layers and magnetic shielded structures to minimize crosstalk
- 2、 It has sharp impedance characteristics at desirable frequency and does not affect the signal frequency
- 3、 SMD Type & suitable for reflow and wave soldering
- 4、 Four types material and wide range of impedance values for various applications
- 5、 Excellent solderability and heat resistance
- 6、 RoHS Compliant.



◆ **Application**

Filtering between analog and digital circuitry, clock Generation circuitry, I/O interconnects, isolation between RF noisy circuits and logic devices susceptible to functional degradation, power supply filtering to prevent conducted RF energy from corrupting the power generation circuitry, high frequency EMI prevention of computer, printers, VCRs, TVs and portable telephones.

◆ **PRODUCT IDENTIFICATION**

**CMBM 1005 K 600 H S P**  
**(1) (2) (3) (4) (5) (6) (7)**

- (1) Series Type
- (2) Chip Size (mm) :Length X Width
- (3) Material Code
- (4) Nominal Impedance:601=600Ω;  
102=1000Ω
- (5) Rated Curren: A=50mA; B=100mA;C=150mA;  
D=200mA;E=300mA;F=400mA;  
G=500mA;H=600mA;I=700mA;  
J=800mA;K=900mA;L=1000mA.
- (6) Company Code
- (7) Packaging: E- Embossed plastic tape, 7" reel  
P – Embossed paper tape, 7" reel

◆ **Dimensions**      Unit: mm

Size(EIA)	L	W	T	E
1005(0402)	1.00±0.10	0.50±0.10	0.50±0.10	0.25±0.10

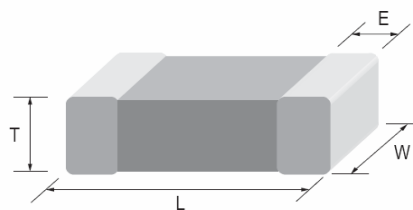

◆ **Specification**

Part Number	Impedance (Ω)	Test Frequency (MHz)	DCR Max. (Ω)	Rated Current (mA)
<b>CMBM1005 Series</b>				
CMBM1005G050HSP	0~15	100	0.15	600
CMBM1005G300HSP	30±25%	100	0.15	600
CMBM1005G470HSP	47±25%	100	0.15	600
CMBM1005G600HSP	60±25%	100	0.20	600
CMBM1005G700HSP	70±25%	100	0.30	600
CMBM1005G101GSP	100±25%	100	0.35	500
CMBM1005G121GSP	120±25%	100	0.40	500
CMBM1005G221GSP	220±25%	100	0.70	500
CMBM1005K301GSP	300±25%	100	0.80	500
CMBM1005K601GSP	600±25%	100	1.00	500
CMBM1005K102ESP	1000±25%	100	1.20	300
CMBM1005B152BSP	1500±25%	100	1.40	100
CMBM1005B182ASP	1800±25%	100	1.80	50

◆ **General Technical Data**

<b>Operating Temperature Range</b>	-55°C ~ +125°C
<b>Storage Condition</b>	Less than 40°C and 70% RH
<b>Soldering Method</b>	Reflow or Wave Soldering

◆ **Recommended Soldering Conditions**

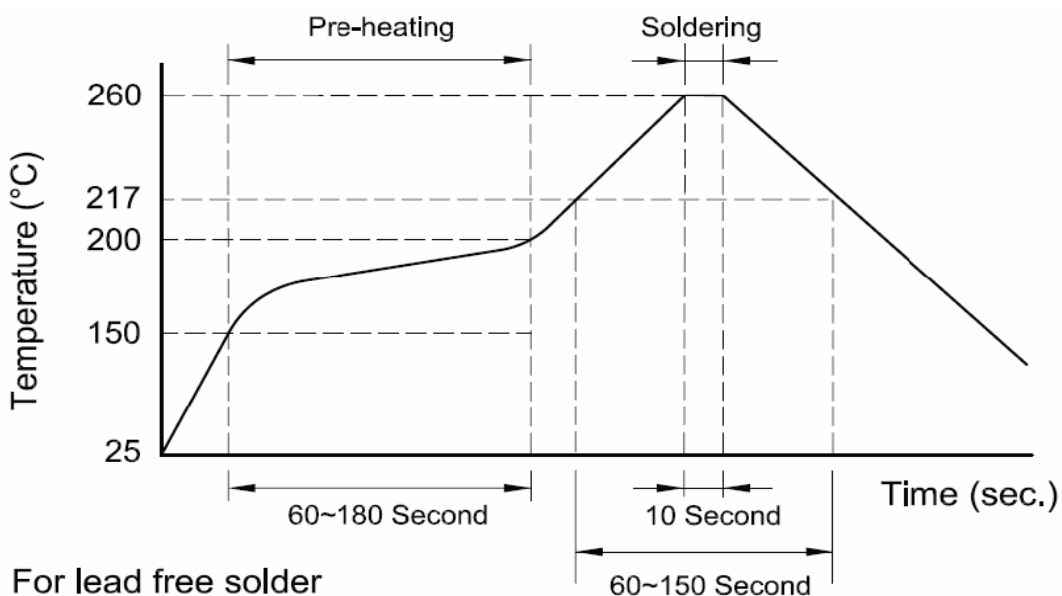

◆ Characteristics

**CMBM1005 TYPE**

CMBM1005G050HSP

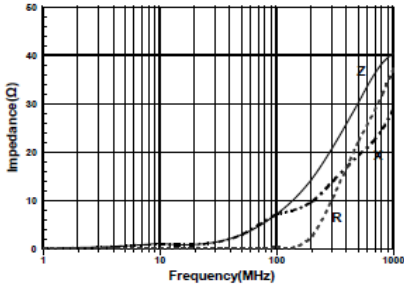

CMBM1005G300HSP

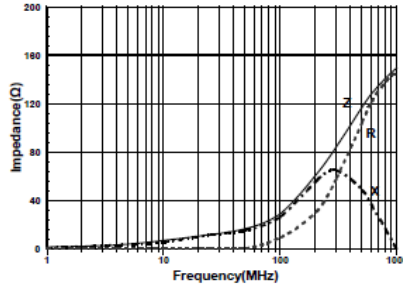

CMBM1005G600HSP

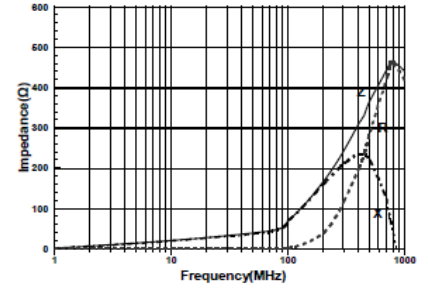

CMBM1005K121GSP

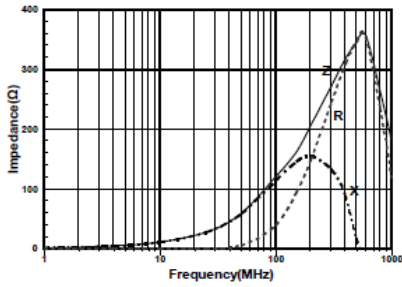

CMBM1005K221GSP

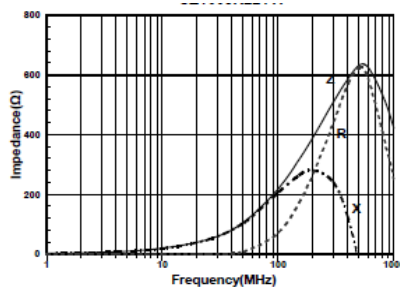

CMBM1005K301GSP

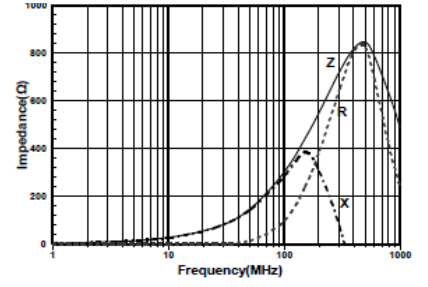

CMBM1005K421GSP

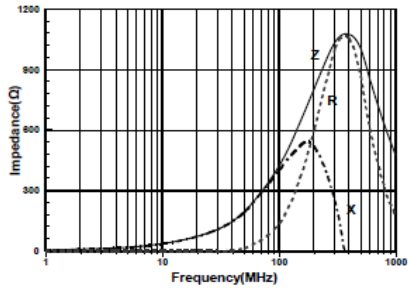

CMBM1005K601GSP

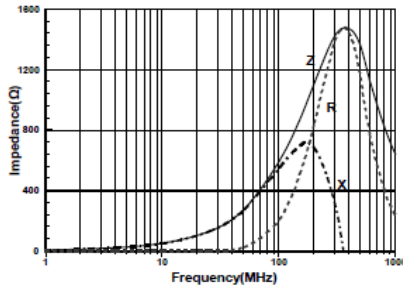

CMBM1005K102ESP

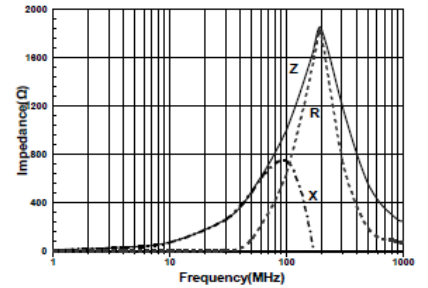

CMBM1005B152BSP

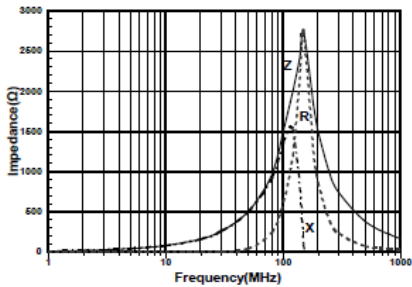

CMBM1005B182ASP

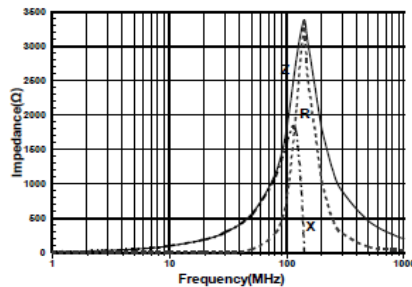

◆ **Packaging**

Tape Carrier Packaging:

Packaging code: T

- a. Tape carrier packaging are specified in attached figure
- b. Tape carrier packaging quantity please see the following table

Type	1005(0402)
T(mm)	0.5±0.15
Tape	Paper Tape
Quantity	10K

(1) Taping Drawings (Unit: mm)

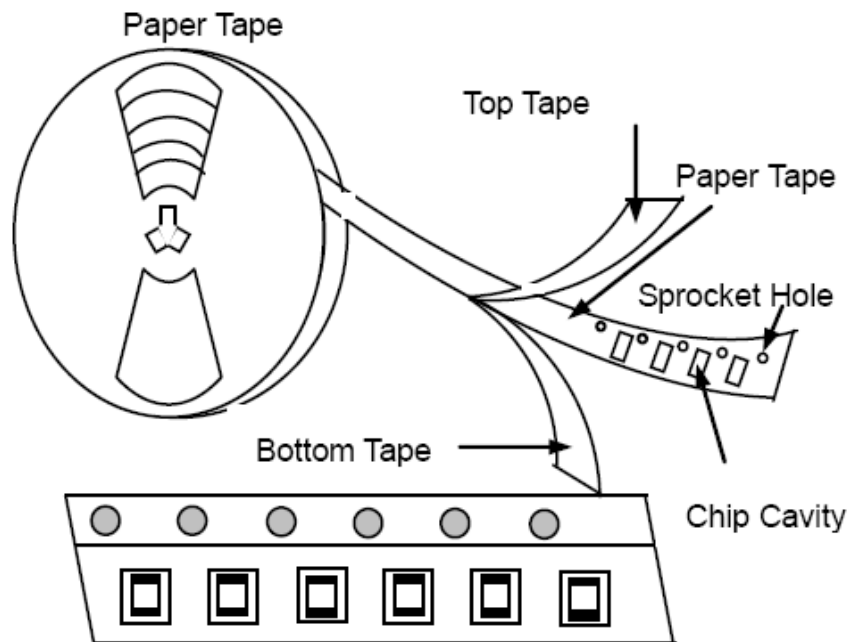

**Remark:** The sprocket holes are to the right as the tape is pulled toward the user.

(2) Taping Dimensions (Unit: mm)

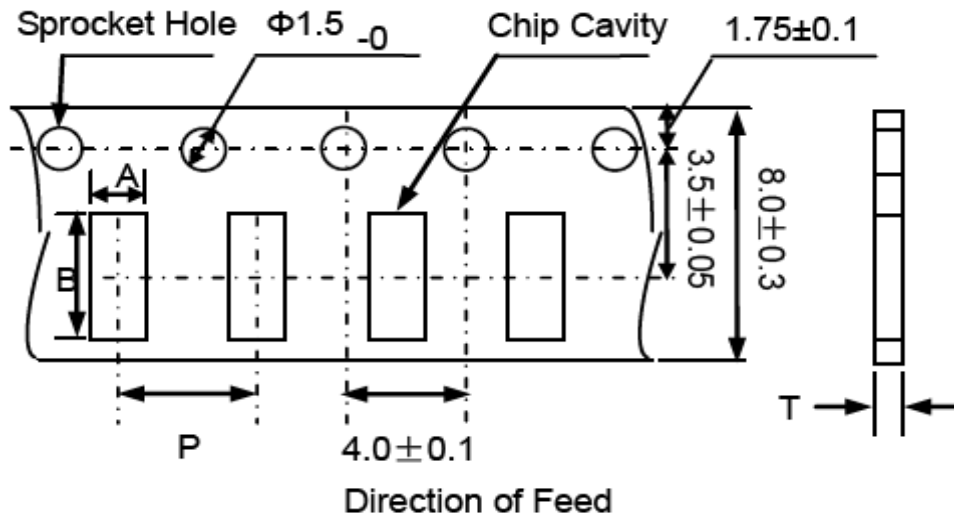

Paper Tape

Type	A	B	P	T max
1005(0402)	$0.65 \pm 0.1$	$1.15 \pm 0.1$	$2.0 \pm 0.05$	0.8

(3) Reel Dimensions (Unit: mm)

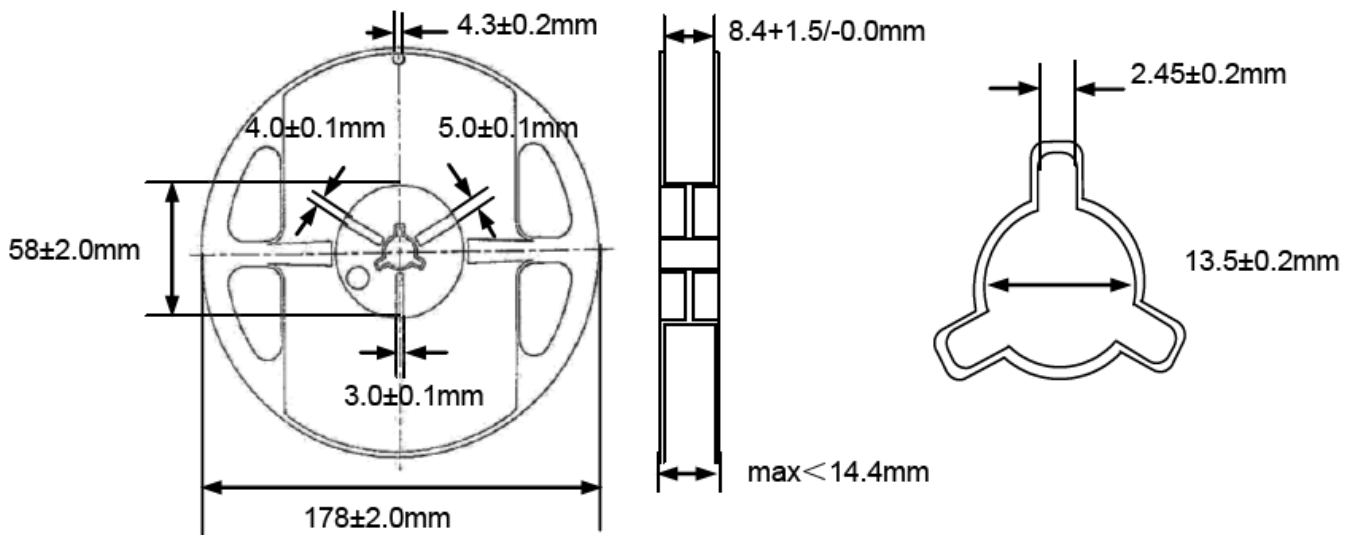

## X-ON Electronics

Largest Supplier of Electrical and Electronic Components

*Click to view similar products for [Ferrite Beads](#) category:*

*Click to view products by [Cybermax](#) manufacturer:*

Other Similar products are found below :

[2943778301](#) [BMB1J0120BN3JIT](#) [82350120560](#) [0261014605](#) [2643066902](#) [3061000011](#) [2673045901](#) [2643083601](#) [2643074901](#) [4361142521](#)  
[4078078621](#) [4078044821](#) [4078033621](#) [CZB2BFTTE121P](#) [BMB2A0120AN2](#) [BMB1J0200BN3JIT](#) [EMI0805R-220](#) [74279250](#) [7427924](#)  
[CZB1JGTTD202P](#) [MAF0603GWY551AT000](#) [MAF1005GWZ102AT000](#) [BLM18HE152SH1D](#) [2944778302](#) [BLM02PX600SN1D](#) [SMB2.5-1](#)  
[EMI1206R-600](#) [BLM02KX180SN1D](#) [BLM02BC100SN1D](#) [BLM02KX100SN1D](#) [BLM02BB101SN1D](#) [BLM02BC220SN1D](#)  
[BLE32PN260SH1L](#) [BLE32PN260SN1L](#) [BLE32PN260SZ1L](#) [74275013](#) [7427503](#) [BLM18HE601SH1D](#) [BLM15BD152SN1D](#)  
[BLM15BD152SZ1D](#) [BLE18PS080SZ1D](#) [BLM21PG221BH1D](#) [WLBD1005HCU330TL](#) [BLM21AG471BH1D](#) [BLE18PS080BH1D](#)  
[BLM21AG331BH1D](#) [BLM21PG300BH1D](#) [BLM21PG600BH1D](#) [BLM03HB401SZ1D](#) [BLM03HB401SN1D](#)