

# FODM3011, FODM3012, FODM3022, FODM3023, FODM3052, FODM3053

## 4-Pin Full Pitch Mini-Flat Package Random-Phase Triac Driver Output Optocouplers

### Features

- Compact 4-pin surface mount package (2.4 mm maximum standoff height)
- Peak blocking voltage  
250V (FODM301X)  
400V (FODM302X)  
600V (FODM305X)
- Available in tape and reel quantities of 2500.
- Add "NF098" for new construction version with 260°C max. reflow temperature rating
- UL, C-UL and VDE certifications pending

### Applications

- Industrial controls
- Traffic lights
- Vending machines

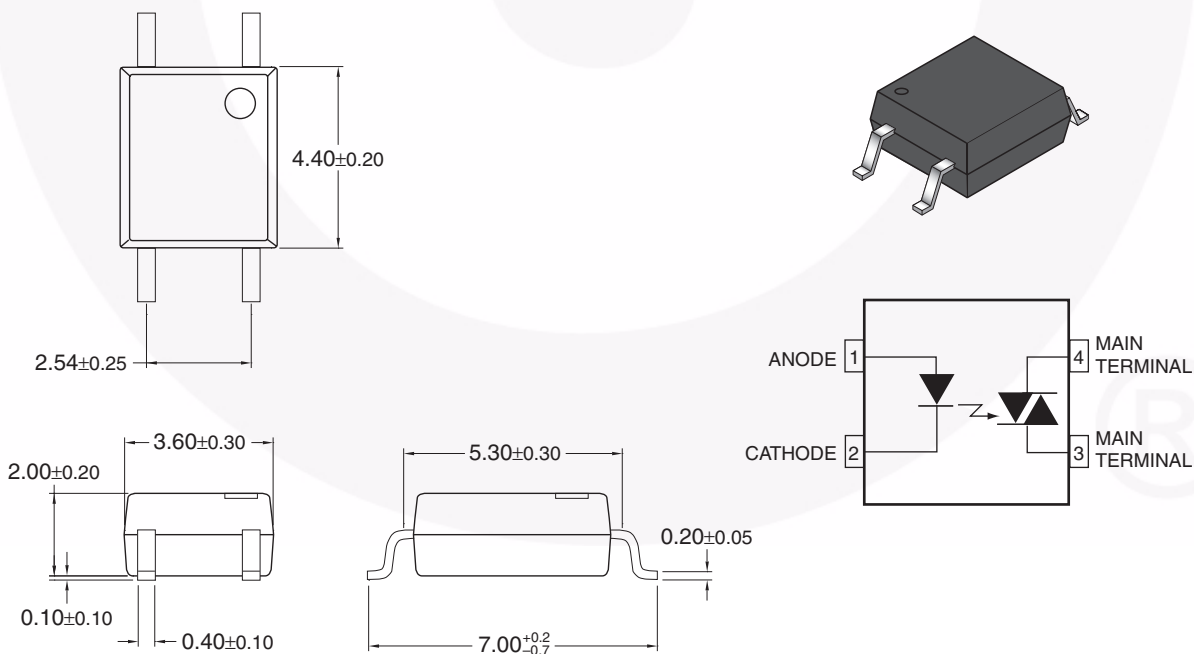
### Applications (Continued)

- Solid state relay
- Lamp ballasts
- Solenoid/valve controls
- Static AC power switch
- Incandescent lamp dimmers
- Motor control

### Description

The FODM301X, FODM302X, and FODM305X series consists of a GaAs infrared emitting diode driving a silicon bilateral switch housed in a compact 4-pin mini-flat package. The lead pitch is 2.54mm. They are designed for interfacing between electronic controls and power triacs to control resistive and inductive loads for 115V/240V operations.

### Package Dimensions



#### Note:

All dimensions are in millimeters.

**Absolute Maximum Ratings** ( $T_A = 25^\circ\text{C}$  unless otherwise specified)

Stresses exceeding the absolute maximum ratings may damage the device. The device may not function or be operable above the recommended operating conditions and stressing the parts to these levels is not recommended. In addition, extended exposure to stresses above the recommended operating conditions may affect device reliability. The absolute maximum ratings are stress ratings only.

Symbol	Parameter	Value	Units
<b>TOTAL PACKAGE</b>			
$T_{STG}$	Storage Temperature	-55 to +150	$^\circ\text{C}$
$T_{OPR}$	Operating Temperature	-40 to +100	$^\circ\text{C}$
<b>EMITTER</b>			
$I_F$ (avg)	Continuous Forward Current	60	mA
$I_F$ (pk)	Peak Forward Current (1 $\mu\text{s}$ pulse, 300pps.)	1	A
$V_R$	Reverse Input Voltage	3	V
$P_D$	Power Dissipation (No derating required over operating temp. range)	100	mW
<b>DETECTOR</b>			
$I_{T(RMS)}$	On-State RMS Current	70	mA (RMS)
$V_{DRM}$	Off-State Output Terminal Voltage	FODM3011/FODM3012	250
		FODM3022/FODM3023	400
		FODM3052/FODM3053	600
$P_D$	Power Dissipation (No derating required over operating temp. range)	300	mW

**Electrical Characteristics** ( $T_A = 25^\circ\text{C}$ )**Individual Component Characteristics**

Symbol	Parameter	Test Conditions	Device	Min.	Typ.*	Max.	Unit
<b>EMITTER</b>							
$V_F$	Input Forward Voltage	$I_F = 10\text{mA}$	All		1.20	1.5	V
$I_R$	Reverse Leakage Current	$V_R = 3\text{V}, T_A = 25^\circ\text{C}$	All		0.01	100	$\mu\text{A}$
<b>DETECTOR</b>							
$I_{\text{DRM}}$	Peak Blocking Current Either Direction	Rated $V_{\text{DRM}}, I_F = 0^{(1)}$	All		2	100	nA
dV/dt	Critical Rate of Rise of Off-State Voltage	$I_F = 0$ (Figure 8) <sup>(2)</sup>	FODM3011, FODM3012, FODM3022, FODM3023		10		V/ $\mu\text{s}$
			FODM3052, FODM3053	1,000			

**Transfer Characteristics**

Symbol	DC Characteristics	Test Conditions	Device	Min.	Typ.*	Max.	Unit
$I_{\text{FT}}$	LED Trigger Current	Main Terminal Voltage = $3\text{V}^{(3)}$	FODM3011, FODM3022, FODM3052			10	mA
			FODM3012, FODM3023, FODM3053			5	
$I_H$	Holding Current, Either Direction		All		300		$\mu\text{A}$
$V_{\text{TM}}$	Peak On-State Voltage Either Direction	$I_{\text{TM}} = 100\text{mA}$ peak	All		1.7	3	V

**Isolation Characteristics**

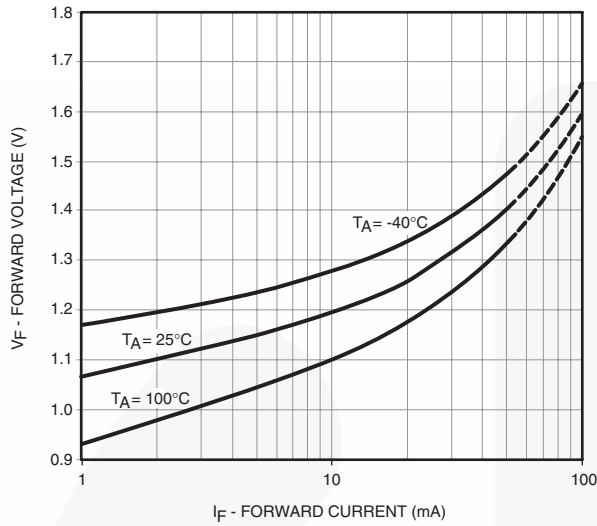
Symbol	Characteristic	Test Conditions	Device	Min.	Typ.*	Max.	Unit
$V_{\text{ISO}}$	Steady State Isolation Voltage	1 Minute, R.H. = 40% to 60%	All	3750			VRMS

\*All typicals at  $T_A = 25^\circ\text{C}$ **Notes:**

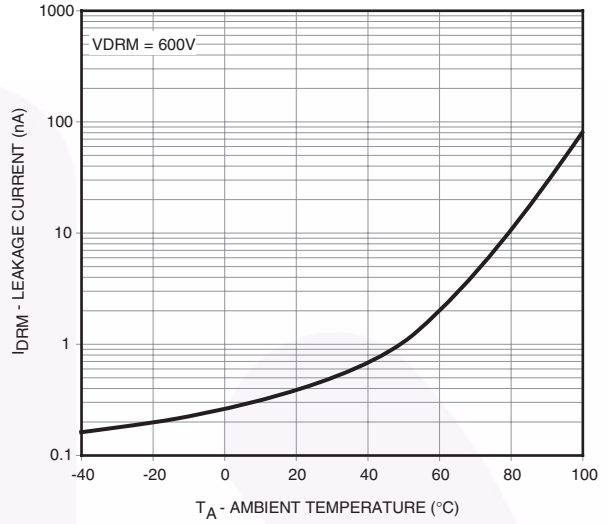
1. Test voltage must be applied within dv/dt rating.
2. This is static dv/dt. See Figure 1 for test circuit. Commutating dv/dt is function of the load-driving thyristor(s) only.
3. All devices are guaranteed to trigger at an  $I_F$  value less than or equal to max  $I_{\text{FT}}$ . Therefore, recommended operating  $I_F$  lies between max  $I_{\text{FT}}$  (10mA for FODM3011, FODM3022, and FODM3052, 5mA for FODM3012, FODM3023, and FODM3053) and absolute max  $I_F$  (60mA).

## Typical Performance Curves

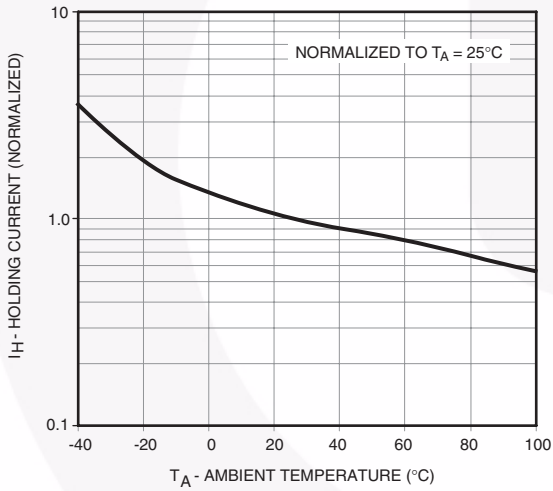
**Fig. 1 LED Forward Voltage vs. Forward Current**



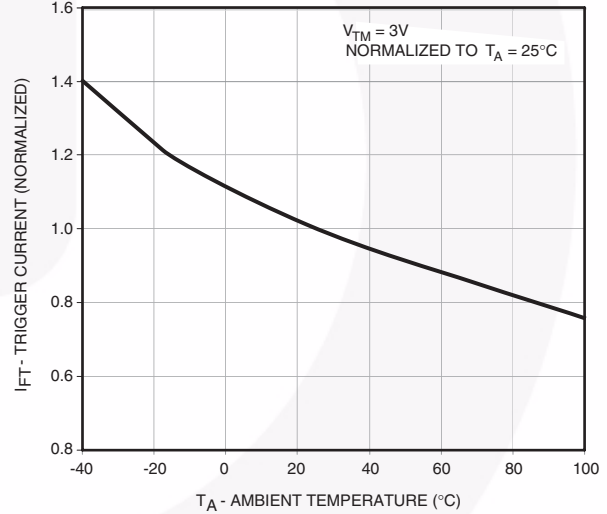
**Fig. 2 Leakage Current vs. Ambient Temperature**



**Fig. 3 Holding Current vs. Ambient Temperature**

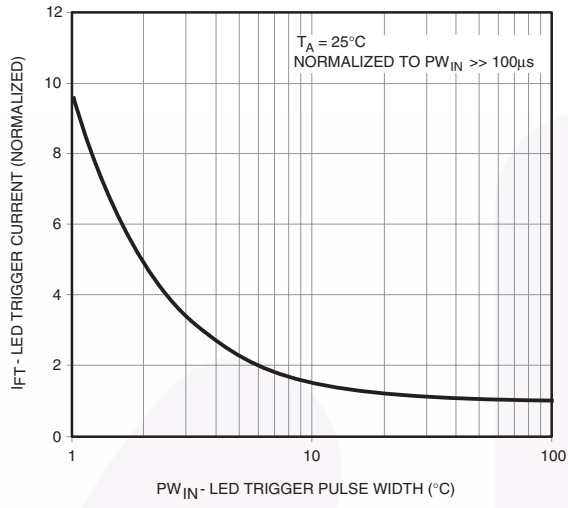


**Fig. 4 Trigger Current vs. Ambient Temperature**

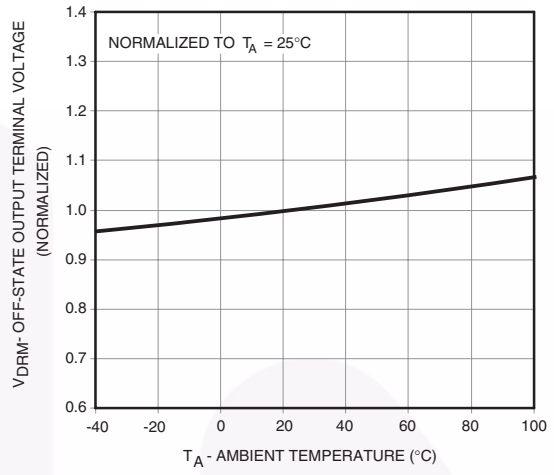


## Typical Performance Curves (Continued)

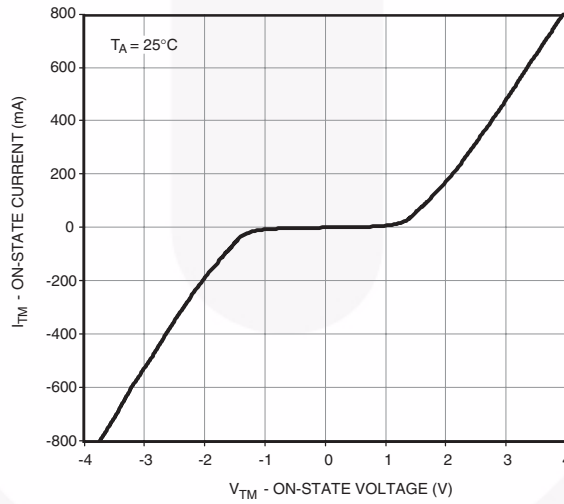
**Fig. 5 LED Current Required to Trigger vs. LED Pulse Width**



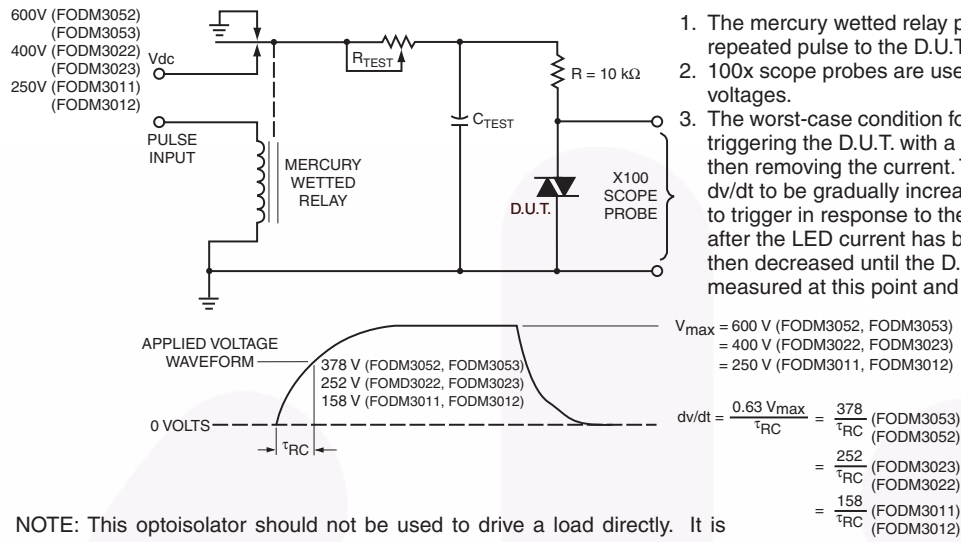
**Fig. 6 Off-State Output Terminal Voltage vs. Ambient Temperature**



**Fig. 7 On-State Characteristics**



## Typical Application Information



1. The mercury wetted relay provides a high speed repeated pulse to the D.U.T.
2. 100x scope probes are used, to allow high speeds and voltages.
3. The worst-case condition for static dv/dt is established by triggering the D.U.T. with a normal LED input current, then removing the current. The variable  $R_{TEST}$  allows the dv/dt to be gradually increased until the D.U.T. continues to trigger in response to the applied voltage pulse, even after the LED current has been removed. The dv/dt is then decreased until the D.U.T. stops triggering.  $\tau_{RC}$  is measured at this point and recorded.

NOTE: This optoisolator should not be used to drive a load directly. It is intended to be a trigger device only.

Figure 8. Static dv/dt Test Circuit

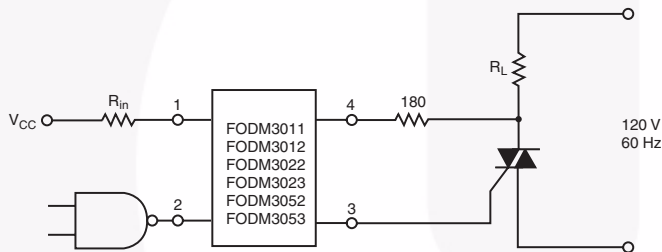


Figure 9. Resistive Load

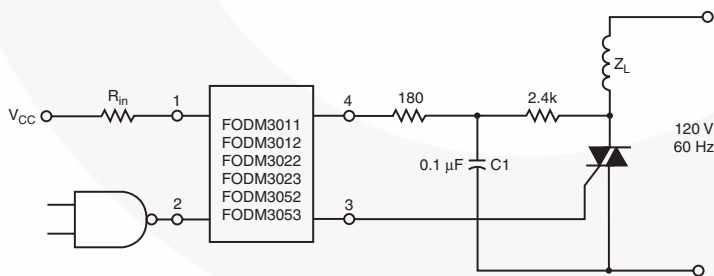
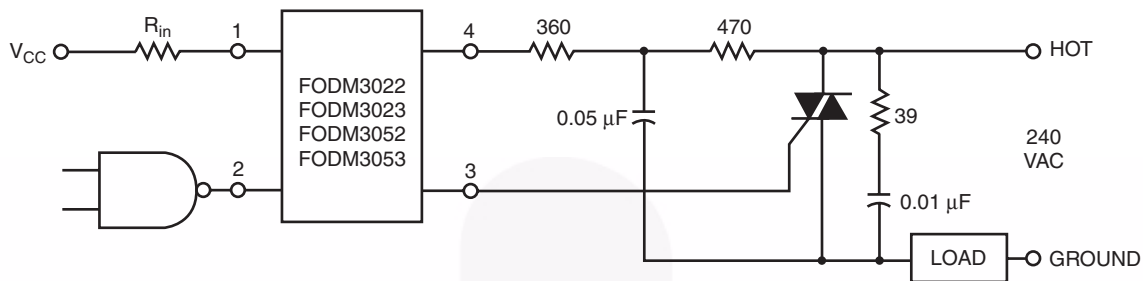


Figure 10. Inductive Load with Sensitive Gate Triac ( $I_{GT} \leq 15\text{ mA}$ )

**Typical Application Information** (Continued)



In this circuit the “hot” side of the line is switched and the load connected to the cold or ground side.

The 39Ω resistor and 0.01μF capacitor are for snubbing of the triac, and the 470Ω resistor and 0.05μF capacitor are for snubbing the coupler. These components may or may not be necessary depending upon the particular and load used.

**Figure 11. Typical Application Circuit**

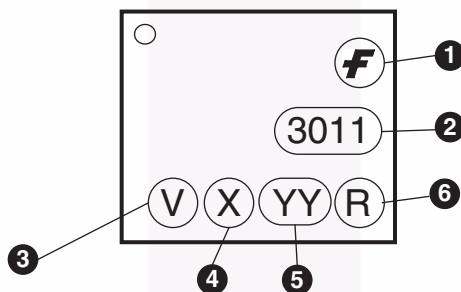
## Ordering Information

Option	Description
V_NF098	VDE Approved
R2_NF098	Tape and Reel (2500 units)
R2V_NF098	Tape and Reel (2500 units) and VDE Approved

### Note:

To specify the new construction version with 260°C max reflow peak temperature rating: Add "NF098" to the end of the part number. The non NF098 version is rated for 230°C peak reflow temperature.

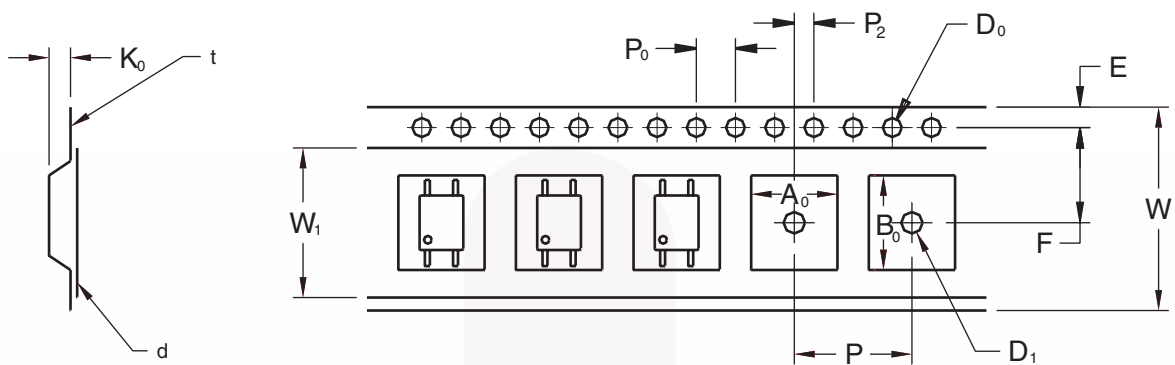
## Marking Information



Definitions	
1	Fairchild logo
2	Device number
3	VDE mark (Note: Only appears on parts ordered with VDE option – See order entry table)
4	One digit year code
5	Two digit work week ranging from '01' to '53'
6	Assembly package code

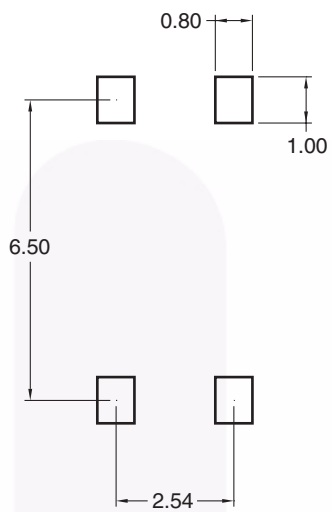


## Tape Specifications



		2.54 Pitch
Description	Symbol	Dimensions
Tape Width	W	12.00±0.4
Tape Thickness	t	0.35±0.02
Sprocket Hole Pitch	P <sub>0</sub>	4.00±0.20
Sprocket Hole Dia.	D <sub>0</sub>	1.55±0.20
Sprocket Hole Location	E	1.75±0.20
Pocket Location	F	5.50±0.20
	P <sub>2</sub>	2.00±0.20
Pocket Pitch	P	8.00±0.20
Pocket Dimension	A <sub>0</sub>	4.75±0.20
	B <sub>0</sub>	7.30±0.20
	K <sub>0</sub>	2.30±0.20
Pocket Hole Dia.	D <sub>1</sub>	1.55±0.20
Cover Tape Width	W <sub>1</sub>	9.20
Cover Tape Thickness	d	0.065±0.02
Max. Component Rotation or Tilt		20° max
Devices Per Reel		2500
Reel Diameter		330 mm (13")

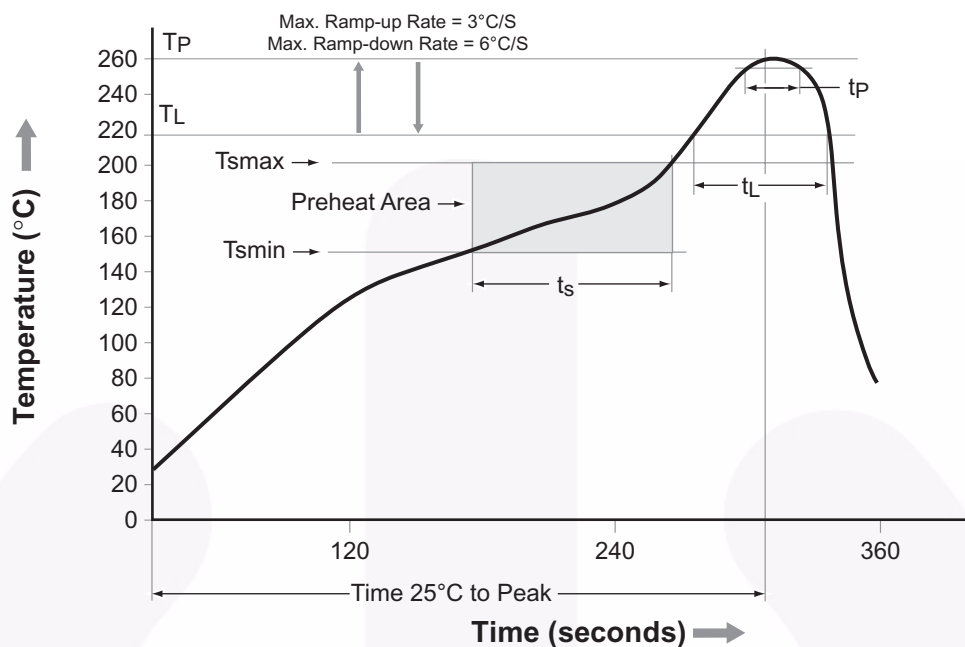
### Footprint Drawing for PCB Layout



**Note:**  
All dimensions are in mm.



## Reflow Profile




Profile Feature	Pb-Free Assembly Profile
Temperature Min. (T <sub>smin</sub> )	150°C
Temperature Max. (T <sub>smax</sub> )	200°C
Time (t <sub>s</sub> ) from (T <sub>smin</sub> to T <sub>smax</sub> )	60–120 seconds
Ramp-up Rate (t <sub>L</sub> to t <sub>p</sub> )	3°C/second max.
Liquidous Temperature (T <sub>L</sub> )	217°C
Time (t <sub>L</sub> ) Maintained Above (T <sub>L</sub> )	60–150 seconds
Peak Body Package Temperature	260°C +0°C / -5°C
Time (t <sub>p</sub> ) within 5°C of 260°C	30 seconds
Ramp-down Rate (T <sub>P</sub> to T <sub>L</sub> )	6°C/second max.
Time 25°C to Peak Temperature	8 minutes max.



**TRADEMARKS**

The following includes registered and unregistered trademarks and service marks, owned by Fairchild Semiconductor and/or its global subsidiaries, and is not intended to be an exhaustive list of all such trademarks.

- |   |                        |   |   |
|---|------------------------|---|---|
| Auto-SPM™   | F-PFS™                 | PowerTrench®  | The Power Franchise®  |
| Build it Now™   | FRFET®                 | PowerXS™  | the power franchise   |
| CorePLUS™   | Global Power Resource™ | Programmable Active Droop™  | QFET™   |
| CorePOWER™  | Green FPS™             | Quiet Series™   | TinyBoost™  |
| CROSSVOLT™  | Green FPS™ e-Series™   | QST™  | TinyBuck™   |
| CTL™  | Gmax™                  | RapidConfigure™   | TinyLogic®  |
| Current Transfer Logic™   | GTO™                   |   | TINYOPTO™   |
| EcoSPARK®   | IntelliMAX™            |  | TinyPower™  |
| EfficientMax™   | ISOPLANAR™             | Saving our world, 1mW/W/kW at a time™   | TinyPWM™  |
| EZSWITCH™*  | MegaBuck™              | SmartMax™   | TinyWire™   |
|  | MICROCOUPLER™          | SMART START™  | TriFault Detect™  |
|  | MicroFET™              | SPM®  | TRUECURRENT™*   |
| Fairchild®  | MicroPak™              | STEALTH™  | μSerDes™  |
| Fairchild Semiconductor®  | MillerDrive™           | SuperFET™   |  |
| FACT Quiet Series™  | MotionMax™             | SuperSOT™-3   | UHC®  |
| FACT®   | Motion-SPM™            | SuperSOT™-6   | Ultra FRFET™  |
| FAST®   | OPTOLOGIC®             | SuperSOT™-8   | UniFET™   |
| FastvCore™  | OPTOPLANAR®            | SupreMOS™   | VCX™  |
| FETBench™   |                        | SyncFET™  | VisualMax™  |
| FlashWriter®*   | PDP SPM™               | Sync-Lock™  | XS™   |
| FPS™  | Power-SPM™             |  |   |

\* Trademarks of System General Corporation, used under license by Fairchild Semiconductor.

**DISCLAIMER**

FAIRCHILD SEMICONDUCTOR RESERVES THE RIGHT TO MAKE CHANGES WITHOUT FURTHER NOTICE TO ANY PRODUCTS HEREIN TO IMPROVE RELIABILITY, FUNCTION, OR DESIGN. FAIRCHILD DOES NOT ASSUME ANY LIABILITY ARISING OUT OF THE APPLICATION OR USE OF ANY PRODUCT OR CIRCUIT DESCRIBED HEREIN; NEITHER DOES IT CONVEY ANY LICENSE UNDER ITS PATENT RIGHTS, NOR THE RIGHTS OF OTHERS. THESE SPECIFICATIONS DO NOT EXPAND THE TERMS OF FAIRCHILD'S WORLDWIDE TERMS AND CONDITIONS, SPECIFICALLY THE WARRANTY THEREIN, WHICH COVERS THESE PRODUCTS.

**LIFE SUPPORT POLICY**

FAIRCHILD'S PRODUCTS ARE NOT AUTHORIZED FOR USE AS CRITICAL COMPONENTS IN LIFE SUPPORT DEVICES OR SYSTEMS WITHOUT THE EXPRESS WRITTEN APPROVAL OF FAIRCHILD SEMICONDUCTOR CORPORATION.

As used herein:

- Life support devices or systems are devices or systems which, (a) are intended for surgical implant into the body or (b) support or sustain life, and (c) whose failure to perform when properly used in accordance with instructions for use provided in the labeling, can be reasonably expected to result in a significant injury of the user.
- A critical component in any component of a life support, device, or system whose failure to perform can be reasonably expected to cause the failure of the life support device or system, or to affect its safety or effectiveness.

**ANTI-COUNTERFEITING POLICY**

Fairchild Semiconductor Corporation's Anti-Counterfeiting Policy. Fairchild's Anti-Counterfeiting Policy is also stated on our external website, [www.fairchildsemi.com](http://www.fairchildsemi.com), under Sales Support.

Counterfeiting of semiconductor parts is a growing problem in the industry. All manufacturers of semiconductor products are experiencing counterfeiting of their parts. Customers who inadvertently purchase counterfeit parts experience many problems such as loss of brand reputation, substandard performance, failed applications, and increased cost of production and manufacturing delays. Fairchild is taking strong measures to protect ourselves and our customers from the proliferation of counterfeit parts. Fairchild strongly encourages customers to purchase Fairchild parts either directly from Fairchild or from Authorized Fairchild Distributors who are listed by country on our web page cited above. Products customers buy either from Fairchild directly or from Authorized Fairchild Distributors are genuine parts, have full traceability, meet Fairchild's quality standards for handling and storage and provide access to Fairchild's full range of up-to-date technical and product information. Fairchild and our Authorized Distributors will stand behind all warranties and will appropriately address any warranty issues that may arise. Fairchild will not provide any warranty coverage or other assistance for parts bought from Unauthorized Sources. Fairchild is committed to combat this global problem and encourage our customers to do their part in stopping this practice by buying direct or from authorized distributors.

**PRODUCT STATUS DEFINITIONS**

**Definition of Terms**

Datasheet Identification	Product Status	Definition
Advance Information	Formative / In Design	Datasheet contains the design specifications for product development. Specifications may change in any manner without notice.
Preliminary	First Production	Datasheet contains preliminary data; supplementary data will be published at a later date. Fairchild Semiconductor reserves the right to make changes at any time without notice to improve design.
No Identification Needed	Full Production	Datasheet contains final specifications. Fairchild Semiconductor reserves the right to make changes at any time without notice to improve the design.
Obsolete	Not In Production	Datasheet contains specifications on a product that is discontinued by Fairchild Semiconductor. The datasheet is for reference information only.

Rev. 140

## X-ON Electronics

Largest Supplier of Electrical and Electronic Components

*Click to view similar products for [Triac & SCR Output Optocouplers](#) category:*

*Click to view products by [ON Semiconductor](#) manufacturer:*

Other Similar products are found below :

[IL4218-X019](#) [MOC3063S-TA](#) [IL4108-X017](#) [IL410-X019T](#) [ILD207-X001T](#) [ILD615-1X007T](#) [VO2223-X001](#) [VO3063-X017T](#) [VO4254H](#)  
[WPPCT-N1066A](#) [WPPCT-N1566A](#) [WPPCT-Z546D](#) [523170E](#) [VO4256H-X007T](#) [VO4256D-X007T](#) [VO4254M](#) [VO3063-X016](#) [VO3062-](#)  
[X017T](#) [WPPCT-Z546A](#) [WPPCT-Z1046D](#) [WPPCT-Z1046A](#) [WPPCT-N566D](#) [WPPCT-N566A](#) [WPPCT-N1566D](#) [IL4108-X009T](#)  
[FODM3053V\\_NF098](#) [VO4258D](#) [VO4256D](#) [VO4257M](#) [VO4156D-X007T](#) [VO4154D-X007T](#) [VOM160R-X001T](#) [TLP3082\(S,C,F\)](#)  
[VO4156H-X006](#) [VO4158H-X017T](#) [IL4116-X009T](#) [IL4208-X017T](#) [TLP3083\(TP1,F](#) [MOC3071SM](#) [tlp548j](#) [MOC3063STA1-V](#)  
[TLP267J\(TPL,E](#) [IL4218-X017](#) [SFH690C-X001T](#) [IL410-X017](#) [IL410-X001](#) [VOM160P-X001T](#) [IL4116-X007](#) [IL4117-X007](#) [VO4258D-](#)  
[X007T](#)