

BN 20

Hexagon socket flat countersunk
head screws
fully threaded
fully threaded

DIN 7991
~ISO 10642

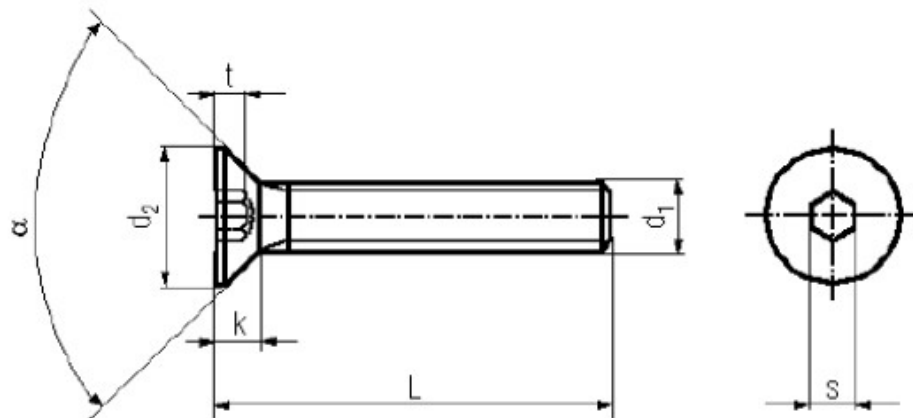

Material	Steel	Quality	010.9 / 10.9
Surface	black		

Article No. - 1480219

d ₁	M2
L	6
d ₂ max.	4
k max.	1,2
s	1,3
t	0,75
v	90

DIN 7991: Standard withdrawn

M2; M2,5 not according to DIN 7991.

As a result of the electro-plating process, fasteners in property classes ≥ 10.9 (>HRC 31) are susceptible to hydrogen embrittlement.

Limited use:

These screws should not be used for transmitting high axial forces. The hexagon socket is intended only for holding the screw to prevent rotation during tightening of the nut. If they are nevertheless tightened by means of the hexagon socket, the torques must be reduced because the key size is smaller and the depth of the hexagon socket is smaller. Property class 10.9. serves only for reducing the wear of the hexagon socket.

X-ON Electronics

Largest Supplier of Electrical and Electronic Components

Click to view similar products for [Screws & Fasteners](#) category:

Click to view products by [Bossard](#) manufacturer:

Other Similar products are found below :

[5721-1440-1/4-SS](#) [593503FX](#) [0098.0094](#) [0098.9206](#) [0098.9219](#) [0098.9221](#) [0098.9262](#) [596-2114-013](#) [59781-4](#) [59781-6](#) [0098.0026](#)
[0098.9210](#) [0098.9212](#) [60227-01](#) [60227-04](#) [60227-08](#) [60228-09](#) [618-00001](#) [62153-03](#) [62153-11](#) [M316-KSSTMCZ100](#) [M3440-SS](#) [M3442-SS](#) [M3448-SS](#) [6291A](#) [6292-1](#) [6-306105-9](#) [6-306131-4](#) [690432-1](#) [699161-000](#) [700989](#) [7-18023-1](#) [7-21002-8](#) [7230-3](#) [7235-3](#) [7248-1](#) [7248-2](#)
[73542-02](#) [CAPTIVE SHORT THUMBSCREW](#) [745564-1](#) [748174-2](#) [F03-02](#) [SUS316](#) [F1209](#) [751-00001](#) [80011](#) [809704-1](#) [8700](#) [8860220](#)
[9047](#) [95000002B](#) [9885-2](#)