

LOW JITTER PIN CONFIGURABLE DUAL LVPECL OUTPUT ULTRA MINIATURE PURE SILICON™ CLOCK OSCILLATOR

ASEMDLP

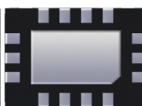

3.2 x 2.5 x 0.85 mm

ASEMDLP



RoHS/RoHS II compliant

Moisture Sensitivity Level – MSL 1

FEATURES:

- Ultra Miniature Pure Silicon™ Clock Oscillator
- Pin Configurable LVPECL Dual output
- Low Jitter (Period Jitter RMS 3ps typical)
- Low Integrated Phase Jitter 2ps max
- Excellent Shock & Vibration Immunity

APPLICATIONS:

- Consumer Electronics
- Storage Area Networks
- SATA, SAS, Fibre Channel
- Passive Optical Networks
- EPON, 10G-EPON, GPON, 10G-PON
- Ethernet
- 1G, 10GBASE-T/KR/LR/SR, and FCoE
- PCI Express

Low Jitter
Pin Configurable
LVPECL Dual Output
3G MEMS

STANDARD SPECIFICATIONS:

Pre-programmed Output Frequency Configuration

Ordering Info	Freq (MHz)	Freq Select Bits [FS2, FS1, FS0] – Default is [111]							
		000	001	010	011	100	101	110	111
Frequency Configuration 1	f _{OUT1}	106.25	100	125	156.25	156.25	156.25	125	400
	f _{OUT2}	25	100	125	156.25	25	125	25	200
Custom Configuration	f _{OUT1}	Contact Abracon for customized configurations							
	f _{OUT2}								

Frequency select bits [FS2, FS1, FS0] are weakly tied high so if left **floated**, the default setting will be [111] and the device will output the associated frequency highlighted in **Bold**. If other frequency combinations are required, please contact Abracon for customized configuration. Please see the configurable frequency range in the section 2.0

Key Electrical Specifications

Parameters	Minimum	Typical	Maximum	Units	Notes	
Configurable frequency range	10	----	460	MHz	Commercial, Industrial temp range	
Operating Temperature	-20	----	+70	°C	See options	
Storage Temperature	-55	----	+150	°C		
Overall Frequency Stability*1	-50	----	+50	ppm	See options	
Supply Voltage (V _{dd})	+2.25	----	+3.6	V		
Startup Time	----	----	5	ms		
Enable Time	----	----	20	ns		
Disable Time	----	----	5	ns		
Disable Current	----	21	23	mA		
Tri-state Function (Standby/Disable)	"1" (VIH≥0.75*V _{dd}) or Open: Oscillation "0" (VIL<0.25*V _{dd}) : Hi Z			V	40kΩ pull-up resistor embedded	
Aging	-5.0	----	+5.0	ppm	First year	
Supply Current (I _{dd})	----	89	----	mA	RL=50Ω, 156.25MHz	
Output Logic Level	V _{OH}	V _{dd} -1.08	----	V	RL=50 Ω	
	V _{OL}	----	V _{dd} -1.55			
Peak to Peak Output Swing	----	800	----	mV	Single-Ended	
Rise Time	T _r	----	250	ps	RL=50 Ω, CL=2pF 20% to 80%	
Fall Time	T _f	----	250	ps		
Duty Cycle		48	----	52	%	Differential

*1. Frequency stability includes frequency variations due to initial tolerance, temp. and power supply voltage

ABRACON IS
ISO9001:2008
CERTIFIED



ABRACON
CORPORATION

Visit www.abracon.com for Terms & Conditions of Sale **Revised: 11.05.14**
30332 Esperanza, Rancho Santa Margarita, California 92688
tel 949-546-8000 | fax 949-546-8001 | www.abracon.com

LOW JITTER PIN CONFIGURABLE DUAL LVPECL OUTPUT ULTRA MINIATURE PURE SILICON™ CLOCK OSCILLATOR

ASEMDLP

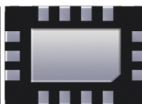

3.2 x 2.5 x 0.85 mm

ASEMDLP



RoHS/RoHS II compliant

Key Electrical Specifications (continued)

Parameters	Minimum	Typical	Maximum	Units	Notes
Period Jitter RMS (J_{PER})	-----	2.5	-----	ps	F01=F02= 156.25MHz
Integrated Phase Jitter (J_{PH})	-----	0.25	2	ps	200kHz ~ 20MHz, 156.25MHz
	-----	0.38	2		100kHz ~ 20MHz, 156.25MHz
	-----	1.70	2		12kHz ~ 20MHz, 156.25MHz

PHASE JITTER

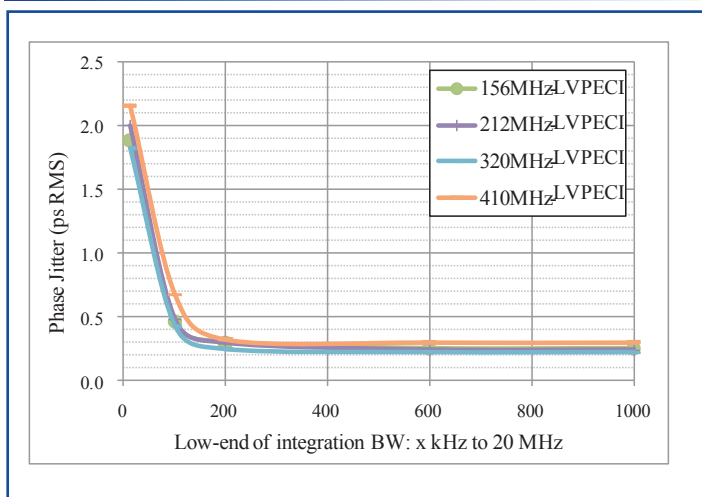

ABSOLUTE MAXIMUM RATINGS

Item	Minimum	Maximum	Unit	Condition
Supply Voltage	-0.3	+4.0	V	
Input Voltage	-0.3	$V_{dd}+0.3$	V	
Junction Temp.	-----	+150	°C	
Storage Temp.	-55	+150	°C	
Soldering Temp.	-----	+260	°C	40sec max
ESD			V	
HBM		4,000		
MM		400		
CDM		1,500		

OPTIONS AND PART IDENTIFICATION:

(left blank if standard)

ASEMDLP - - -

Operating Temp.
Blank: -20°C ~ +70°C
L: -40°C ~ +85°C

Overall Freq. Stability
Blank: ±50ppm
R: ±25 ppm

Packaging
Blank: Tube (110pcs / Tube)
T: Tape & Reel (1kpcs / reel)
T3: Tape & Reel (3kpcs / reel)
T5: Tape & Reel (5kpcs / reel)

Frequency Combination	Freq (MHz)	Freq Select Bits [FS2, FS1, FS0] – Default is [111]							
		000	001	010	011	100	101	110	111
Standard Configuration	f_{OUT1}	106.25	100	125	156.25	156.25	156.25	125	400
	f_{OUT2}	25	100	125	156.25	25	125	25	200
Custom Configuration	f_{OUT1}	Contact Abracon for customized configurations							
	f_{OUT2}								

Default condition: Frequency select bits [FS2, FS1, FS0] are all left floated. FS2, FS1, FS0 are pulled high [111]
Frequency combination and default frequency is customized upon request. Please contact Abracon for the frequency combinations.

ABRACON IS
ISO9001:2008
CERTIFIED



Visit www.abracon.com for Terms & Conditions of Sale **Revised: 11.05.14**
30332 Esperanza, Rancho Santa Margarita, California 92688
tel 949-546-8000 | fax 949-546-8001 | www.abracon.com

LOW JITTER PIN CONFIGURABLE DUAL LVPECL OUTPUT ULTRA MINIATURE PURE SILICON™ CLOCK OSCILLATOR

ASEMDLP

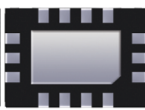

ASEMDLP



RoHS/RoHS II compliant

3.2 x 2.5 x 0.85 mm

MECHANICAL DIMENSIONS

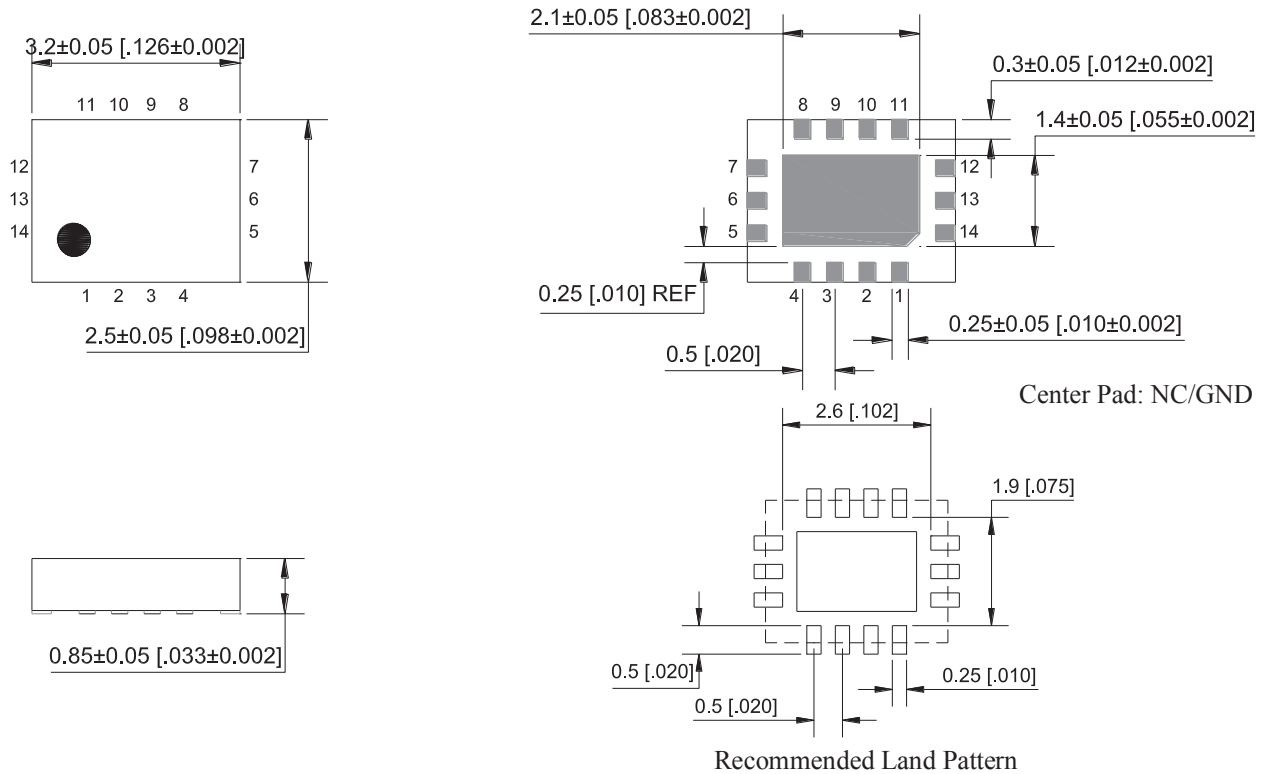

Pin No.	Pin Name	Pin Type	Description
1	Enable	I	Enables outputs when high and disables (tri-state) them when low
2	NC	NA	Leave unconnected or grounded
3	NC	NA	Leave unconnected or grounded
4	GND	Power	Ground
5	FS0	I	Least significant bit for frequency selection
6	FS1	I	Middle bit for frequency selection
7	FS2	I	Most significant bit for frequency selection
8	Output1+	O	Positive LVPECL Output 1
9	Output1-	O	Negative LVPECL Output 1
10	Output 2-	O	Negative LVPECL Output 2
11	Output 2+	O	Positive LVPECL Output 2
12	VDD2	Power	Power Supply 2 for LVPECL Output 2
13	VDD	Power	Power Supply
14	NC	NA	Leave unconnected or grounded

Dimensions: mm (inches)

LOW JITTER PIN CONFIGURABLE DUAL LVPECL OUTPUT ULTRA MINIATURE PURE SILICON™ CLOCK OSCILLATOR

ASEMDLP

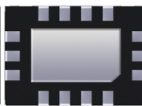

3.2 x 2.5 x 0.85 mm

ASEMDLP



RoHS/RoHS II compliant

REFLOW PROFILE

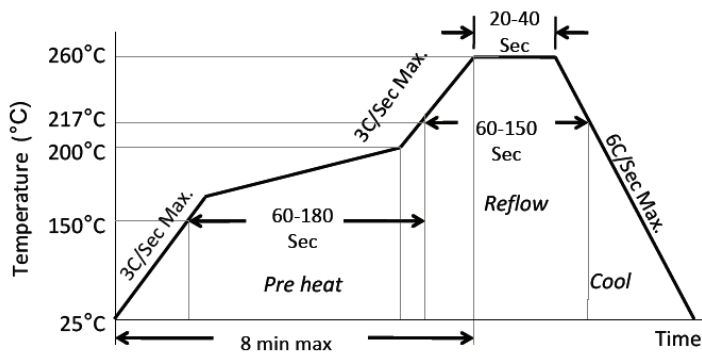

Ramp-Up Rate (200°C to Peak Temp)	3°C/Sec Max.
Preheat Time 150°C to 200°C	60-180 Sec
Time maintained above 217°C	60-150 Sec
Peak Temperature	255-260°C
Time within 5°C of actual Peak	20-40 Sec
Ramp-Down Rate	6°C/Sec Max.
Time 25°C to Peak Temperature	8 min Max.

TAPE & REEL:

T= 1,000pcs/reel (D=180mm)
T3= 3,000pcs/reel (D=180mm)
T5= 5,000pcs/reel (D=330mm)

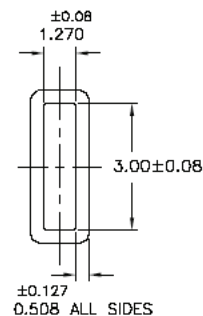
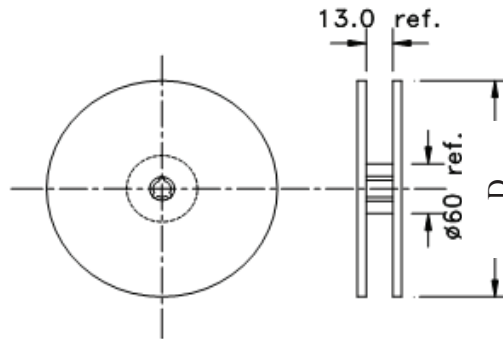
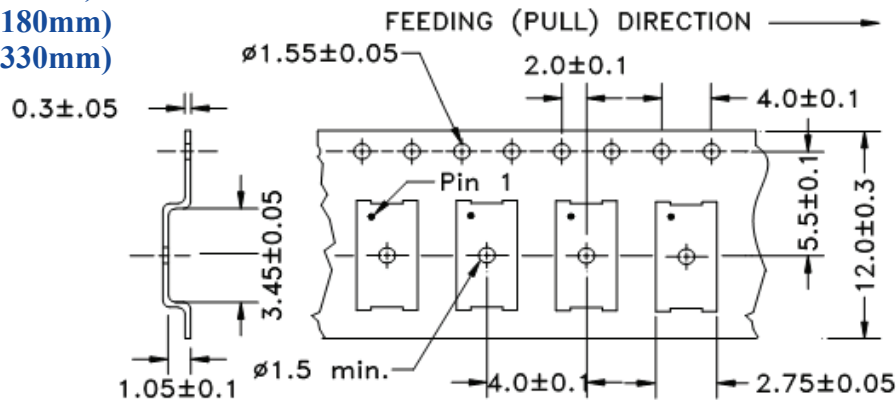

Tube: 110 pcs/tube

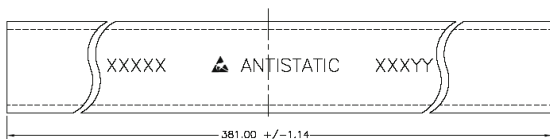

Unit orientation in tube:



Dimensions: mm

ATTENTION: Abracon Corporation's products are COTS – Commercial-Off-The-Shelf products; suitable for Commercial, Industrial and, where designated, Automotive Applications. Abracon's products are not specifically designed for Military, Aviation, Aerospace, Life-dependant Medical applications or any application requiring high reliability where component failure could result in loss of life and/or property. For applications requiring high reliability and/or presenting an extreme operating environment, written consent and authorization from Abracon Corporation is required. Please contact Abracon Corporation for more information.

ABRACON IS
ISO9001:2008
CERTIFIED



Visit www.abracon.com for Terms & Conditions of Sale **Revised: 11.05.14**
30332 Esperanza, Rancho Santa Margarita, California 92688
tel 949-546-8000 | fax 949-546-8001 | www.abracon.com

X-ON Electronics

Largest Supplier of Electrical and Electronic Components

Click to view similar products for [MEMS Microphones](#) category:

Click to view products by [ABRACON](#) manufacturer:

Other Similar products are found below :

[8103AC8333S25.00000X](#) [SPK0838HT4H-1](#) [MMICT4076-00-908](#) [MMICT4078-00-908](#) [MMICT3902-00-012](#) [1007079-1](#) [TA-35.328MBD-T](#)
[TC-106.250MBD-T](#) [TD-22.5792MCD-T](#) [ASFLM1-25.000MHZ-C](#) [5000AC-8E-25E0-25.000000X](#) [3807ACTC3-33EG-8.19200](#)
[501AAA27M0000CAF](#) [TC-133.330MBD-T](#) [TC-38.400MBD-T](#) [TD-6.000MCD-T](#) [XX7V1A1PAM12](#) [9120AI-2C3-25E100.0000](#)
[MP34DB01TR](#) [8002AI-13-33E16.00000](#) [5001AI-2D-18N0-20.000000](#) [UC2000-30GM-IUR2-V15](#) [MM034202-1](#) [INMP621ACEZ-R7](#) [ICS-](#)
[41350](#) [ICS-43432](#) [ICS-40181](#) [ICS-40300](#) [ICS-40619](#) [ICS-40310](#) [MM042602-4](#) [PMM-3738-VM1010-R](#) [MP34DT06JTR](#) [ICS-52000](#)
[SPW0442HR5H-1](#) [MM042602-5](#) [INMP504ACEZ-R7](#) [ICS-40720](#) [INMP510ACEZ-R7](#) [MM033802-1](#) [ICS-43434](#) [ICS-40618](#)
[INMP521ACEZ-R7](#) [ICS-40180](#) [ASDM4-12.000MHZ-LC-T](#) [ASFLM2-28.224MHZ-LR-T](#) [9003AC-14-33EQ25.00000](#) [1618AA-13-33S-](#)
[16.000000G](#) [SPQ0410HE5H-PB](#) [PMM-3738-VM1000-R](#)