

DTSM(G)-6(2) SERIES

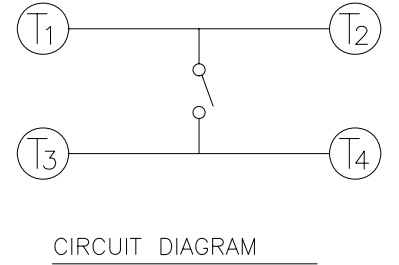

**DIMENSIONS**

**DTSM-6**

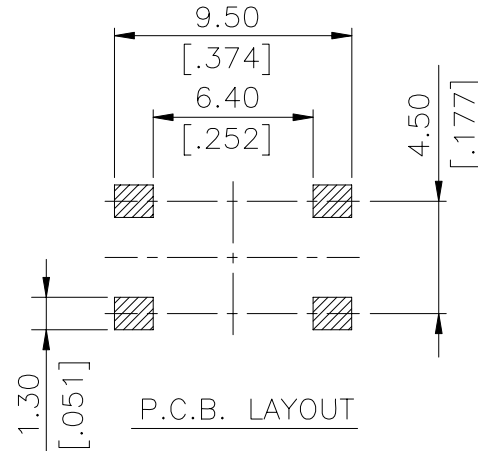
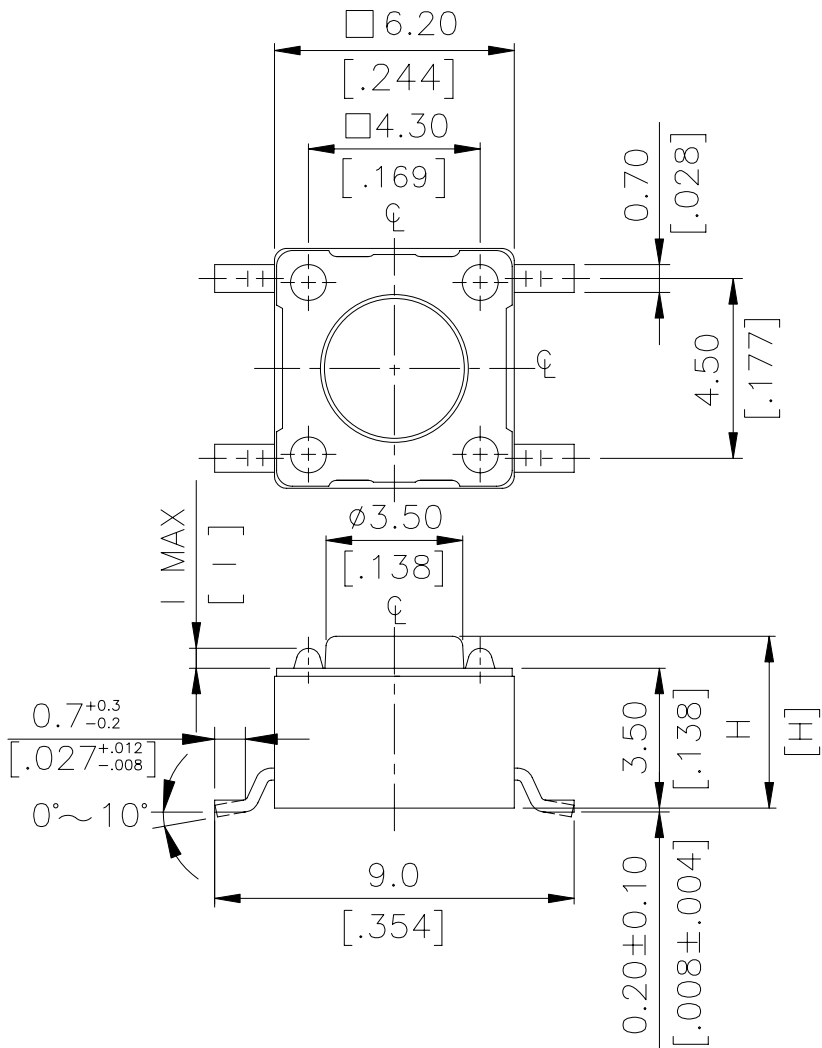

DTSM-62~66 □ -V	0.6 MAX	.0236MAX
DTSM-61 □ -V	0.5 MAX	.0197MAX
PROD. NO.	I	INCHES.

DTSM-66 □ -V	13.0 [.512]
DTSM-65 □ -V	9.5 [.374]
DTSM-63 □ -V	7.0 [.275]
DTSM-62 □ -V	5.0 [.197]
DTSM-61 □ -V	4.3 [.169]
PROD. NO.	H

General Tolerance : ±0.2mm

**DTSM-64 □**

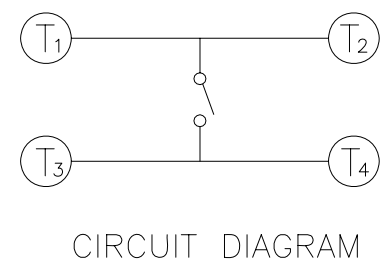
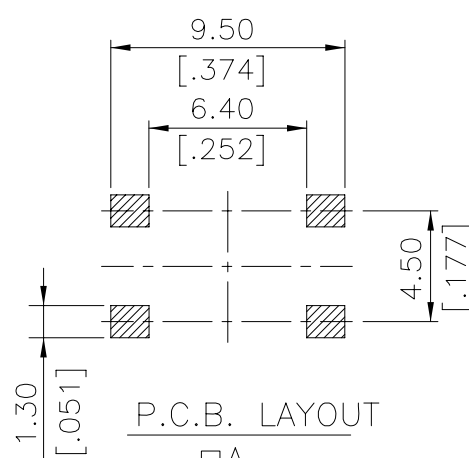
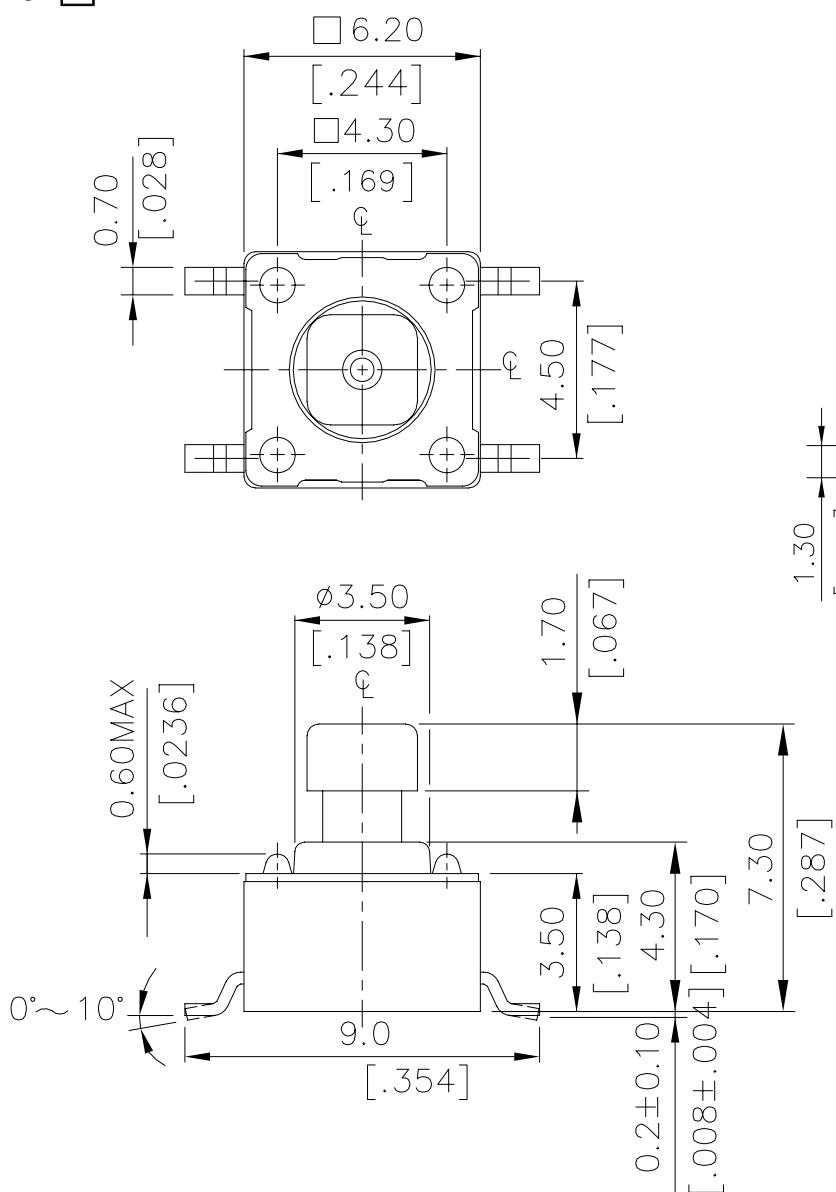

DTSM-644 □ -V	□A	2.4	[.095]
	□B	1.6	[.063]
DTSM-648 □ -V	□A	2.8	[.110]
	□B	2.0	[.079]
PROD. NO.	LOC.	MM.	INCH.

DIMENSION

General Tolerance : ±0.2mm

# DTSMG-6

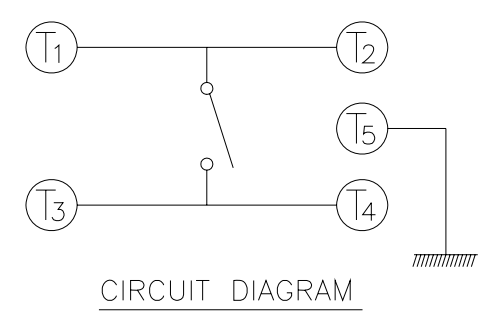
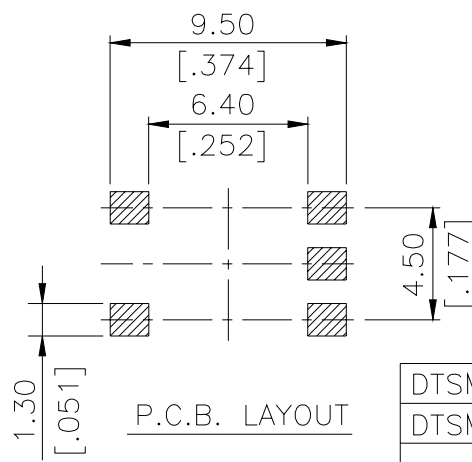
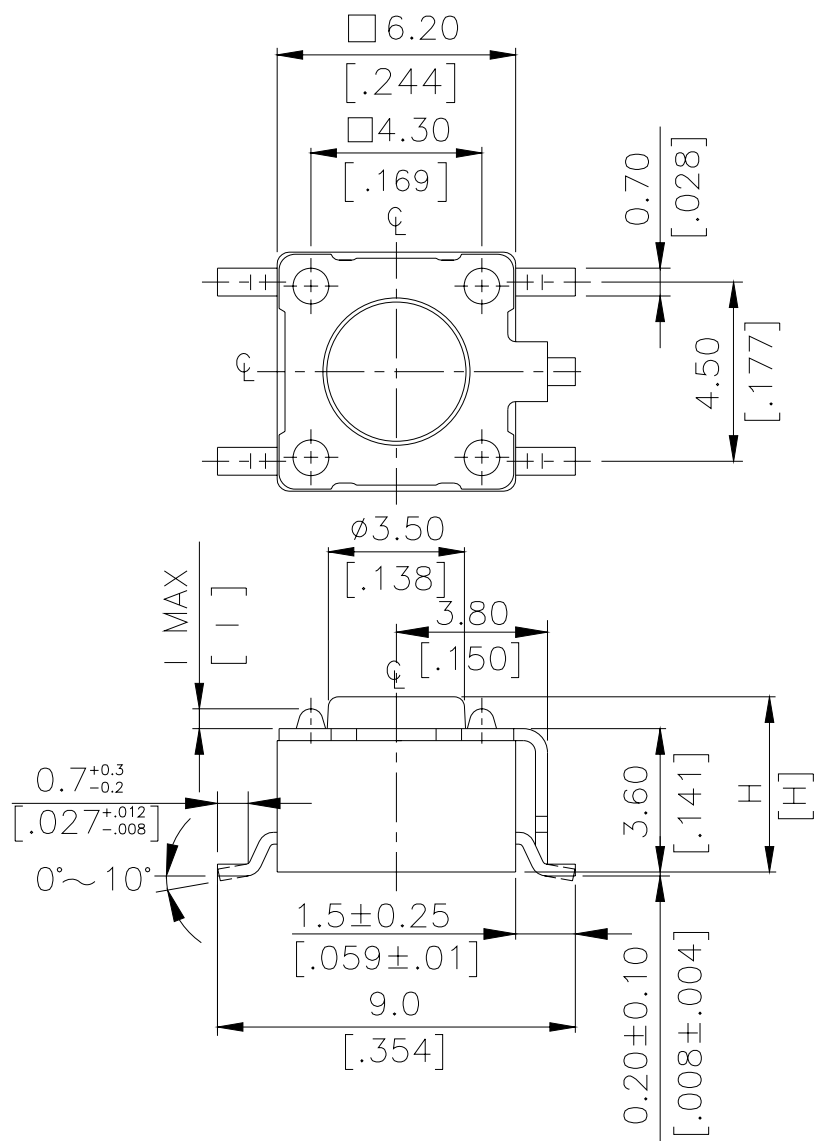

DTSMG-62~66□-V	0.5 MAX	.02MAX
DTSMG-61□-V	0.4 MAX	.016MAX
PROD. NO.	I	INCHES.

DTSMG- 6 6□ -V	13.0 [0.512]
DTSMG- 6 5□ -V	9.5 [0.374]
DTSMG- 6 3□ -V	7.0 [0.275]
DTSMG- 6 2□ -V	5.0 [0.197]
DTSMG- 6 1□ -V	4.3 [0.169]
PROD. NO.	H

General Tolerance : ±0.2mm

# DTSM-2

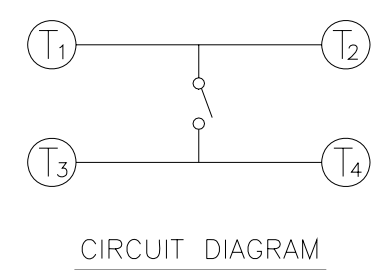
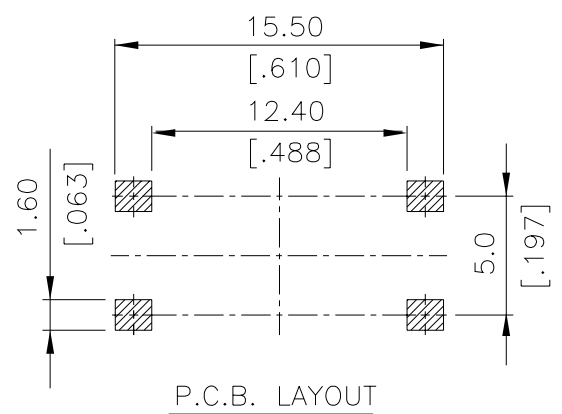
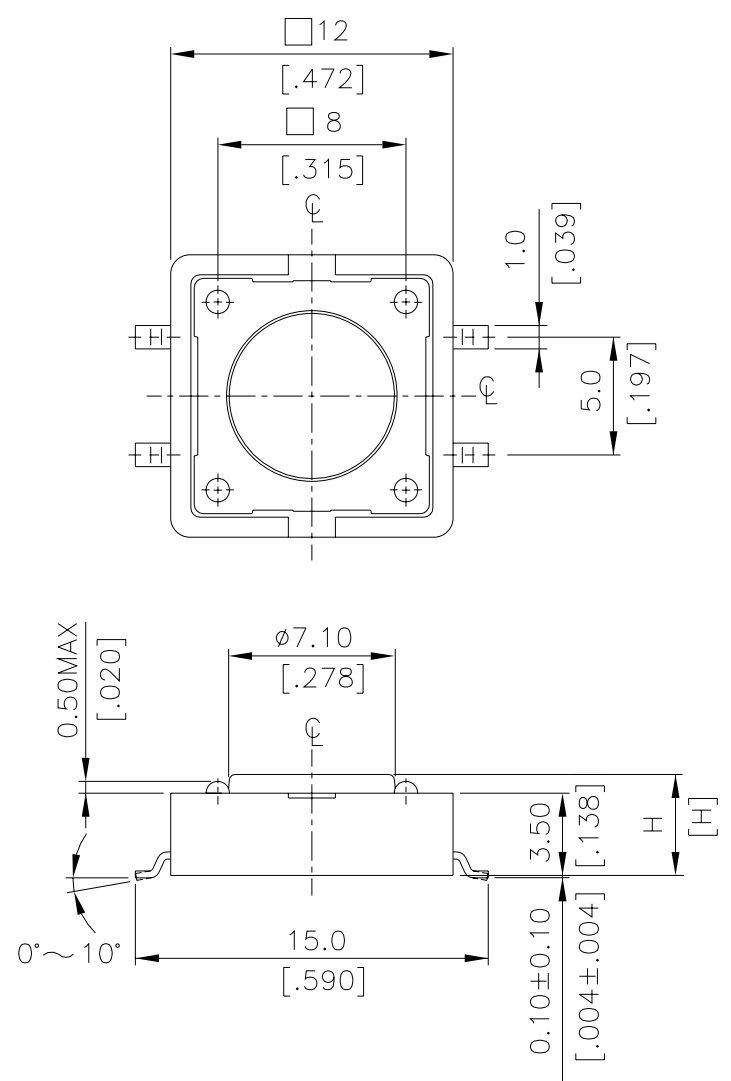

DTSM-25	8.5[0.335]
DTSM-21	4.3[0.169]
PART NO	H

General Tolerance : ±0.2mm

**DTSM-24**

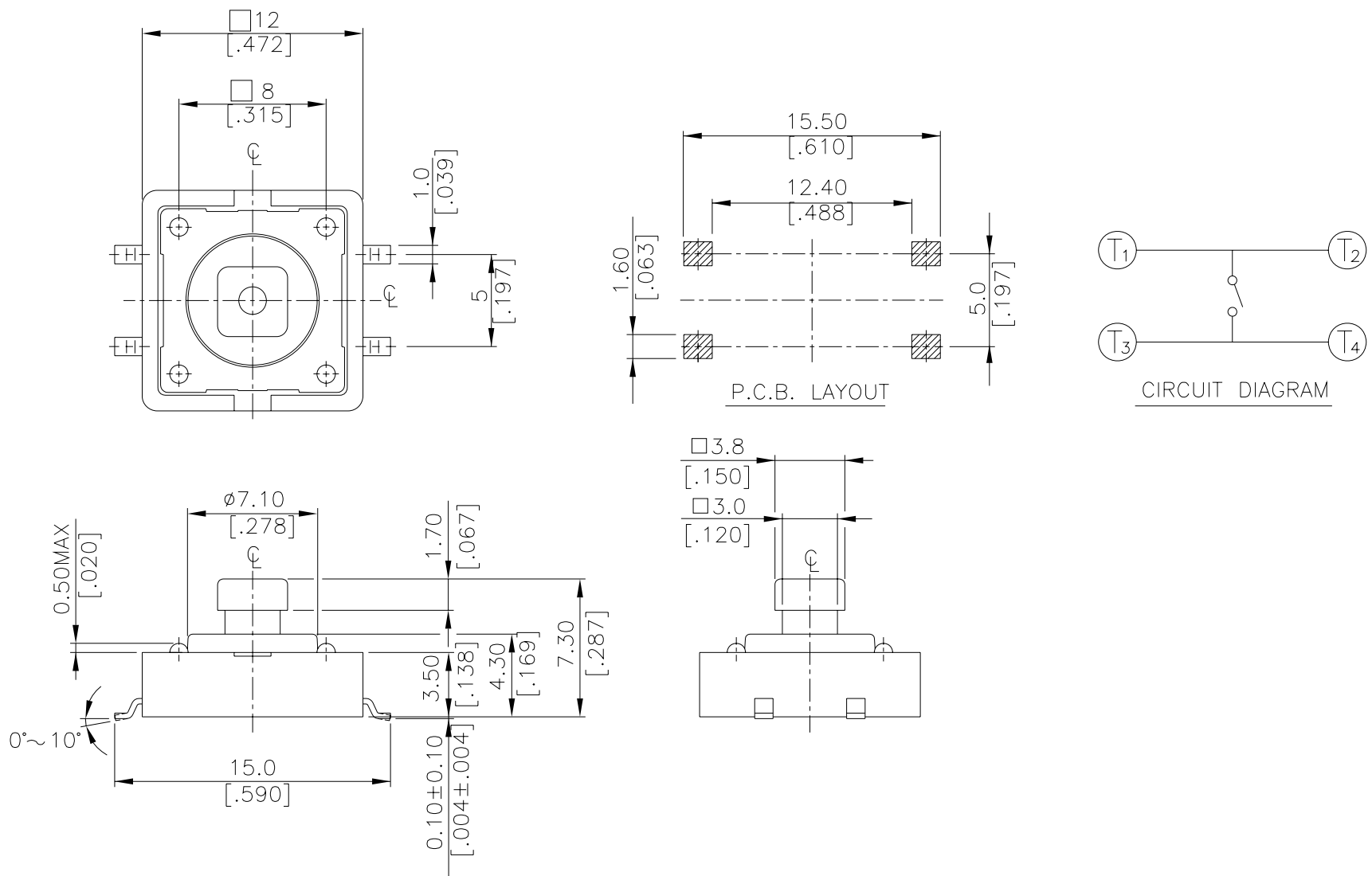

General Tolerance :  $\pm 0.2\text{mm}$

**DTSJ-6**

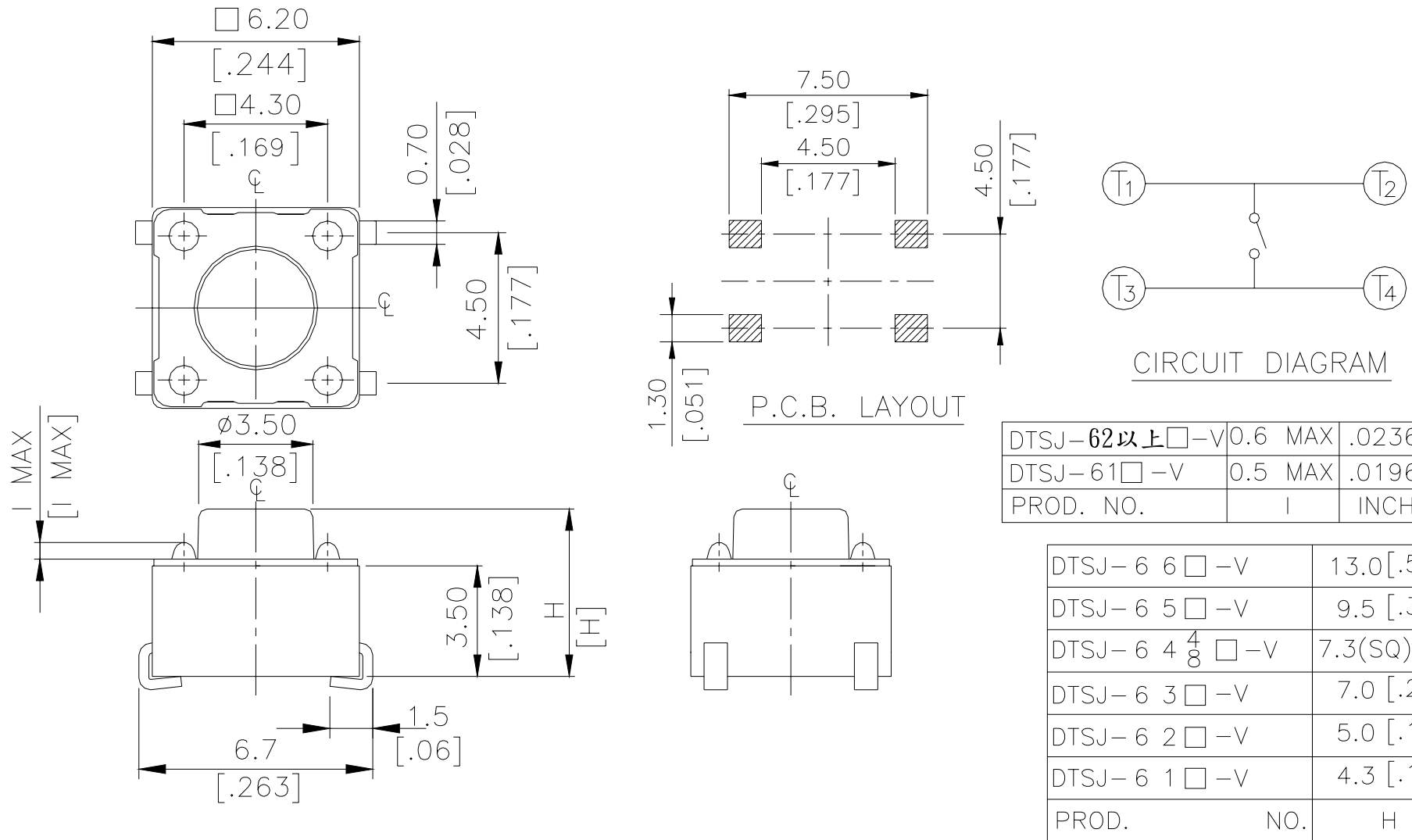

DTSJ-62以上□-V	0.6 MAX	.0236 MAX
DTSJ-61□-V	0.5 MAX	.0196 MAX
PROD. NO.	I	INCHES

DTSJ-6 6□-V	13.0 [.512]
DTSJ-6 5□-V	9.5 [.374]
DTSJ-6 4 $\frac{4}{8}$ □-V	7.3(SQ)[.287]
DTSJ-6 3□-V	7.0 [.275]
DTSJ-6 2□-V	5.0 [.197]
DTSJ-6 1□-V	4.3 [.169]
PROD.	NO. H

# HOW TO ORDER

D T S   -     -  -

Package style :

B=Tube

T/R=Tape&Reel <▲ Except DTSM-66>

Soldering :

V=Lead Free Solderable

Q=Halogen Free

=Phosphor Bronze Dome

S= Stainless Steel Dome

Color Of Stem For Operating Force :

K=Black,100gf

N=Brown,160gf

R=Red,260gf

S=Salmon,320gf

Y=Yellow,520gf

Dimension H :

1=4.3mm

2=5.0mm

3=7.0mm

44=7.3mm(SQ)X2.4mm

48=7.3mm(SQ)X2.8mm

5=9.5mm

6=13mm

Prod Size :

6=6X6mm

=Without Ground Terminal

G=With Ground Terminal

M=Surface-Mourting Type Tactile Switch

J= Surface-Mourting Type Tactile Switch

DTSM - □ □ □ - □ - □ - □

Package Style :  
B = Tube  
T/R = Tape & Reel

Soldering :  
V = Lead Free Solderable  
Q = Halogen Free  
□ = Phosphor Bronze Dome  
(\*S = Stainless Steel Dome)  
(\*12X12 K、S、Y Unavailable)

Color Of Stem For Operating Force :  
N = Brown, 160gf  
R = Red, 260gf  
S = Salmon, 320gf

Dimension H :  
1 = 4.3mm  
4 = 7.3mm(SQ)X3.8mm  
5 = 8.5mm

Prod. Size :  
2 = 12X12mm

Surface-Mounting Type Tactile Switch  
<Non-Washable>

## SPECIFICATION

### △MECHANICAL

Operation Force: 520 ± 130gf Yellow (Y)  
320 ± 80gf Salmon (S)  
260 ± 50gf Red (R)  
160 ± 50gf Brown (N)  
100 ± 50gf Black (K)

Stroke: (6x6) 0.25 +0.2mm / -0.1mm  
(12X12) 0.35 ±0.1mm

Operation Temperature: -25°C to +70°C

Storage Temperature: -30°C to +80°C

### △ELECTRICAL(6x6mm) (Phosphor Bronze dome)

Electrical Life: 200,000 cycles for 100,160gf  
100,000 cycles for 260gf  
50,000 cycles for 320,520gf

(Stainless Steel dome)

Electrical Life: 1,000,000 cycles for 100,160gf  
500,000 cycles for 260gf  
300,000 cycles for 320、520gf

(Phosphor bronze dome)

### ELECTRICAL (12X12mm)

Electrical Life: 100,000 cycles for 320gf  
100,000 cycles for 260gf  
200,000 cycles for 160gf

(Stainless Steel dome)

Electrical Life: 500,000 cycles for 260gf  
1,000,000 cycles for 160gf

Rating: 50mA, 12VDC

Contact Resistance: 100mΩ max.

Insulation Resistance: 100MΩ min. at 500VDC

Dielectric Strength: 250VAC/ minute

Contact Arrangement: SPST

## MATERIAL

△COVER: Stainless Steel(for DTSM-6、2)  
Nickel Silver (for DTSMG-6)

△BASE: UL94V-0 Nylon High-Temp. Thermoplastic  
Color: Black (Standard)  
Color: Brown (V option)

△STEM: UL94V-0 Nylon High-Temp. Thermoplastic  
Color: Black (100gf), Brown (160gf)  
Red (260gf), Salmon (320gf)  
Yellow (520gf)

△CONTACT DISC: Phosphor Bronze with silver cladding  
(Standard)  
Stainless Steel(V option)

△TERMINAL: Brass with silver plated

# SOLDERING PROCESS

△ **HAND SOLDERING** : Use a soldering iron of 30 watts, controlled at 350°C approximately 5 seconds while applying solder.

△ **REFLOW SOLDERING** : When applying reflow soldering, the peak temperature or the reflow oven should be set to 260°C max.

△ **Temperature Profile:**

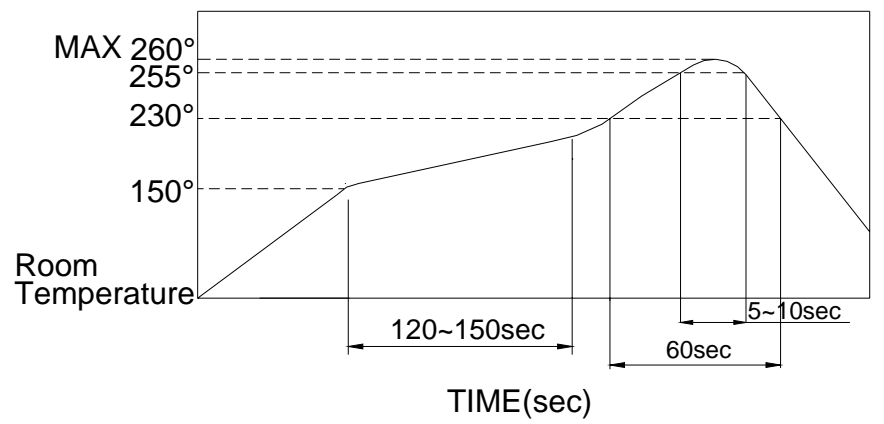

# PACKING

Part Number	Number Per Tube	Number Per Reel
DTSM-61	77	1000
DTSMG-61	-	1000
DTSM-62	77	900
DTSMG-62	-	1000
DTSM-63	77	700
DTSMG-63	-	500
DTSM-644(8)	77	500
DTSMG-644(8)	-	500
DTSM-65	77	380
DTSMG-65	-	380
DTSM-66	77	-
DTS(M)-21	40	700
DTS(M)-24	40	500
DTS(M)-25	40	400

# DTSM-2 REEL

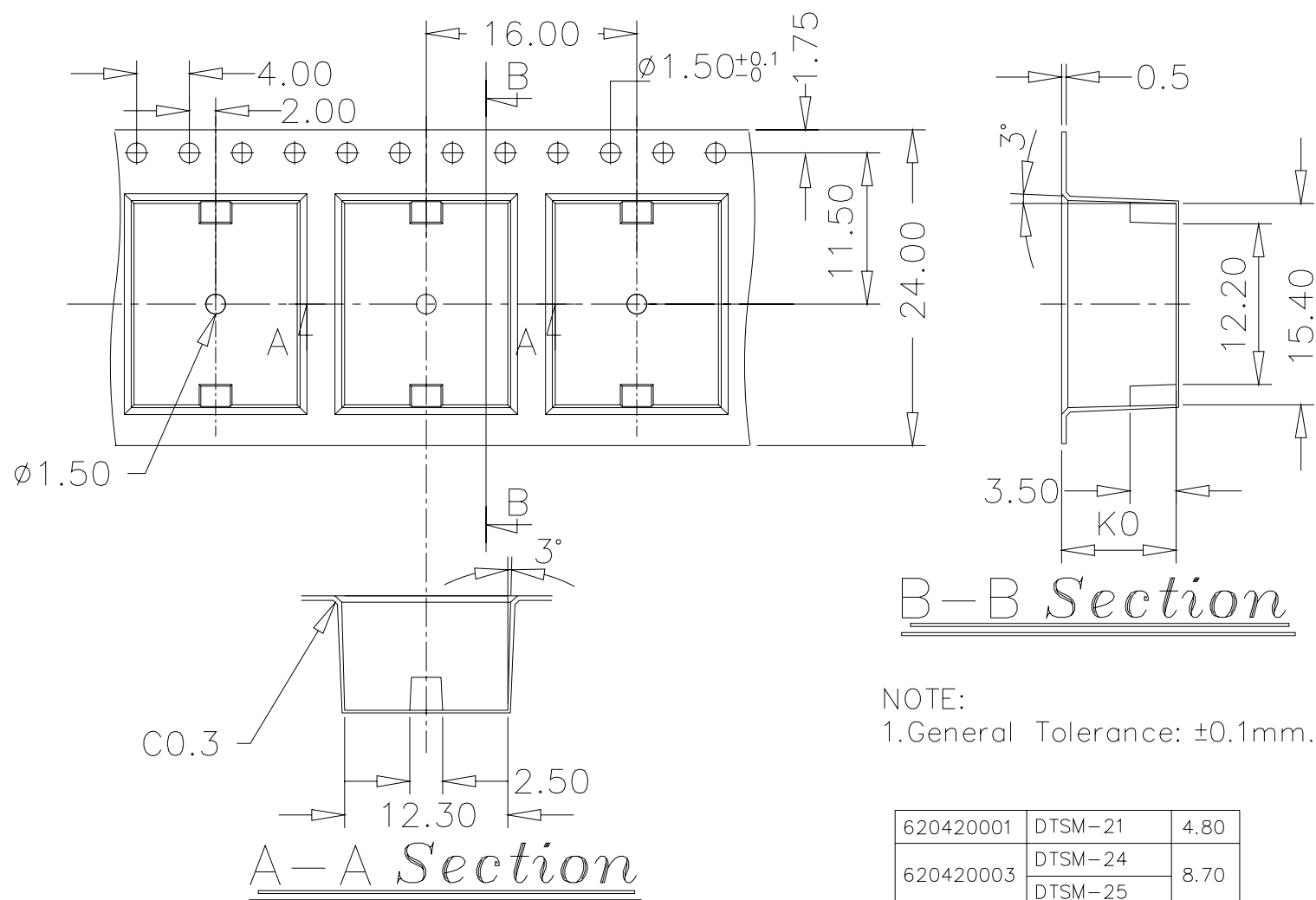

NOTE:  
1. General Tolerance: ±0.1mm.

620420001	DTSM-21	4.80
620420003	DTSM-24	8.70
	DTSM-25	
PART NO:	PART NAME:	KO

General Tolerance : ±0.1mm

**DTSM-61.62 REEL**

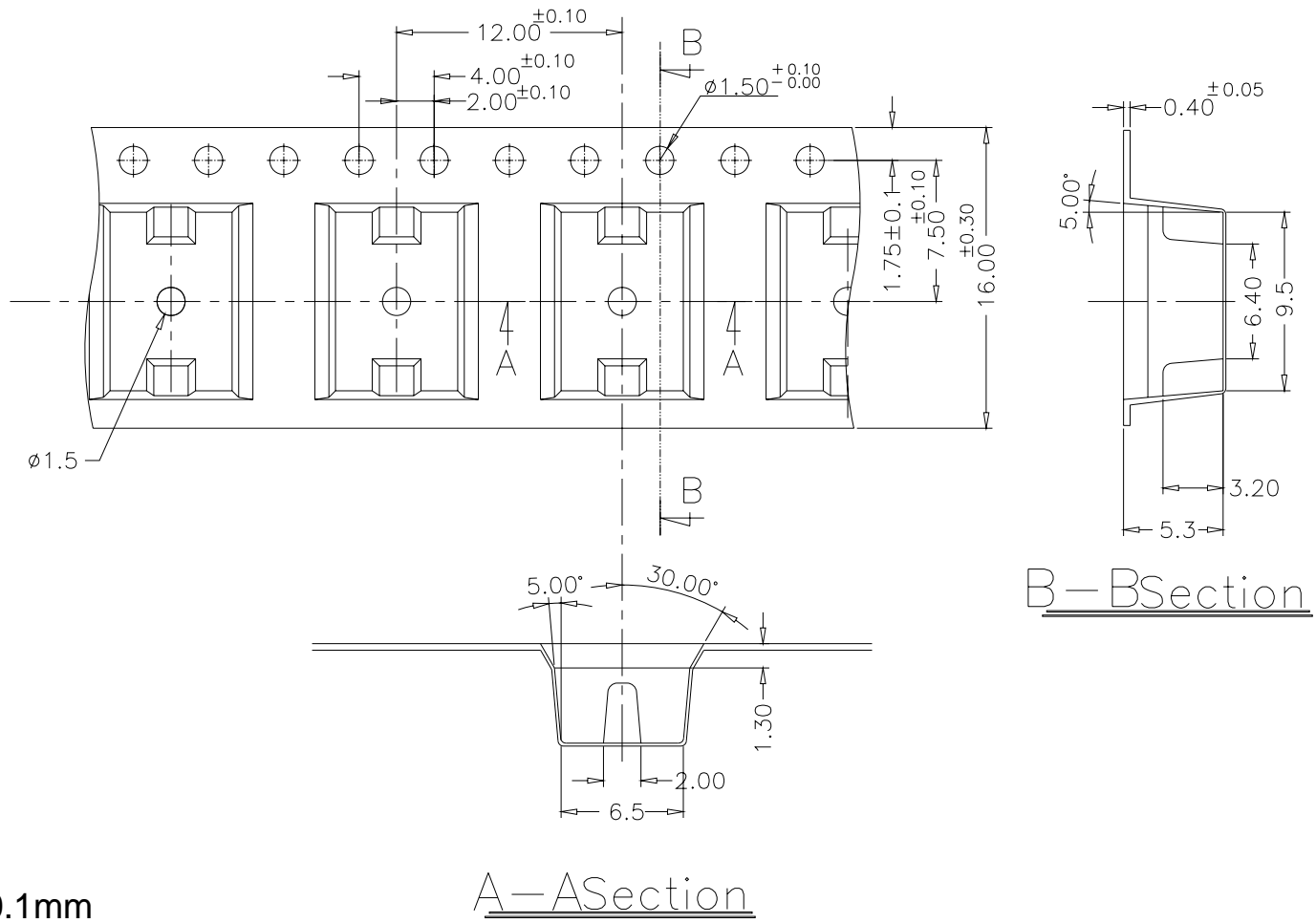

General Tolerance :  $\pm 0.1\text{mm}$

A-A Section

B-B Section

**DTSM-64 REEL**

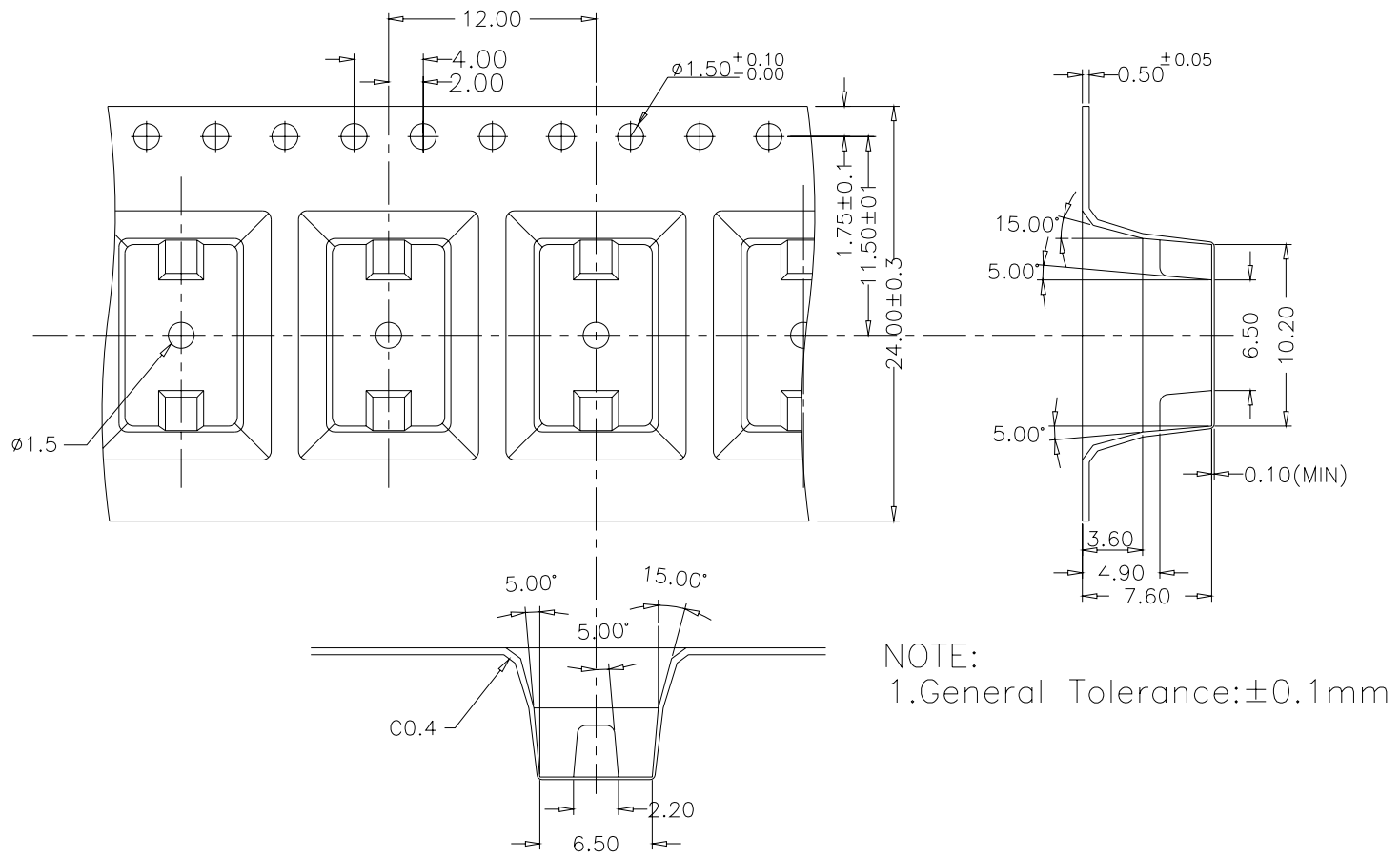

**DTSM-65 REEL**

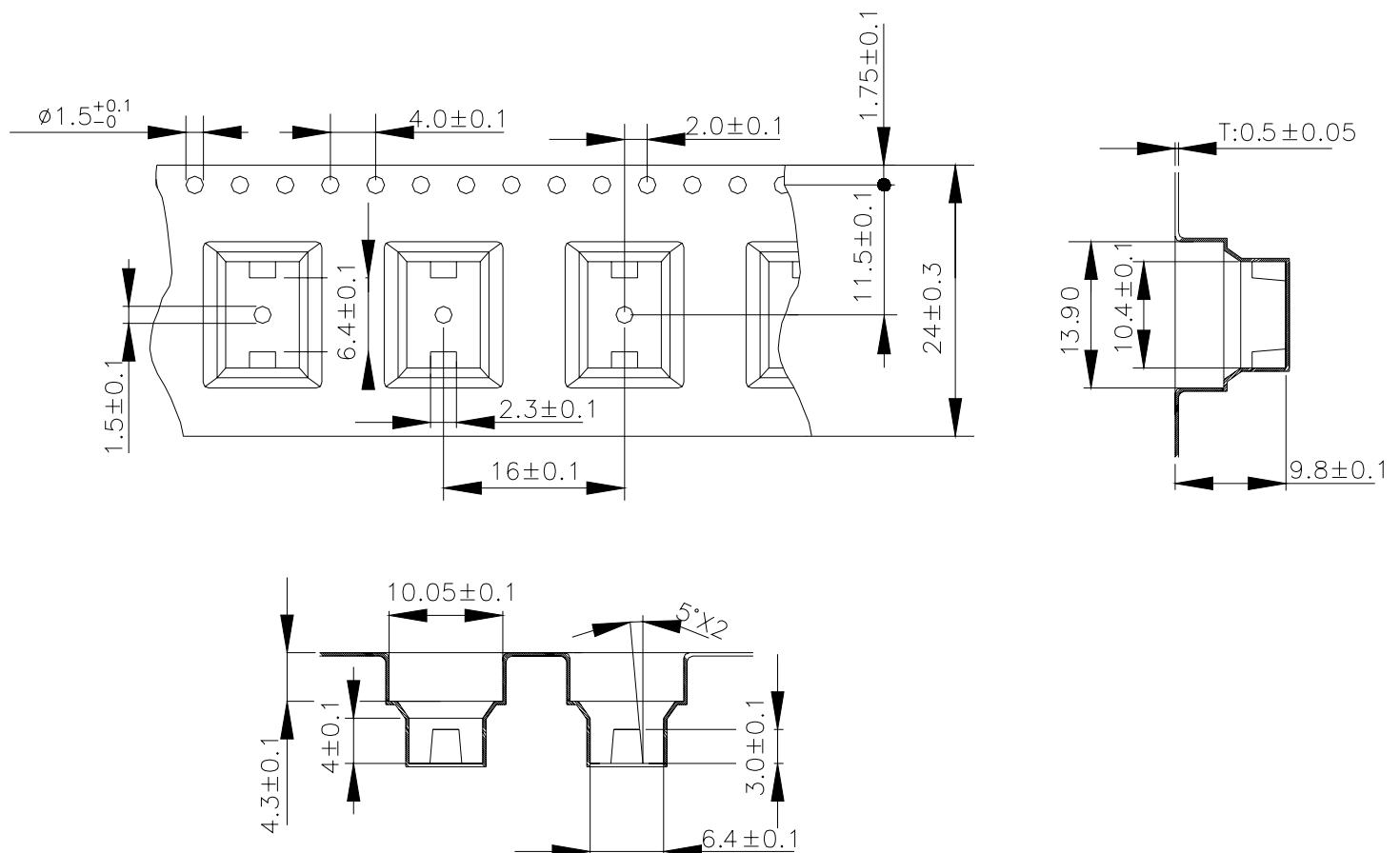

General Tolerance :  $\pm 0.1\text{mm}$

**DTSMG-61.62.63.64.65 REEL**

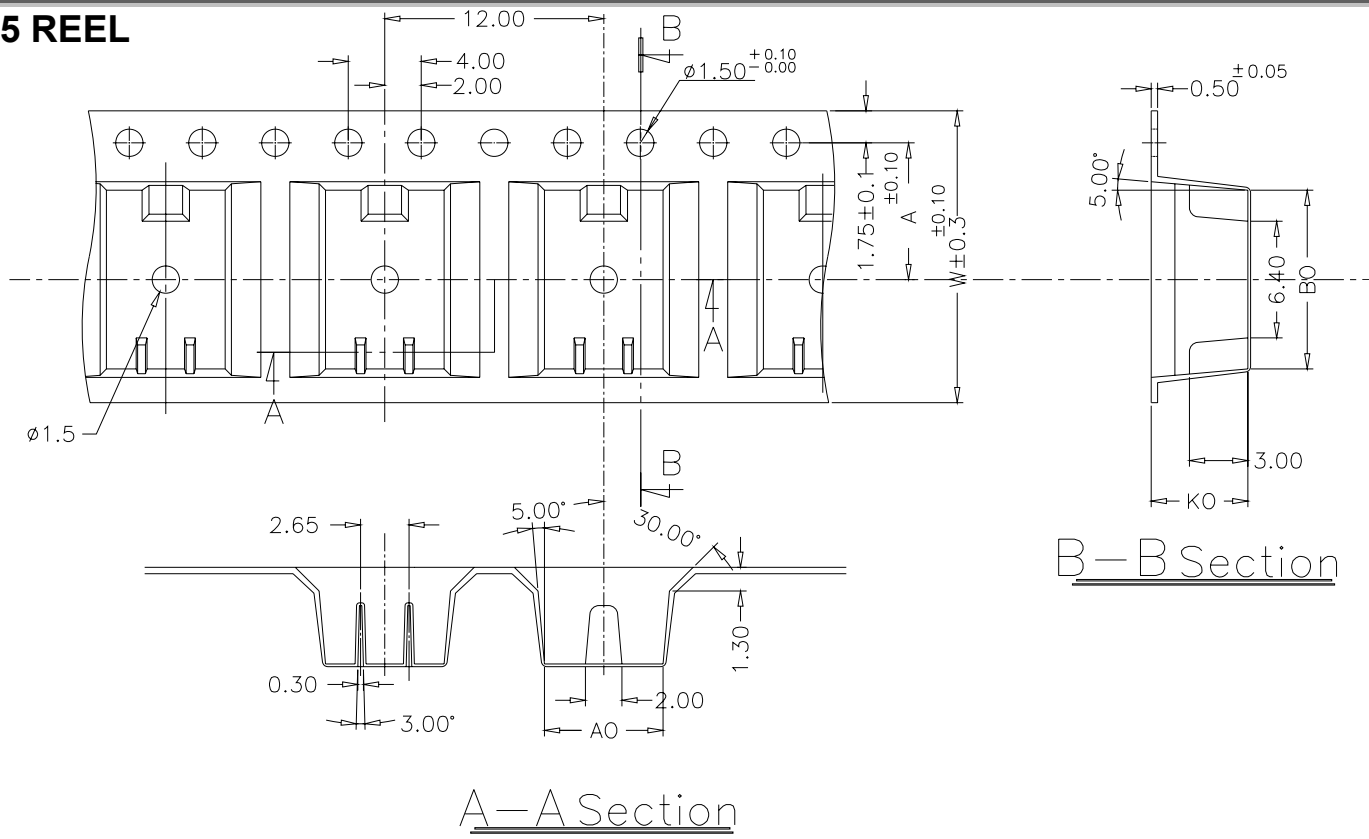

DTSMG-65	6.50	9.50	9.75	24.0	11.50
DTSMG-63.64	6.50	9.50	7.40	24.0	
DTSMG-61.62	6.50	9.50	5.30	16.0	7.50
PART NAME:	A0	B0	K0	W	A

General Tolerance : ±0.1mm

**DTSM-61.62 TUBE**

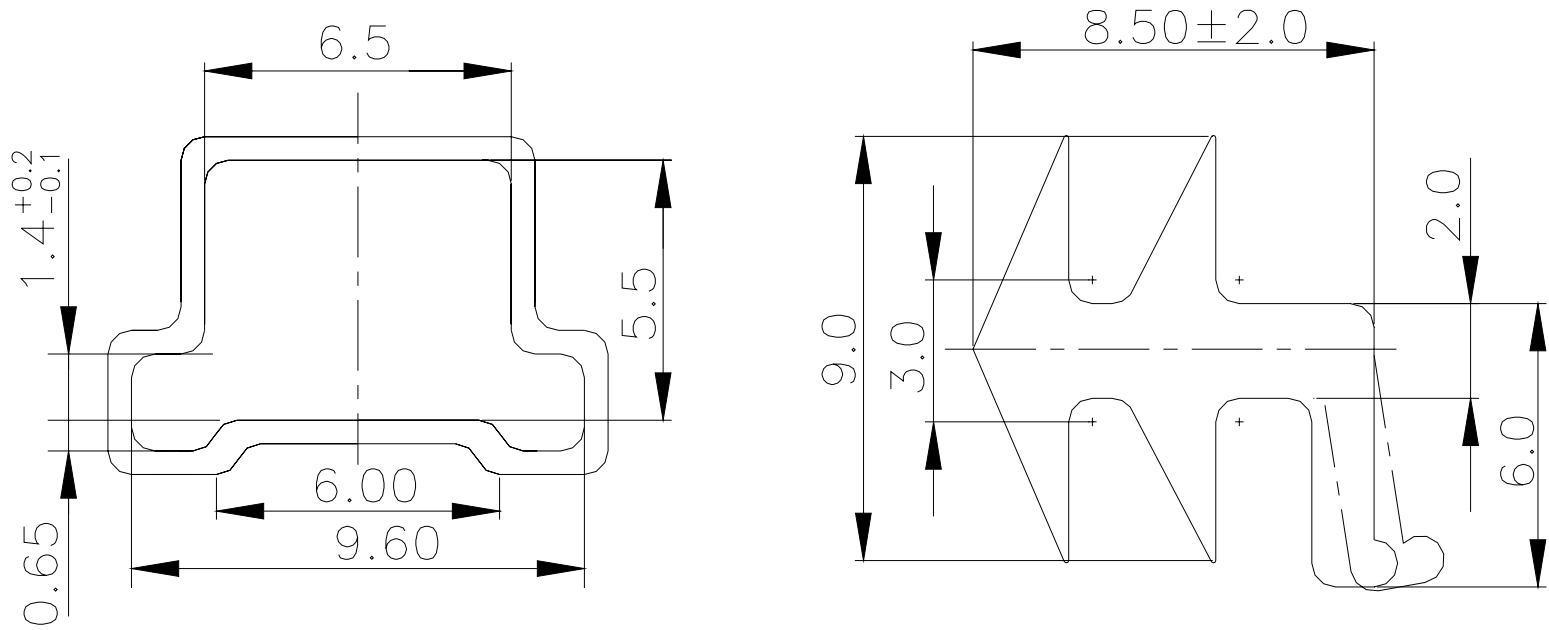

General Tolerance : ±0.2mm

**DTSM-63.644(8) TUBE**

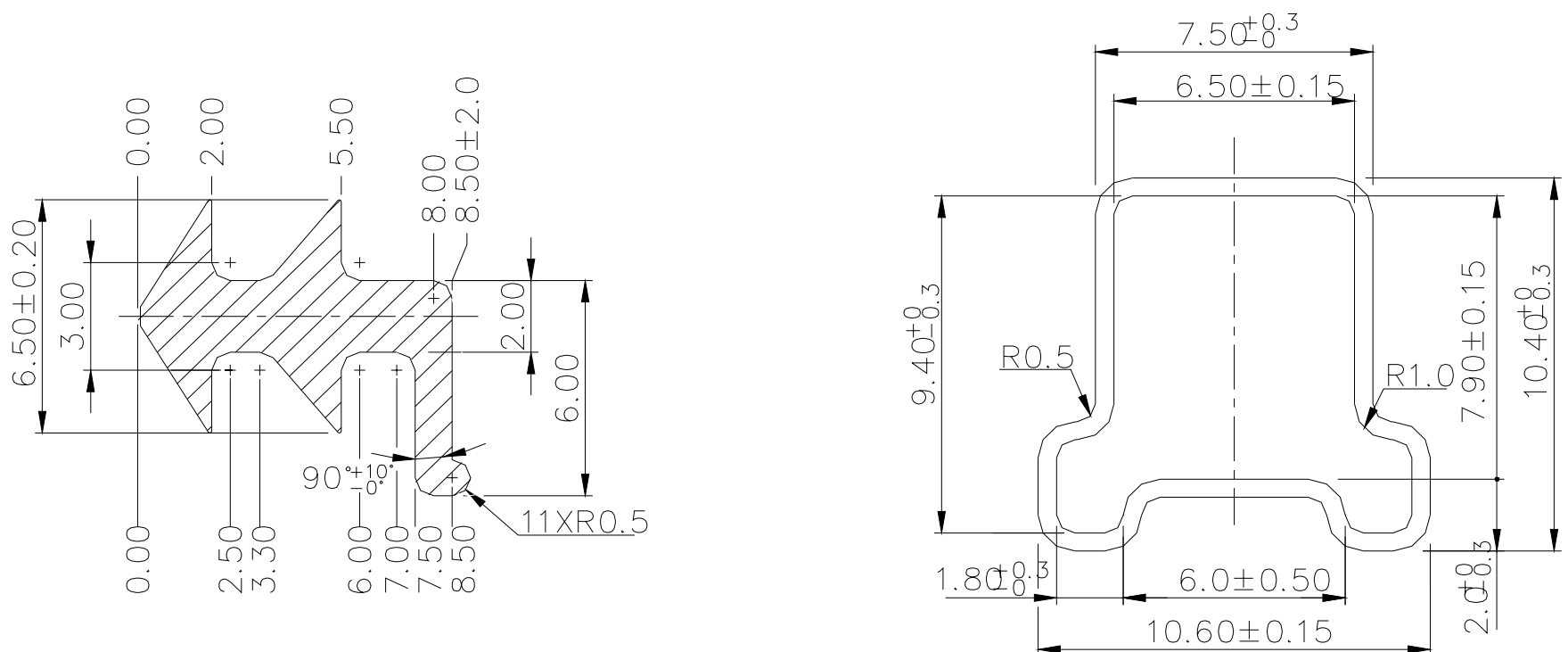

General Tolerance : ±0.2mm



**DTSM-65.66 TUBE**

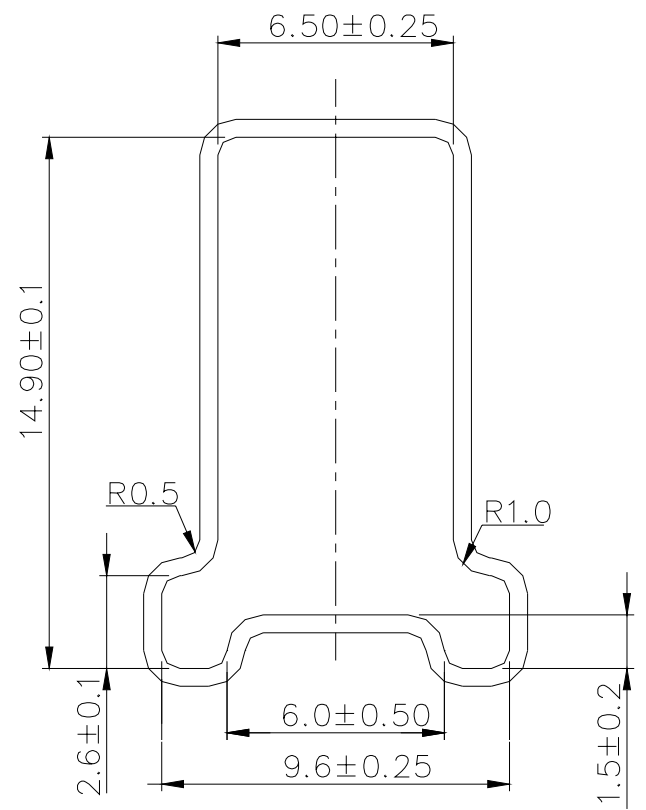
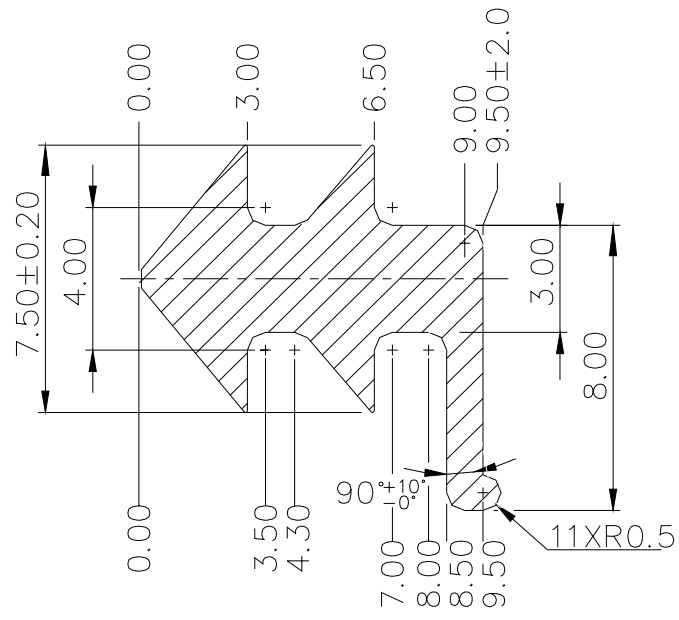

General Tolerance : ±0.2mm

**DTSM-2 TUBE**

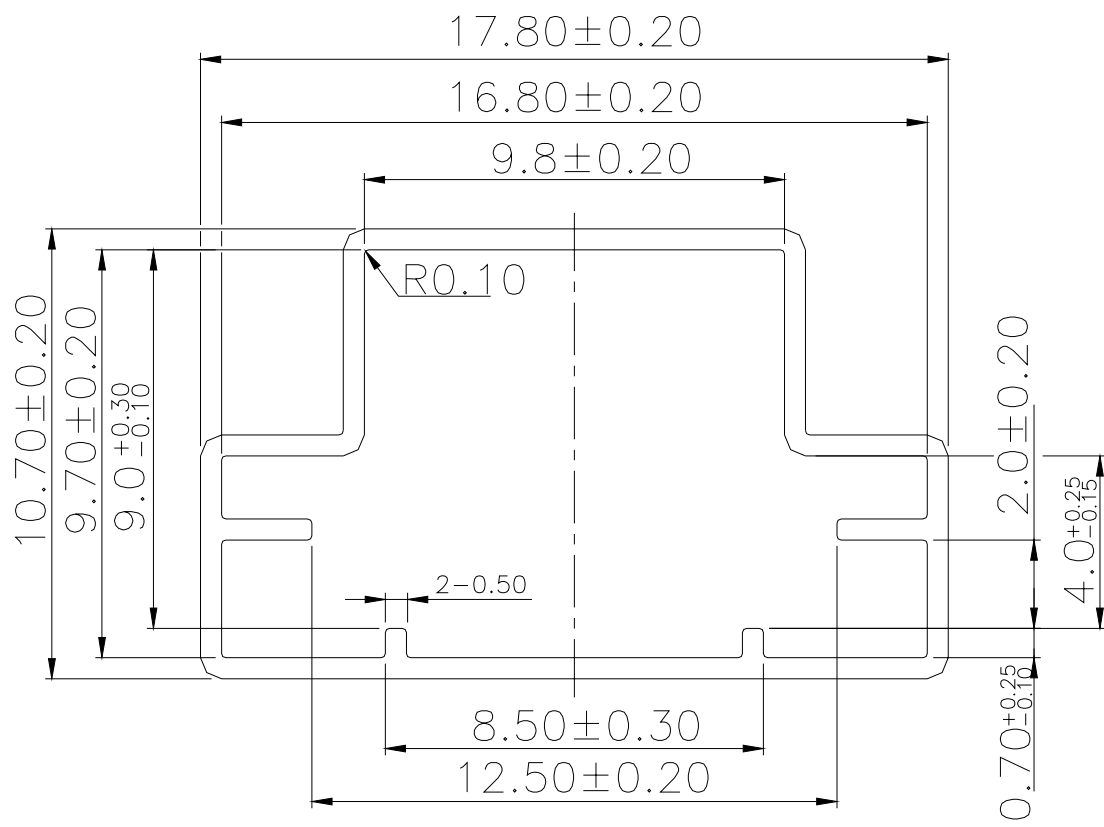

General Tolerance : ±0.2mm

**DTS-2 TUBE**

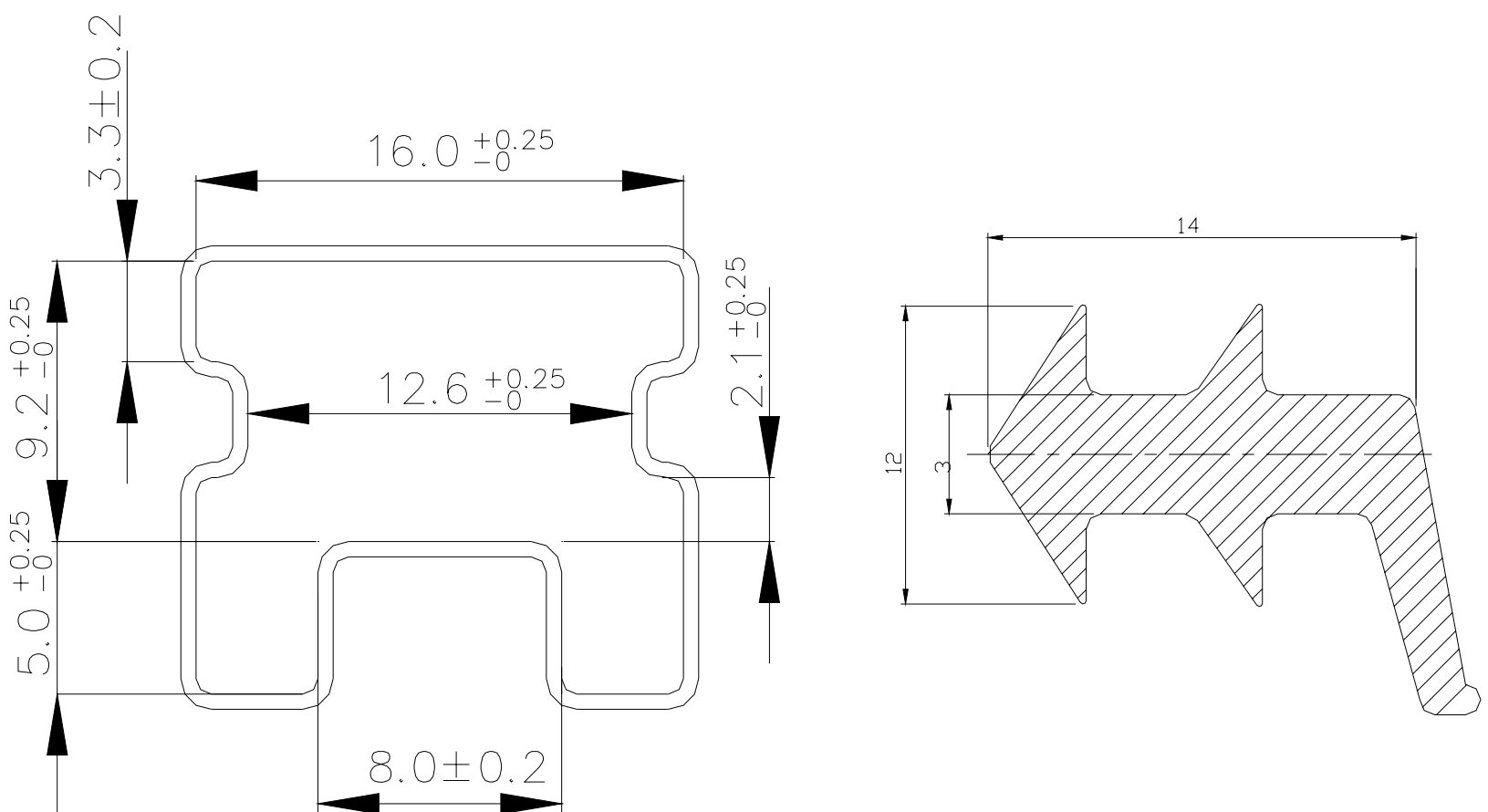

General Tolerance : ±0.2mm

## X-ON Electronics

Largest Supplier of Electrical and Electronic Components

*Click to view similar products for [Tactile Switches](#) category:*

*Click to view products by [Diptronics](#) manufacturer:*

Other Similar products are found below :

[KMR633NG LFG](#) [5GTH92001](#) [5GTH9202242](#) [6426-201-11343](#) [MJ1226](#) [MJTP1109B](#) [MJTP1138EAUTR](#) [MJTP1230BL](#) [MJTPSHW](#)  
[GS6.90F300QP](#) [1-1977223-0](#) [1-1977120-4](#) [ADTSA62NV](#) [ADTSA62RV](#) [ADTSA63KV](#) [ADTSA644NV](#) [ADTSM24NVTR](#) [ADTSMW66NV](#)  
[ADTSMW67RV](#) [ATM533VTR](#) [1571300-3](#) [B3F-3123](#) [B3F-6055A](#) [B3F-B32-01-KIT](#) [1977177-8](#) [1977266-1](#) [2-1977223-4](#) [2-1977223-7](#)  
[ADTS644KV](#) [ADTSA61RV](#) [ADTSA62KV](#) [ADTSA63NV](#) [ADTSA63RV](#) [ADTSA65NV](#) [ADTSM21NSVTR](#) [ADTSM25RVTR](#)  
[ADTSM31RVTR](#) [ADTSM32NVTR](#) [ADTSM61YVTR](#) [ADTSM63SVTR](#) [ADTSM644KVTR](#) [ADTSMW64RV](#) [ADTSMW69NV](#)  
[FSMRA4JHA04](#) [GS4.70F300QP](#) [D38999/20JJ37SA](#) [TL1105B](#) [TL1105J](#) [ATH447K2Q](#) [ATM534VTR](#)