

8LT Connectors

MIL-DTL-38999 Serie I

8LT Connectors



SOURIAU

Connectors and interconnect systems for severe environments

The company designs, manufactures and markets high performance interconnect solutions for severe environments from industrial broadline and universal ranges to complex system with integrated functions: filtering, high speed data transmission, hermetic seal, separation mechanism, remote handling, underwater mating, ...



Industrial



Aeronautical



Equipment & System

The dedicated end markets for SOURIAU's products are aeronautical, defense-space and industrial.



Railway
Geophysics
Manufacturing environment
Instrumentation
Automation & process



Civil & military aircraft
Helicopter
Weapon delivery system
Avionics



Military marine
Communications
Satellites
Launcher & missile

SOURIAU was established in 1917 and has been created by successive acquisitions of the industrial, aeronautical, defense and space activities of SOURIAU, JUPITER and BURNDY.

The Group's products are engineered and manufactured in the USA and Dominican Republic, Europe and Morocco, Japan and India, and sold by a worldwide sales and marketing organization, and in addition to SOURIAU's offices, a large network of licensed distributors and agents.

SOURIAU complies with most of national and international Quality Assurance Standards, production unit with ISO 14001.

Quality Certificate
Management System

ISO 9001

Environment Certificate
Management System

ISO 14001

Quality Certificate
Management System

Aeronautic Industry : EN 9100

8LT Connectors

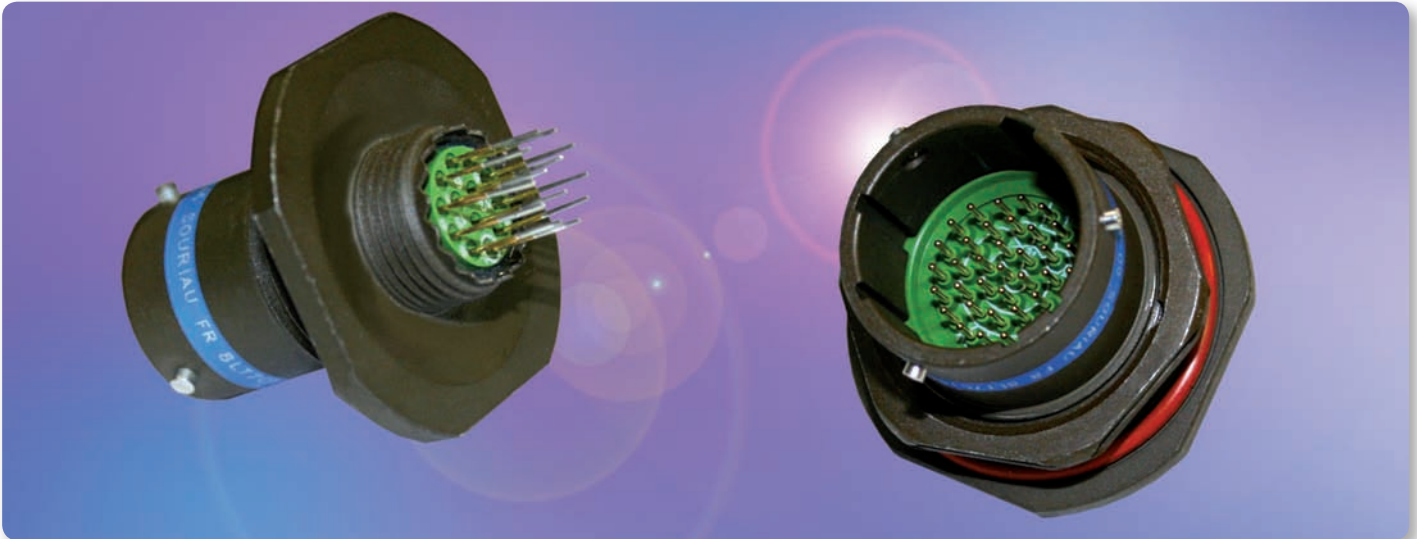

Presentation

Miniature connectors with high reliability and high contact density

This 8LT product family is qualified in accordance to the MIL-DTL-38999 series I.

Originally designed to meet the high performance needs of the aerospace industries & military applications, it is also now used in varied applications needing extremely reliable interconnections with high density contact arrangements in a miniature circular shell.

Benefit to the customer

- Weight and Space Saving
- Quick Mating - 3 point bayonet lock system
- Mismatching, error proof positioning – keyway polarization (5 positions)
- High choice of Insert arrangements (customization possible, please consult us)
- Range extension available or on demand (Rack Panel, Potted, Hermetics, Low Profile, Filters, etc..), please consult us
- Versatility thanks to our inserts as for the series III (except for 8LT type 2) with full range of crimp contacts interchangeable
- Gold plated crimp or spill contacts are rear removable and retained in the insulator by a metal clip.
- RoHS version available (cadmium free)

Contents

• Presentation	03
• Technical feature & benefits	04
• Cross reference list	06
• Mated connectors with backshells	08
• Mated connectors dimensions	12
• Contact layouts	14
• Contact layouts (matrix)	18
• Part numbers	20
• Dimensions	23
• Rack & panel	28
• Contacts	32
• Orientations	37
• Accessories (Protective caps, Tooling, ...)	38
• Wiring instructions	42
• Backshells	44
• Cost effective & light hermetic / Resin sealed	46
• Coordinates for straight spill terminations	48

8LT Connectors



Description

- High contact density
- Bayonet coupling
- Contact protection : 100% Scoop proof
- Shell size from 9 to 25
- Accessories available (protective caps, backshells, etc...)
- RFI - EMI shielding and shell to shell continuity
- Hermetic
- Alluminium alloy, protection by cadmium, nickel, green zinc cobalt or black zinc nickel plating

Applications

- Civil and Military Aerospace
- Marine Equipments
- Communications Equipements
- Medical Instrumentation
- Ballistic Missiles & Weapon Systems
- Armored Carriers & Tanks
- Test Equipments

Technical features

Mechanical

- Shell: aluminum alloy
- Plating:
 - . olive green cadmium (B)
 - . nickel (F)
 - . green zinc cobalt (Z)
 - . black zinc nickel (L)
- Insulator: thermoplastic or metallic version available for specification 284 & 384
- Grommet or seal: liquid silicone rubber or fluorocarbone elastomer for specification 022
- Contact: copper alloy
- Plating contact: gold over nickel
- Endurance: 500 mating / unmating operations

- Chock: 300 g during 3 ms and as per MIL S 901 grade A
- Vibration:
 - . Sine 10 to 2000 Hz - 30 g
 - . Random 100 à 300 Hz - 5 g²/Hz
- Contact retention (min force in N):
 - . Size 22D: 44 N
 - . Size 20: 67 N
 - . Size 16: 111 N
 - . Size 12: 111 N
 - . Size 8: 111 N
 - . Size 4: 200 N

Electrical

- Test voltage (Vrms)

Service	sea level	at 21 000 m
M	1 300	800
N	1 000	600
I	1 800	1 000
II	2 300	1 000

- Insulation resistance: $\geq 5\ 000\ MW$ (at 500 Vcc)
- Contact resistance:
 - resistance of wire included in measurement
 - . size 22D: 14.6 m Ω
 - . size 20: 7.3 m Ω
 - . size 16: 3.8 m Ω
 - . size 12: 3.5 m Ω
 - . size 8: 3 m Ω
 - . size 4: 2 m Ω
- Contact rating:
 - . size 22D: 5 A
 - . size 20: 7.5 A
 - . size 16: 13 A
 - . size 12: 23 A
 - . size 8: 45 A
 - . size 4: 80 A
- Shell continuity:
 - . olive green plating: 2.5 m Ω
 - . nickel plating: 1 m Ω
 - . green zinc cobalt: 2.5 m Ω
 - . black zinc nickel: 2.5 m Ω

- Shielding: 90 db at 100 MHz, 50 db at 10 000 MHz
- Electrical continuity between contact and shell for specification 284 & 384: 10 m Ω max

Climatic

- Temperature range:
 - . olive green cadmium plating (B)
 - 65°C +175°C
 - . nickel plating (F)
 - 65°C +200°C
 - . green zinc cobalt plating (Z)
 - 65°C +200°C
 - . black zinc nickel plating (L)
 - 65°C +200°C
- Sealing: mated connectors
 - Differential pressure 2 bars:
 - leakage $\leq 16\ cm^3/h$
- Salt spray as per:
 - . MIL STD 1344 method 1001 :
 - 500 hours (versions B, L and Z)
 - 48 hours (version F)
 - . NFC 93422 :
 - 48 hours (version F)
- Resistance to fluids
 - . As per MIL DTL 38999, hydraulic fluids, solvents
 - . Specification 022 for fuel immersion (please consult us)

8LT Connectors



Cross reference list :

Part Numbers Souriau and Specifications : NFC 93422 / MIL DTL 38999

Connectors

SOURIAU	NFC 93422 HE 308	MIL DTL 38999 Serie I	Designation
8LT1●●B●●P/SN 8LT1●●F●●P/SN	- -	- -	Cable connecting receptacle
8LT0●●B●●P/SN 8LT0●●F●●P/SN	HE30800T●●●●●P/SN7 M HE30800T●●●●●P/SN6 M	MS27466T●●B●●P/S●* MS27466T●●F●●P/S●*	Square flange receptacle
8LT2●●B●●P/SN 8LT2●●F●●P/SN	- -	MS27505E●●B●●P/S●* MS27505E●●F●●P/S●*	Square flange receptacle not accepting backshell
8LT3●●B●●P/SN 8LT3●●F●●P/SN	- -	MS27656T●●B●●P/S●* MS27656T●●F●●P/S●*	Square flange receptacle (rear mounting)
8LT5●●B●●P/SN 8LT5●●F●●P/SN	HE30806T●●●●●P/SN7 M HE30806T●●●●●P/SN6 M	MS27467T●●B●●P/S●* MS27467T●●F●●P/S●*	Plug with RFI shielding
8LT15●●B●●P/SN 8LT15●●F●●P/SN	- -	MS27467E●●B●●P/S●* MS27467E●●F●●P/S●*	Plug with RFI shielding not accepting backshell
8LT7●●B●●P/SN 8LT7●●F●●P/SN	HE30807T●●●●●P/SN7 M HE30807T●●●●●P/SN6 M	MS27468T●●B●●P/S●* MS27468T●●F●●P/S●*	Jam nut receptacle
8LT7S●●B●●P/SN (#22D) 8LT7S●●F●●P/SN (#22D)	HE30811T●●●●●P/SN7 M HE30811T●●●●●P/SN6 M	- -	Jam nut receptacle with straight spill contacts
8LT7C●●B●●P/SN (#20, #16, #12) 8LT7C●●F●●P/SN (#20, #16, #12)	HE30811T●●●●●P/SN7 M HE30811T●●●●●P/SN6 M	- -	Jam nut receptacle with straight spill contacts
8LT26●●B●●P/SN 8LT26●●F●●P/SN	HE30826T●●●●●P/SN7 M -	- -	Floating plug for rack HE308
8LT27●●B●●P/SN 8LT27●●F●●P/SN	HE30827T●●●●●P/SN7 M -	- -	Receptacle for rack HE308 with possibility to mount rear accessories
8LT27S●●B●●P/SN (#22D) 8LT27C●●B●●P/SN (#20, #16, #12)	HE30821T●●●●●P/SN7 M HE30821T●●●●●P/SN7 M	- -	Receptacle for rack HE308 with straight spill contacts
8LT23●●B●●P/SN	-	-	Square flange receptacle

* Standard P/S : . None = N position,
. Use A,B,C,D for other orientations

Backshells

SOURIAU	NFC 93422 HE 308	MIL DTL 38999 Serie I	Designation
8LST●●●B01 8LST●●●F01	- -	M8504927●●W M8504927●●N	Backnut
8LST●●●B02 8LST●●●F02 8LST●●●G02	- HE308-11●●●26 HE308-11●●●27	- - -	Straight cable clamp
8LST●●●B03 8LST●●●F03 8LST●●●G03	- HE308-12●●●26 HE308-12●●●27	- - -	Elbow cable clamp
8LST●●●B071 8LST●●●F071	HE308-13●●●17 HE308-13●●●16	- -	Backshell for screen termination and heatshrink sleeving

8LT Connectors



Caps

SOURIAU	NFC 93422 / HE 308	MIL DTL 38999 Serie I	Designation
8LTE04B●● 8LTE04F●●	HE308-B00●●7 HE308-B00●●6	- -	Cap for square flange receptacle
8LTE06B●● 8LTE06F●●	HE308-B07●●7 HE308-B07●●6	- -	Cap for jam nut receptacle
8LTF05B●● 8LTF05F●●	HE308-B16●●7 HE308-B16●●6	- -	Cap for plug
8LTF07B●● 8LTF07F●●	HE308-B06●●7 HE308-B06●●6	- -	Cap for plug
8LTE01B●● 8LTE01F●●	- -	MS27502B●●C MS27502F●●C	Cap for receptacle
8LTE02B●● 8LTE02F●●	- -	MS27502B●●N MS27502F●●N	Cap for receptacle
8LTF01B●● 8LTF01F●●	- -	MS27501B●●C MS27501F●●C	Cap for plug

Contacts

See pages 32 to 36

Filler plug

Contact size	Part Number		Colour
	SOURIAU	MIL DTL 38999 serie I	
#22D	8660-212	MS27488-22	Black
#20	8522-389A	MS27488-20	Red
#16	8522-390A	MS27488-16	Blue
#12	8522-391A	MS27488-12	Yellow

Insertion and extraction tools

Contact size	Part Number		Colour	
	SOURIAU	MIL DTL 38999 Serie I	Insertion	Extraction
#22D	8599-0022	M81969/14-01	Green	White
#20	8522-20	M81969/14-10	Red	Orange
#16	8522-16	M81969/14-03	Blue	White
#12	8522-12	M81969/14-04	Yellow	White

For other contact size see page 41

8LT Connectors



Mated connectors with backshells

Mated plug : Dimension from panel to backshell

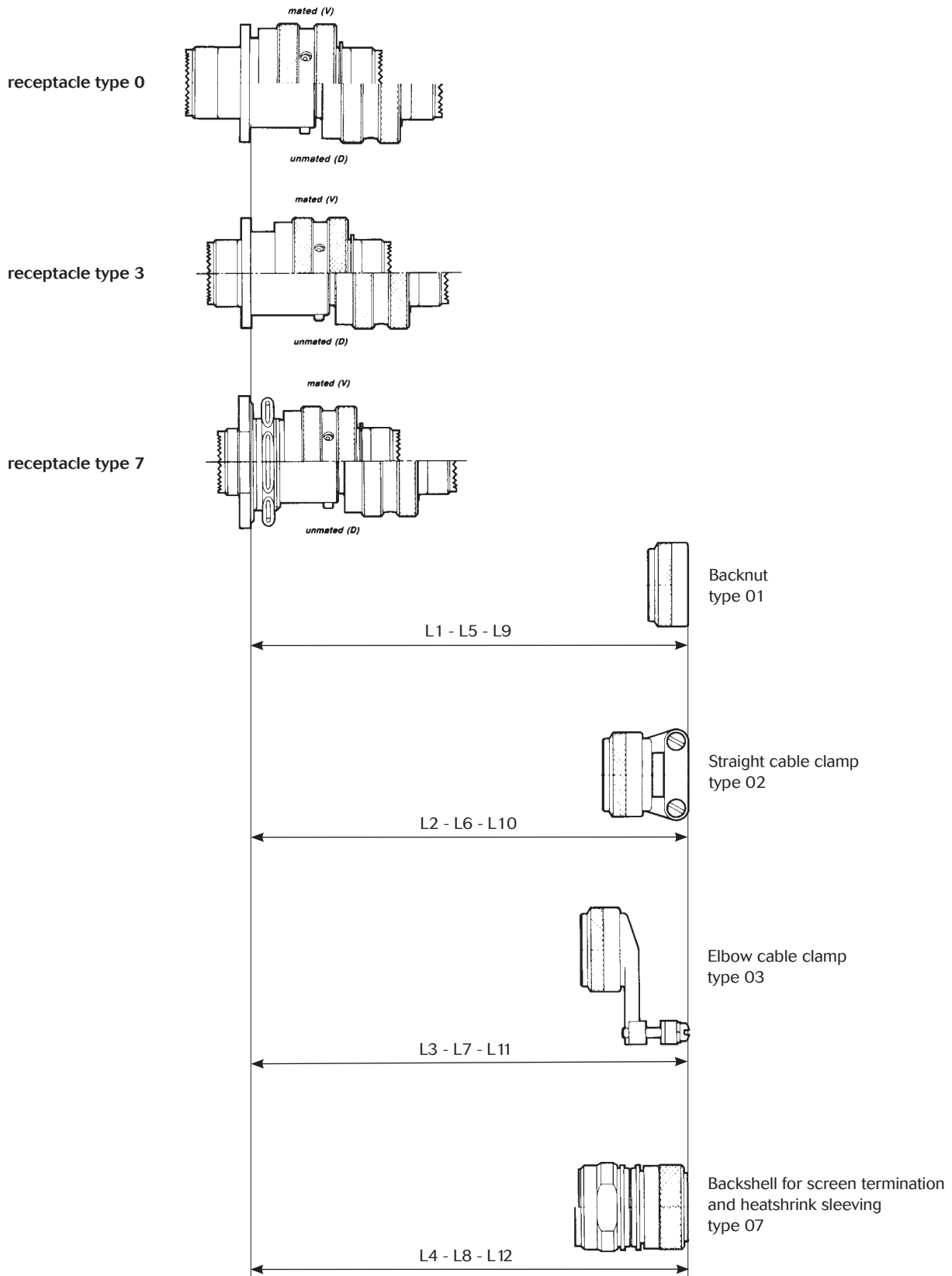

8LT Connectors



Square flange receptacle type 0 Cable connecting receptacle type 1								
Shell size	L1 Max		L2 Max		L3 Max		L4 Max	
	V	D	V	D	V	D	V	D
09	40.20	55.20	50.75	65.75	64.20	79.20	55.75	70.75
11	40.20	55.20	51.75	66.55	64.20	79.20	55.75	70.75
13	40.20	55.20	53.05	68.05	66.20	81.20	55.75	70.75
15	40.20	55.20	59.45	74.45	70.56	85.56	57.75	72.75
17	40.20	55.20	62.95	77.95	74.93	89.93	57.75	72.75
19	40.20	55.20	62.95	77.95	75.34	90.34	58.75	73.75
21	40.20	55.20	62.95	77.95	77.32	92.32	62.55	77.55
23	40.20	55.20	62.95	77.95	80.87	95.87	62.55	77.55
25	40.20	55.20	62.95	77.95	83.67	98.67	62.55	77.55

Square flange receptacle type 3								
Shell size	L5 Max		L6 Max		L7 Max		L8 Max	
	V	D	V	D	V	D	V	D
09	42.50	57.50	53.05	68.05	66.50	81.50	58.05	72.05
11	42.50	57.50	54.05	68.05	66.50	81.50	58.05	72.05
13	42.50	57.50	55.80	7.35	65.50	83.50	58.05	72.05
15	42.50	57.50	61.75	76.75	78.86	87.86	60.05	75.05
17	42.50	57.50	65.25	80.25	77.23	92.23	60.05	75.05
19	42.50	57.50	65.25	80.25	77.64	92.64	61.05	76.05
21	41.75	56.75	64.50	79.50	78.87	93.87	64.10	79.10
23	41.75	56.75	64.50	79.50	82.42	97.42	64.10	79.10
25	41.75	56.75	64.50	79.50	85.22	100.22	64.10	79.10

Jam nut receptacle type 7								
Shell size	L9 Max		L10 Max		L11 Max		L12 Max	
	V	D	V	D	V	D	V	D
09	45.02	60.02	55.58	70.58	69.04	84.04	60.58	75.58
11	45.02	60.02	56.38	71.38	69.04	84.04	60.58	75.58
13	45.02	60.02	57.88	72.88	71.02	84.04	60.58	75.58
15	45.02	60.02	64.28	79.28	75.39	86.02	62.58	77.58
17	45.02	60.02	67.78	82.78	79.76	90.39	62.58	77.58
19	45.02	60.02	67.78	82.78	80.17	94.76	63.58	78.58
21	45.02	60.02	67.78	82.78	82.15	95.17	67.38	82.38
23	45.02	60.02	67.78	82.78	85.70	100.70	67.38	82.38
25	45.02	60.02	67.78	82.78	88.50	103.50	67.38	82.38

8LT Connectors



Plug or receptacle backshell assembly overall length

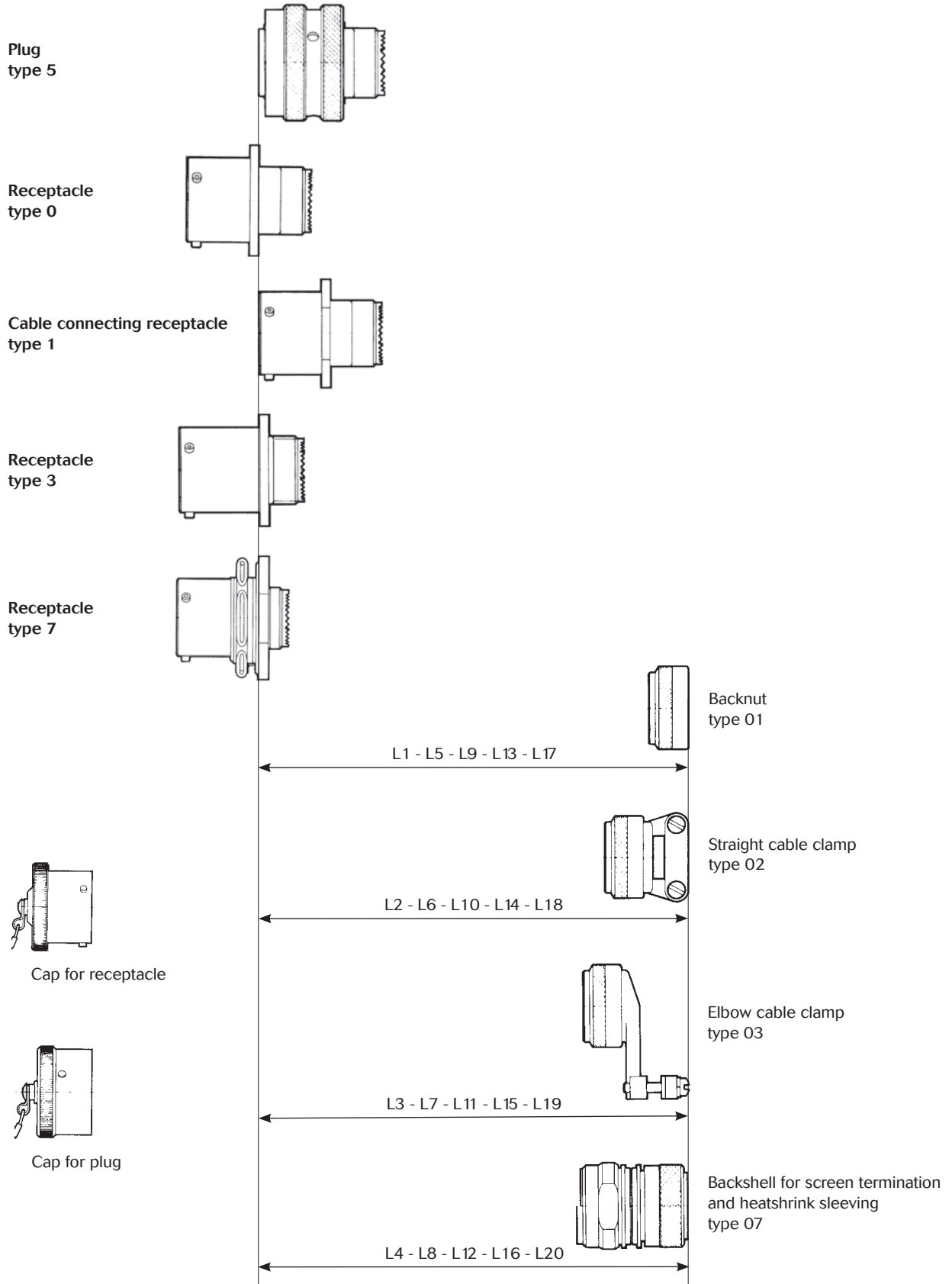

8LT Connectors



Plug type 5				
Shell size	L1 Max	L2 Max	L3 Max	L4 Max
09	36.66	47.22	60.68	52.22
11	36.66	48.02	60.68	52.22
13	36.66	49.52	62.66	52.22
15	36.66	55.92	67.03	54.22
17	36.66	59.42	71.40	54.22
19	36.66	59.42	71.81	55.22
21	36.66	59.42	73.79	59.02
23	36.66	59.42	77.34	59.02
25	36.66	59.42	80.14	59.02

Receptacle type 0				
Shell size	L5 Max	L6 Max	L7 Max	L8 Max
09	18.83	29.39	42.85	34.39
11	18.83	30.19	42.85	34.39
13	18.83	31.69	44.83	34.39
15	18.83	38.09	51.00	36.39
17	18.83	41.59	53.57	36.39
19	18.83	41.59	53.98	37.39
21	18.83	41.59	55.98	41.19
23	18.83	41.59	59.51	41.19
25	18.83	41.59	62.31	41.19

Cable connecting receptacle type 1				
Shell size	L9 Max	L10 Max	L11 Max	L12 Max
09	37.36	47.98	61.38	52.92
11	37.36	48.72	61.38	52.92
13	37.36	50.22	63.36	52.92
15	37.36	56.62	69.53	54.92
17	37.36	60.12	72.10	54.92
19	37.36	60.12	72.51	55.92
21	37.36	60.12	74.49	59.72
23	37.36	60.12	78.04	59.72
25	37.36	60.12	80.84	59.72

Receptacle type 3				
Shell size	L13 Max	L14 Max	L15 Max	L16 Max
09	15.85	26.40	39.90	31.40
11	15.85	27.20	39.90	31.40
13	15.85	28.70	41.90	31.40
15	15.85	35.10	48.10	33.40
17	15.85	38.60	50.60	33.40
19	15.85	38.60	51.00	34.40
21	15.85	39.40	53.80	39.00
23	15.85	39.40	57.30	39.00
25	15.85	39.40	60.10	39.00

Receptacle type 7				
Shell size	L17 Max	L18 Max	L19 Max	L20 Max
09	13.66	24.22	37.68	29.22
11	13.66	25.22	37.68	29.22
13	13.66	26.52	39.66	29.22
15	13.66	32.92	45.83	31.22
17	13.66	36.42	48.40	31.22
19	13.66	36.42	48.81	32.22
21	13.66	36.42	50.79	36.02
23	13.66	36.42	54.34	36.02
25	13.66	36.42	57.14	36.02

8LT Connectors



Mated connectors dimensions

Type 0 with plug
(type 5)

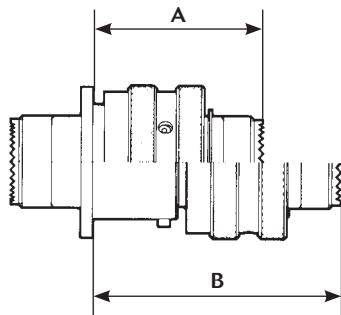

Type 7 with plug
(type 5)

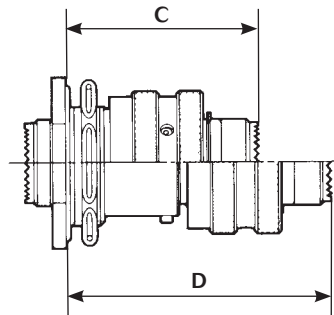

Shell Size	A Max	B Max	C Max	D Max
09	33.30	47.40	40.60	54.70
11				
13				
15				
17				
19	32.50	46.70	40.60	54.70
21				
23				
25				

8LT Connectors



Contact layouts

09

35	98
6#22D	3#20
Service M	Service I

Contact #22D	Contact #8 Triax
Contact #20	Contact #8 Power
Contact #16	Contact #8 Quadrax
Contact #12	Contact #4 Power
Contact #10	

11

01	02	04	05	22*
1#12	2#16	4#20	5#20	4#22D
Service II	Service I	Service I	Service I	Service M
35	80	81	98	99
13#22D	1#8 triax	1#8 quadrax	6#20	7#20
Service M	Service I		Service I	Service I

13

03	04	08	26	35	98
3#16	4#16	8#20	6#22D 2#12	22#22D	10#20
Service I	Service I	Service I	Service M	Service M	Service I

* Available on specific request. Please consult us.

Ethernet Quadrax

8LT Connectors



15

05	15	18	19	35	97
5#16 Service II	14#20 1#16 Service I	18#20 Service I	19#20 Service I	37#22D Service M	8#20 4#16 Service I

17

02	06	08	20*	26
38#22D 1#8 triax Service M	6#20 Service I	8#16 Service II	16#22D 4#12 Service M	26#20 Service I
35	75	81	82	99
55#22D Service M	2#8 triax Service M	38#22D 1#8 quadrax	2#8 quadrax	2#16 21#20 Service I

19

11	18	28	32	35
11#16 Service II	14#22D 4#8 triax Service M	26#20 2#16 Service I	32#20 Service I	66#22D Service M

* Available on specific request. Please consult us.

Ethernet Quadrax

8LT Connectors



21

11	16	35	39	41
11#12 Service I	16#16 Service II	79#22D Service M	37#20 2#16 Service I	41#20 Service I
48	75	78	84	
4#8 power Service I	4#8 triax Service M	17#22 2#8 coax Service M	4#8 quadrax	

23

21	32	35	53	54	55
21#16 Service I	32#20 Service I	100#22D Service M	53#20 Service I	40#22D 9#16 4#12 Service M	55#20 Service I

8LT Connectors



25

<p>04</p> <p>48#20 8#16 Service I</p>	<p>07</p> <p>97#22D 2#8 triax Service M</p>	<p>08*</p> <p>8#8 triax Service M</p>	<p>11*</p> <p>2#20 9#10 Service N</p>	<p>19</p> <p>19#12 Service I</p>	<p>24</p> <p>12#12 12#16 Service II</p>
<p>29</p> <p>29#16 Service I</p>	<p>35</p> <p>128#22D Service M</p>	<p>37</p> <p>37#16 Service I</p>	<p>41</p> <p>22#22D 3#20 11#16 2#12 3#8 triax Service N</p>	<p>43</p> <p>20#16 23#20 Service I</p>	<p>44</p> <p>4#4 power 4#16 Service I</p>
<p>46</p> <p>40#20 4#16 2#8 coax Service I</p>	<p>61</p> <p>61#20 Service I</p>	<p>80</p> <p>10#20 13#16 4#12 3#8 quadrax Service N</p>	<p>81</p> <p>22#22D 3#20 11#16 2#12 3#8 quadrax Service N</p>	<p>82</p> <p>97#22D 2#8 quadrax Service M</p>	<p>86</p> <p>40#20 4#16 2#8 quadrax Service I</p>
<p>88*</p> <p>8#8 quadrax</p>					

* Available on specific request. Please consult us.

Ethernet Quadrax

8LT Connectors



Contact layouts (matrix)

Shell Size	Layout	Service	8LT	8LT2	MIL - DTL - 38999 (QPL)		HE 308		Nber of Contacts	# 22D	# 20	# 16	# 12	# 10	# 8	#4 Power
					MS (1)	MS27505	Not Rack	Rack								
09 / A	09 - 35	M					O	X		6	6					
	09 - 98	I					O	X		3		3				
11 / B	11 - 01	II							*	1				1		
	11 - 02	I							*	2		2				
	11 - 04	I							*	4		4				
	11 - 05	I							*	5		5				
	11 - 22	M								4	4					
	11 - 35	M					O	X	*	13	13					
	11 - 80	I								1					1 Triax	
	11 - 81	-								1					1 Quadrax	
	11 - 98	I					O	X	*	6		6				
11 - 99	I							*	7		7					
13 / C	13 - 03	I								3		3				
	13 - 04	I					O		*	4		4				
	13 - 08	I							*	8		8				
	13 - 26	M								8	6			2		
	13 - 35	M					O	X	*	22	22					
	13 - 98	I					O	X	*	10		10				
15 / D	15 - 05	II					O	X	*	5		5				
	15 - 15	I							*	15		14	1			
	15 - 18	I					O		*	18		18				
	15 - 19	I					O	X	*	19		19				
	15 - 35	M					O	X	*	37	37					
	15 - 97	I					O	X	*	12		8	4			
17 / E	17 - 02	M								39	38				1 Triax	
	17 - 06	I					O		*	6		6				
	17 - 08	II					O	X	*	8		8				
	17 - 20	M								20	16			4		
	17 - 26	I					O	X	*	26		26				
	17 - 35	M					O	X	*	55	55					
	17 - 75	M							*	2					2 Triax	
	17 - 81	-								39	38				1 Quadrax	
	17 - 82	-								2					2 Quadrax	
17 - 99	I					O	X	*	23		21	2				

(1) available MS27466 & MS27467 & MS27468 & MS27656



SOURIAU's layout

Qualified Layout (QPL) MIL - DTL 38999

X Qualified Layout HE308 for «ministère de la défense» DGA DTAT

O Layout according to UTE C 93-422 norm

* Layout according to C5935X0005 norm

8LT Connectors



Contact layouts (matrix)

Shell Size	Layout	Service	8LT	8LT2	MIL - DTL - 38999 (QPL)		HE 308		Nber of Contacts	# 22D	# 20	# 16	# 12	# 10	# 8	#4 Power
					MS (1)	MS27505	Not Rack	Rack								
19 / F	19 - 11	II					O	X	*	11			11			
	19 - 18	M								18	14				4 Triax	
	19 - 28	I							*	28		26	2			
	19 - 32	I						O	X	*	32		32			
	19 - 35	M						O	X	*	66	66				
21 / G	21 - 11	I					O	X	*	11				11		
	21 - 16	II					O	X	*	16			16			
	21 - 35	M					O	X	*	79	79					
	21 - 39	I					O		*	39		37	2			
	21 - 41	I					O	X	*	41		41				
	21 - 48	I								4						4 Power
	21 - 75	-							*	4						4 Triax
	21 - 78	M								19	17					2 Coax
21 - 84	-								4						4 Quadrax	
23 / H	23 - 21	II					O		*	21			21			
	23 - 32	I								32		32				
	23 - 35	M					O	X	*	100	100					
	23 - 53	I					O	X	*	53		53				
	23 - 54	M								53	40		9	4		
23 - 55	I							*	55		55					
25 / J	25 - 04	I								56		48	8			
	25 - 07	M								99	97					2 Triax
	25 - 08	-								8						8 Triax
	25 - 11	N								11		2			9	
	25 - 19	I					O	X		19				19		
	25 - 24	II								24			12	12		
	25 - 29	I					O	X		29			29			
	25 - 35	M					O	X		128	128					
	25 - 37	I								37			37			
	25 - 41	N								41	22	3	11	2		3 Triax
	25 - 43	I								43		23	20			
	25 - 44	I								8			4			4
	25 - 46	I								46		40	4			2 Coax
	25 - 61	I					O	X		61		61				
	25 - 80	N								30		10	13	4		3 Quadrax
	25 - 81	N								41	22	3	11	2		3 Quadrax
	25 - 82	M								99	97					2 Quadrax
25 - 86	I								46		40	4			2 Quadrax	
25 - 88	-								8						8 Quadrax	

(1) available MS27466 & MS27467 & MS27468 & MS27656

	SOURIAL's layout
	Qualified Layout (QPL) MIL - DTL 38999

X	Qualified Layout HE308 for «ministère de la défense» DGA DTAT
O	Layout according to UTE C 93-422 norm
*	Layout according to C5935X0005 norm

8LT Connectors



Souriau connector part numbers

Basic series	8LT	0	-	13	B	35	P	N	***	-	L
Shell type											
<ul style="list-style-type: none"> 0: Square flange receptacle 1: Cable connecting receptacle 2: Short square flange receptacle, not accepting backshell 3: Square flange receptacle (rear mounting) 5: Plug with RFI shielding 7: Jam nut receptacle 15: Plug with RFI shielding, not accepting backshell 											
Type											
<ul style="list-style-type: none"> None: Connector with standard crimp contacts L: Connector with long spill (male and female #22D) C: Connector with short spill (male and female #22D, #20, #16, #12, #8 quadrax) T: Connector with male contact size 20 for wire wrap (2 wraps) W: Connector with male contact size 22D for wire wrap (3 wraps) S: Connector with specific straight spill (male and female #22D only) Q: Connector with quadrax crimp contacts 											
Shell size											
09 - 11 - 13 - 15 - 17 - 19 - 21 - 23 - 25											
Plating											
<ul style="list-style-type: none"> F: Nickel B: Olive green cadmium Z: Green zinc cobalt L: Black zinc nickel 											
Contact layout											
See tables pages 14 to 19											
Contact type											
<ul style="list-style-type: none"> P: Male A: Connector supplied less pin contact or with specific contacts (Connector marking : A + orientation) S: Female B: Connector supplied less socket contact or with specific contacts (Connector marking : B + orientation) 											
Orientation (1)											
N, A, B, C, D see table page 37											
Specifications											
<ul style="list-style-type: none"> None: Supplied with contact 046: Straight spill contact with tinned plating 251: Connector provided with power contacts with layout contacts #8 022: Fuel tank Please consult us 											
<ul style="list-style-type: none"> *284: Quadrax grounded (cts 100) (2) 308: Quadrax not grounded (cts 100) (2) *384: Quadrax grounded (cts 150) (2) 408: Quadrax not grounded (cts 150) (2) 											
Special custom											
<ul style="list-style-type: none"> None: Standard plastic cap M: Antistatic plastic cap 											
L: For P or S contact type only, connector delivered without contacts, connector marking P or S (without L)											

*Excepted mixed layouts with quadrax and signal contacts. Please consult us.

(1) Orientations B & C not developed for shell size number 9.

(2) Type shell 0, 3 and 5 available only.

8LT Connectors



MIL DTL 38999 part numbers

Basic series	MS	27466	T	13	B	35	P	-	-	L
Shell type										
27466: Square flange receptacle (front mounting)										
27656: Square flange receptacle (rear mounting)										
27468: Jam nut receptacle										
27467: Plug with RFI shielding										
27505: Square flange receptacle, not accepting backshell										
Class										
E: Without thread for back fitting, not accepting backshell for MS27505 and MS27467 only										
T: With thread for backfitting, supplied without backshell (excepted MS27505)										
Shell size										
09 - 11 - 13 - 15 - 17 - 19 - 21 - 23 - 25										
Plating										
F: Nickel B: Olive green cadmium										
Contact layout										
See tables pages 14 to 19										
Contact type										
P: Male A: Connector supplied less pin contact or with specific contacts (Connector marking : A + orientation)										
S: Female B: Connector supplied less socket contact or with specific contacts (Connector marking : B + orientation)										
Orientation (1)										
None: Normal (N)										
A, B, C, D see table page 37										
Special custom										
None: Standard plastic cap										
M: Antistatic plastic cap										
L: For P or S contact type only, connector delivered without contacts, connector marking P or S (without L)										

(1) Orientations B & C not developed for shell size number 9.

8LT Connectors



HE 308 part numbers

Basic series	HE308	00	T	13	35	P	N	7	M	-	L
Shell type											
00: Square flange receptacle											
07: Jam nut receptacle											
06: Plug with RFI shielding											
11: Jam nut receptacle with straight spill contacts											
Class											
T: Sealed											
Shell size											
09 - 11 - 13 - 15 - 17 - 19 - 21 - 23 - 25											
Contact layout											
See tables pages 14 to 19											
Contact type											
P: Male											
S: Female											
Orientation (1)											
N, A, B, C, D see table page 37											
Plating											
6: Nickel											
7: Olive green cadmium											
Contractual spécification											
Special custom											
None: Standard plastic cap											
M: Antistatic plastic cap											
Specification											
None: Connector supplied with contact											
L: connector supplied without contact											

(1) Orientations B & C not developed for shell size number 9.

8LT Connectors



Dimensions

Receptacle type 0

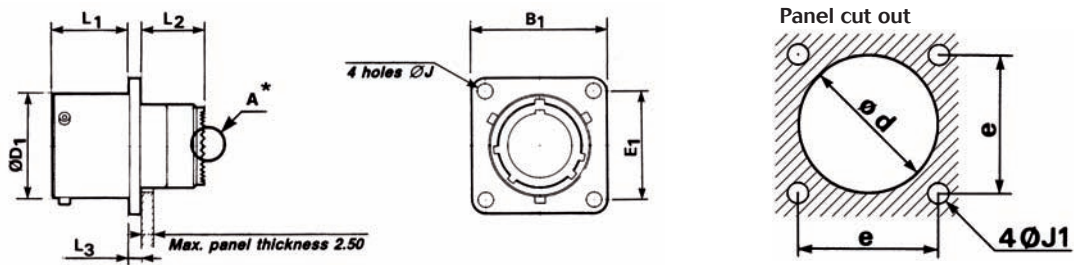

Shell size		09	11	13	15	17	19	21	23	25
B1	Min	23.70	26.05	28.50	30.85	33.20	36.40	39.55	42.75	46.00
	Max	24.30	26.70	29.05	31.45	33.80	37.00	40.15	43.35	46.50
E1		18.26	20.62	23.01	24.61	26.97	29.36	31.75	34.93	38.10
D1	Min	14.40	17.65	21.40	24.65	27.82	29.24	33.70	36.92	40.06
	Max	14.53	17.78	21.59	24.77	27.94	30.66	33.83	37.00	40.18
J	Min	3.25	3.25	3.25	3.25	3.25	3.25	3.25	3.73	3.73
	Max	3.35	3.35	3.35	3.35	3.35	3.35	3.35	3.83	3.83
L1	Min	15.93	15.93	15.93	15.93	15.93	15.93	15.17	15.17	15.17
	Max	16.05	16.05	16.05	16.05	16.05	16.05	15.29	15.29	15.29
L2	Min	13.23	13.23	13.23	13.23	13.23	13.23	13.23	13.23	13.23
	Max	13.49	13.49	13.49	13.49	13.49	13.49	13.49	13.49	13.49
L3	Min	2.14	2.14	2.14	2.14	2.14	2.14	2.90	2.90	2.90
	Max	2.54	2.54	2.54	2.54	2.54	2.54	3.30	3.30	3.30
d	Min	15.70	18.70	21.80	25.00	28.30	31.00	34.20	37.30	40.50
J1	± 0.15	3.25	3.25	3.25	3.25	3.25	3.25	3.25	3.91	3.91
e		18.26	20.62	23.01	24.61	26.97	29.36	31.75	34.92	38.10

* Detail A see page 27

Cable connecting receptacle type 1

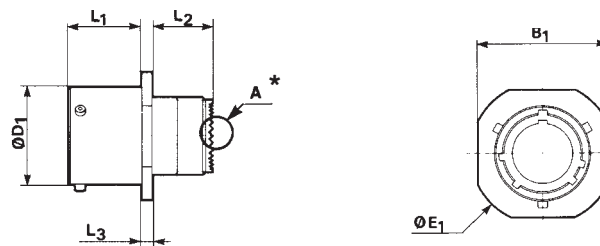

Shell size		09	11	13	15	17	19	21	23	25
B1	Min	18.35	21.65	25.05	27.25	30.78	34.05	37.45	41.45	45.93
	Max	18.92	22.22	25.62	27.82	31.35	34.62	38.02	42.02	46.50
E1	Min	21.80	25.10	28.50	30.70	34.10	37.50	40.90	44.90	49.40
	Max	22.35	25.65	29.05	31.25	34.65	38.05	41.45	45.45	49.95
D1	Min	14.40	17.65	21.40	24.65	27.82	29.24	33.70	36.92	40.06
	Max	14.53	17.78	21.59	24.77	27.94	30.66	33.83	37.00	40.18
L1	Min	15.93	15.93	15.93	15.93	15.93	15.93	15.17	15.17	15.17
	Max	16.05	16.05	16.05	16.05	16.05	16.05	15.29	15.29	15.29
L2	Min	13.23	13.23	13.23	13.23	13.23	13.23	13.23	13.23	13.23
	Max	13.45	13.45	13.45	13.45	13.45	13.45	13.45	13.45	13.45
L3	Min	2.14	2.14	2.14	2.14	2.14	2.14	2.90	2.90	2.90
	Max	2.54	2.54	2.54	2.54	2.54	2.54	3.30	3.30	3.30

* Detail A see page 27

8LT Connectors



Receptacle type 3

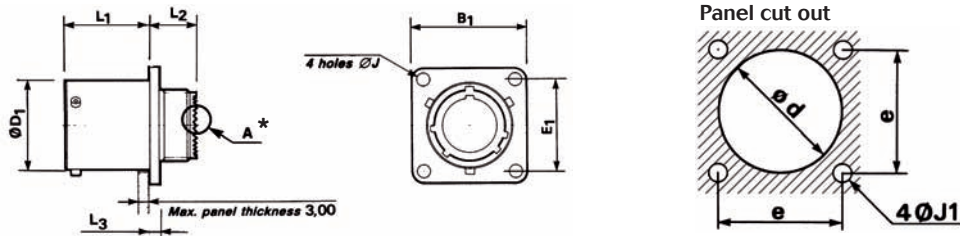

Shell size		09	11	13	15	17	19	21	23	25
B1	Min	23.70	26.05	28.50	30.85	33.20	36.40	39.55	42.75	46.00
	Max	24.30	26.70	29.05	31.45	33.80	37.00	40.15	43.35	46.50
E1		18.26	20.62	23.01	24.61	26.97	29.36	31.75	34.93	38.10
D1	Min	14.40	17.65	21.40	24.65	27.82	29.24	33.70	36.92	40.06
	Max	14.53	17.78	21.59	24.77	27.94	30.66	33.83	37.00	40.18
J	Min	3.25	3.25	3.25	3.25	3.25	3.25	3.25	3.73	3.73
	Max	3.35	3.35	3.35	3.35	3.35	3.35	3.35	3.83	3.83
L1	Min	20.71	20.71	20.71	20.71	20.71	20.71	19.96	19.96	19.96
	Max	20.83	20.83	20.83	20.83	20.83	20.83	20.08	20.08	20.08
L2	Min	10.40	10.40	10.40	10.40	10.40	10.40	11.15	11.15	11.15
	Max	11.90	11.90	11.90	11.90	11.90	11.90	12.70	12.70	12.70
L3	Min	2.14	2.14	2.14	2.14	2.14	2.14	2.90	2.90	2.90
	Max	2.54	2.54	2.54	2.54	2.54	2.54	3.30	3.30	3.30
d	Min	16.66	20.22	23.42	26.59	30.96	32.94	36.12	39.29	42.47
J1	± 0.15	3.25	3.25	3.25	3.25	3.25	3.25	3.25	3.91	3.91
e		18.26	20.62	23.01	24.61	26.97	29.36	31.75	34.92	38.10

* Detail A see page 27

Receptacle type 7 & HE 308 type 11

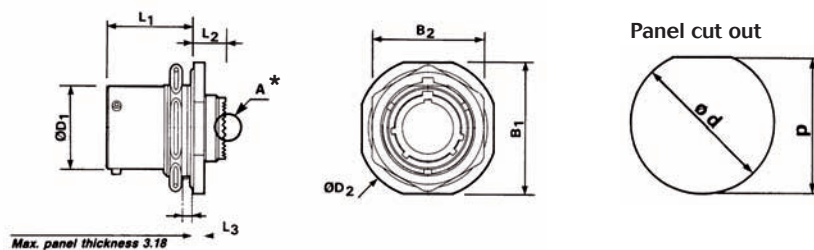

Shell size		09	11	13	15	17	19	21	23	25
B1	Min	26.60	31.40	34.60	37.80	40.90	45.63	48.84	52.02	55.19
	Max	27.35	32.10	35.31	38.49	41.63	46.37	49.58	52.76	55.93
B2	Min	21.95	25.15	29.80	33.05	36.25	39.40	42.60	45.75	50.65
	Max	22.35	25.55	30.30	33.45	36.65	39.80	43.00	46.15	50.95
D1	Min	14.40	17.65	21.40	24.65	27.82	29.24	33.70	36.92	40.06
	Max	14.53	17.78	21.59	24.77	27.94	30.66	33.83	37.00	40.18
D2	Min	29.90	34.60	37.75	41.00	44.11	48.90	52.00	55.30	58.40
	Max	30.58	35.30	38.50	41.65	44.85	49.60	52.75	55.94	59.10
L1	Min	23.12	23.12	23.12	23.12	23.12	23.12	23.12	23.12	23.12
	Max	23.36	23.36	23.36	23.36	23.36	23.36	23.36	23.36	23.36
L2	Min	8.18	8.18	8.18	8.18	8.18	8.18	8.18	8.18	8.18
	Max	8.32	8.32	8.32	8.32	8.32	8.32	8.32	8.32	8.32
L3	Min	2.60	2.60	2.60	2.60	2.60	3.35	3.35	3.35	3.35
	Max	3.00	3.00	3.00	3.00	3.00	3.79	3.79	3.79	3.79
d	0/-0.25	17.78	20.96	25.65	28.83	32.00	35.18	38.35	41.53	44.70
p	0/-0.25	17.02	18.58	24.26	27.56	30.73	33.91	37.08	40.26	43.45

* Detail A see page 27

8LT Connectors



Square flange receptacle type 2

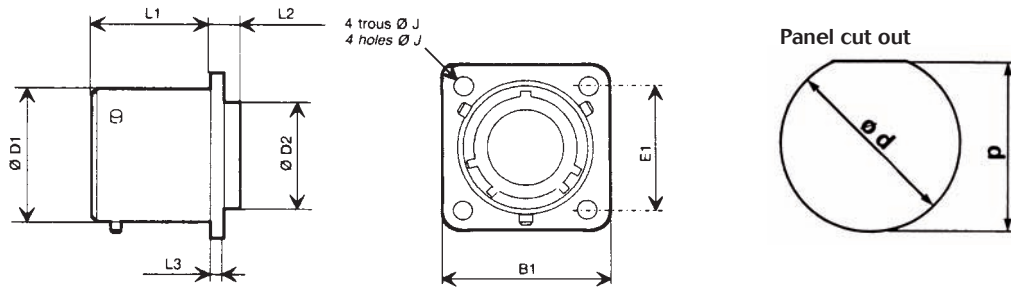

Shell size		09	11	13	15	17	19	21	23	25
B1	Min	23.70	26.05	28.50	30.85	33.20	36.40	39.55	42.75	46.00
	Max	24.30	26.70	29.05	31.45	33.80	37.00	40.15	43.35	46.50
E1		18.26	20.62	23.01	24.61	26.97	29.36	31.75	34.93	38.10
D1	Min	14.40	17.65	21.40	24.65	27.82	29.24	33.70	36.92	40.06
	Max	14.53	17.78	21.59	24.77	27.94	30.66	33.83	37.00	40.18
D2	Min	9.85	12.80	16.00	18.95	22.10	25.10	28.25	31.40	34.60
	Max	9.95	12.90	16.10	19.05	22.20	25.20	28.35	31.50	34.70
J	Min	3.25	3.25	3.25	3.25	3.25	3.25	3.25	3.73	3.73
	Max	3.35	3.35	3.35	3.35	3.35	3.35	3.35	3.83	3.83
L1	Min	20.71	20.71	20.71	20.71	20.71	20.71	19.96	19.96	19.96
	Max	20.83	20.83	20.83	20.83	20.83	20.83	20.08	20.08	20.08
L2	Min	5.40	5.40	5.40	5.40	5.40	5.40	6.15	6.15	6.15
	Max	5.55	5.55	5.55	5.55	5.55	5.55	6.35	6.35	6.35
L3	Min	2.14	2.14	2.14	2.14	2.14	2.14	2.90	2.90	2.90
	Max	2.54	2.54	2.54	2.54	2.54	2.54	3.30	3.30	3.30
d	Min	16.66	20.22	23.42	26.59	30.96	32.94	36.12	39.29	42.47
J1	± 0.15	3.25	3.25	3.25	3.25	3.25	3.25	3.25	3.91	3.91
e		18.26	20.62	23.01	24.61	26.97	29.36	31.75	34.92	38.10

Plug type 5 & type 15

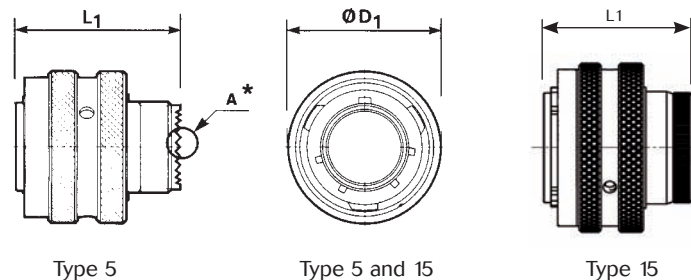

Shell size		09	11	13	15	17	19	21	23	25
D1	Min	14.35	17.70	21.50	24.65	27.85	30.55	33.75	36.90	40.10
	Max	21.80	25.00	29.30	32.50	35.70	38.50	41.70	43.85	48.00
L1	Min	31.28	31.28	31.28	31.28	31.28	31.28	31.28	31.28	31.28
	Max	31.35	31.35	31.35	31.35	31.35	31.35	31.35	31.35	31.35

* Detail A see page 27

Dimensions in millimeters

8LT Connectors



Receptacle with straight spill contact

receptacle type 7

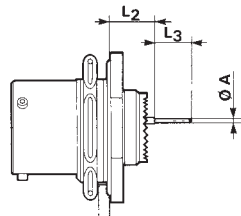

receptacle type 0

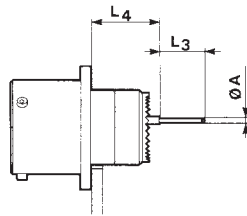

receptacle type 3

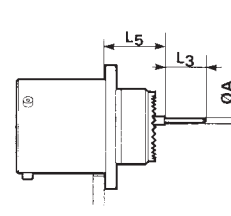

Shell Size				09	11	13	15	17	19	21	23	25	
Ø A	Contact Size	Contact Type *	Spill Contact **										
Ø A	#22D	M & F	C & L	0.70									
			S	0.50									
	M	M	0.50										
	#20	M & F	C	0.70									
#16	M & F	C	1.15										
L3	#22D	M & F	C	4 ⁰ _{-0.20}									
			S	5 ^{±0.1}									
	M	M	8.5 ⁰ _{-0.20}										
	#20	M & F	C	5 ^{±0.1}									
#16	M & F	C	5 ^{±0.1}										
L2 type 7	8LT #22D	M	C & L	Max	10.06								
			M	Min	9.07								
		F	C & L	Max	10.21								
			M	Min	9.23								
	8LT7S HE308 #22D	M	S	Max	10.23								
				Min	9.24								
		F	S	Max	10.23								
				Min	8.91								
8LT HE308 #20 & #16	M & F	C	Max	10.23									
			Min	9.24									
L4 type 0	#22D	M	C & L	Max	15.08								
			M	Min	13.91								
		F	C & L	Max	15.22								
			M	Min	14.05								
	M	S	Max	15.25	-							15.25	
			Min	14.08	-							14.08	
	F	S	Max	15.25	-							15.25	
			Min	13.75	-							13.75	
	#20 & #16	M & F	C	Max	15.25								
				Min	14.08								
L5 type 3	#22D	M	C & L	Max	12.47				13.22				
			M	Min	11.60				12.35				
		F	C & L	Max	12.47				13.22				
			M	Min	11.27				12.02				
	M	S	Max	12.64	-			12.64	13.39				
			Min	11.77	-			11.77	12.52				
	F	S	Max	12.64	-			12.64	13.39				
			Min	11.44	-			11.44	12.19				
#20 & #16	M & F	C	Max	12.64				13.39					
			Min	11.77				12.52					

* M: Male Contact, F: Female Contact

** C: Short Spill, M: Medium Spill, L: Long Spill, S: Specific Spill

8LT Connectors



Receptacle type 7 with wire wrap contacts

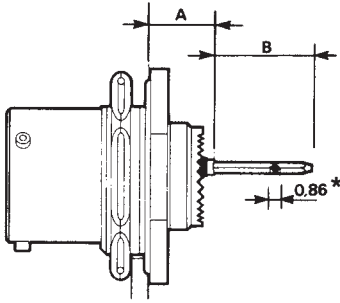

Contact size	Contact type	A	B Max
#22D	W 3 wraps	9.07 to 10.06	16.00
#20	T 2 wraps	9.7 to 10.06	12.60

* See page 35

Detail A

sealing bushing used for triaxial # 8 protude

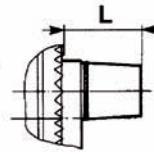

Shell Type	Type 0	Type 1	Type 3	Type 5	Type 7
L max	13.39	13.58	13.58	13.54	13.58

8LT Connectors



SOURIAU Rack and Panel connectors part numbers

Basic series	8 LT	27	-	15	B	35	P	N	-	-	L
Shell type											
27: Receptacle for rack, for male contacts, with possibility to mount rear accessory											
23: Square flange receptacle (consult us)											
26: Floating plug for rack, for crimp female contacts, with possibility to mount rear accessory											
Type											
None: Connector with standard crimp contacts											
Q: Connector with quadrax crimp contacts											
C: Connector with short spill (male and female #20, #16, #12, #8 quadrax)											
S: Connector with specific straight spill (male and female #22D only)											
L: Connector with long spill (male and female #22D)											
Shell size: 11, 13, 15, 17, 19, 21, 23, 25											
Plating											
F: Nickel B: Olive green cadmium											
Contact layout: See tables pages 14 to 19											
Contact type											
P: Male S: Female											
Polarization: N											
Specification											
None: Supplied with contacts											
251: Connector provided with power contacts (for layout with cavities #8)											
*284: Quadrax grounded (cts 100Ω)											
308: Quadrax not grounded (cts 100Ω)											
*384: Quadrax grounded (cts 150Ω)											
408: Quadrax not grounded (cts 150Ω)											
Special custom											
None: Standard plastic cap M: Antistatic plastic cap											
L: Connector supplied without contacts											

*Excepted mixed layouts with quadrax and signal contacts. Please consult us.

HE 308 Rack and Panel connectors part numbers

Basic series	HE308	26	T	23	01	P	N	7	M	-	-
Shell type											
26: Floating plug for rack, for crimp female contacts, with possibility to mount rear accessory											
27: Receptacle for rack, for male contacts, with possibility to mount rear accessory											
21: Receptacle for rack with straight spill contacts											
Class											
T: Sealed											
Shell size: 11, 13, 15, 17, 19, 21, 23											
Contact layout: See tables pages 14 to 19											
Contact type											
P: Male S: Female											
Polarization: N											
Plating											
7: Olive green cadmium											
Contractual specifications											
M: DAT quality insurance											
Special custom											
None: Standard plastic cap M: Antistatic plastic cap											
Specifications											
None: Connector supplied with contact L: Connector supplied without contact											

8LT Connectors



Rack & Panel, features and benefits

- Signal and Power connector
- Easy and fast connection without any coupling/uncoupling between a float-mounting unit and a fixed unit.
- 100% scoop proof
- Plug misalignment allowed
- Rear accessories available
- 8 shell sizes available: from 11 to 23 with DTAT-C5935-X0005 layout - including power contact cavities
- Sealing as per HE 308
- EMI performances as per DTAT-C5935-X0005

Shell Size	Mated Force (daN)	Unmated Force (daN)
11	20	12
13	30	13
15	35	15
17	50	16
19	55	18
21	65	22
23	80	27
25 *	-	-

* Please consult us

Blind mateable connector

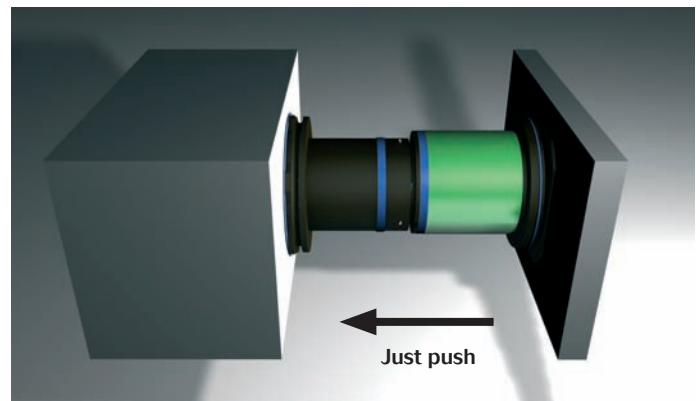

Just push to connect... and release to disconnect

Superior misalignment allowances

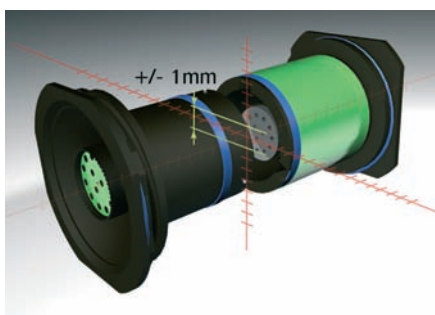

Axial alignment

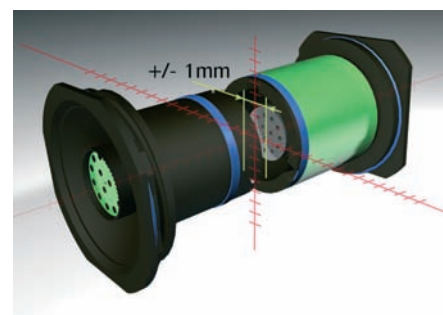

Axial alignment

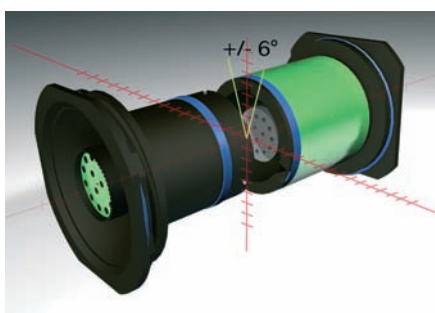

Angular alignment

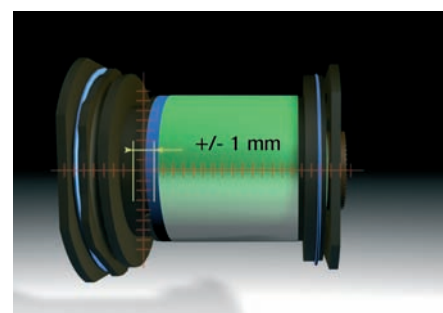

Longitudinal alignment

8LT Connectors



Rack & Panel, dimensions

Equipment receptacle (type 27)

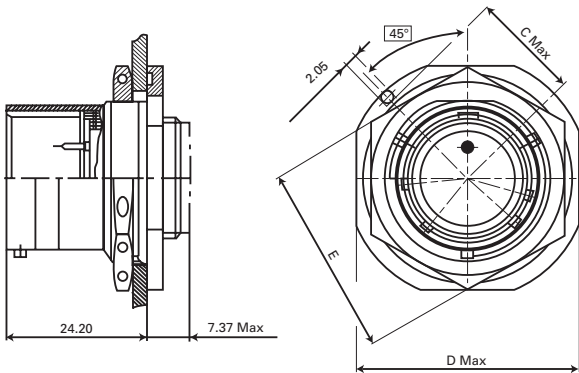

Shells	11	13	15	17	19	21	23	25
C Max	15.33	16.92	18.51	20.10	22.67	24.26	25.84	27.43
D Max	32.16	35.34	38.51	41.69	46.43	49.64	52.78	56.00
E	25.55	30.30	33.45	36.65	39.80	43	46.15	50.95

Rack plug (type 26)

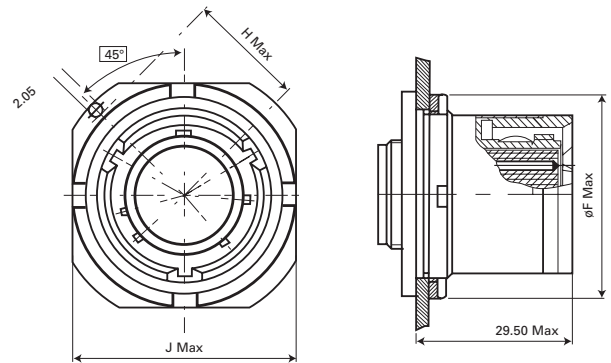

Shells	11	13	15	17	19	21	23	25
øF Max	32.10	35.25	38.40	41.60	46.30	49.60	52.70	55.90
H Max	16.92	18.51	20.10	22.67	24.26	25.84	27.43	29.03
J Max	32.16	35.34	38.51	41.69	46.43	49.64	52.78	55.96

Square flange receptacle (type 23)

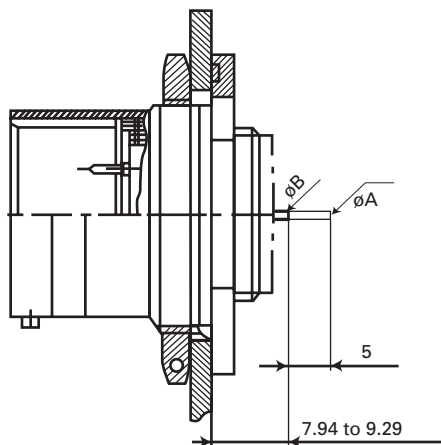

Contact size	#22D	#20	#16
A	0.5	0.7	1.15
B	1	1.5	2.2

Mated connectors plug (type 26) and receptacle (type 27)

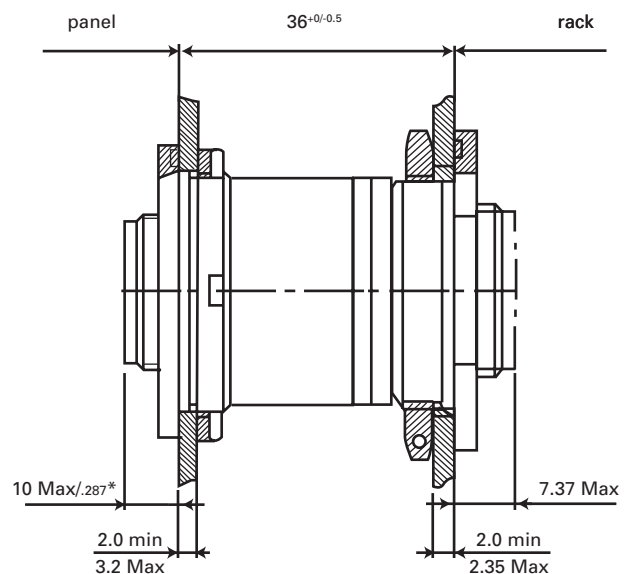

*Included longitudinal alignment

8LT Connectors



Rack & Panel, panel cut

Plug panel cut

Shell size	Plug			
	W	Ø X °	K mini	Ø A
11	12.81	25.58	32.57	Ø 2 ^{-0.05}
13	13.94	28.80	36	
15	15.06	31.98	39.60	
17	16.88	35.15	43.30	
19	18	38.28	47	
21	19.12	41.50	50.60	
23	20.24	44.68	54.20	
25 *	-	-	-	

Receptacle panel cut

Shell size	Plug			
	W	Ø X °	K mini	Ø A
11	12.81	25.58	32.57	Ø 2 ^{-0.05}
13	13.94	28.80	36	
15	15.06	31.98	39.60	
17	16.88	35.15	43.30	
19	18	38.28	47	
21	19.12	41.50	50.60	
23	20.24	44.68	54.20	
25 *	-	-	-	

* Please consult us

8LT Connectors



Crimp contacts

Contact size	Contact type	SOURIAU P / N (No colour code)	Contacts	
			QPL Part Numbers	Profile and colour code
#22D	Pin	8599-0702 JJ	M39029/58 360	orange bleu - blue noir - black
	Socket	8599-0706 900	M39029/56 348	orange jaune - yellow gris - grey
#20	Pin	8599-0703 SA	M39029/58 363	orange bleu - blue orange
	Socket	8599-0707 900	M39029/56 351	orange vert - green marron - brown
#16	Pin	8599-0704 MJ	M39029/58 364	orange bleu - blue jaune - yellow
	Socket	8599-0708 900	M3929/56 352	orange vert - green rouge - red
#16 Coaxial	Pin	N/A	M39029/76-424	-
	Socket	N/A	M39029/77-428	-
#12	Pin	8599-0705 MJ	M39029/58 365	orange bleu - blue vert - green
	Socket	8599-0709 900	M39029/56 353	orange vert - green orange
#8 Power*	Pin	8599-7544	N/A	-
	Socket	8599-7541	N/A	-
#8 Coaxial	Pin	N/A	M39029/60 367	
	Socket	N/A	M39029/59 366	-
#8 Triaxial	Pin	N/A	M39029/90 529	
		8599-5210 900 included boot 85994571	N/A	
#8 Triaxial	Socket	N/A	M39029/91 530	
		8599-5220 900 included boot 85994571	N/A	
#4 Power*	Pin	8599-7598 900**	N/A	For cable 25 mm ²
	Socket	8599-7599 900**	N/A	
	Pin	8599-7534	N/A	For cable 21,15 mm ²
	Socket	8599-7535	N/A	
#4 Power with reduced barrel	Pin	8599-7528 900	N/A	For cable #6
	Socket	8599-7529 900	N/A	

* Boots & reducers see page 34.

** Not included in connector P / N. Must be ordered separately.

8LT Connectors



Technical characteristics

Contact size	Contact type	Contact \varnothing	admissible wire section				External \varnothing over insulation mm	
			AWG		mm ²			
			min	max	min	max		
#22D	Pin	0.76	28	22	0.095	0.34	0.76	1.37
	Socket							
#20	Pin	1	24	20	0.21	0.60	1.02	2.11
	Socket							
#16	Pin	1.60	20	16	0.60	1.34	1.65	2.77
	Socket							
#16 Coaxial	Mâle/Pin	1.60	RG 174 RG 179 RG 316				1.65	2.60
	Socket							
#12	Pin	2.40	14	12	1.91	3.18	2.46	3.61
	Socket							
#8 Power*	Pin	3.64		8		8.98	4.50	6.50
	Socket							
	Boot							
#8 Coaxial	Pin	3.64	RG 188 A/U				2.80	
	Socket							
#8 Triaxial	Pin	5.5	MIL C 17/176.00002 FILECA F 2703/14 RAYCHEM CHEMINAX 106 12 FILOTEX M 17/176.00002				3.15	3.40
	Socket							
#4 Power*	Pin 8599-7598 900	5.74	-	(3)	-	25	-	-
	Socket 8599-7599 900							
	Pin 8599-7534							
	Socket 8599-7535							
#4 Power with reduced barrel	Pin	5.74	-	6	-	13.3	-	
	Socket							

* Boots & reducers see page 34.

8LT Connectors



Reducers

Reductor Size	Part number	For cable	For contacts
#8 Power	8599-7645	#10	8599-7544 (Pin) 8599-7541 (Socket)
#4 Power	8400-2352A	10 mm ²	8599-7534A (Pin) 8599-7535A (Socket)

Boots

Boot Size	Part number	Admissible wire section mm ²		For cable
#8 Power	8599-4542	5	6.5	8.48 à 10 mm ²
	8599-4547	2.5	4	#10
#4 Power	8599-4594	6.35	7.5	#4 - #5
	8599-4593	4	5.8	#6 - #8



Straight spill contacts

Contact size	Contact type	Spill Type	Part Numbers	Profile
#22D 8LT	Male	L	8599-0720 900	
	Male	C	8599-0730 900	
	Female	L	8599-0721 900	
	Female	C	8599-0731 900	
	Male	M	8599-8028 900	-
#22D HE 308	Male	S	8599-0796 900	
	Female	S	8599-0797 900	
#20	Male	C	8599-0724 900	
	Female	C	8599-0725 900	
#16	Male	C	8599-0726 900	
	Female	C	8599-0727 900	
#12	Male	C	8599-7929 900	-
	Female	C	8599-7932 900	-







8LT Connectors

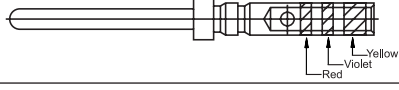

Wire wrap contacts

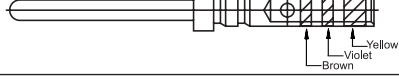
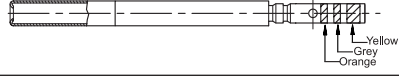
Contact size	Contact type	Part Numbers	Profile	Contact \varnothing mm	
#22D	Male	8599.0790 JJ		0.76	0.86
#20	Male	8599.0791 900		1	0.86

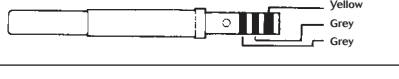
Thermocouple contacts

Contact size Contact type	Contact type	Souriau part numbers	Contacts MIL DTL 38999	
			Part Numbers	Profile and color code
#22D Chromel	Male Pin	N / A	M39029/87-472	
	Female Socket	N / A	M39029/88-484	
#22D Alumel	Male Pin	N / A	M39029/87-471	
	Female Socket	N / A	M39029/88-483	
#20 Chromel	Male	8599-0749 900	8599-0949 900	
	Female	8599-0753 900	8599-0953 900	
#20 Alumel	Male	8599-0761 900	8599-0961 900	
	Female	8599-0765 900	8599-0965 900	

Technical characteristics

Contact size	cts \varnothing (mm)	Wire section				\varnothing over insulation (mm)	
		AWG		mm ²		Min	Max
		Min	Max	Min	Max		
#22D Chromel Alumel	0.76	28	22	0.095	0.34	0.76	1.37
#20 Chromel Alumel	1	24	20	0.21	0.6	1.02	2.11

8LT Connectors



Quadrax contacts #8

Part Number	Version	Contact type	Impedance
ETH1-1235A	Crimp	Pin	100Ω
ETH1-1503A	Crimp	Pin	150Ω
ETH1-1236A	Crimp	Socket	100Ω
ETH1-1504A			150Ω
ETH1-1237A	PCB mount	Pin	100Ω
ETH1-1501A			150Ω
ETH1-1238A	PCB mount	Socket	100Ω
ETH1-1502A			150Ω

8LT Connectors



Orientations

Polarization is determined by the master keyway position.
The secondary keyway positions remain fixed.

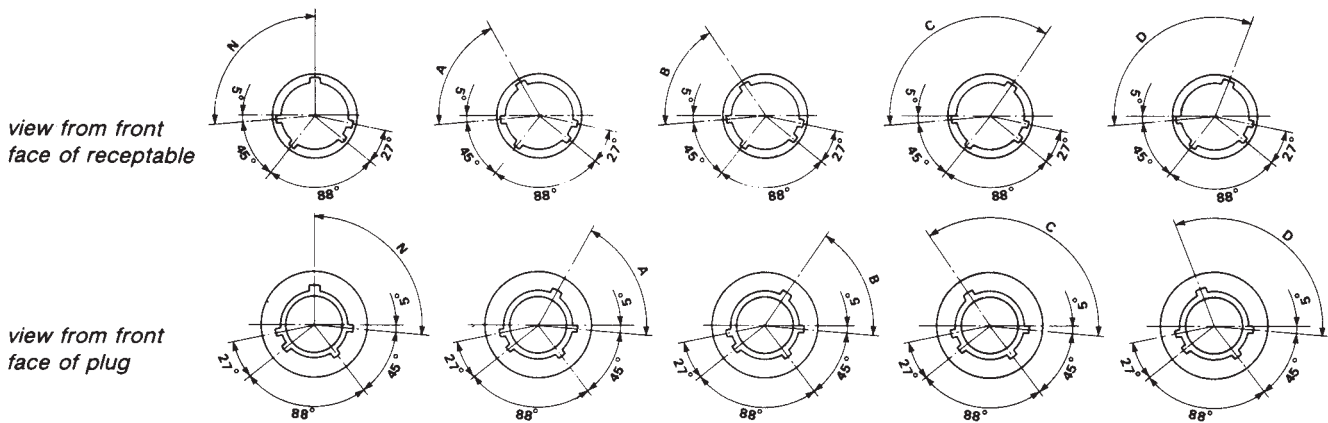

Shell size	Angles (degrees)				
	N	A	B	C	D
09	95	77	-	-	113
11	95	81	67	123	109
13	95	75	63	127	115
15	95	74	61	129	116
17	95	77	65	125	113
19	95	77	65	125	113
21	95	77	65	125	113
23	95	80	69	121	110
25	95	80	69	121	110

8LT Connectors



Accessories

Protective cap for receptacles

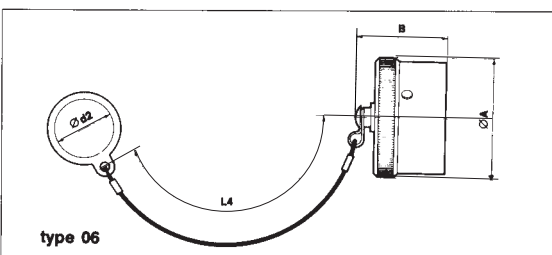
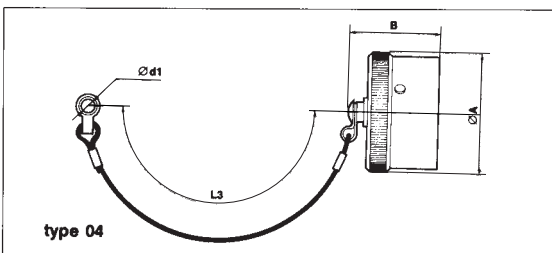
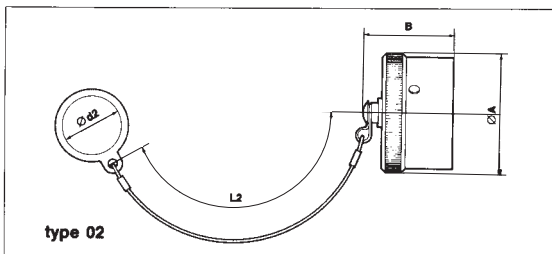
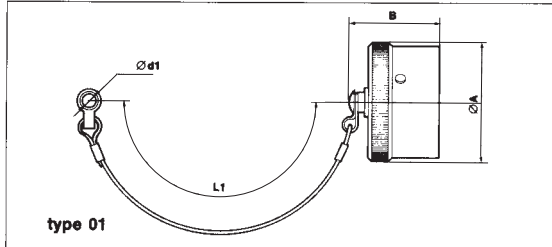

Protective cap for plugs

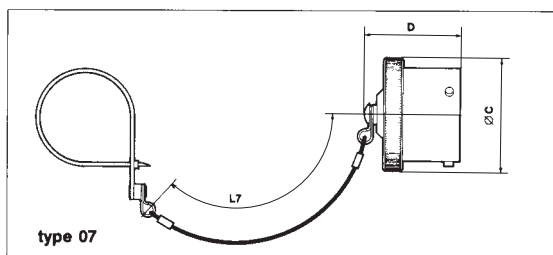
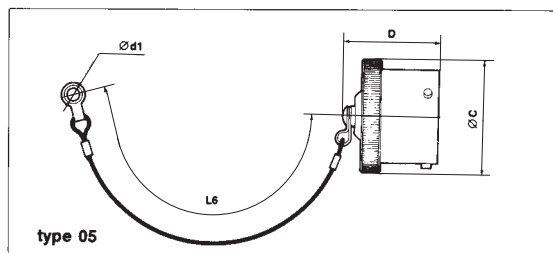
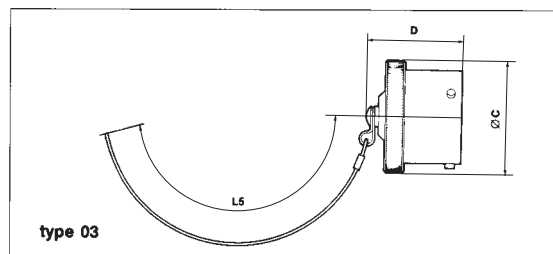
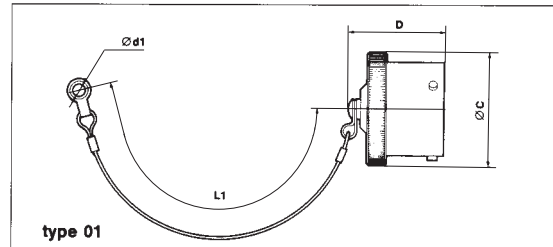

Shell size	A Max	B Max	C Max	D Max	d1 min	d2 min	L1	L2	L3±5	L4±5	L5±5	L6±5	L7±5
09	21.80	28.00	20.80	29.50	3.20	17.80	76	76	105	105	200	160	160
11	24.90	28.00	23.80	29.50	3.20	21.30	76	76	105	105	200	160	160
13	29.40	28.00	27.70	29.50	3.20	25.70	89	89	105	105	200	160	160
15	32.50	28.00	30.20	29.50	3.20	29.00	89	89	105	105	200	160	160
17	35.80	28.00	33.50	29.50	3.20	32.00	89	89	105	105	200	160	160
19	38.60	28.00	36.50	29.50	3.20	35.30	89	89	105	105	200	160	160
21	41.90	28.00	39.80	29.50	3.20	38.40	102	102	105	105	200	160	160
23	44.90	28.00	42.90	29.50	3.20	41.70	102	102	105	105	200	160	160
25	48.00	28.00	46.20	29.50	3.20	44.70	102	102	105	105	200	160	160

8LT Connectors



Protective caps

Basic series	8LT	E	01	B	13
Cap type					
E: Cap for receptacle					
F: Cap for plug					
Fixing type					
Cap for receptacle			Cap for plug		
01: Plastic sleeved metal card with eyelet			01: Plastic sleeved metal card with eyelet		
02: Plastic sleeved metal card with ring			03: Nylon cord without fastener		
04: Nylon cord with eyelet			05: Nylon cord with eyelet		
06: Nylon cord with ring			07: Nylon cord with strap		
10: Black nylon cord with eyelet					
Plating					
B: Olive green cadmium					
F: Nickel					
Shell size: 09 - 11 - 13 - 15 - 17 - 19 - 21 - 23 - 25					

Dummy receptacle

Shell size	Part numbers	L1 Max	L3 Max	D1 Max	B1 Max	E1	J
09	8LT0-09GUR	16.05	2.54	14.53	24.25	18.26	3.25
11	8LT0-11GUR	16.05	2.54	17.78	26.60	20.62	3.25
13	8LT0-13GUR	16.05	2.54	21.59	29.00	23.01	3.25
15	8LT0615GUR	16.05	2.54	24.77	31.35	24.61	3.25
17	8LT0-17GUR	16.05	2.54	27.94	33.75	26.97	3.25
19	8LT0-19GUR	16.05	2.54	30.66	36.90	29.36	3.25
21	8LT0-21GUR	15.29	3.30	33.83	40.10	31.75	3.25
23	8LT0-23GUR	15.29	3.30	37.00	43.25	34.93	3.73
25	8LT0-25GUR	15.29	3.30	40.18	46.50	38.10	3.73

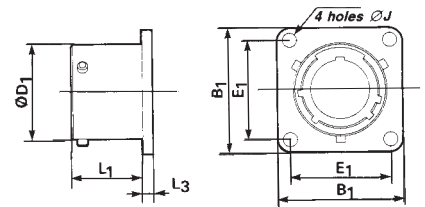

Plastic protective caps

Shell size	Part numbers for standard cap	
	Caps for receptacle	Caps for plug
09	8500-5594	70609
11	MS90376-12R	MS90376-16Y
13	8500-5588A	8500-5600
15	8500-5589A	8500-5601
17	MS90376-20YF	8500-5602
19	8500-5601	8500-5592A
21	8500-5602	8500-5593A
23	MS90376-24R	MS90376-24R
25	8500-5593A	J599ABC6009A00

Shell size	Part numbers for antistatic cap	
	Caps for receptacle	Caps for plug
09	MS90376-10RF	MS90376-14RF
11	MS90376-12RF	MS90376-16RF
13	8500-5588N	8500-5600N
15	MS90376-18YF	8500-5601N
17	MS90376-20YF	8500-5602N
19	8500-5601N	8500-5592N
21	8500-5602N	8500-5593N
23	MS90376-24RF	-
25	8500-5593N	-

8LT Connectors



Panel gasket

Shell size	Part numbers	
	Gasket for receptacle type 0, 2, 3 (to be ordered separately)	O ring for receptacle type 7 (shipped with connector)
09	8599-5541	AS3582-019
11	8599-5542	AS3582-022
13	8599-5543	AS3582-024
15	8599-5544	AS3582-026
17	8599-5545	AS3582-028
19	8599-5546	AS3582-128
21	8599-5547	AS3582-130
23	8599-5548	AS3582-132
25	8599-5549	AS3582-134

Tooling

Crimping (#22D, #20, #16 and #12)

Contact size	Wire sizes		Type	Pliers						
				M22520/1-01 (Souriau 8365)		M22520/2-01 (Souriau 8476-01)		M300 BT Locator P / N	M21520/23-01	
	mm ²	AWG		P / N turret		P / N locator			P / N turret	P / N locator
			Norm/Spec	Souriau	Norm/Spec	Souriau				
#22D	0.38	22	M	-	-	M22520/2-09	8476-09	-	-	-
	0.21	24								
	0.15	26	F	-	-	M22520/2-07	8476-07	-	-	-
	0.095	28								
#20	0.60	20	M	M22520/1-04	8365-04	M22520/2-10	8476-10	-	-	-
	0.38	22								
	0.21	24	F	M22520/1-04	8365-04	M22520/2-10	8476-10	-	-	-
#16	1.34	16	M	M22520/1-04	8365-04	-	-	-	-	-
	0.93	18								
	0.60	20	F	M22520/1-04	8365-04	-	-	-	-	-
#12	3.18	12	M	M22520/1-04	8365-04	-	-	-	-	-
	1.91	14	F	M22520/1-04	8365-04	-	-	-	-	-
#8 power	8.98	8	M	-	-	-	-	SP 593	M22520/23-02	8599-9601
	max	max	F	-	-	-	-			
#4 power*	10	7	M	-	-	-	-		M22520/23-04	M22520/23-11
	16	4	F	-	-	-	-			

* Pneumatic pliers

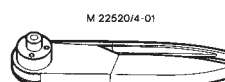
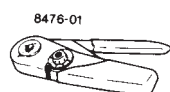
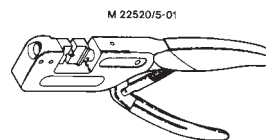
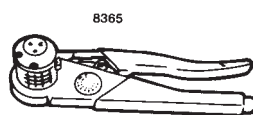

8LT Connectors



Coaxial contact #16

Contat type	Pliers	Locators
Inner contact	M22520/2-01	M22520/2-35
Outer contact	M22520/4-01	M22520/4-02

Triaxial contact #8

Contat type	Pliers	Locators
Middle contact	M22520/5-01	Y 631 closure B
Inner contact	M22520/2-01	K 709
Ferrule	M22520/5-01	Y 631 closure A

Quadrax contact #8

Outer body: M2252015-01 crimping tool and M2252015-45 dieset rep B
 Signal contact: M22520/201 crimping tool and K709 positioner

Dummy contact #8

Part number
8599-0308



Dummy contact #4

Part number
8599-0310

Filler plugs

Contact size	Part Numbers		Colour
	Spec	Souriau	
#22D	MS27488-22	8660-212	Black
#20	MS27488-20	8522-389A	Red
#16	MS27488-16	8522-390A	Blue
#12	MS27488-12	8522-391A	Yellow



Direction of introduction
in grommet

Insertion and extraction of wired contacts

Contact size	Material	Part Numbers		Colour	
		Spec	Souriau	Insertion	Extraction
#22D	Plastic	M81969/14-01	8599-0022	Green	White
#20	Pastic	M81969/14-10	8522-20	Red	Orange
#16	Plastic	M81969/14-03	8522-16	Blue	White
#12	Plastic	M81969/14-04	8522-12	Yellow	White
#10	Plastic	M81969/14-05	-	Grey	White
#8	Metallic	-	8660-197	manual insertion	No colour
	Plastic	M81969/14-12	-		Red
#4	Metallic	-	8533-8175	-	No colour
	Plastic	M81969/14-07	-		Blue



Colored tip for insertion
White tip for extraction

8660-197



8LT Connectors



Wiring instructions

Cable preparation and wire stripping

Contact size	L (mm)
#22D	4
#20	6
#16	
#12	
#8	12
#4	



Insertion of wire in contact barrel

When inserting the stripped wire into the contact barrel check that no strands are left outside and that the wire is visible through the wire inspection hole in the barrel.

Important :

- Slide any accessories over wire strands before carrying out the following operations.
- Contacts are inserted and extracted from the rear of the connector.

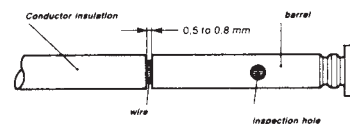

Insertion of the contacts

1 - Engage the grimp cable / contact assembly into the longitudinal slot of the plastic tool (coloured tip).
Slide the tool down the cable until the tip of the tool abuts the contact retention shoulder.

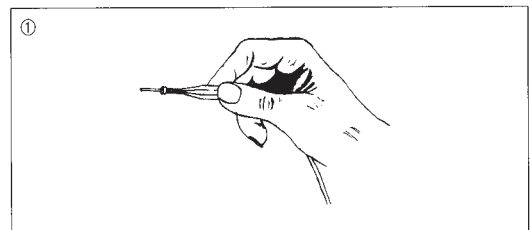

2 - Introduce the contact into the required contact cavity in the insulator, pushing tool axially, until the contact snaps into position in clip.

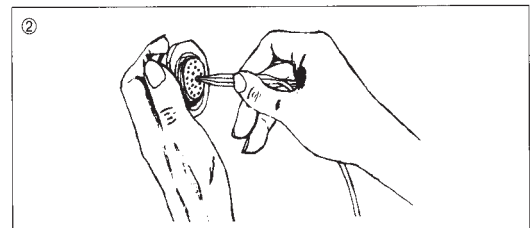

3 - Withdraw the tool (from rear). Check that contact is firmly locked by pulling wire gently.
When connector is fully loaded, check the position of contact tips. They should all be in the same plane.

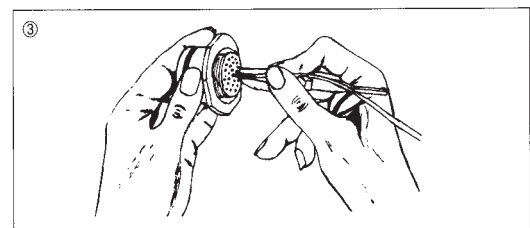

Nota : For larger sizes of cable which are stiff enough manual insertion without tool is preferable.

8LT Connectors



Extraction of the contacts

1 - Engage the appropriate cable into the longitudinal slot of the tool with the white tip towards connector.

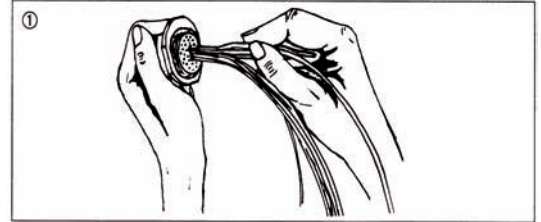

2 - Slide the tool down towards the contact. Insert the tool in the insulator until it abuts the contact shoulder.

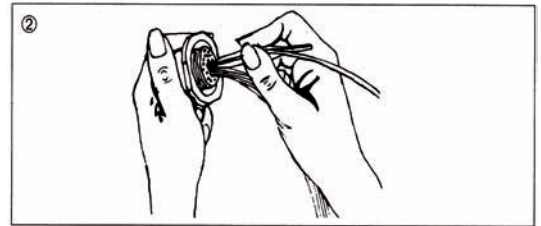

3 - Holding the tool-contact and cable assembly together, remove them simultaneously.

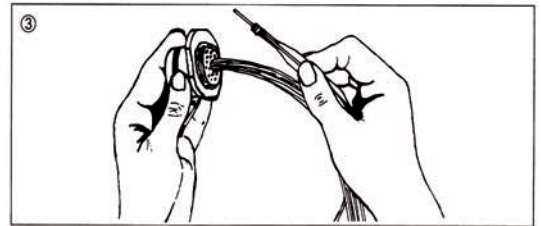

Tightening support

Part number
8599-0801

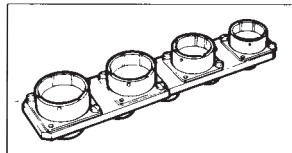

Backshell tightening and slackening tools

Backshell tightening pliers, part number : 8498-03

Square jaws, part number : 8500-1015 (order 2 jaws)

Strap clamp : 8498-04

Spare strap : 8498-103

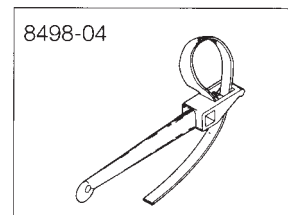
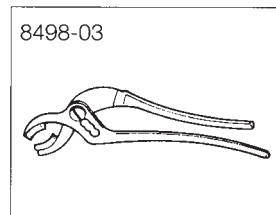

Tightening of fixing nuts, receptacle type 7

Shell size	09	11	13	15	17	19	21	23	25
Nut dimension across flats	22.35	25.55	30.30	33.45	36.65	39.80	43.00	46.10	50.95
Max tightening torque on nut (mN)	6	8	10	13	20	23	25	26	28

Tightening of rear accessories

Shell size	09	11	13	15	17	19	21	23	25
Max torque in m/daN	0.62						1.24		

8LT Connectors



Backshells

Basic type										8 LST	103	B	01	-
Shell size	09	11	13	15	17	19	21	23	25					
Index number	101	102	103	104	105	106	107	108	109					
Plating														
F: Nickel														
B: Olive green cadmium (MIL C 38999)														
Backshell type														
01: Backnut														
02: Straight cable clamp														
03: Elbow cable clamp														
07: Backshell for screen termination and heatshrink sleeving														
Suffix														
1: For backshell type 07 only - For receptacle type 0 (shells 09 to 25) and for plug type 5 (shells 09 to 23)														
None: For all other backshells														

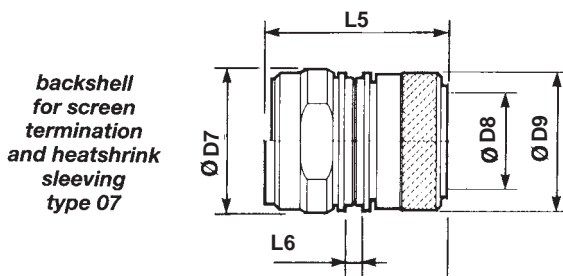

Shell size		09	11	13	15	17	19	21	23	25
D7 Max		20.20	23.20	26.20	29.20	32.20	35.20	39.20	42.20	45.20
D8	Min	6.90	9.60	12.70	14.80	17.90	19.90	23.10	26.20	28.80
	Max	7.00	9.70	12.80	14.90	18.00	20.00	23.20	26.30	28.90
D9 Max		16.00	18.90	22.10	25.30	28.50	31.50	34.70	37.90	41.00
L5 for receptacle type 0 - 3 - 1	T1	27.80	27.80	27.80	29.80	29.80	30.80	34.60	34.60	34.60
L5 Max for plug type 5	T1	27.80	27.80	27.80	29.80	29.80	30.80	34.60	34.60	-
L6 Max		3.40	3.40	3.40	3.40	3.40	3.40	3.40	3.40	3.40

8LT Connectors

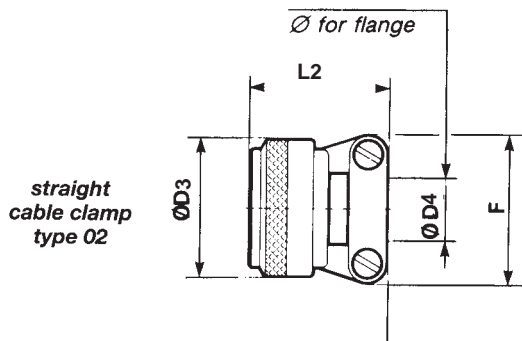
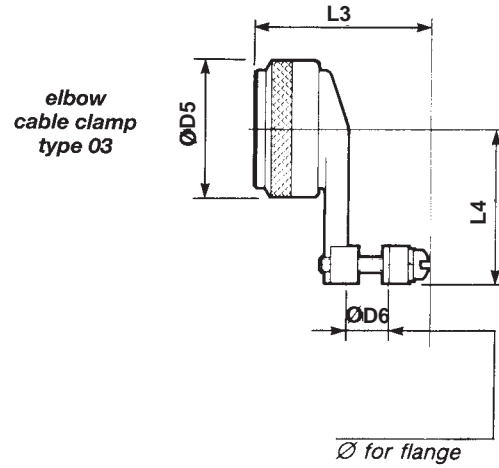
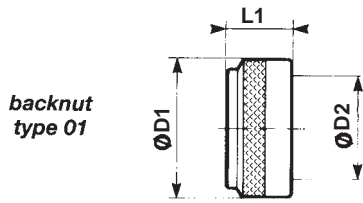

Shell size		09	11	13	15	17	19	21	23	25
D1 Max		15.67	18.64	21.79	24.99	28.24	30.94	34.16	37.29	40.46
D2 Max		6.96	10.46	13.36	16.53	19.71	22.40	25.56	28.75	31.93
L1 Max		11.30	11.30	11.30	11.30	11.30	11.30	11.30	11.30	11.30
D3 Max		15.67	18.64	21.79	24.99	28.24	30.94	34.16	37.29	40.46
D4	Min	1.40	1.40	2.40	5.60	5.60	8.80	11.90	15.10	15.10
	Max	3.20	4.80	6.40	9.50	12.70	15.90	19.10	22.20	25.40
F Max		21.03	22.63	25.81	28.98	30.56	37.31	37.31	42.06	44.45
L2 Max		22.22	22.22	22.22	28.57	28.57	28.57	28.57	31.75	31.75
L5 Max		47.22	48.02	49.52	55.92	59.42	59.42	59.42	59.42	59.42
D5 Max		15.67	18.64	21.79	24.99	28.24	30.94	34.16	37.29	40.46
D 6	Max	3.20	4.00	4.80	5.50	6.40	7.90	9.50	10.30	14.30
	Min	6.40	9.50	11.10	14.30	15.90	19.10	22.20	23.80	25.40
L3 Max		35.32	35.32	37.30	41.67	46.04	46.45	48.43	51.98	54.78
L4 Max		25.40	26.19	27.79	30.96	32.54	34.14	34.93	36.53	43.66

8LT Connectors



Cost effective & light hermetics / Resin sealed

Presentation

- Potted receptacle with male or female straight spill contacts
- 100% scoop proof: no perturbation when locking the connector, contacts never touch each other

Characteristics

- Weight saving compared to hermetic version
- Reinforced sealing for harsh environment ($10E^{-7}$ atm.cm³/s)

Comparison between standard and hermetic version

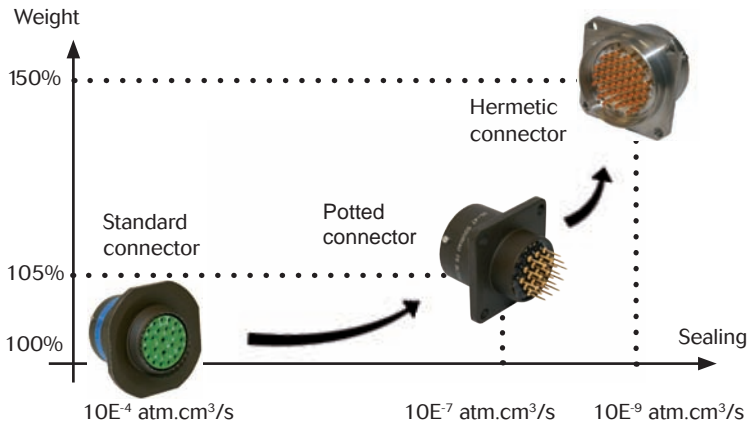

- Good shock resistance - better than hermetic glass seal
- Female contacts available for the receptacle

Contact layout

- Straight spill from #22D to #16
for all other contacts please consult us.

8LT Connectors



Souriau Part Numbers

Basic Series	8LTR	0	C	09	B	35	P	N
Shell style								
0: Square flange receptacle								
1: cable connecting receptacle								
2: Short square flange receptacle not accepting backshell								
3: Square flange receptacle (rear mounting)								
5: Plug with RFI shielding								
15 : Plug with RFI shielding not accepting backshell								
7: Jam nut receptacle								
Style								
C: Receptacle with short spill (male and female #22D, #20, #16)								
L: Connector with long spill (male and female #22D)								
S: Connector with specific straight spill (male and female #22D)								
M: Connector with average spill (male #22D)								
Shell size: 09 - 11 - 13 - 15 - 17 - 19 - 21 - 23 - 25								
Plating								
B: Olive green cadmium								
F: Nickel								
Z: Green zinc cobalt								
L: Black zinc nickel								
Contact layouts: see tables pages 14 to 19								
Contact type								
P: Male								
S: Female								
Orientation (1)								
N - A - B - C - D see table page 37								

(1) Orientation B & C not developed for shell size number 9

8LT Connectors



Coordinate for straight spill terminations Contact identification - front face view of male insulator

Holes sizes : 1 mm min (#22 and #20 contacts) and 1.3 mm min (#16 contact) coordinates in mm.

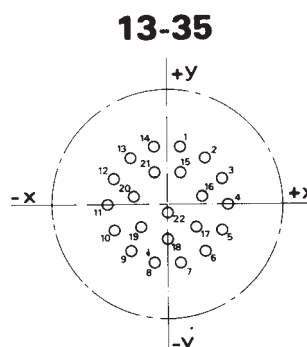
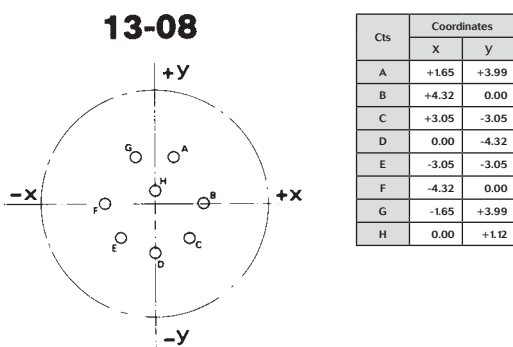
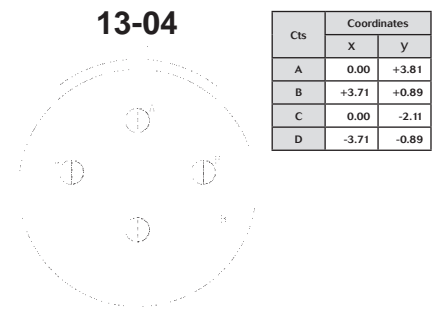
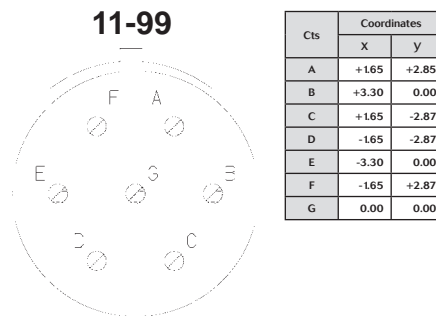
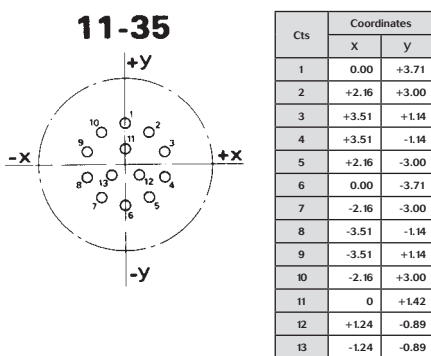
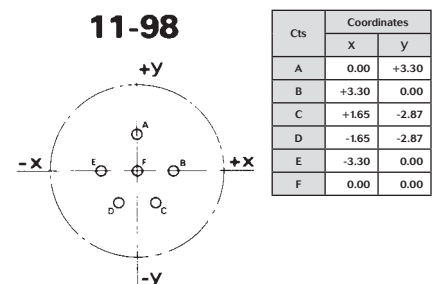
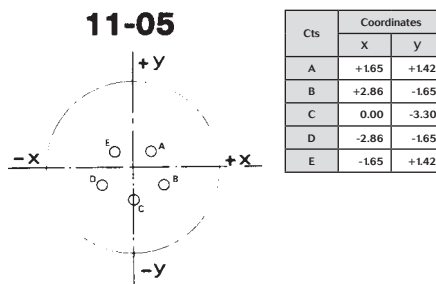
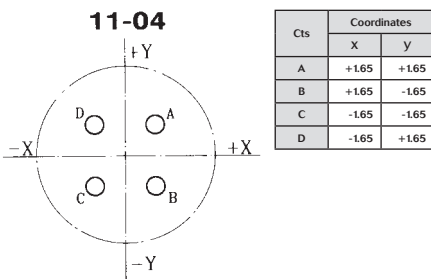
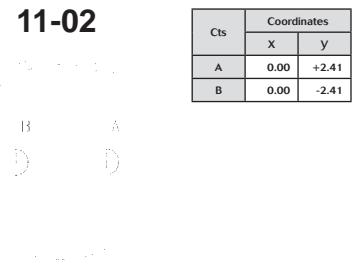
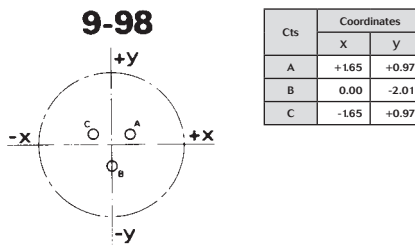
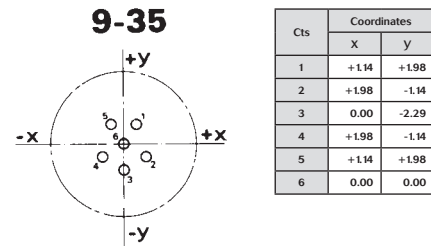

8LT Connectors



13-98

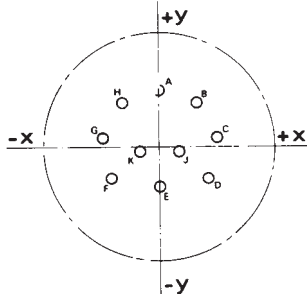

Cts	Coordinates	
	X	y
A	0.00	+4.95
B	+3.18	+3.81
C	+4.90	+0.76
D	+4.17	-2.67
E	0.00	-3.43
F	-4.17	-2.67
G	-4.90	+0.76
H	-3.18	+3.81
J	+1.65	-0.38
K	-1.65	-0.38

15-05

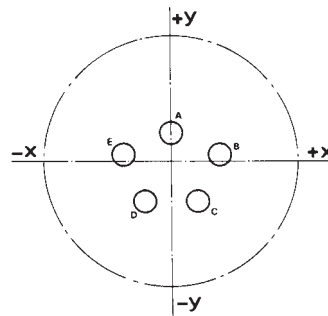

Cts	Coordinates	
	X	y
A	0	+2.54
B	+4.42	+0.61
C	+2.39	+3.76
D	-2.39	-3.76
E	-4.42	+0.61

15-18

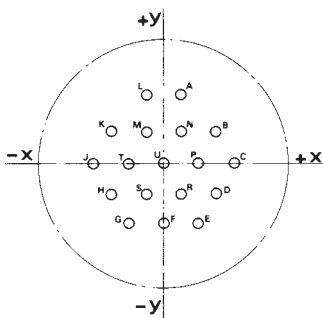

Cts	Coordinates		Cts	Coordinates	
	X	y		X	y
A	+1.65	+6.40	K	-4.95	+2.87
B	+4.95	+2.87	L	-1.65	+6.40
C	+6.60	0.00	M	-1.65	+2.87
D	+4.95	-2.87	N	+1.65	+2.87
E	+3.30	-5.72	P	+3.30	0.00
F	0.00	-5.72	R	+1.65	-2.87
G	-3.30	-5.72	S	-1.65	-2.87
H	-4.95	-2.87	T	-3.30	0.00
J	-6.60	0.00	U	0.00	0.00

15-19

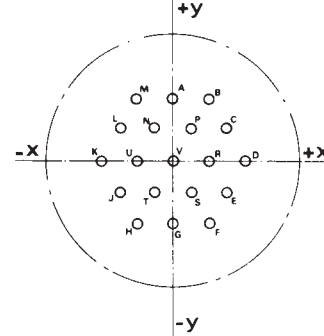

Cts	Coordinates		Cts	Coordinates	
	X	y		X	y
A	0.00	+5.72	L	-4.95	+2.87
B	+3.30	+5.72	M	-3.30	+5.72
C	+4.95	+2.87	N	-1.65	+2.87
D	+6.60	0.00	P	+1.65	+2.87
E	+4.95	-2.87	R	+3.30	0.00
F	+3.30	-5.72	D	+1.65	-2.87
G	0.00	-5.72	T	-1.65	-2.87
H	-3.30	-5.72	U	-3.30	0.00
J	-4.95	-2.87	V	0.00	0.00
K	-6.60	0.00			

15-35

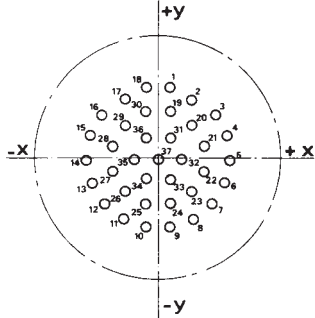

Cts	Coordinates		Cts	Coordinates	
	X	y		X	y
1	+1.14	+6.65	20	+3.12	+3.02
2	+3.12	+5.51	21	+4.32	+1.02
3	+5.36	+4.06	22	+4.32	-1.27
4	+6.45	+2.03	23	+3.12	-3.23
5	+6.75	-0.25	24	+1.14	-4.37
6	+6.27	-2.49	25	-1.14	-4.37
7	+5.08	-4.45	26	-3.12	-3.23
8	+3.30	-5.89	27	-4.32	-1.27
9	+1.14	-6.65	28	-4.32	+1.02
10	-1.14	-6.65	29	-3.12	+3.02
11	-3.30	-5.89	30	-1.14	+4.37
12	-5.08	-4.45	31	+1.14	+1.88
13	-6.27	-2.49	32	+2.29	-0.10
14	-6.76	-0.25	33	+1.14	-2.08
15	-6.45	+2.03	34	-1.14	-2.08
16	-5.36	+4.06	35	-2.29	-0.10
17	-3.12	+5.51	36	-1.14	+1.88
18	-1.14	+6.65	37	0.00	-0.10
19	+1.14	+4.37			

15-97

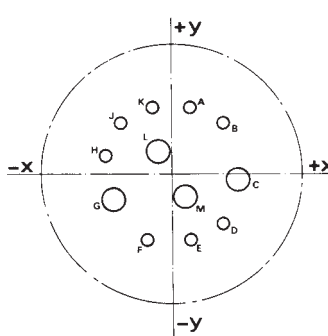

Cts	Coordinates		Cts	Coordinates	
	X	y		X	y
A	+1.65	+5.94	G	-5.26	-2.41
B	+4.52	+4.52	H	-5.94	+1.65
C	+5.84	-0.58	J	-4.52	+4.52
D	+4.52	-4.52	K	-1.65	+5.94
E	+1.65	-5.94	L	-1.19	+2.06
F	-2.26	-5.97	M	+1.19	-2.06

17-08

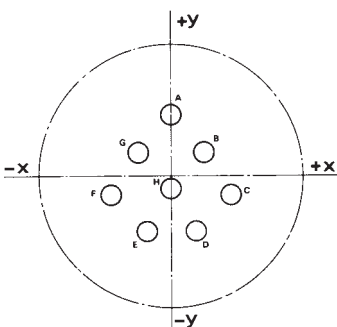

Cts	Coordinates	
	X	y
A	0.00	+5.99
B	+3.25	+2.18
C	+5.84	-1.98
D	+2.39	-5.49
E	-2.39	-5.49
F	-5.84	-1.98
G	-3.25	+2.18
H	0.00	-1.32

17-26

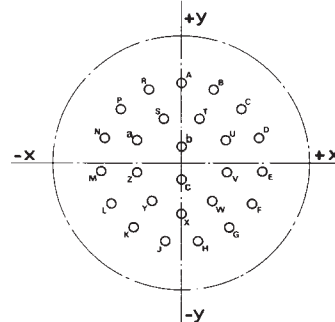

Cts	Coordinates		Cts	Coordinates	
	X	y		X	y
A	0.00	+8.15	P	-6.07	+5.44
B	+3.33	+7.44	R	-3.33	+7.44
C	+6.07	+5.44	S	-1.78	+4.50
D	+7.75	+2.51	T	+1.78	+4.50
E	+8.10	-0.86	U	+4.45	+2.39
F	+7.06	-4.09	V	+4.53	+0.91
G	+4.80	-6.60	W	+3.02	-3.84
H	+1.70	-7.98	X	0.00	-5.16
J	-1.70	-7.98	Y	-3.02	-3.84
K	-4.80	-6.60	Z	-4.53	-0.91
L	-7.06	-4.09	a	-4.45	+2.39
M	-8.10	-0.86	b	0.00	+1.65
N	-7.75	+2.51	c	0.00	-1.65

8LT Connectors



17-35

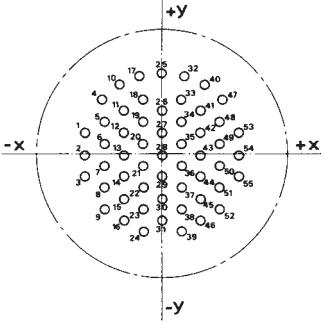

Cts	Coordinates		Cts	Coordinates		Cts	Coordinates	
	X	y		X	y		X	y
1	-7.92	+2.18	20	-1.98	+1.04	38	+1.98	-5.82
2	-7.92	-0.10	21	-1.98	-1.24	39	+1.98	-8.10
3	-7.92	-2.39	22	-1.98	-3.53	40	+4.37	+7.09
4	-6.15	+5.61	23	-1.98	-5.82	41	+3.96	+4.47
5	-5.94	+3.33	24	-1.98	-8.10	42	+3.96	+2.18
6	-5.94	+1.04	25	0.00	+8.36	43	+3.96	-0.10
7	-5.94	-1.24	26	0.00	+4.47	44	+3.96	-2.39
8	-5.94	-3.53	27	0.00	+2.18	45	+3.96	-4.67
9	-5.94	-5.82	28	0.00	-0.10	46	+3.96	-6.96
10	-4.37	+7.09	29	0.00	-2.39	47	+6.15	+5.61
11	-3.96	+4.47	30	0.00	+4.67	48	+5.94	+3.33
12	-3.96	+2.18	31	0.00	-6.96	49	+5.94	+1.04
13	-3.96	-0.10	32	+2.26	+8.03	50	+5.94	-1.24
14	-3.96	-2.39	33	+1.98	+5.61	51	+5.94	-3.53
15	-3.96	-4.67	34	+1.98	+3.33	52	+5.94	-5.82
16	-3.96	-6.96	35	+1.98	+1.04	53	+7.92	+2.18
17	-2.26	+8.03	36	+1.98	-1.24	54	+7.92	-0.10
18	-1.98	+5.61	37	+1.98	-3.53	55	+7.92	-2.39
19	-1.98	+3.33						

17-99

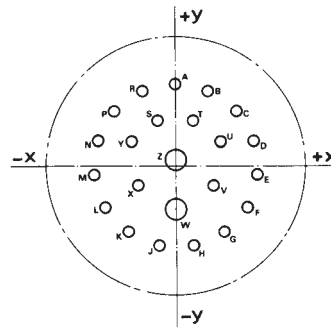

Cts	Coordinates	
	X	y
A	0.00	+8.15
B	+3.33	+7.44
C	+6.07	+5.44
D	+7.75	+2.51
E	+8.10	-0.86
F	+7.06	-4.09
G	+4.80	-6.60
H	+1.70	-7.98
J	-1.70	-7.98
K	-4.80	-6.60
L	-7.06	-4.09
M	-8.10	-0.86
N	-7.75	+2.51
P	-6.07	+5.44
R	-3.33	+7.44
S	-1.78	+4.50
T	+1.78	+4.50
U	+4.45	+2.39
V	+3.81	-1.91
W	0.00	-4.09
X	-3.81	-1.91
Y	-4.45	+2.39
Z	0.00	+0.64

19-11

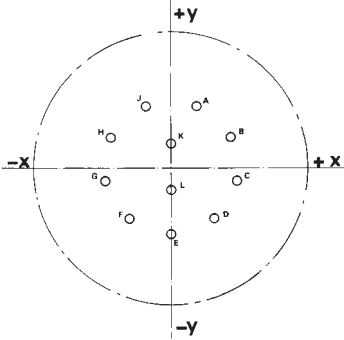

Cts	Coordinates	
	X	y
A	+2.67	+6.60
B	+6.35	+3.35
C	+6.99	-1.35
D	+4.55	-5.46
E	0.00	-7.14
F	-4.55	-5.46
G	-6.99	-1.35
H	-6.35	+3.35
J	-2.67	+6.60
K	0.00	+2.67
L	0.00	-2.34

19-32

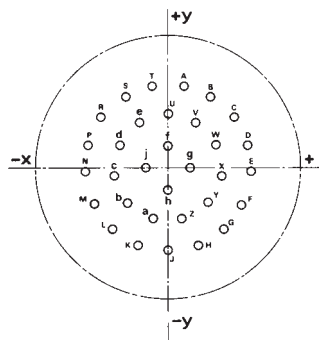

Cts	Coordinates		Cts	Coordinates	
	X	y		X	y
A	+1.68	+8.97	T	-1.68	+8.97
B	+4.80	+7.75	U	0.00	+5.84
C	+7.26	+5.51	V	+3.15	+4.90
D	+8.76	+2.49	W	+5.31	+2.41
E	+9.07	-0.84	X	+5.79	-0.84
F	+8.15	-4.06	Y	+4.42	-3.84
G	+6.15	-6.73	Z	+1.65	-5.61
H	+3.30	-8.51	a	-1.65	-5.61
J	0.00	-9.12	b	-4.42	-3.84
K	-3.30	-8.51	c	-5.79	-0.84
L	-6.15	-6.73	d	-5.31	+2.41
M	-8.15	-4.06	e	-3.15	+4.90
N	-9.07	-0.84	f	0.00	+2.44
p	-8.76	+2.49	g	+2.44	0.00
R	-7.26	+5.51	h	0.00	-2.44
S	-4.80	+7.75	j	-2.44	0.00

19-35

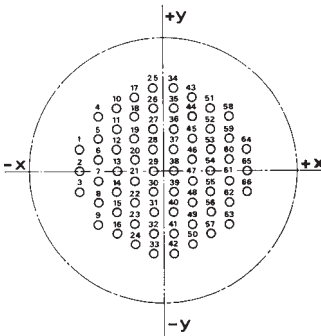

Cts	Coordinates		Cts	Coordinates		Cts	Coordinates	
	X	y		X	y		X	y
1	-9.07	+2.29	23	-3.12	-5.72	45	+3.12	+3.43
2	-9.07	+0.08	24	-3.12	-8.00	46	+3.12	+1.14
3	-9.07	-2.29	25	-1.14	+9.14	47	+3.12	-1.14
4	-7.09	+5.72	26	-1.14	+6.86	48	+3.12	-3.43
5	-7.09	+3.43	27	-1.14	+4.57	49	+3.12	-5.72
6	-7.09	+1.14	28	-1.14	+2.29	50	+3.12	-8.00
7	-7.09	-1.14	29	-1.14	0.00	51	+5.11	+6.86
8	-7.09	-3.43	30	-1.14	-2.29	52	+5.11	+4.57
9	-7.09	-5.72	31	-1.14	-4.57	53	+5.11	+2.29
10	-5.11	+6.86	32	-1.14	-6.86	54	+5.11	0.00
11	-5.11	+4.57	33	-1.14	-9.14	55	+5.11	-2.29
12	-5.11	+2.29	34	+1.14	+9.14	56	+5.11	-4.57
13	-5.11	0.00	35	+1.14	+6.86	57	+5.11	-6.86
14	-5.11	-2.29	36	+1.14	+4.57	58	+7.09	+5.72
15	-5.11	-4.57	37	+1.14	+2.29	59	+7.09	+3.43
16	-5.11	-6.86	38	+1.14	0.00	60	+7.09	+1.14
17	-3.12	+8.00	39	+1.14	-2.29	61	+7.09	-1.14
18	+3.12	+5.72	40	+1.14	-4.57	62	+7.09	-3.43
19	-3.12	+3.43	41	+1.14	-6.86	63	+7.09	-5.72
20	-3.12	+1.14	42	+1.14	-9.14	64	+9.07	+2.29
21	-3.12	-1.14	43	+3.12	+8.00	65	+9.07	0.00
22	-3.12	-3.43	44	+3.12	+5.72	66	+9.07	-2.29

21-16

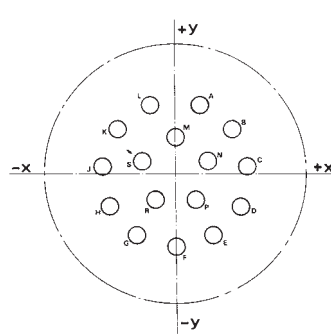

Cts	Coordinates	
	X	y
A	+3.00	+8.18
B	+6.88	+5.36
C	+8.66	+0.91
D	+7.82	-3.81
E	+4.62	-7.37
F	0.00	-8.71
G	-4.62	-7.37
H	-7.82	-3.81
J	-8.66	+0.91
K	-6.88	+5.36
L	-3.00	+8.18
M	0.00	+4.45
N	+3.91	+1.57
P	+2.39	-3.10
R	-2.39	-3.10
S	-3.91	+1.57

8LT Connectors



21-39

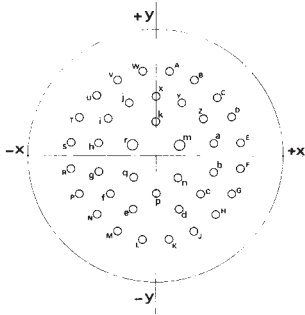

Cts	Coordinates		Cts	Coordinates		Cts	Coordinates	
	X	y		X	y		X	y
A	+1.65	+10.44	P	-9.42	-4.80	d	+2.84	-6.73
B	+4.80	+9.42	R	-10.44	-1.65	e	-2.84	-6.73
C	+7.47	+7.47	S	-10.44	+1.65	f	-5.51	-4.80
D	+9.42	+4.80	T	-9.42	+4.80	g	-7.11	-1.88
E	+10.44	+1.65	U	-7.47	+7.47	h	-7.11	+1.45
F	+10.44	-1.65	V	-4.80	+9.42	i	-5.89	+4.55
G	+9.42	-4.80	W	-1.65	+10.44	j	-3.20	+6.50
H	+7.47	-7.47	X	0.00	+7.49	k	0.00	+4.17
J	+4.80	-9.42	Y	+3.20	+6.50	m	+2.90	+1.22
K	+1.65	-10.44	Z	+5.89	+4.55	n	+2.69	-2.72
L	-1.65	-10.44	a	+7.11	+1.45	p	0.00	-4.80
M	-4.80	-9.42	b	+7.11	-1.88	q	-2.69	-2.72
N	-7.47	-7.47	c	+5.51	-4.80	r	-2.90	+1.22

21-41

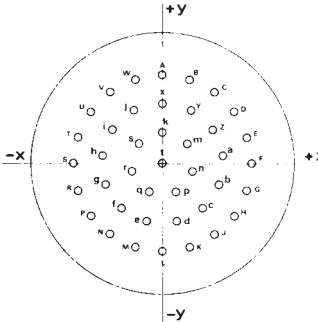

Cts	Coordinates		Cts	Coordinates		Cts	Coordinates	
	X	y		X	y		X	y
A	0.00	+10.60	R	-10.09	-3.28	f	-4.78	-5.39
B	+3.28	+10.09	S	-10.60	0.00	g	-6.73	-2.55
C	+6.23	+8.58	T	-10.09	+3.28	h	-7.15	+0.87
D	+8.58	+6.23	U	-8.58	+6.23	i	-5.92	+4.09
E	+10.09	+3.28	V	-6.23	+8.58	j	-3.35	+6.38
F	+10.60	0.00	W	-3.28	+10.09	k	0.00	+3.81
G	+10.09	-3.28	X	0.00	+7.20	m	+2.98	+2.38
H	+8.58	-6.23	Y	+3.35	+6.38	n	+3.71	-0.85
J	+6.23	-8.58	Z	+5.92	+4.09	p	-1.66	-3.43
K	+3.28	-10.09	a	+7.15	+0.87	q	+1.66	-3.43
L	0.00	-10.60	b	+6.73	-2.55	r	-3.71	-0.85
M	-3.26	-10.09	c	+4.78	-5.39	s	-2.98	+2.38
N	-6.23	-8.58	d	+1.73	-6.99	t	0.00	0.00
P	-8.58	-6.23	e	-1.73	-6.99			

23-21

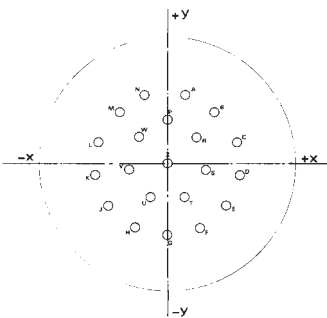

Cts	Coordinates		Cts	Coordinates	
	X	y		X	y
A	+3.25	+9.78	M	-7.34	+7.24
B	+7.34	+7.24	N	-3.25	+9.78
C	+9.80	+3.12	P	0.00	+6.22
D	+10.16	-1.65	R	+4.06	+3.71
E	+8.33	-6.07	S	+5.44	-0.89
F	+4.65	-9.19	T	+2.39	-4.93
G	0.00	-10.31	U	-2.39	-4.93
H	-4.65	-9.19	V	-5.44	-0.89
J	-8.33	-6.07	W	-4.06	+3.71
K	-10.16	-1.65	X	0.00	0.00
L	-9.80	+3.12			

23-32

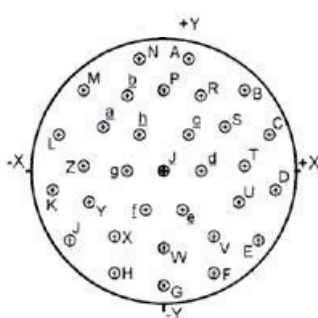

Cts	Coordinates		Cts	Coordinates		Cts	Coordinates	
	X	y		X	y		X	y
A	+2.54	+11.43	M	-8.26	+8.26	Z	-8.26	+0.64
B	+8.26	+8.26	N	-2.54	+11.43	a	-6.35	+4.45
C	+10.80	+3.81	P	0.00	+8.26	b	-3.81	+7.62
D	+11.43	-1.91	R	+3.81	+7.62	c	+2.54	+3.81
E	+9.53	-6.99	S	+6.35	+4.45	d	+3.81	0.00
F	+5.08	-10.16	T	+8.26	+0.64	e	+1.91	-3.81
G	0.00	-11.43	U	+7.62	-3.18	f	-1.91	-3.81
H	-5.08	-10.16	V	+5.08	-6.35	g	-3.81	0.00
J	-9.53	-6.99	W	0.00	-7.62	h	-2.54	+3.81
K	-11.43	-1.91	X	-5.08	-6.35	j	0.00	0.00
L	-10.80	+3.81	Y	-7.62	-3.18			

8LT Connectors



23-35

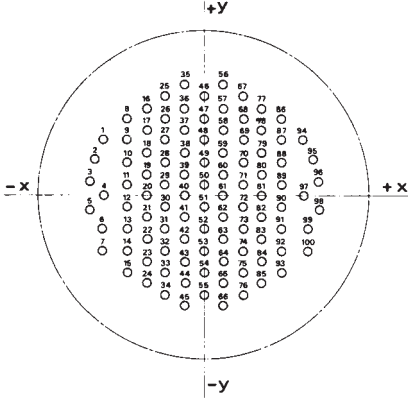

Cts	Coordinates		Cts	Coordinates	
	x	y		x	y
1	-10.87	+6.12	51	0.00	-1.19
2	-11.86	+3.91	52	0.00	-3.61
3	-12.40	+1.55	53	0.00	-6.02
4	-10.54	0.00	54	0.00	-8.43
5	-12.40	-1.55	55	0.00	-10.85
6	-10.87	-3.61	56	+2.11	+12.07
7	-10.87	-6.02	57	+2.11	+9.65
8	-8.43	+8.46	58	+2.11	+7.24
9	-8.43	+6.05	59	+2.11	+4.83
10	-8.43	+3.63	60	+2.11	+2.41
11	-8.43	+1.22	61	+2.11	0.00
12	-8.43	-1.19	62	+2.11	-2.41
13	-8.43	-3.61	63	+2.11	-4.83
14	-8.43	-6.02	64	+2.11	-7.24
15	-8.43	-8.43	65	+2.11	-9.65
16	-6.32	+9.65	66	+2.11	-12.07
17	-6.32	+7.24	67	+4.22	+10.87
18	-6.32	+4.83	68	+4.22	+8.46
19	-6.32	+2.41	69	+4.22	+6.05
20	-6.32	0.00	70	+4.22	+3.63
21	-6.32	-2.41	71	+4.22	+1.22
22	-6.32	-4.83	72	+4.22	-1.19
23	-6.32	-7.24	73	+4.22	-3.61
24	-6.32	-9.65	74	+4.22	-6.02
25	-4.22	+10.87	75	+4.22	-8.43
26	-4.22	+8.46	76	+4.22	-10.85
27	-4.22	+6.05	77	+6.32	+9.65
28	-4.22	+3.63	78	+6.32	+7.24
29	-4.22	+1.22	79	+6.32	+4.83
30	-4.22	-1.19	80	+6.32	+2.41
31	-4.22	-3.61	81	+6.32	0.00
32	-4.22	-6.02	82	+6.32	-2.41
33	-4.22	-8.43	83	+6.32	-4.83
34	-4.22	-10.85	84	+6.32	-7.24
35	-2.11	+12.07	85	+6.32	-9.65
36	-2.11	+9.65	86	+8.43	+8.46
37	-2.11	+7.24	87	+8.43	+6.05
38	-2.11	+4.83	88	+8.43	+3.63
39	-2.11	+2.41	89	+8.43	+1.22
40	-2.11	0.00	90	+8.43	-1.19
41	-2.11	-2.41	91	+8.43	-3.61
42	-2.11	-4.83	92	+8.43	-6.02
43	-2.11	-7.24	93	+8.43	-8.43
44	-2.11	-9.65	94	+10.87	+6.12
45	-2.11	-12.07	95	+11.86	+3.91
46	0.00	+10.87	96	+12.40	+1.55
47	0.00	+8.46	97	+10.54	0.00
48	0.00	+6.05	98	+12.40	-1.55
49	0.00	+3.63	99	+10.87	-3.61
50	0.00	+1.22	100	+10.87	-6.02

23-53

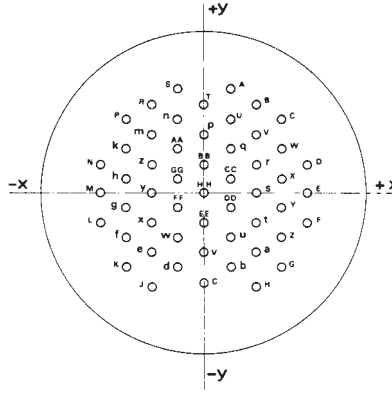

Cts	Coordinates		Cts	Coordinates	
	X	Y		X	Y
A	+2.84	+11.56	e	-5.72	-6.60
B	+5.72	+9.91	f	-8.53	-4.95
C	+8.53	+8.26	g	-8.53	-1.65
D	+11.43	+3.30	h	-8.53	+1.65
E	+11.43	0.00	k	-8.53	+4.95
F	+11.43	-3.30	m	-5.72	+6.60
G	+8.53	-8.26	n	-2.84	+8.26
H	+5.72	-10.41	p	0.00	+6.60
J	-5.72	-10.41	q	+2.84	+4.95
K	-8.53	-8.26	r	+5.72	+3.30
L	-11.43	-3.30	s	+5.72	0.00
M	-11.43	0.00	t	+5.72	-3.30
N	-11.43	+3.30	u	+2.84	-4.95
P	-8.53	+8.26	v	0.00	-6.60
R	-5.72	+9.91	w	-2.84	-4.95
S	-2.84	+11.56	x	-5.72	-3.30
T	0.00	+9.91	y	-5.72	0.00
U	+2.84	+8.26	z	-5.72	+3.30
V	+5.72	+6.60	AA	-2.84	+4.95
W	+8.53	+4.95	BB	0.00	+3.30
X	+8.53	+1.65	CC	+2.84	+1.65
Y	+8.53	-1.65	DD	+2.84	-1.65
Z	+8.53	-4.95	EE	0.00	-3.30
a	+5.72	-6.60	FF	-2.84	-1.65
b	+2.84	-8.26	GG	-2.84	+1.65
c	0.00	-9.91	HH	0.00	0.00
d	-2.84	-8.26			

25-04

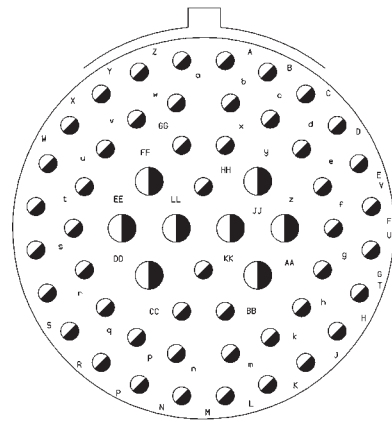

Cts	Coordinates		Cts	Coordinates	
	X	Y		X	Y
A	+1.75	+13.49	f	+10.46	0.00
B	+5.16	+12.57	g	+9.58	-3.35
C	+8.23	+10.80	h	+7.90	-6.38
D	+10.77	+8.28	k	+5.38	-8.78
E	+12.52	+5.21	m	+2.18	-10.08
F	+13.49	+1.75	n	-2.18	-10.08
G	+13.49	-1.75	p	-5.38	-8.78
H	+12.52	-5.21	q	-7.90	-6.38
J	+10.77	-8.28	r	-9.58	-3.35
K	+8.23	-10.80	s	-10.46	0.00
L	+5.16	-12.57	t	-9.58	+3.35
M	+1.75	-13.49	u	-7.90	+6.38
N	-1.75	-13.49	v	-5.38	+8.78
P	-5.16	-12.57	w	-2.18	+10.08
R	-8.23	-10.80	x	+1.75	+6.66
S	-10.77	-8.28	y	+4.37	+3.78
T	-12.52	-5.21	z	+6.55	0.00
U	-13.49	-1.75	AA	+4.37	-3.78
V	-13.49	+1.75	BB	+1.75	-6.66
W	-12.52	+5.21	CC	-1.75	-6.66
X	-10.77	+8.28	DD	-4.37	-3.78
Y	-8.23	+10.80	EE	-6.55	0.00
Z	-5.16	+12.57	FF	-4.37	+3.78
a	-1.75	+13.49	GG	-1.75	+6.66
b	+2.18	+10.08	HH	0.00	+3.35
c	+5.38	+8.78	JJ	+2.18	0.00
d	+7.90	+6.38	KK	0.00	-3.35
e	+9.58	+3.35	LL	+2.18	0.00

25-29

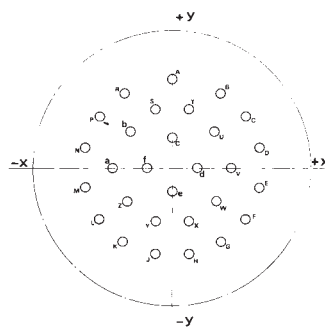

Cts	Coordinates		Cts	Coordinates	
	X	Y		X	Y
A	0.00	+12.22	S	-2.31	+8.15
B	+6.55	+10.31	T	+2.31	+8.15
C	+10.03	+7.04	U	+5.79	+4.93
D	+11.91	+2.77	V	+8.10	0.00
E	+11.91	-2.77	W	+6.10	-4.60
F	+10.03	-7.04	X	+2.31	-7.37
G	+6.68	-10.31	Y	-2.31	-7.37
H	+2.31	-11.99	Z	-6.10	-4.60
J	-2.31	-11.99	a	-8.10	0.00
K	-6.68	-10.31	b	-5.79	+4.93
L	-10.03	-7.04	c	0.00	+4.09
M	-11.91	-2.77	d	+3.40	0.00
N	-11.91	+2.77	e	0.00	-3.30
P	-10.03	+7.04	f	-3.40	0.00
R	-6.55	+10.31			

8LT Connectors



25-35

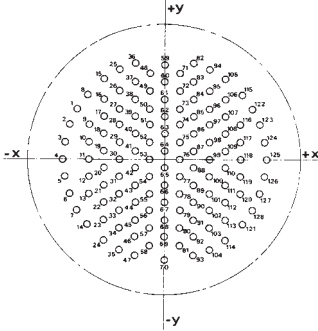

Cts	Coordinates		Cts	Coordinates		Cts	Coordinates		Cts	Coordinates		Cts	Coordinates		Cts	Coordinates	
	X	y		X	y		X	y		X	y		X	y		X	y
1	-12.17	+7.09	23	-8.43	-8.43	45	-4.22	-8.43	66	0.00	-3.61	87	+4.22	+1.19	108	+8.43	+3.61
2	-13.21	+4.83	24	-8.43	-10.85	46	-4.22	-10.85	67	0.00	-6.02	88	+4.22	-1.19	109	+8.43	+1.19
3	-13.87	+2.41	25	-6.32	+12.60	47	-4.22	-13.26	68	0.00	-8.43	89	+4.22	-3.61	110	+8.43	-1.19
4	-14.10	0.00	26	-6.32	+9.65	48	-2.11	+12.07	69	0.00	-10.85	90	+4.22	-6.02	111	+8.43	-3.61
5	-13.87	-2.41	27	-6.32	+7.24	49	-2.11	+9.65	70	0.00	-14.10	91	+4.22	-8.43	112	+8.43	-6.02
6	-13.21	-4.83	28	-6.32	+4.83	50	-2.11	+7.24	71	+2.11	+12.07	92	+4.22	-10.85	113	+8.43	-8.43
7	-12.17	-7.09	29	-6.32	+2.41	51	-2.11	+4.83	72	+2.11	+9.65	93	+4.22	-13.26	114	+8.43	-10.85
8	-10.77	-9.07	30	-6.32	0.00	52	-2.11	+2.41	73	+2.11	+7.24	94	+6.32	+12.60	115	+10.77	+9.07
9	-10.54	+4.83	31	-6.32	-2.41	53	-2.11	0.00	74	+2.11	+4.83	95	+6.32	+9.67	116	+10.54	+4.83
10	-10.54	+2.41	32	-6.32	-4.83	54	-2.11	-2.41	75	+2.11	+2.41	96	+6.32	+7.24	117	+10.54	+2.41
11	-10.54	0.00	33	-6.32	-7.24	55	-2.11	-4.83	76	+2.11	0.00	97	+6.32	+4.83	118	+10.54	0.00
12	-10.54	-2.41	34	-6.32	-9.65	56	-2.11	-7.24	77	+2.11	-2.41	98	+6.32	+2.41	119	+10.54	-2.41
13	-10.54	-4.83	35	-6.32	-12.07	57	-2.11	-9.65	78	+2.11	-4.83	99	+6.32	0.00	120	+10.54	-4.83
14	-10.77	-9.07	36	-4.06	+13.49	58	-2.11	-12.07	79	+2.11	-7.24	100	+6.32	-2.41	121	+10.77	-9.07
15	-8.43	+11.28	37	-4.22	+10.85	59	0.00	+13.26	80	+2.11	-9.65	101	+6.32	-4.83	122	+12.17	+7.09
16	-8.43	+8.43	38	-4.22	+8.43	60	0.00	+10.85	81	+2.11	-12.07	102	+6.32	-7.24	123	+13.21	+4.83
17	-8.43	+6.02	39	-4.22	+6.02	61	0.00	+8.43	82	+4.06	+13.49	103	+6.32	-9.65	124	+13.87	+2.41
18	-8.43	+3.61	40	-4.22	+3.61	62	0.00	+6.02	83	+4.22	+10.85	104	+6.32	-12.07	125	+14.10	0.00
19	-8.43	+1.19	41	-4.22	+1.19	63	0.00	+3.61	84	+4.22	+8.43	105	+8.43	+11.28	126	+13.87	-2.41
20	-8.43	-1.19	42	-4.22	-1.19	64	0.00	+1.19	85	+4.22	+6.02	106	+8.43	+8.43	127	+13.21	-4.83
21	-8.43	-3.61	43	-4.22	-3.61	65	0.00	-1.19	86	+4.22	+3.61	107	+8.43	+6.02	128	+12.17	-7.09
22	-8.43	-6.02	44	-4.22	-6.02												

25-43

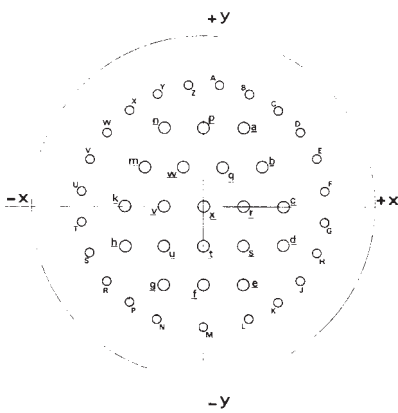

Cts	Coordinates		Cts	Coordinates		Cts	Coordinates	
	X	y		X	y		X	y
A	+1.75	+13.49	S	-12.52	-5.21	g	-4.37	-8.74
B	+5.16	+12.57	T	-13.49	-1.75	h	-8.74	-4.37
C	+8.23	+10.80	U	-13.49	+1.75	k	-8.74	0.00
D	+10.77	+8.28	V	12.52	+5.21	m	-6.55	+4.37
E	+12.52	+5.21	W	-10.77	+8.28	n	-4.37	+8.74
F	+13.49	+1.75	X	-8.23	+10.80	p	0.00	+8.74
G	+13.49	-1.75	Y	-5.16	+12.57	q	+2.18	+4.37
H	+12.52	-5.21	Z	-1.75	+13.49	r	+4.37	0.00
J	+10.77	-8.28	a	+4.37	+8.74	s	+4.37	-4.37
K	+8.23	-10.80	b	+6.55	+4.37	t	0.00	-4.37
L	+5.16	-12.57	c	+8.74	0.00	u	-4.37	-4.37
M	0.00	-13.49	d	+8.74	-4.37	v	-4.37	0.00
N	-5.16	-12.57	e	+4.37	-8.74	w	-2.18	+4.37
P	-8.23	-10.80	f	0.00	-8.74	x	0.00	0.00
R	-10.77	-8.28						

25-61

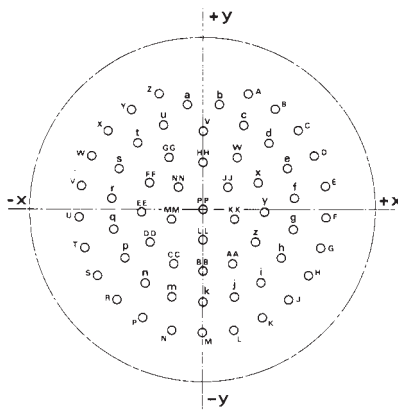

Cts	Coordinates		Cts	Coordinates		Cts	Coordinates	
	X	y		X	y		X	y
A	+4.98	+12.70	y	-7.98	-11.05	u	-4.39	+9.22
B	+7.98	+11.05	Z	-4.98	+12.10	v	0.00	+8.59
C	+10.49	+8.71	a	-1.73	+11.53	w	+3.73	+5.66
D	+12.32	+5.84	b	+1.73	+11.53	x	+6.02	+3.10
E	+13.39	+2.57	c	+4.39	+9.22	y	+6.78	-0.25
F	+13.61	-0.76	d	+7.24	+7.19	z	+5.79	-3.53
G	+12.98	-4.17	e	+9.19	+4.45	AA	+3.33	-5.92
H	+11.53	-7.29	f	+10.13	+1.17	BB	0.00	-6.78
J	+9.35	-9.93	g	+9.96	-2.24	CC	-3.33	-5.92
K	+6.58	-11.94	h	+8.66	-5.41	DD	-5.79	-3.53
L	+3.40	-13.18	i	+6.38	-7.98	EE	-6.78	-0.25
M	0.00	-13.64	j	+3.38	-9.63	FF	-6.02	+3.10
N	-3.40	-13.18	k	0.00	-10.21	GG	-3.73	+5.66
P	-6.58	-11.94	m	-3.38	-9.63	HH	0.00	+5.08
R	-9.35	-9.93	n	-6.38	-7.98	JJ	+2.67	+2.39
S	-11.53	-7.29	p	-8.66	-5.41	KK	+3.43	-1.04
T	-12.98	-4.17	q	-9.96	-2.24	LL	0.00	-3.35
U	-13.61	-0.76	r	-10.13	+1.17	MM	-3.43	-1.04
V	-13.39	+2.57	s	-9.19	+4.45	NN	-2.67	+2.39
W	-12.32	+5.84	t	-7.24	+7.19	PP	0.00	0.00
X	-10.49	+8.71						

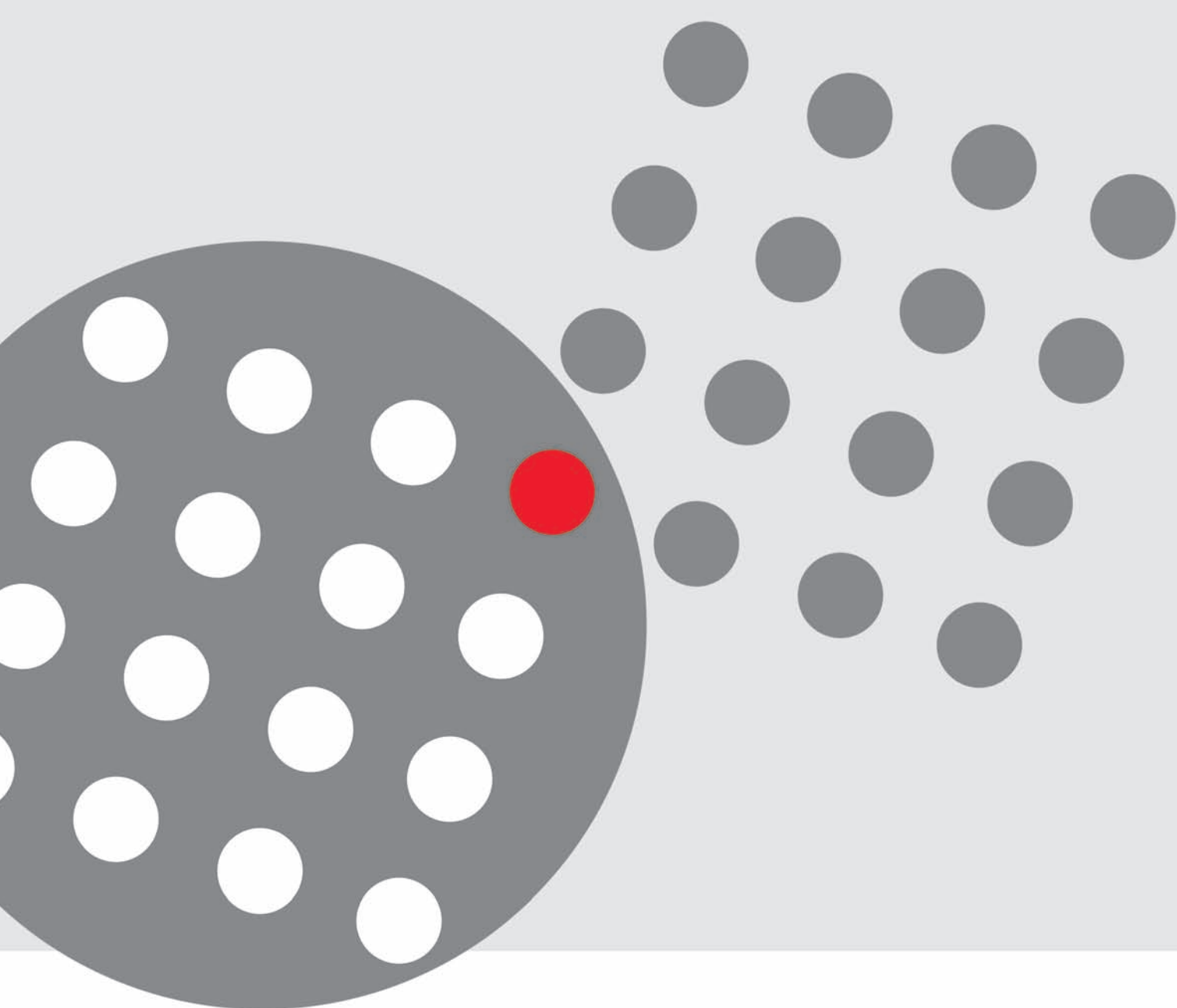

www.souriau.com
contactmilaero@souriau.com



X-ON Electronics

Largest Supplier of Electrical and Electronic Components

Click to view similar products for [Circular MIL Spec Connector](#) category:

Click to view products by [Sunbank](#) manufacturer:

Other Similar products are found below :

[89075GULPR](#) [0025-262-542](#) [0025-264-3014](#) [58-570121-04S](#) [0134-213-1208](#) [0134-213-2209](#) [0025-258-000](#) [60-042022-07P](#) [60-042022-19P](#)
[60-042022-23P](#) [60-042217-10P](#) [0114-201-1278](#) [012-0467-000](#) [602GB06EG24-61SN](#) [0134-201-1207](#) [0134-213-1006](#) [6104-207-2302](#) [6104-](#)
[208-1902](#) [61-168211-04P](#) [61-168617-10P](#) [6131-202-19149P](#) [6131-204-21149P](#) [6131-208-13149P](#) [6131-209-17149P](#) [6131-210-11149P](#) [6131-](#)
[211-19149P](#) [6131-216-19149P](#) [6131-259-21149P](#) [6131-259-23149P](#) [6131-265-17149P](#) [6131-265-19149P](#) [CS3100A18-1P-472](#) [CS3100A-36-](#)
[77P](#) [CS3101A-16-55P](#) [CS3102A-10SL-55P](#) [CS3102A-14S-58P](#) [CS3102A-32-17P](#) [CS3102A32-25S](#) [CS3102C18-4P-472](#)
[CS3106A10SL3S004](#) [CS3106A-18-73S](#) [CS3108A-14S-52S](#) [CS3108A-28-51S](#) [6162-233-1277](#) [6162-324-1231](#) [M243082296Z](#)
[M2884010AC1S1](#) [CT0-24-10SC](#) [CT0M20-7PCAU](#) [M28840/17AC1G3](#)