

# Digital Fiber Amplifier E3X-DA-N

CSM\_E3X-DA-N\_DS\_E\_7\_1

Manufacturing of the E3X-DA□TW Series was discontinued at the end of March 2012.

## The Ultimate Fiber Amplifier for Maximum Ease of Use and High Performance



 Be sure to read *Safety Precautions* on page 23.

**UL991\***

\*UL certification including UL 991 testing and evaluation • Applicable standards: UL 3121-1  
• Additional application testing and evaluations standards: UL 991 and SEMI S2-0200S

## Features

### Models with New Connector System Reduces Wiring, Saves Space, and Makes Maintenance Easier

**First in the Industry Patent Pending**

In Amplifiers with wire-saving connectors, the power supply is distributed to 1-conductor slave connectors through a 3-conductor master connector. This design has three major advantages.

1. Wiring time is significantly reduced.
2. Relay connectors are unnecessary, so wiring takes up less space and costs are reduced.
3. Storage and maintenance are simpler because it isn't necessary to distinguish between master connector and slave connectors on the Amplifier.

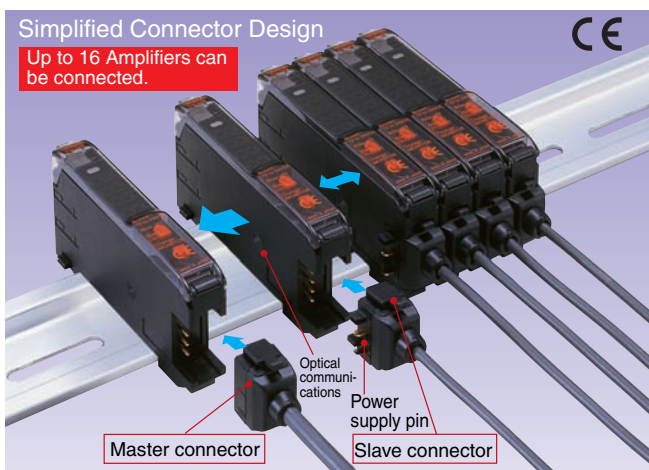

### Super Digital Display with Auto Power Control (APC) Circuit

**First in the Industry**

The passage of time causes the intensity of the Sensor's light-emitting LED elements to deteriorate, which may make stable detection impossible.

The E3X-DA-N is the first series of Fiber Sensors to use an Auto Power Control (APC) circuit. This achieves strict detection by eliminating fluctuation in the digital value and is ideal for subtle detection such as stable detection of liquid-crystal glass.

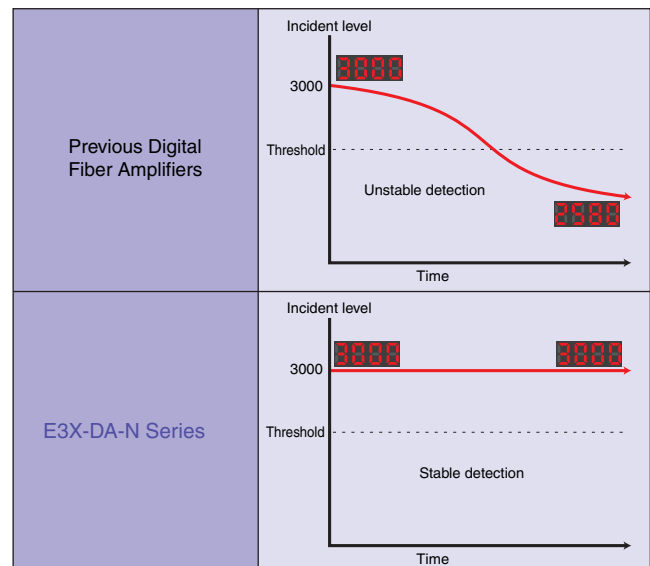

**Power Consumption Reduced by As Much As 70%**

Power consumption is reduced by as much as 70% from 1800 mW to 600 mW (when the digital display is OFF).

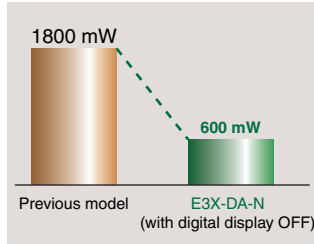

**Digital Display Can Be Turned OFF or Dimmed during Operation**

**Eco-mode**

When the digital display is viewed infrequently during operation, current consumption can be reduced by dimming the display, or turning it OFF entirely. (Eco-mode can be set from the Mobile Console only.)

**New Generation of Mobile Consoles the Size of Cellular Phones. Further Developing the Ultimate Power of Fiber Amplifiers.**

**Remote Setting and Adjustment**

Perform settings, teaching, and fine adjustments at the end of the Fiber Unit.

Previously, settings and teaching could be performed only on the Amplifier. Now, however, using a Mobile Console enables these operations at the end of the fiber. Strict adjustments can be made while checking the workpiece position.



**With group teaching, teach multiple amplifiers simultaneously.**

The tedious teaching that had to be performed separately for each Amplifier can now be performed for several Amplifiers at once using the Mobile Console.

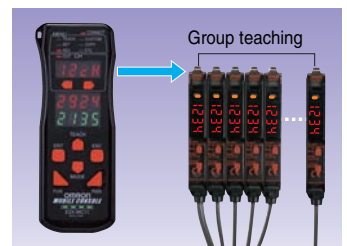

**Eliminate inconsistency by using group zero reset.**

The group zero reset function can simultaneously reset the digital displays of multiple Amplifiers to 0. This function is useful to minimize variation between Amplifier values.

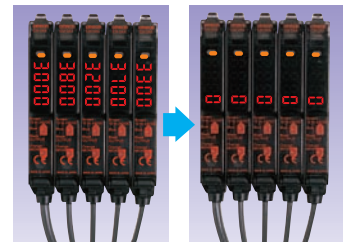

**Display the light intensity and threshold at the same time.**

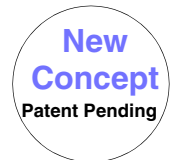

**Flash the Sensor head and display the amplifier channels during operation.**

Even if the Amplifier and Sensor head are separated during operation, it is still possible to flash the Sensor head and display the amplifier channels.

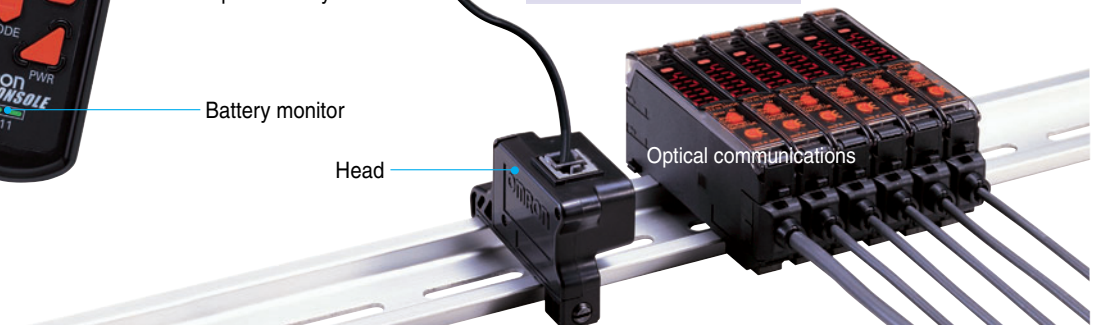

## Ordering Information

### Amplifiers

#### Pre-wired Amplifiers

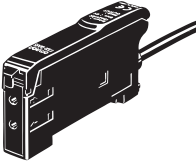
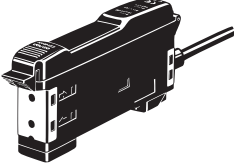
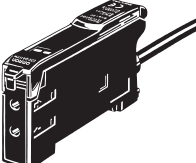
Type	Appearance	Control output	Model	
			NPN output	PNP output
Standard models		ON/OFF output	E3X-DA11-N 2M	E3X-DA41-N 2M
Monitor-output models		• ON/OFF output • Monitor output	E3X-DA21-N 2M	E3X-DA51-N 2M
Mark-detecting models (blue LED)		ON/OFF output	E3X-DAB11-N 2M	E3X-DAB41-N 2M
Mark-detecting models (green LED)			E3X-DAG11-N 2M	E3X-DAG41-N 2M
Infrared models			E3X-DAH11-N 2M	E3X-DAH41-N 2M
Differential-output model *1			E3X-DA11D 2M	---
Water-resistant models		ON/OFF output	E3X-DA11V 2M	E3X-DA41V 2M
Twin-output models			E3X-DA11TW 2M *2	E3X-DA41TW 2M *2

\*1. For details, refer to page 6.

\*2. Manufacturing of the E3X-DA□TW Series was discontinued at the end of March 2012.

#### Amplifiers with Standard Connectors

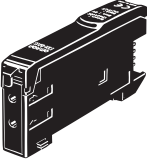
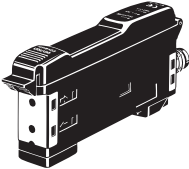
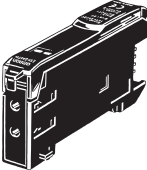
Type	Appearance	Applicable Connector (order separately)		Control output	Model	
					NPN output	PNP output
Standard models		Master	E3X-CN11	ON/OFF output	E3X-DA6	E3X-DA8
		Slave	E3X-CN12			
Monitor-output models		Master	E3X-CN21	• ON/OFF output • Monitor output	E3X-DA7	E3X-DA9
		Slave	E3X-CN22			
Mark-detecting models (Blue LED)		ON/OFF output	Master	E3X-CN11	E3X-DAB6	E3X-DAB8
			Slave	E3X-CN12		
Mark-detecting models (Green LED)			Master	E3X-CN11	E3X-DAG6	E3X-DAG8
			Slave	E3X-CN12		
Infrared models		Master	E3X-CN11	E3X-DAH6	E3X-DAH8	
		Slave	E3X-CN12			
Differential-output model *1		Master	E3X-CN11	E3X-DA6D	---	
		Slave	E3X-CN12			
Water-resistant models (M8 connector)		XS3F-M421-40□-A XS3F-M422-40□-A		ON/OFF output	E3X-DA14V	E3X-DA44V
Twin-output models		Master	E3X-CN21	ON/OFF output	E3X-DA6TW *2	E3X-DA8TW *2
		Slave	E3X-CN22			

\*1. For details, refer to page 6.

\*2. Manufacturing of the E3X-DA□TW Series was discontinued at the end of March 2012.

**Amplifier Connectors (Order Separately)** Note: Seal provided as accessory.

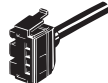
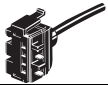
Type	Appearance	Cable length	No. of conductors	Model
Master Connector		2 m	3	E3X-CN11
			4	E3X-CN21
Slave Connector			1	E3X-CN12
			2	E3X-CN22

**Combining Amplifiers and Connectors (Basically Amplifiers and Connectors are sold separately.)**



Refer to the following tables when placing an order.

Amplifiers			Applicable Connectors (Order Separately)	
Type	NPN	PNP	Master Connector	Slave Connector
Standard models	E3X-DA6	E3X-DA8	E3X-CN11	E3X-CN12
Mark-detecting models	E3X-DAB6	E3X-DAB8		
		E3X-DAG6	E3X-DAG8	
Infrared models	E3X-DAH6	E3X-DAH8	E3X-CN21	E3X-CN22
Differential-output model	E3X-DA6D	---		
Monitor-output models	E3X-DA7	E3X-DA9		
Twin-output models	E3X-DA6TW	E3X-DA8TW		





**When Using 5 Amplifiers**

Amplifiers (5 Units)	+	1 Master Connector	4 Slave Connectors
----------------------	---	--------------------	--------------------

**Sensor I/O Connectors (Order Separately)**



Size	Cable specifications	Appearance	Cable type	Model	
M8	Standard cable	Straight connector 	2 m	4-wire connection	XS3F-M421-402-A
			5 m		XS3F-M421-405-A
		L-shaped connector 	2 m		XS3F-M422-402-A
			5 m		XS3F-M422-405-A

## Mobile Console (Order Separately)

Appearance	Model	Remarks
	(model number of set) <b>E3X-MC11</b>	Mobile Console with head, cable, and AC adapter provided as accessories. Power supply method: chargeable battery
	<b>E3X-MC11-C1</b>	Mobile Console
	<b>E3X-MC11-H1</b>	Head
	<b>E39-Z12-1</b>	Cable (1.5 m)

## Accessories (Order Separately)

### Mounting Brackets

Appearance	Applicable model	Model	Quantity	Remarks
	E3X-DA-N Series	<b>E39-L143</b>	1	---
	E3X-DA□V	<b>E39-L148</b>		

\*When using a Through-beam Fiber Unit, order one Bracket for the Receiver and one for the Emitter.

### Operating Instructions Sticker

Model	Remarks
<b>E39-Y1</b>	Attach near the Sensor. → Refer to page 25.

### End Plate

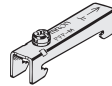
Appearance	Model	Quantity
	<b>PFP-M</b>	1

## Ratings and Specifications

For dimensions, refer to page 26 to 29.

## Amplifiers

## Pre-wired Amplifiers

Item	Output type	Type	Standard models	Monitor-output models	Mark-detecting models		Infrared models	Water-resistant models	Twin-output models
		NPN output	E3X-DA11-N	E3X-DA21-N	E3X-DAB11-N	E3X-DAG11-N	E3X-DAH11-N	E3X-DA11V	E3X-DA11TW
	PNP output	E3X-DA41-N	E3X-DA51-N	E3X-DAB41-N	E3X-DAG41-N	E3X-DAH41-N	E3X-DA41V	E3X-DA41TW	
Light source (wavelength)		Red LED (660 nm)		Blue LED (470 nm)	Green LED (525 nm)	Infrared LED (870 nm)	Red LED (660 nm)		
Power supply voltage		12 to 24 VDC±10%, ripple (p-p) 10% max.							
Power consumption		Normally: 960 mW max. (current consumption: 40 mA max. at power supply voltage of 24 VDC) Eco Mode: 720 mW max. (current consumption: 30 mA max. at power supply voltage of 24 VDC) Digital display not lit: 600 mW max. (current consumption: 25 mA max. at power supply voltage of 24 VDC)							
Control output	ON/OFF output	Load current: 50 mA (residual voltage (NPN/PNP): 1 V max., Open collector (NPN or PNP output, depending on the model) Light ON/Dark ON selectable							
	Monitor output	---	Load 1 to 5 VDC, 10 kΩ min.	---					---
Protection circuit		Power supply reverse polarity, Output short-circuit protection, Mutual interference prevention (supported for up to 10 Units)							
Response time	Super-high-speed mode	0.25 ms for operation and reset respectively						0.5 ms for operation and reset respectively	
	Standard mode	1 ms for operation and reset respectively						2 ms for operation and reset	
	Super-long-distance mode	4 ms for operation and reset respectively						7 ms for operation and reset respectively	
Sensitivity setting		Teaching or manual method							
Functions	Timer function	OFF-delay timer: 0 to 200 ms, 1 to 20 ms (set in 1-ms units); 20 to 200 ms (set in 5-ms units) Using Mobile Console: OFF delay, ON delay, or one shot (selectable)							
	Automatic power control (APC)	Fiber-optic current digital control			---			Fiber-optic current digital control	
	Zero-reset	Negative values can be displayed.							
	Initial reset	Settings can be returned to defaults as required.							
	Monitor focus	---	Upper and lower limits can be set as required for every 100 digital values.	---					
Indicators		Operation indicator (orange), 7-segment digital incident level display (red), 7-segment digital incident level percentage display (red), threshold and excess gain 2-color double bar indicators (green and red), 7-segment digital threshold display (red)							
Display timing		Switching between normal/peak-hold/bottom-hold possible							
Display orientation		Switching between normal/reverse possible							
Optical axis adjustment		Optical axis adjustment possible (hyper-flashing function)							
Ambient illumination (receiver side)		Incandescent lamp: 10,000 lx max. Sunlight: 20,000 lx max.							



Item	Output type	Type	Standard models	Monitor-output models	Mark-detecting models		Infrared models	Water-resistant models	Twin-output models
		NPN output	E3X-DA11-N	E3X-DA21-N	E3X-DAB11-N	E3X-DAG11-N	E3X-DAH11-N	E3X-DA11V	E3X-DA11TW
		PNP output	E3X-DA41-N	E3X-DA51-N	E3X-DAB41-N	E3X-DAG41-N	E3X-DAH41-N	E3X-DA41V	E3X-DA41TW
<b>Ambient temperature</b>		Operating: Groups of 1 to 3 Amplifiers: -25 to 55°C Groups of 4 to 11 Amplifiers: -25 to 50°C Groups of 12 to 16 Amplifiers: -25 to 45°C Storage: -30 to 70°C (with no icing or condensation)							
<b>Ambient humidity</b>		Operating and storage: 35% to 85% (with no condensation)							
<b>Insulation resistance</b>		20 MΩ min. (at 500 VDC)							
<b>Dielectric strength</b>		1,000 VAC at 50/60 Hz for 1 min							
<b>Vibration resistance (destruction)</b>		10 to 55 Hz with a 1.5-mm double amplitude for 2 h each in X, Y and Z directions							
<b>Shock resistance (destruction)</b>		500m/s <sup>2</sup> , for 3 times each in X, Y and Z directions							
<b>Degree of protection</b>		IEC IP50 (with Protective Cover attached)						IEC IP66 (with Protective Cover attached)	IEC IP50 (with Protective Cover attached)
<b>Connection method</b>		Pre-wired (standard cable length: 2 m)							
<b>Weight (packed state)</b>		Approx. 100 g						Approx. 110 g	Approx. 100 g
<b>Material</b>	<b>Case</b>	Polybutylene terephthalate (PBT)							
	<b>Cover</b>	Polycarbonate						Polyethersulfone	
<b>Accessories</b>		Instruction sheet							

## Amplifiers with Connectors (Specifications different to those for Pre-wired Amplifiers)

Item	Output type	Type	Standard models	Monitor-output models	Mark-detecting models		Infrared models	Water-resistant models*	Twin-output models
		NPN output	E3X-DA6	E3X-DA7	E3X-DAB6	E3X-DAG6	E3X-DAH6	E3X-DA14V	E3X-DA6TW
		PNP output	E3X-DA8	E3X-DA9	E3X-DAB8	E3X-DAG8	E3X-DAH8	E3X-DA44V	E3X-DA8TW
<b>Connection method</b>		Standard connector						M8 connector	Standard connector
<b>Weight (packed state)</b>		Approx. 55 g						Approx. 65 g	Approx. 55 g

\*The dielectric strength for water-resistant models is 500 VAC at 50/60 Hz for 1 min.

## Connectors

Item	Model	E3X-CN11/21/22	E3X-CN12
<b>Rated current</b>	2.5 A		
<b>Rated voltage</b>	50 V		
<b>Contact resistance</b>	20 mΩ max. (20 mVDC max., 100 mA max.) The figure is for connection to the Amplifier and the adjacent Connector. It does not include the conductor resistance of the cable.		
<b>No. of insertions (durability)</b>	50 times The figure for the number of insertions is for connection to the Amplifier and the adjacent Connector.		
<b>Material</b>	<b>Housing</b>	Polybutylene terephthalate (PBT)	
	<b>Contacts</b>	Phosphor bronze/gold-plated nickel	
<b>Weight (packed state)</b>	Approx. 55 g		Approx. 25 g

## Mobile Console

Item	Model	E3X-MC11
<b>Power supply voltage</b>	Charged with AC adapter	
<b>Connection method</b>	Connected via adapter	
<b>Weight (packed state)</b>	Approx. 580 g (Console only: 120 g)	
Refer to <i>Instruction Manual</i> provided with the Mobile Console for details.		

## Digital Fiber Amplifiers with Differential Outputs (E3X-DA11D/E3X-DA6D)

### Characteristics of Applicable Fiber Units

#### Through-beam Fiber Units

Sensitivity selection 11-level setting Response time Fiber Unit	Sensing distance (mm) (The figures in parentheses apply when using the 39-F1 Lens Unit.)						Standard object (mm) *1 (min. sensing object *2: opaque)
	HIGH			LOW			
	1	2	3 to 11	1	2	3 to 11	
	270 or 570 $\mu$ s	0.5 or 1 ms	1 to 200 ms or 2 to 400 ms	270 or 570 $\mu$ s	0.5 or 1 ms	1 to 200 ms or 2 to 400 ms	
E32-T11R	240 (1680)	280 (1960)	370 (2590)	140 (980)	180 (1260)	240 (1680)	1 dia. (0.01 dia.)
E32-T21R	50	60	80	30	40	50	
E32-T16WR	580	690	910	350	450	580	(0.3 dia.) *1
E32-T16PR	380	450	600	230	290	380	(0.2 dia.) *2

\*1. These values are for sensing objects that are moving.

\*2. This value applies when the response time is set to 3 to 11. An object of this value is detectable if the temperature changes within the range of ambient operating temperature. (The value is for sensing objects that are moving.)

\*3. The values given in the above table are those that can be detected at a digital value of 1,000 in each sensing area.

#### Reflective Fiber Units

Sensitivity selection 11-level setting Response time Fiber Unit	Sensing distance (mm) *1						Standard object (mm) *2 (min. sensing object *3: opaque)
	HIGH			LOW			
	1	2	3-11	1	2	3-11	
	270 or 570 $\mu$ s	0.5 or 1 ms	1 to 200 ms or 2 to 400 ms	270 or 570 $\mu$ s	0.5 or 1 ms	1 to 200 ms or 2 to 400 ms	
E32-D11R	80	90	120	45	60	80	150 $\times$ 150 (0.01 dia.)
E32-D21R	13	15	20	7	10	13	25 $\times$ 25 (0.01 dia.)

\*1. Sensing distances are given for white paper.

\*2. These values are for sensing objects that are moving.

\*3. This value applies when the response time is set to 3 to 11. An object of this value is detectable if the temperature changes within the range of ambient operating temperature. (The value is for sensing objects that are moving.)

#### Differences Compared with E3X-DA-N Amplifier

Item	Type NPN output	Differential-output Models (Edge-detection Models)	
		Pre-wired	Wire-saving connector
		E3X-DA11D	E3X-DA6D
Current consumption		960 mW max. (current consumption: 40 mA max. at power supply voltage of 24 VDC)	
Control output	ON/OFF output	Load current: 50 mA max., (Residual voltage: 1 V max. for NPN/PNP output) Open collector Switchable between Light ON (ON at edge detection) and Dark ON (OFF at edge detection)	
Detection mode		Switchable between single edge and double edge detection mode	
Response time		Single edge: Can be set to 270 $\mu$ s, 500 $\mu$ s, 1 ms, 2 ms, 4 ms, 10 ms, 20 ms, 30 ms, 50 ms, 100 ms, or 200 ms. Double edge: Can be set to 570 $\mu$ s, 1 ms, 2 ms, 4 ms, 10 ms, 20 ms, 30 ms, 50 ms, 100 ms, 200 ms or 400 ms.	
Func-tions	Timer functions	Light ON: OFF-delay timer, Dark ON: ON-delay timer 0 to 5 s (1 to 20 ms: 1-ms units, 20 to 200 ms: 5-ms units, 200 ms to 1 s: 100 ms, 1 to 5 s: 1-s units)	
	APC	Yes	
	Zero-reset	Yes (Negative values can be displayed.)	
	Initial reset	Yes (Settings can be returned to defaults.)	
	Sensitivity selection	Yes (HIGH/LOW)	
	Teaching level	One-point teaching level can be varied from 1% to 50% in increments of 1%	
Indicators		Operation indicator (orange), 7-segment digital incident level display (red), 7-segment digital detection level display (red)	

For other information, refer to the instruction manual supplied with the product.



Engineering Data (Reference Value)

E3X-DA-N/E3X-DA□V/E3X-DA□TW

**Parallel Operating Range** At maximum sensitivity. (Use for optical axis adjustment at installation.)

**Through-beam**  
**E32-T11L**

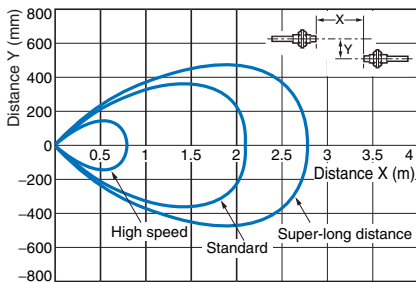

**Through-beam**  
**E32-T11L + E39-F1 (separately sold**  
**Long-distance Lens Unit)**

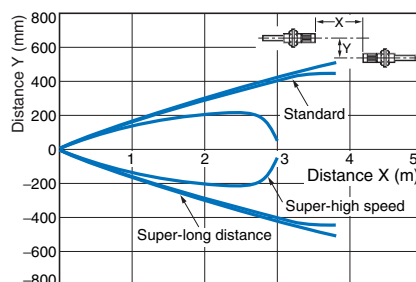

**Through-beam**  
**E32-T12L**

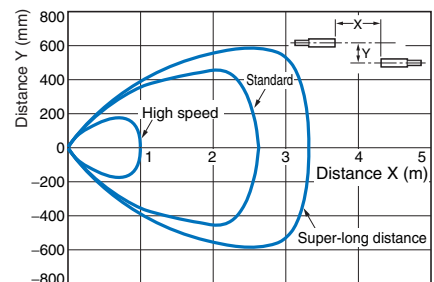

**Through-beam**  
**E32-TC200**

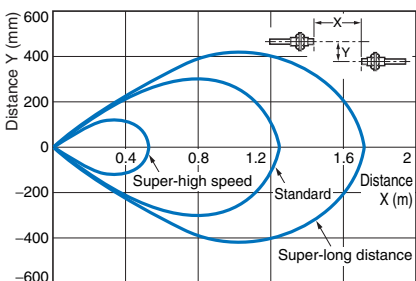

**Through-beam**  
**E32-TC200 + E39-F1 (separately sold**  
**Long-distance Lens Unit)**

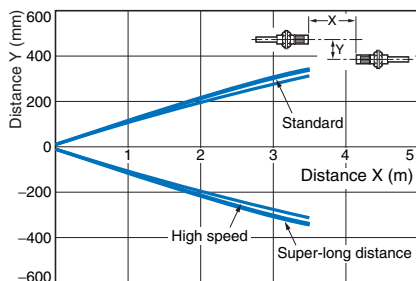

**Through-beam**  
**E32-T11R**

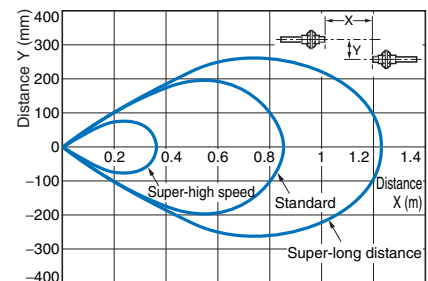

**Through-beam**  
**E32-T12R**

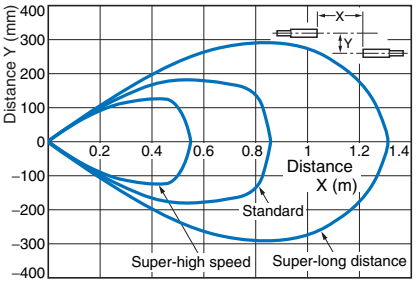

**Through-beam**  
**E32-T21R**

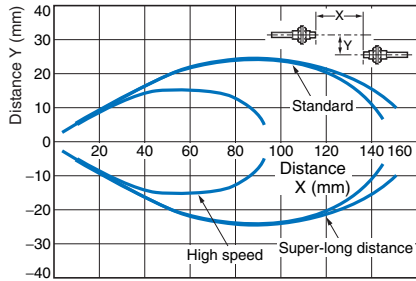

**Through-beam**  
**E32-T22R**

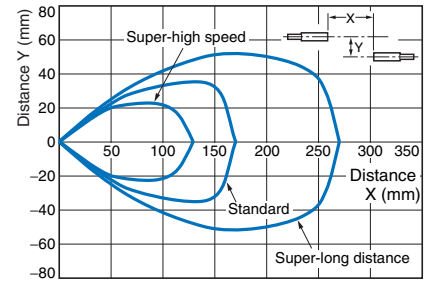

**Through-beam**  
**E32-T11**

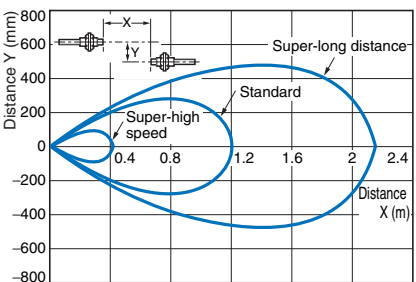

**Through-beam**  
**E32-T22B**

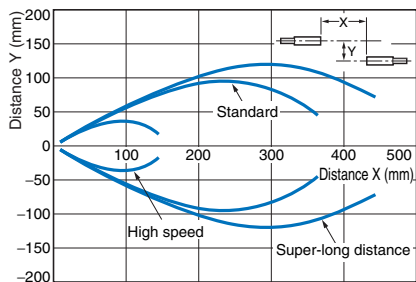

**Through-beam**  
**E32-T14LR**

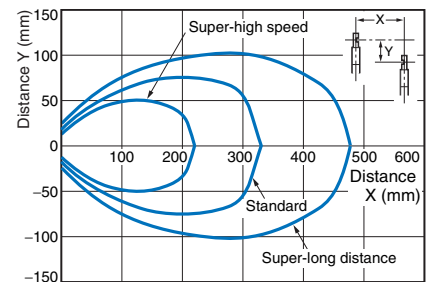

**Through-beam  
E32-T24R**

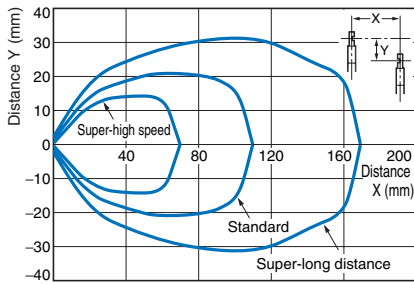

**Through-beam  
E32-T61**

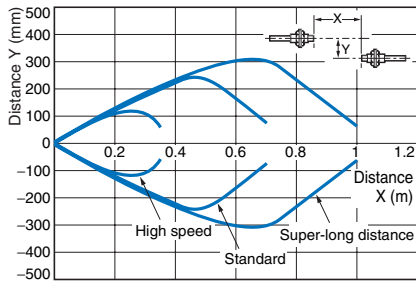

**Through-beam  
E32-T24S**

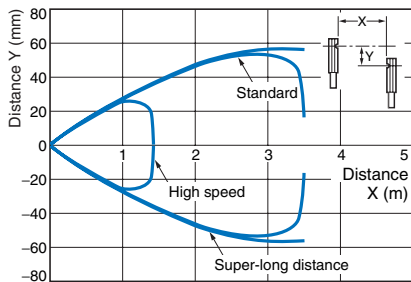

**Through-beam  
E32-T16J**

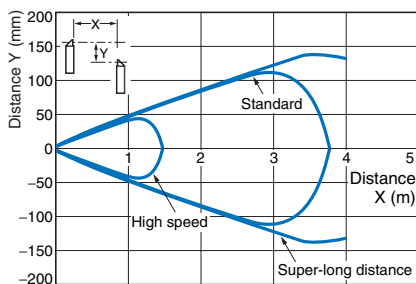

**Through-beam  
E32-T16P**

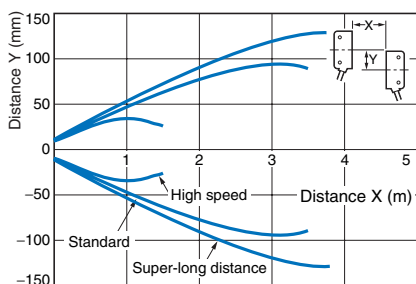

**Through-beam  
E32-T81R**

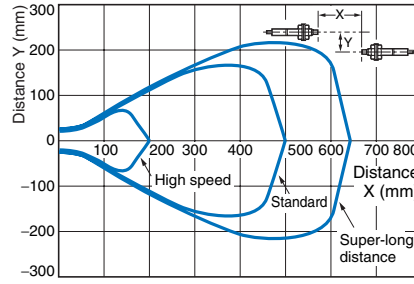

**Through-beam  
E32-T61 + E39-F1 (separately sold  
Long-distance Lens Unit)**

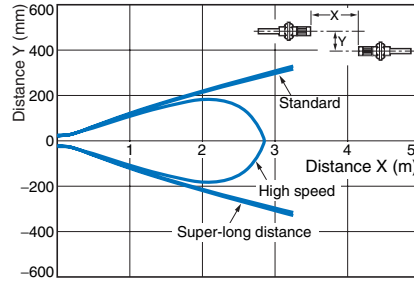

**Through-beam  
E32-T16W**

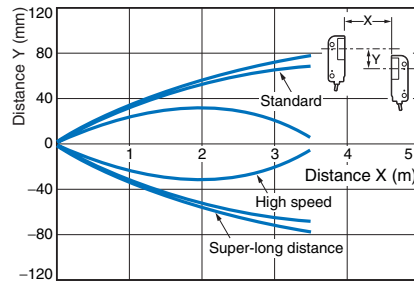

**Through-beam  
E32-T16J**

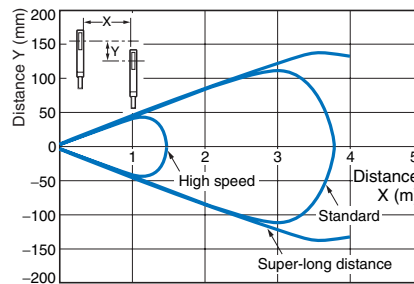

**Through-beam  
E32-T16PR**

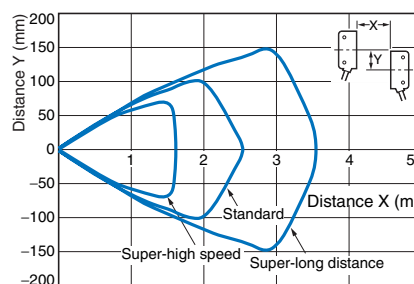

**Through-beam  
E32-T51**

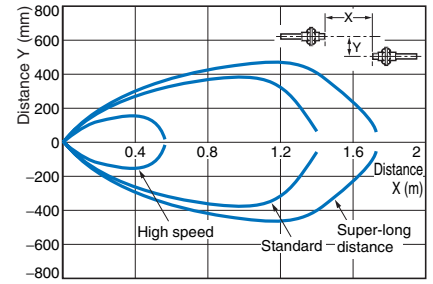

**Through-beam  
E32-T22S**

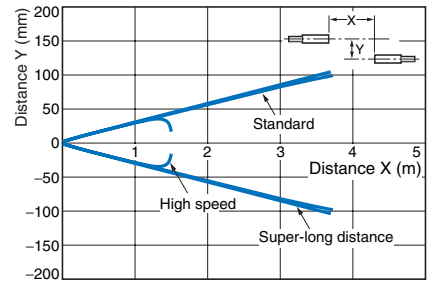

**Through-beam  
E32-T16WR**

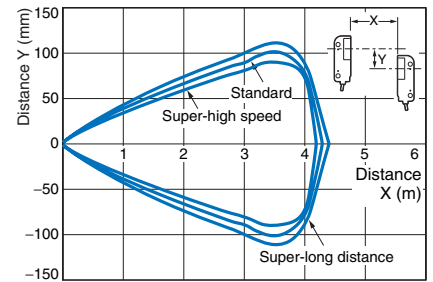

**Through-beam  
E32-T16JR**

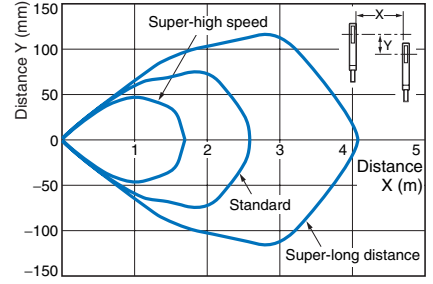

**Operating Range** With standard sensing object at maximum sensitivity. (Use for the positioning of the object and Sensor.)

**Reflective**  
**E32-D21L**

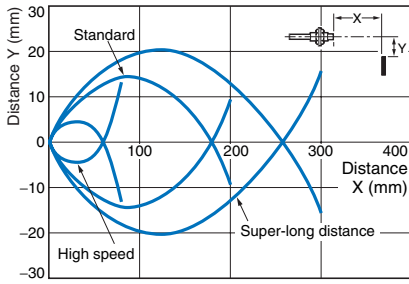

**Reflective**  
**E32-DC200**

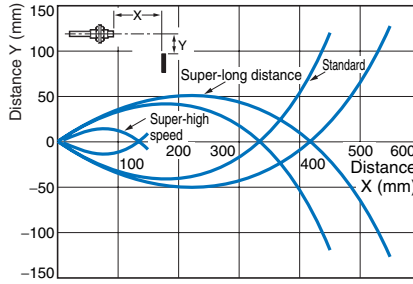

**Reflective**  
**E32-D11R**

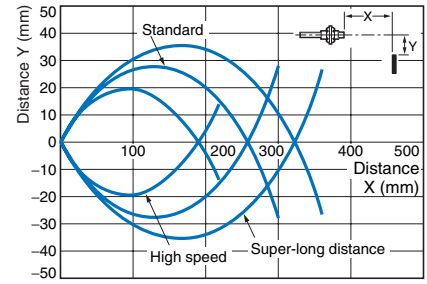

**Reflective**  
**E32-D12R**

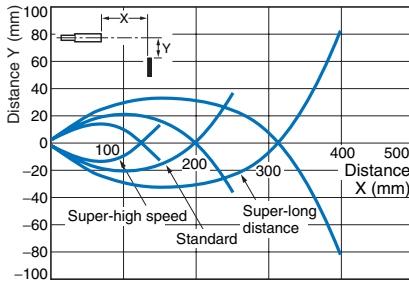

**Reflective**  
**E32-D21R**

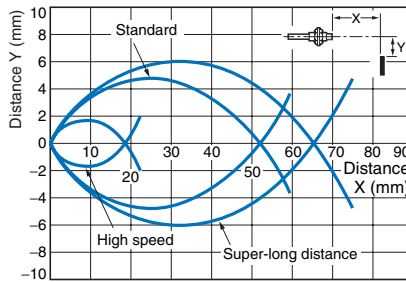

**Reflective**  
**E32-D22R**

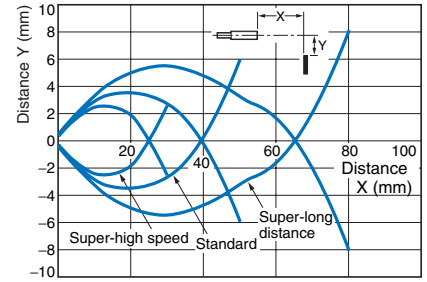

**Reflective**  
**E32-D33**

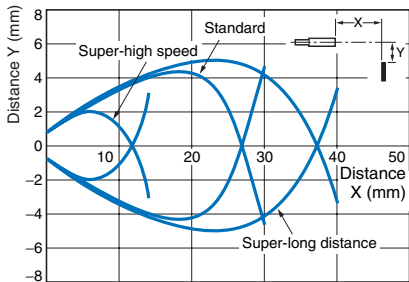

**Reflective**  
**E32-D331**

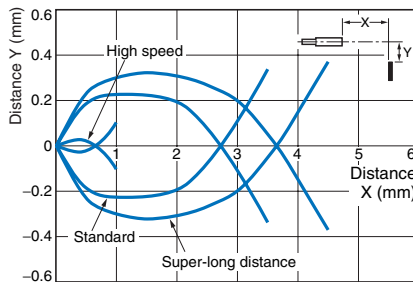

**Reflective**  
**E32-D21B**

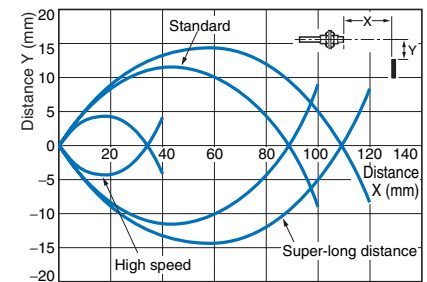

**Reflective**  
**E32-D22B**

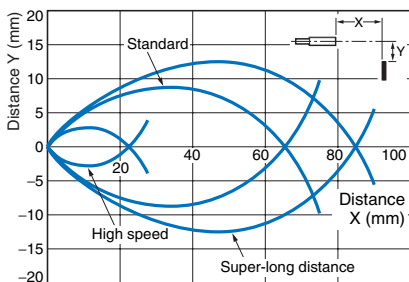

**Reflective**  
**E32-C31**

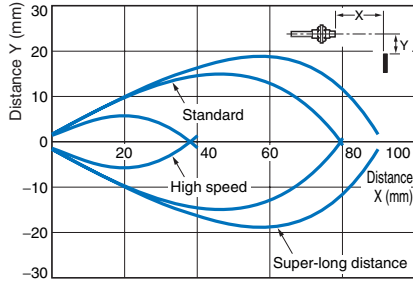

**Reflective**  
**E32-C41**

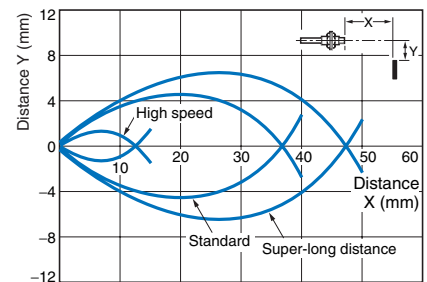

**Reflective  
E32-C42**

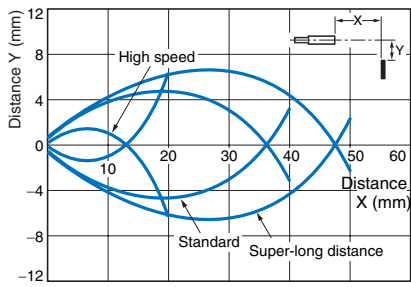

**Reflective  
E32-D32**

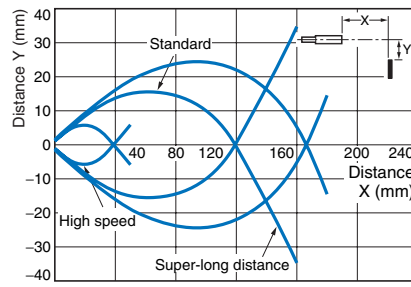

**Reflective  
E32-D14LR**

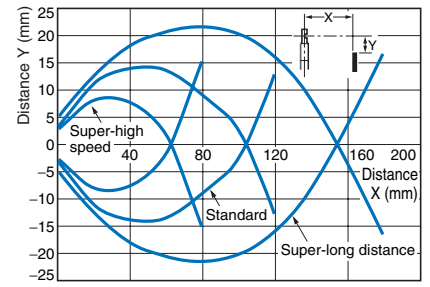

**Reflective  
E32-D24**

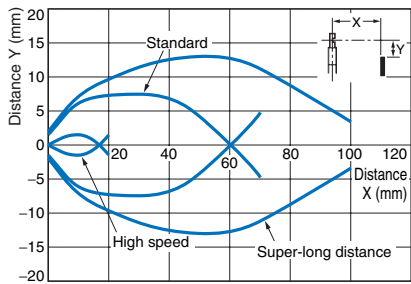

**Reflective  
E32-D24R**

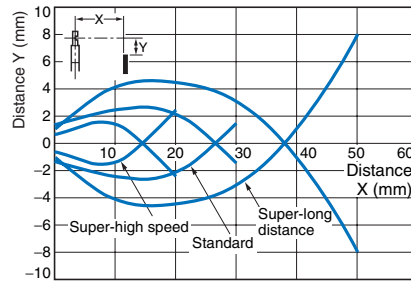

**Reflective  
E32-D61**

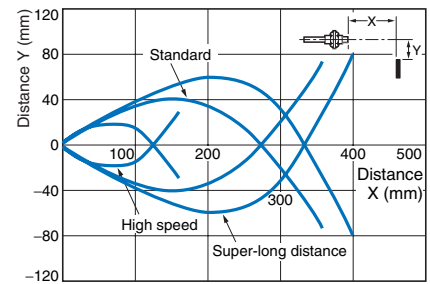

**Reflective  
E32-D36P1**

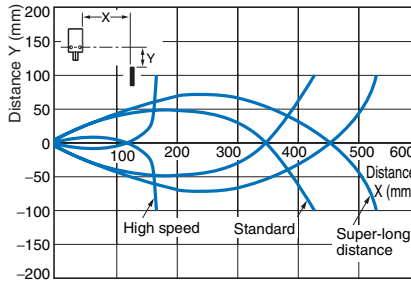

**Reflective  
E32-D36P1**

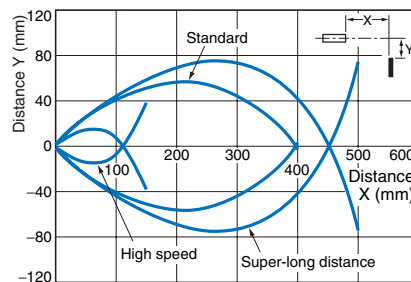

**Reflective  
E32-L56E**

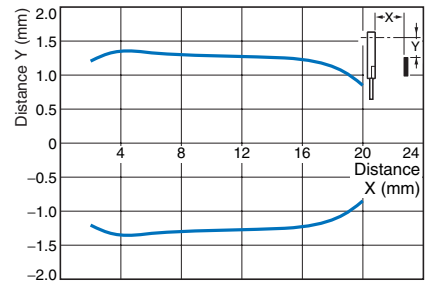

**Limited Reflective  
E32-L25L**

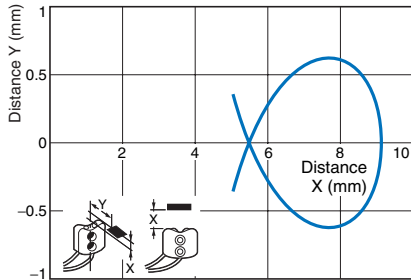

**Excess Gain Ratio vs. Distance** With standard sensing object at maximum sensitivity.

**Through-beam  
E32-TC200**

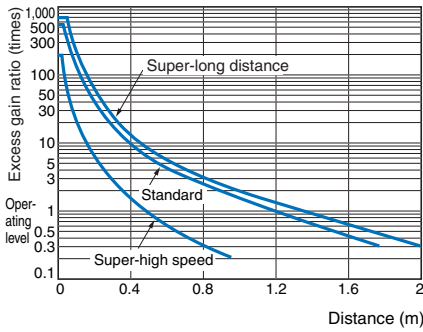

**Reflective  
E32-DC200**

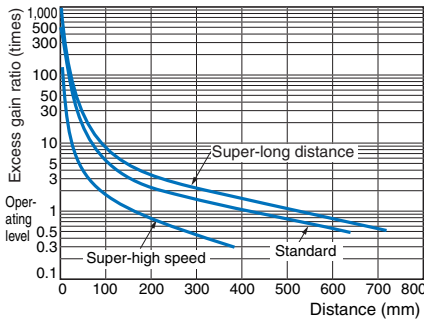

**Reflective  
E32-D21L**

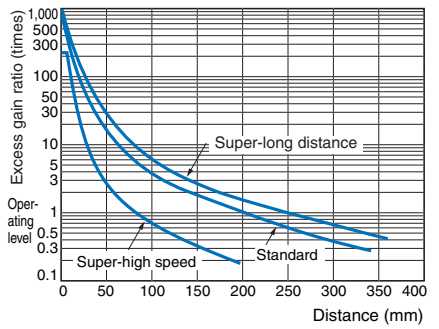

**Operating Range  
Reflective  
E32-DC200**

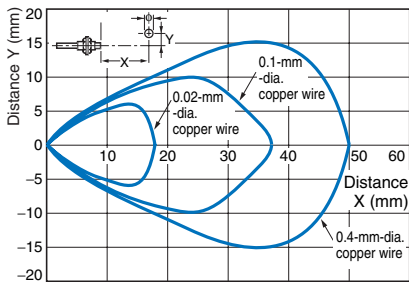

**Hysteresis vs. Sensing Distance  
Reflective  
E32-D11L**

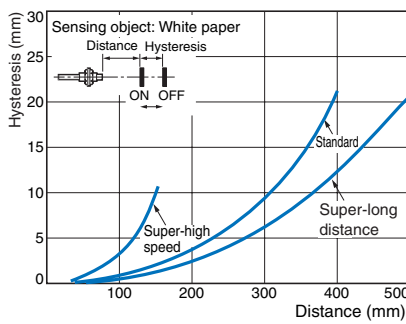

**Repeat Accuracy vs. Sensing Distance  
Reflective  
E32-DC200**

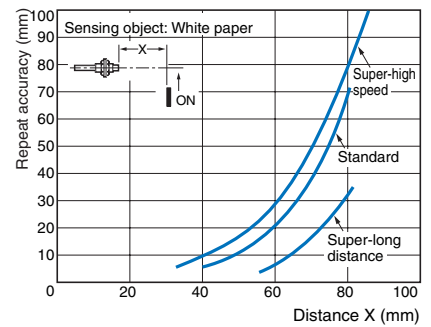

**E3X-DA-N**

**Monitor Output vs. Distance (Standard Mode)**

**Through-beam  
E32-TC200**

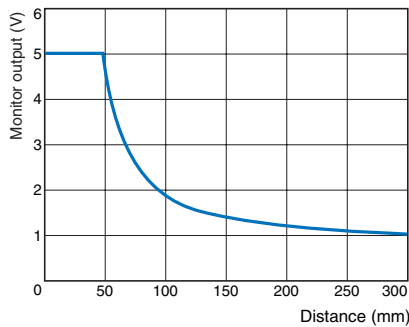

**Reflective  
E32-DC200**

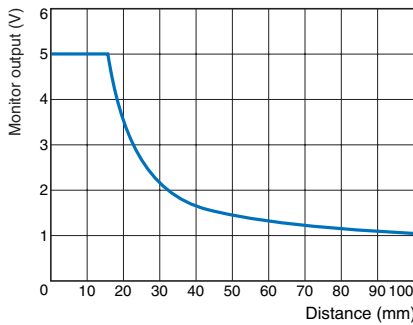

E3X-DAB-N/E3X-DAG-N

**Parallel Operating Range** At maximum sensitivity. (Use for optical axis adjustment at installation.)

**Through-beam**

**E32-TC200**

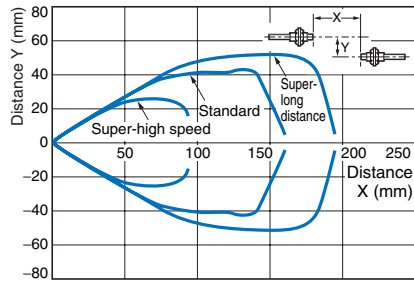

**Through-beam**

**E32-TC200 + E39-F1 (separately sold Long-distance Lens Unit)**

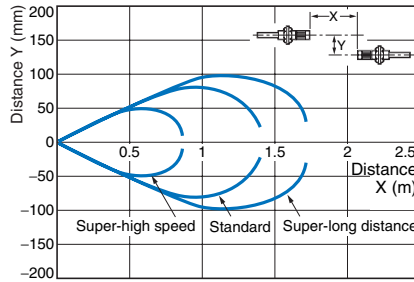

**Operating Range** With standard sensing object at maximum sensitivity. (Use for the positioning of the object and Sensor.)

**Reflective**

**E32-DC200**

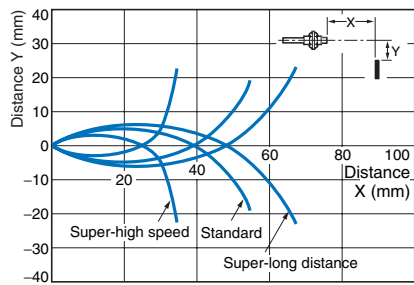

**Reflective**

**E32-CC200**

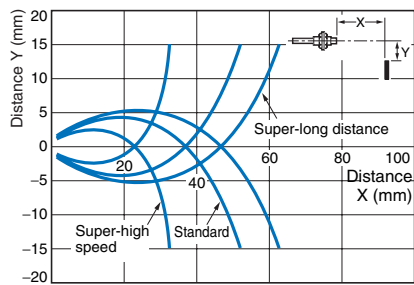

**Limited Reflective**

**E32-D11L**

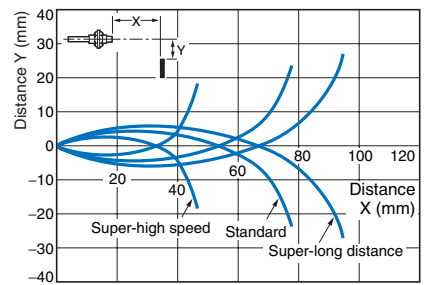

E3X-DAH-N

**Parallel Operating Range** At maximum sensitivity. (Use for optical axis adjustment at installation.)

**Through-beam**

**E32-TC200**

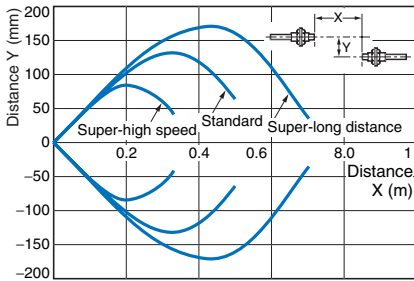

**Through-beam**

**E32-T11L**

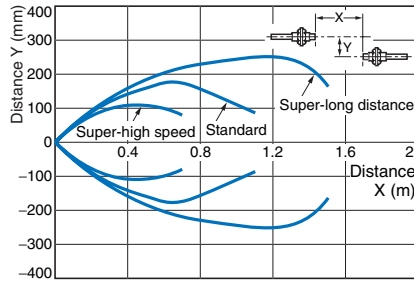

**Through-beam**

**E32-T14**

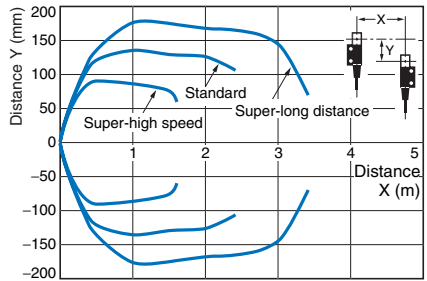

**Operating Range** With standard sensing object at maximum sensitivity. (Use for the positioning of the object and Sensor.)

**Reflective**

**E32-DC200**

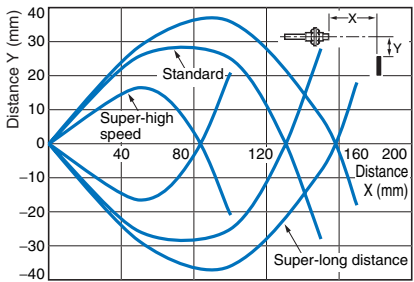

**Reflective**

**E32-D11L**

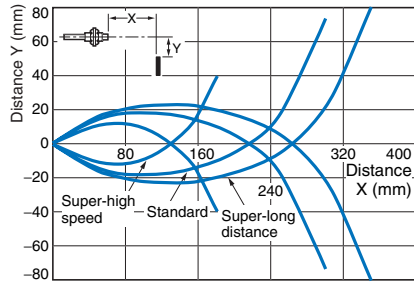

**Limited Reflective**

**E32-CC200**

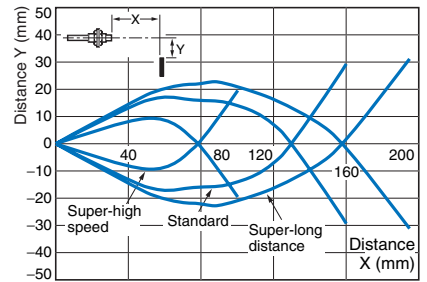

For other information on Fiber Units, refer to the Fiber Sensors Best Selection Catalog (Cat. No. E353).



Technical Reference (for E3X-DA-TW Twin-output Models)

(In the following examples, threshold 1 is set to 3,000, and threshold 2 is set to 1,000.)

Output Patterns for Normal Operation

Outputs 1 and 2 can be set to operate independently and either Light ON mode or Dark ON mode can be selected (independently) for channels 1 and 2 making a total of 4 possible output patterns.

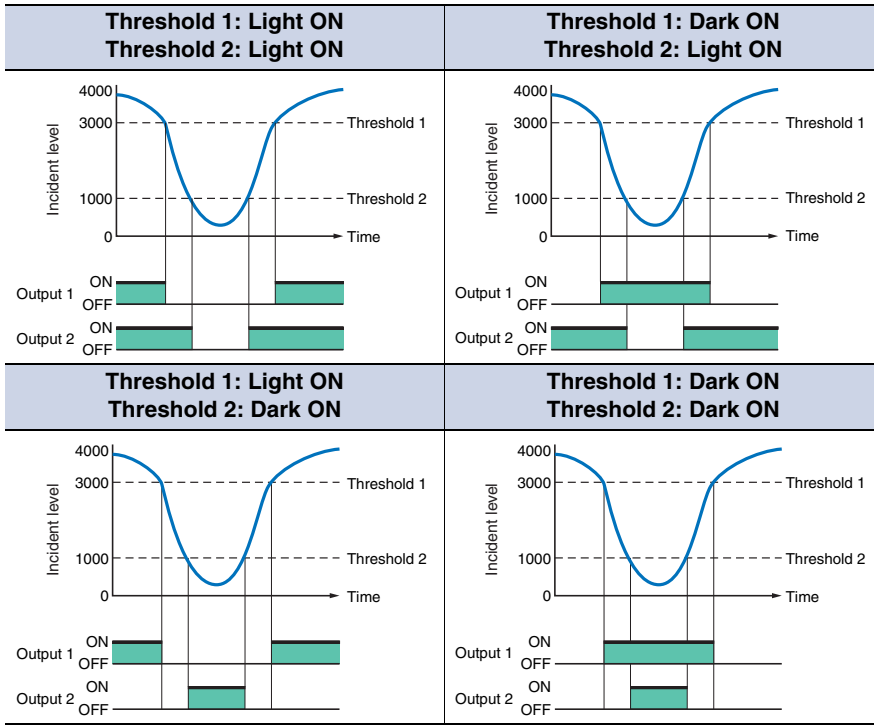

Output Patterns for Area Sensing

This series includes models equipped with area sensing functionality, a first for Digital Fiber Amplifiers. This functionality can be used to monitor whether the incident level is inside or outside the threshold area. The 2 output patterns below are possible for this kind of operation.

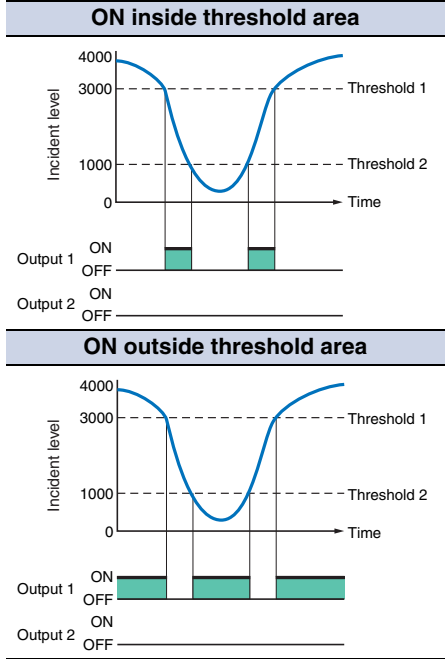

Note: Output 2 is always OFF.

## I/O Circuit Diagrams

### NPN Output

Model	Operation mode	Timing charts	Mode selector switch	Output circuit
E3X-DA11-N E3X-DAB11-N E3X-DAG11-N E3X-DAH11-N E3X-DA11V E3X-DA6 E3X-DAB6 E3X-DAG6 E3X-DAH6 E3X-DA14V	Light-ON		L-ON (LIGHT ON)	
	Dark-ON		D-ON (DARK ON)	<p>• Connector Pin Arrangement (M-8 Connector only) Note: Pin 2 is not used.</p>
E3X-DA21-N E3X-DA7	Light-ON		L-ON (LIGHT ON)	
	Dark-ON		D-ON (DARK ON)	<p>* Load resistance: 10 kΩ min.</p>
E3X-DA11TW E3X-DA6TW	Light-ON		L-ON (LIGHT ON)	
	Dark-ON		D-ON (DARK ON)	

Note: With E3X-DA□TW models, only channel 1 is output when set for area sensing operation.  
 LIGHT ON: ON when the incident level is between the thresholds for channels 1 and 2.  
 DARK ON: OFF when the incident level is between the thresholds for channels 1 and 2. (Channel 2 is always OFF.)

### Sensor I/O Connectors for Models with M8 Connectors

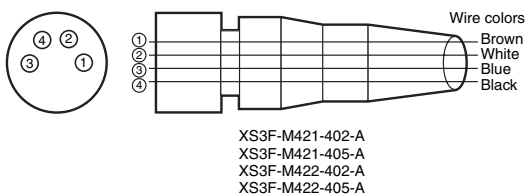

Classification	Wire colors	Connection pin No.	Application
DC	Brown	1	Power supply (+V)
	White	2	---
	Blue	3	Power supply (0 V)
	Black	4	Output

Note: Pin 2 is not used.

## PNP Output

Model	Operation mode	Timing charts	Mode selection switch	Output circuit
E3X-DA41-N E3X-DAB41-N E3X-DAG41-N E3X-DAH41-N E3X-DA41V E3X-DA8 E3X-DAB8 E3X-DAG8 E3X-DAH8 E3X-DA44V	Light-ON		L-ON (LIGHT ON)	
	Dark-ON		D-ON (DARK ON)	<p>• Connector Pin Arrangement (M-8 Connector only) Note: Pin 2 is not used.</p>
E3X-DA51-N E3X-DA9	Light-ON		L-ON (LIGHT ON)	
	Dark-ON		D-ON (DARK ON)	<p>* Load resistance: 10 kΩ min.</p>
E3X-DA41TW E3X-DA8TW	Light-ON		L-ON (LIGHT ON)	
	Dark-ON		D-ON (DARK ON)	

Note: With E3X-DA□TW models, only channel 1 is output when set for area sensing operation.

LIGHT ON: ON when the incident level is between the thresholds for channels 1 and 2.

DARK ON: OFF when the incident level is between the thresholds for channels 1 and 2. (Channel 2 is always OFF.)

## Sensor I/O Connectors for Models with M8 Connectors

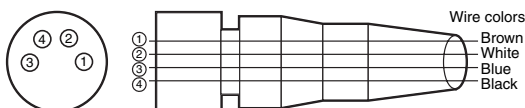

XS3F-M421-402-A  
XS3F-M421-405-A  
XS3F-M422-402-A  
XS3F-M422-405-A

Classification	Wire colors	Connection pin No.	Application
DC	Brown	1	Power supply (+V)
	White	2	---
	Blue	3	Power supply (0 V)
	Black	4	Output

Note: Pin 2 is not used.

Connection

Connection with K3NX-VD2 Process Meter

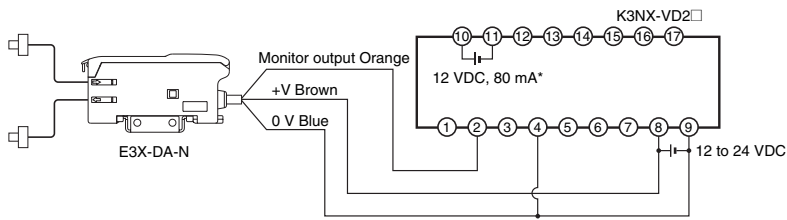

Note 1. Various I/O Units are available for the K3NX. Select an appropriate output type depending on the application.  
 2. This wiring is for the K3NX with DC power supply specifications and the Monitor (Analog) Sensor with DC power supply specifications. Check respective power supply specifications before wiring.  
 \* Use this service power supply for the Sensor with reference to the power consumption of each Sensor.

Nomenclature

Amplifiers

Standard, Monitor-output, Mark-detecting, Infrared, and Water-resistant Models

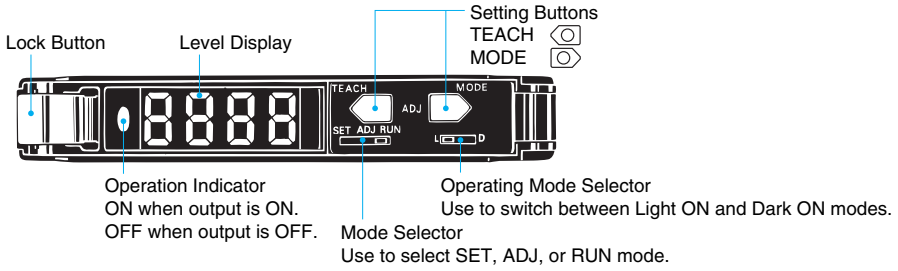

Twin-output Models

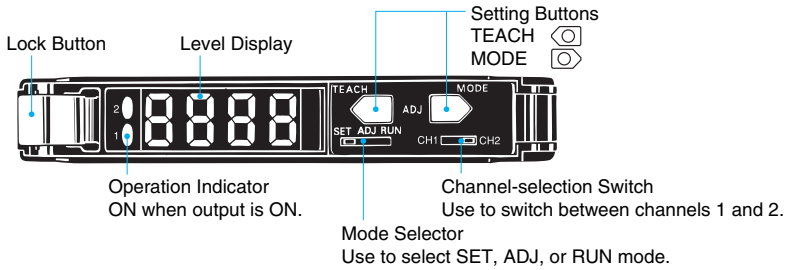

# Amplifier Adjustments

## All Models

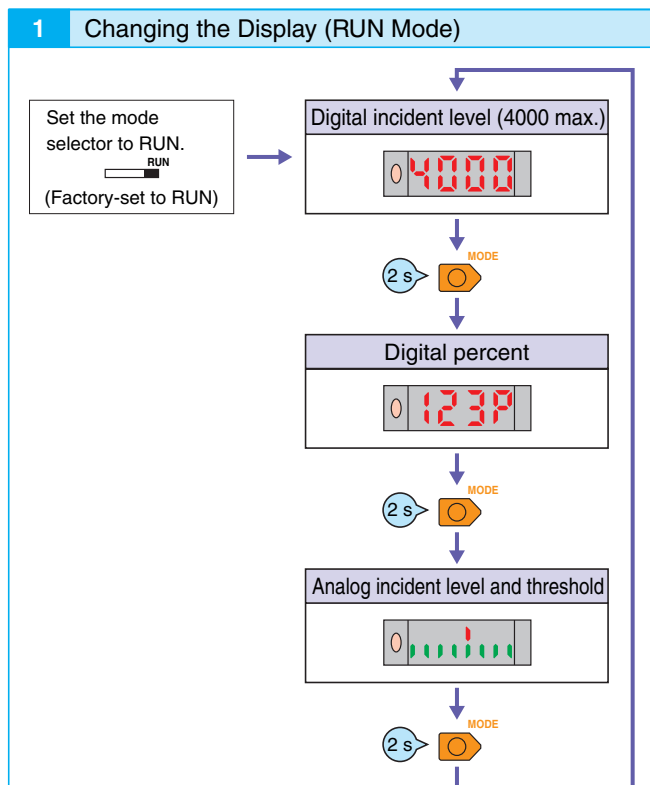

### Manual Tuning (Fine Sensitivity Adjustment) in ADJ Mode

Perform fine sensitivity adjustment after teaching and manual tuning (without using the teaching function) in the way shown below:

**Twin-output Models**  
 First, select the channel to be adjusted using the channel selection switch.  
 CH1  CH2

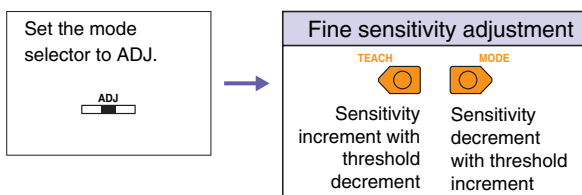

The items displayed in ADJ mode vary with the display setting in RUN mode.

RUN mode	ADJ mode
Digital incident level	Digital threshold
Digital percent	Digital percent
Analog value	Analog value

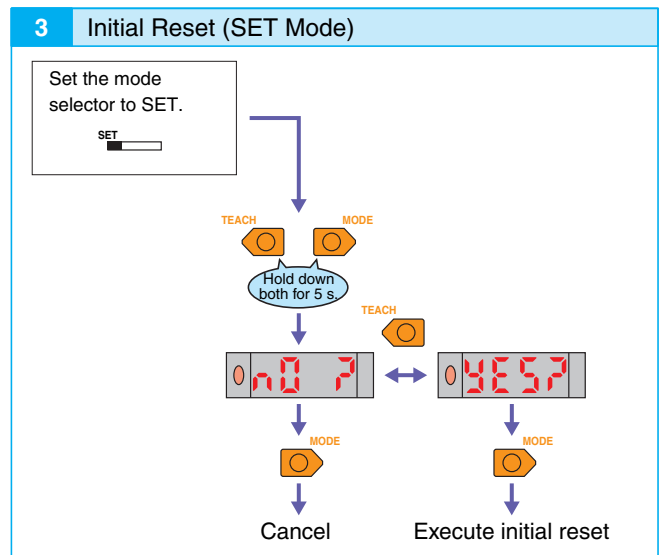
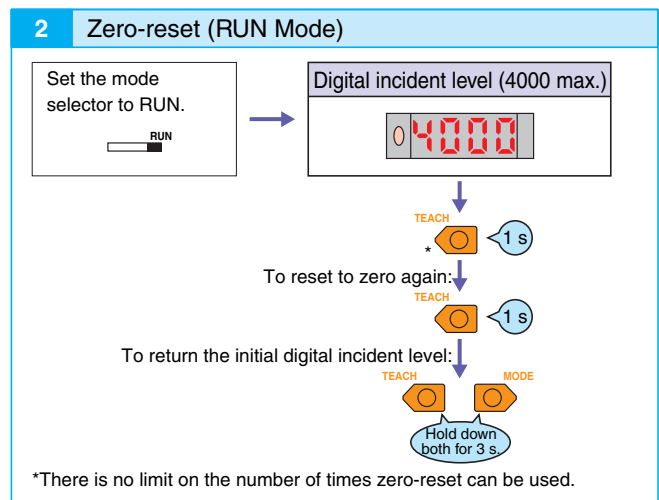

4 Setting Functions in SET Mode

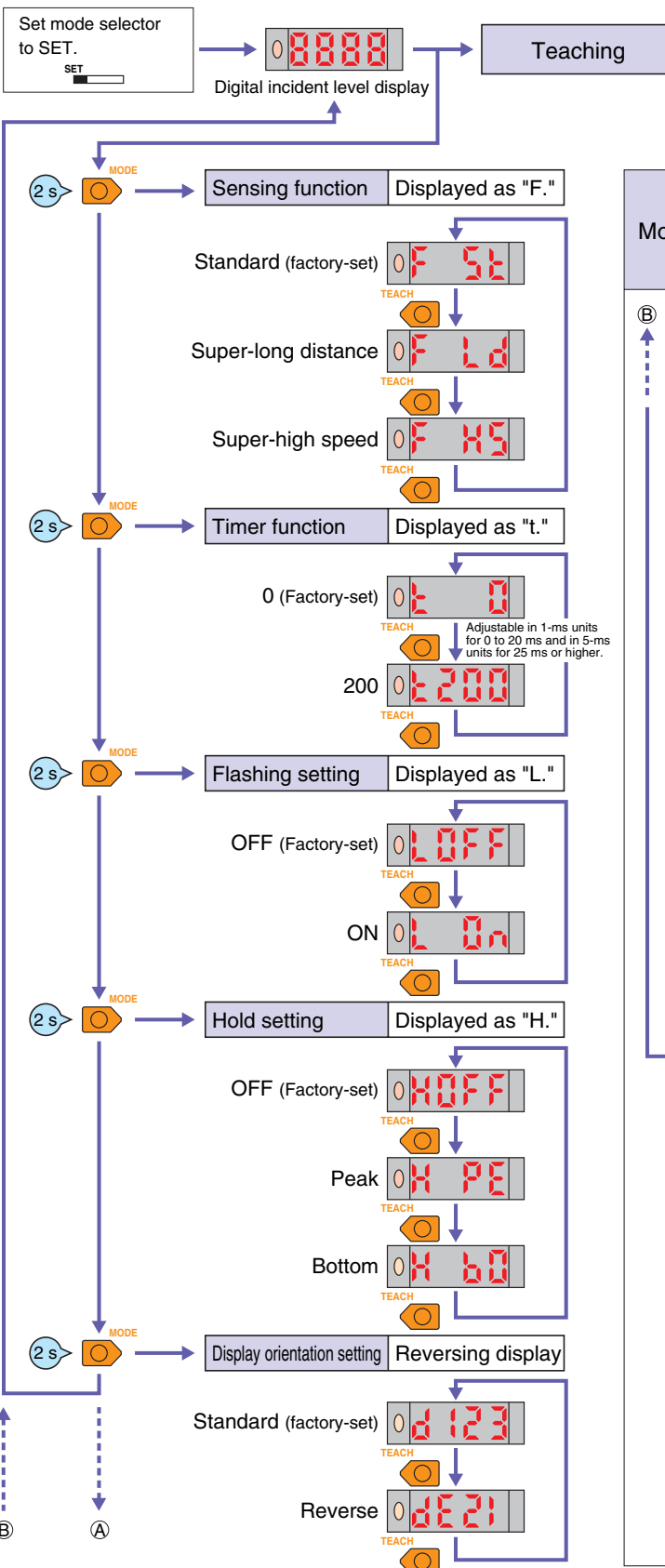

Four types of sensitivity settings are available. Refer to page 22 for details.

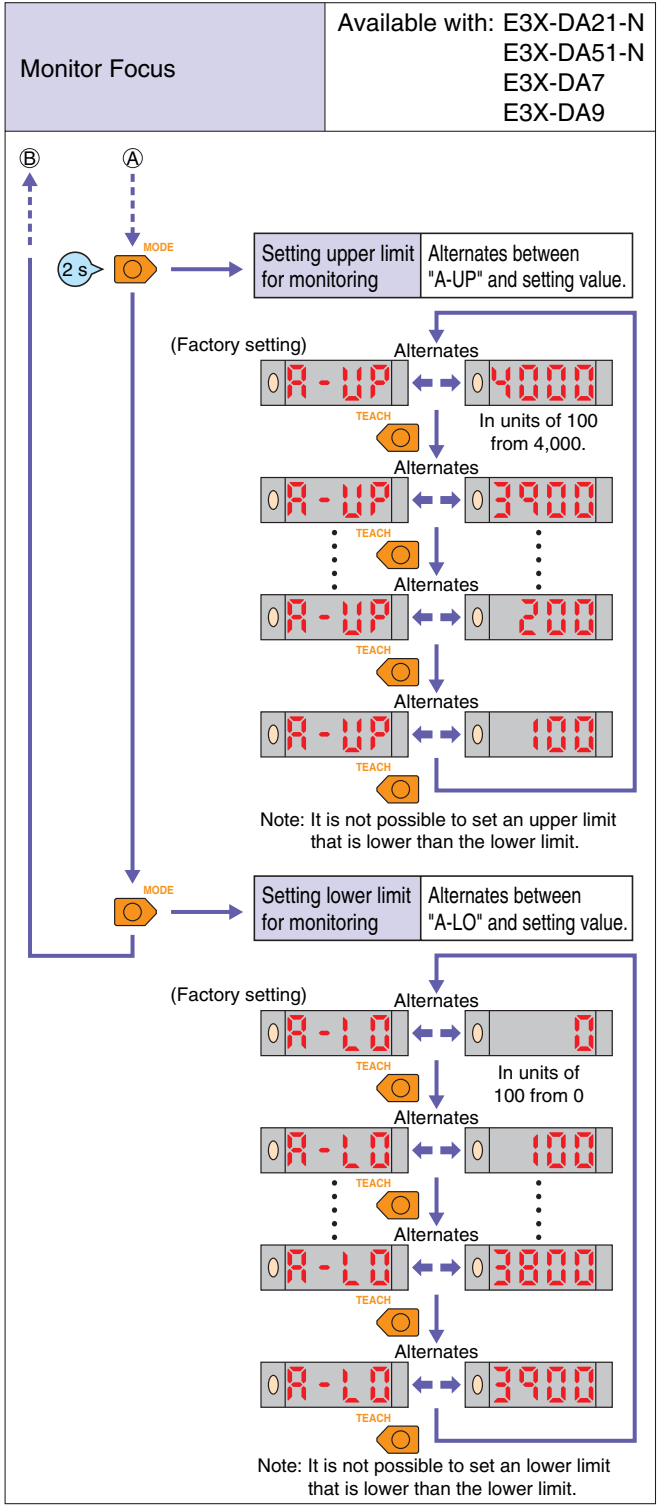



Twin-output Models

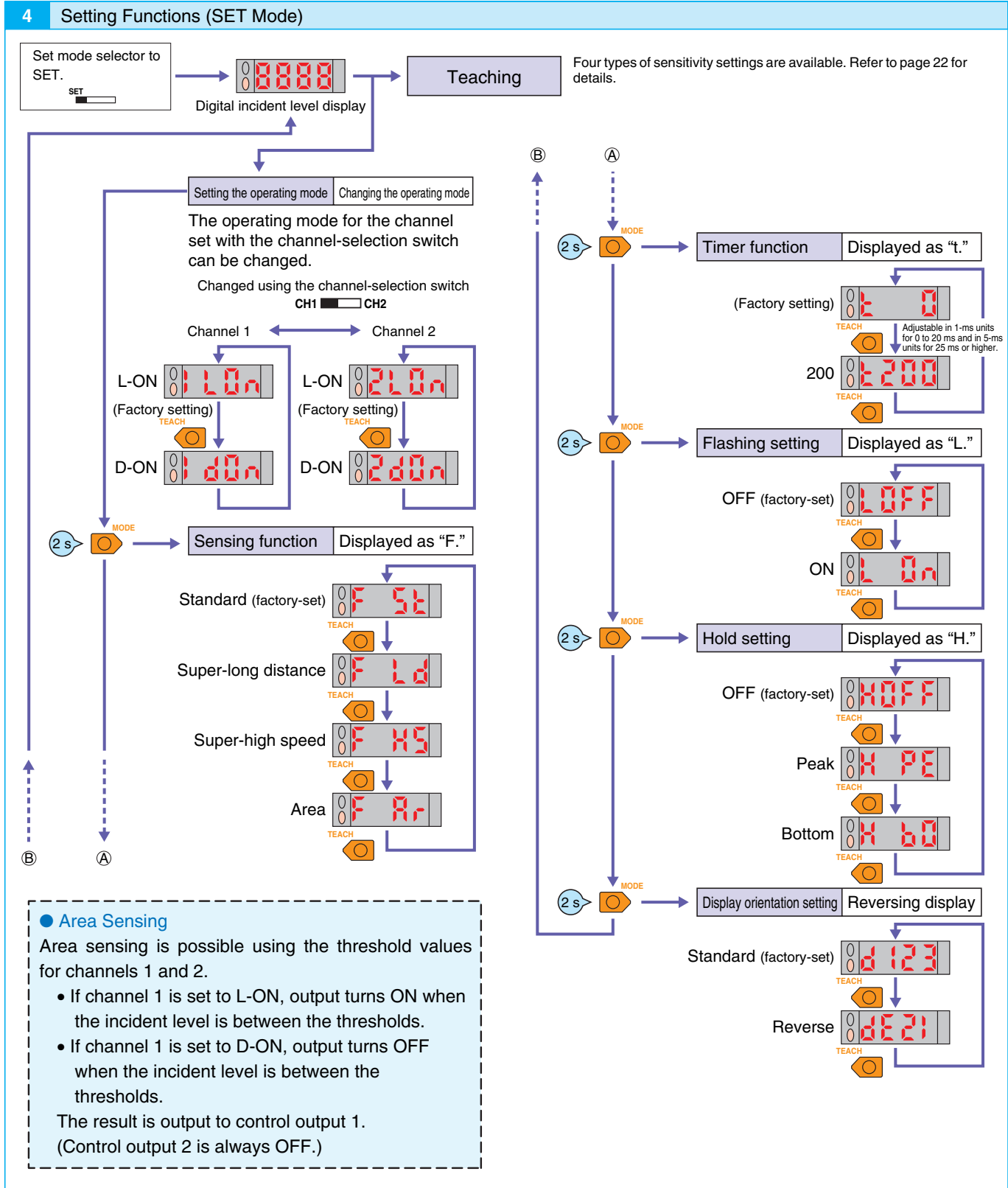

All Models





Teaching (SET Mode)

- The four types of teaching given below are available.
- Once the setting is made, the Amplifier operates according to the settings. The red level display will flash if a teaching error occurs. In that case, repeat the whole teaching procedure.

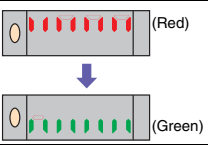

With twin-output models, switch to the channel to be adjusted using the channel-selection switch. CH1  CH2

Set the mode selector to SET to start teaching. 

Maximum Sensitivity Setting

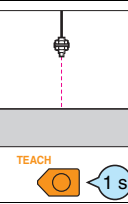

Step	Operation	
1	Set the mode selector to SET.	
2	Press the TEACH button for at least 3 seconds.	
3	Setting is complete when the level display changes from red to green. The level display will display the digital incident level later.	
4	Set to RUN mode.	

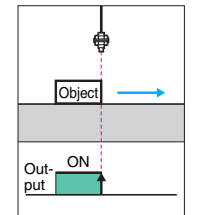
One-point Without-object Teaching

Step	Operation	
1	Set the mode selector to SET.	
2	Press the TEACH button for approximately 1 second.	
3	Teaching is complete when the red level display is lit. The level display will display the digital incident level later.	
4	Set to RUN mode.	
5	The threshold is automatically set with the object.	



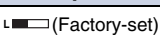

Note: If one-point teaching is not available because the difference in level is too fine, try two-point teaching.

Operating Mode Selector

Operating mode		Operation
Light-ON	L-ON	 (Factory-set)
Dark-ON	D-ON	

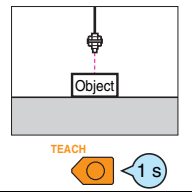

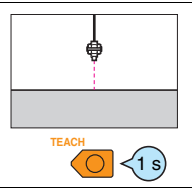

Note: There is no operating mode selector for twin-output models.

Two-point With/Without-object Teaching

Step	Operation	
1	Set the mode selector to SET.	
2	Press the TEACH button for approximately 1 second when the object is at the sensing position.	
3	The red level display is lit.	
4	Press the TEACH button for approximately 1 second with no object.	
5	Teaching is complete when the green level display is lit. The level display will display the digital incident level later.	
6	Set to RUN mode.	

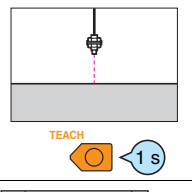
Note: The order of "with-object" and "without-object" setting steps above can be reversed.

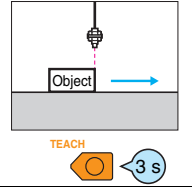
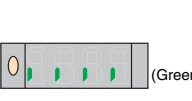
Pin-point Teaching (for Positioning)

Step	Operation	
1	Set the mode selector to SET.	
2	Press the TEACH button for approximately 1 second with no object.	
3	The red level display is lit.	
4	Place the object in the desired position, and press the TEACH button for at least 3 seconds.	
5	Teaching is complete when the green level display is lit. The level display will display the digital incident level later. (The red level display will flash if a teaching error occurs.)	
6	Set to RUN mode.	

## Safety Precautions

### WARNING

This product is not designed or rated for ensuring safety of persons. Do not use it for such purpose.



### Precautions for Correct Use

Do not use the product in atmospheres or environments that exceed product ratings.

## Amplifiers

### ● Designing

#### Operation after Turning Power ON

The Sensor is ready to detect within 200 ms after the power supply is turned ON. If the Sensor and load are connected to separate power supplies, be sure to turn ON the Sensor first.

### ● Mounting

#### Joining and Separating Amplifiers

##### Joining Amplifiers

(1) Mount the Amplifiers one at a time onto the DIN track.

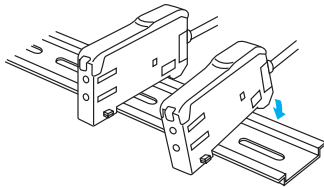

(2) Slide the Amplifiers together, line up the clips, and press the Amplifiers together until they click into place.

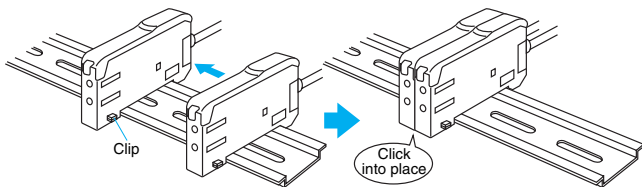

##### Separating Amplifiers

Slide Amplifiers away from each other, and remove from the DIN track one at a time. (Do not attempt to remove Amplifiers from the DIN track without separating them first.)

Note 1. The specifications for ambient temperature will vary according to the number of Amplifiers used together. For details, refer to *Ratings and Specifications*.  
2. Always turn OFF the power supply before joining or separating Amplifiers.

## Fiber Connection and Disconnection

The E3X Amplifier uses a one-touch locking mechanism. (Only the E3X-NM uses a locking button mechanism.) Connect or disconnect the fibers to or from the E3X Amplifier using the following procedures:

### (1) Connection

Open the protective cover, insert the fibers according to the fiber insertion marks on the side of the Amplifier, and lower the lock button.

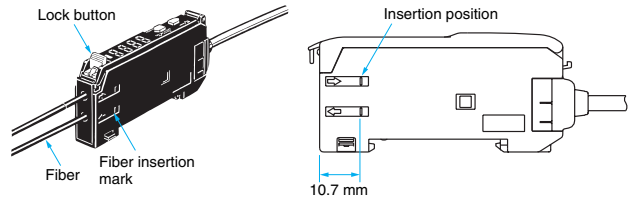

### (2) Disconnection

Remove the protective cover and raise the lock button to pull out the fiber.

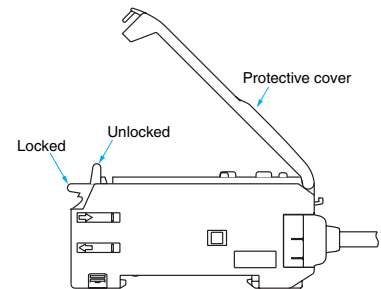

**Note: To maintain the fiber properties, confirm that the lock is released before removing the fiber.**

### (3) Precautions for Fiber Connection/Disconnection

Be sure to lock or unlock the lock button within an ambient temperature range between  $-10$  and  $40^{\circ}\text{C}$ .

### Mounting the Mobile Console Head

Leave a gap of at least 20 mm between the nearest Amplifier and the Mobile Console head.

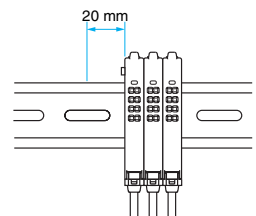

### Mounting the Mobile Console Head

With Twin-output models (E3X-DA□□TW), up to 16 channels (i.e., eight E3X-DA□□TW Amplifiers) can be set using the E3X-MC11 Mobile Console. (Operating modes and area detection, however, cannot be set.)

### ● Adjustment

#### Mutual Interference Protection Function

There may be some instability in the digital display values due to light from other sensors. If this occurs, decrease the sensitivity (i.e., increase the threshold) to perform stable detection.

#### EEPROM Writing Error

If the data is not written to the EEPROM correctly due to a power failure during teaching or static-electric noise, repeat the whole teaching procedure.

## Optical Communications

Several Amplifiers can be slid together and used in groups. Do not, however, slide the Amplifiers or attempt to remove any of the Amplifiers during operation.

## Hysteresis Adjustment

The hysteresis setting can be adjusted using the Mobile Console. Do not, however, set the hysteresis to a value lower than the factory setting. Using a setting less than the factory setting may result in incorrect operation.

## Amplifiers with Connectors

### ● Mounting

#### Mounting Connectors

- (1) Insert the Master or Slave Connector into the Amplifier until it clicks into place.

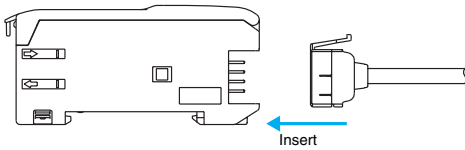

- (2) Join Amplifiers together as required after all the Master and Slave Connectors have been inserted.
- (3) Attach the stickers (provided as accessories) to the sides of Master and Slave Connectors that are not connected to other Connectors.

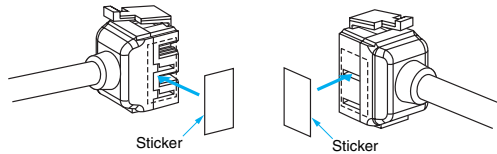

Note: Attach the stickers to the sides with grooves.

#### Removing Connectors

- (1) Slide the slave Amplifier(s) for which the Connector is to be removed away from the rest of the group.
- (2) After the Amplifier(s) has been separated, press down on the lever on the Connector and remove it. (Do not attempt to remove Connectors without separating them from other Amplifiers first.)

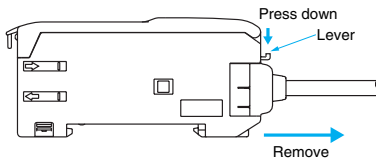

#### Mounting End Plate (PFP-M)

Depending on how it is mounted, an Amplifier may move during operation. In this case, use an End Plate. Before mounting an End Plate, remove the clip from the master Amplifier using a nipper or similar tool.

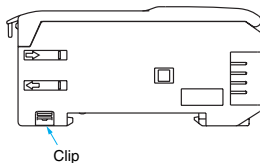

The clip can also be removed using the following mechanism, which is incorporated in the construction of the section underneath the clip.

- (1) Insert the clip to be removed into the slit underneath the clip on another Amplifier.

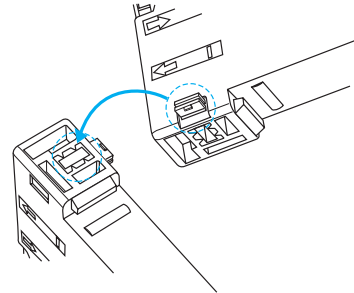

- (2) Remove the clip by rotating the Amplifier.

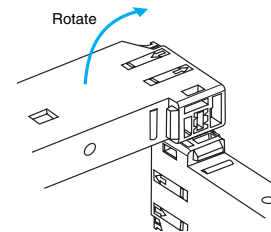

When using the E3X-DA-N with the Mobile Console, mount the End Plate in the way shown below.

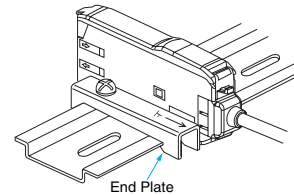

#### Pull Strengths for Connectors (Including Cables)

E3X-CN11, E3X-CN21, E3X-CN22: 30 N max.  
E3X-CN12: 12 N max.

Accessories

Operating Instructions Sticker E39-Y1

- Attach near the Sensor.
- 1 English and 1 Japanese sticker per set
- Material: Front side: Paper, Reverse side: Adhesive tape

Japanese Sticker

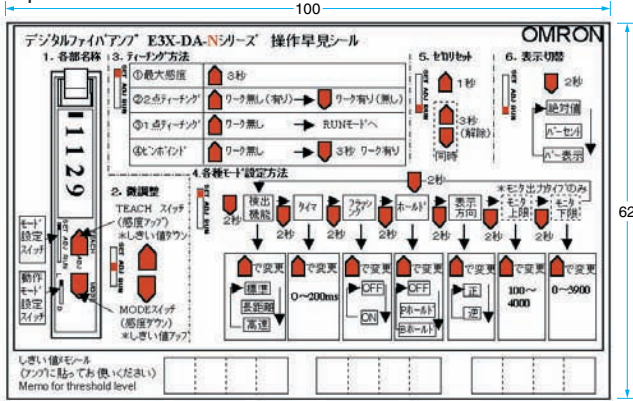

English Sticker

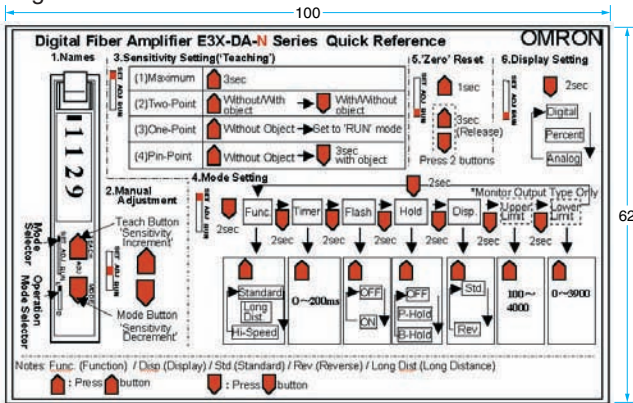

## Dimensions

Unless otherwise specified, the tolerance class IT16 is used for dimensions in this data sheet.

### Pre-wired Amplifiers

- |             |             |
|-------------|-------------|
| E3X-DA11-N  | E3X-DAG11-N |
| E3X-DA21-N  | E3X-DAH11-N |
| E3X-DAB11-N | E3X-DAB41-N |
| E3X-DA41-N  | E3X-DAG41-N |
| E3X-DA51-N  | E3X-DAH41-N |
| E3X-DA11D   |             |

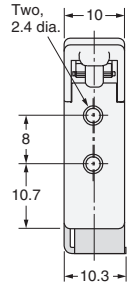
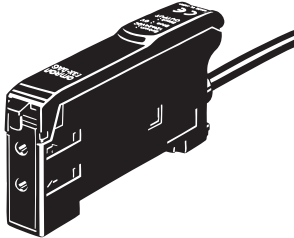

### With Mounting Bracket Attached

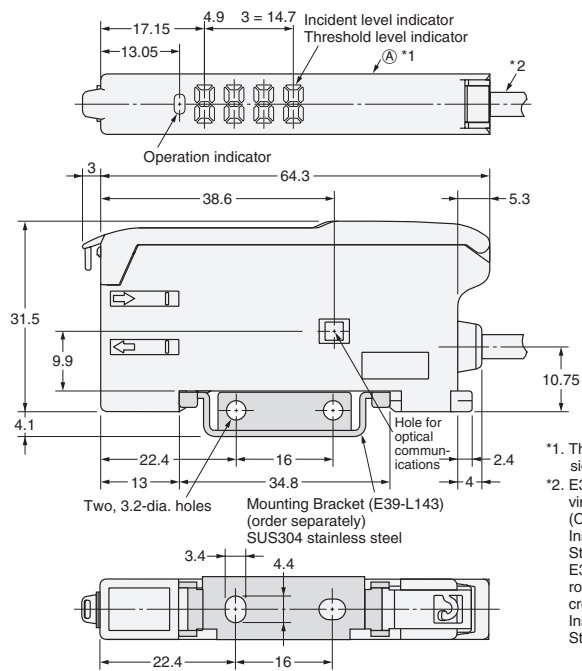

### Mounting Holes

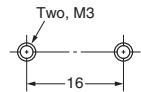

- \*1. The Mounting Bracket can also be used on side A.
- \*2. E3X-DA11-N/DA41-N/DAB11-N: 4-dia. vinyl-insulated round cable with 3 conductors (Conductor cross section: 0.2 mm<sup>2</sup>; Insulation diameter: 1.1 mm). Standard length: 2 m.  
E3X-DA21-N/DA51-N: 4-dia. vinyl-insulated round cable with 4 conductors (Conductor cross section: 0.2 mm<sup>2</sup>; Insulation diameter: 1.1 mm). Standard length: 2 m.

Note: When using E39-L143 Mounting Brackets, there will be small gaps between the Amplifier Units if they are mounted side by side.

### Pre-wired Amplifiers, Water-resistant Models

- E3X-DA11V  
E3X-DA41V

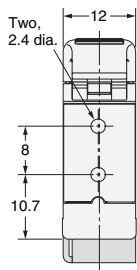
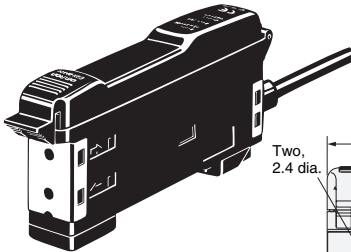

### Mounting Holes

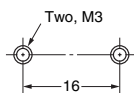

### With Mounting Bracket Attached

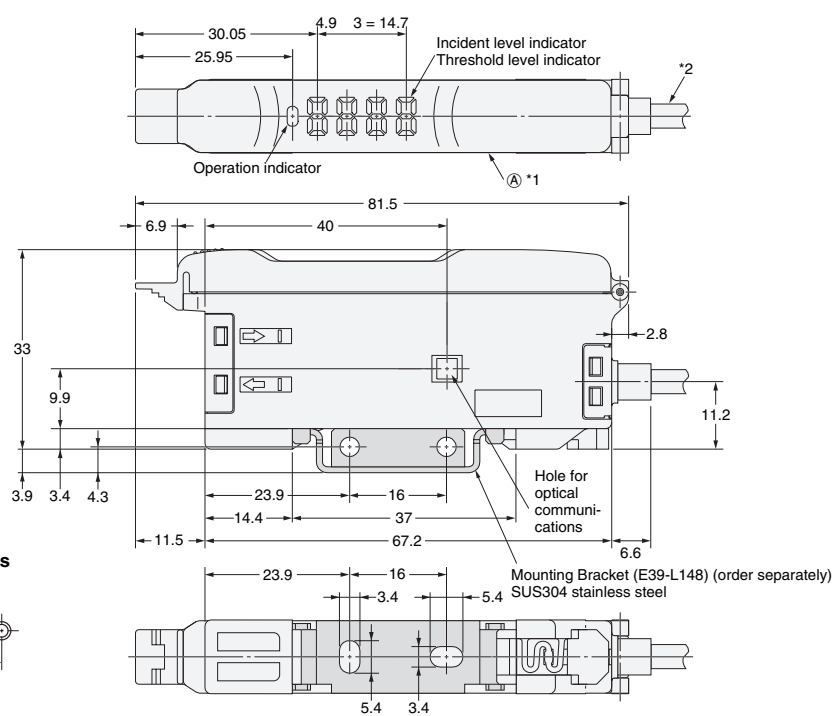

- \*1. The Mounting Bracket can also be used on side A.
- \*2. 4-dia. vinyl-insulated round cable with 3 conductors (Conductor cross section: 0.2 mm<sup>2</sup>; Insulation diameter: 1.1 mm). Standard length: 2 m.



## Pre-wired Amplifiers, Twin-output Models

E3X-DA11TW

E3X-DA41TW

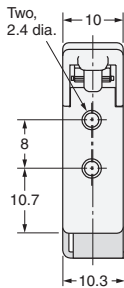
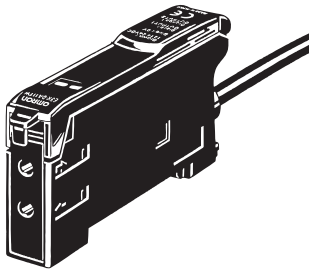

### With Mounting Bracket Attached

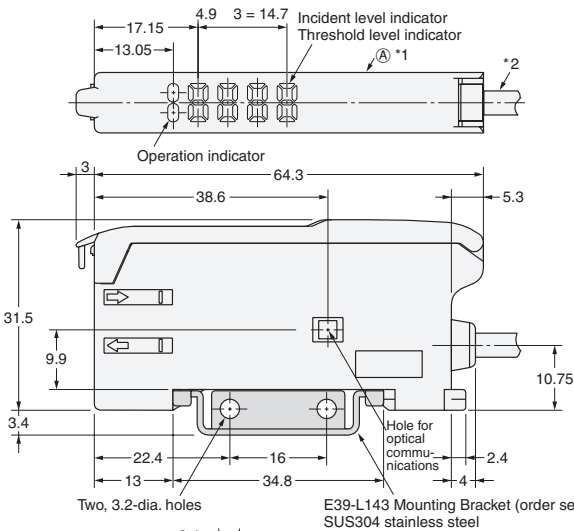

### Mounting Holes

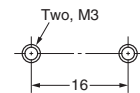

Note: When using E39-L143 Mounting Brackets, there will be small gaps between the Amplifier Units if they are mounted side by side.

\*1. The Mounting Bracket can also be used on side A.  
\*2. 4-dia. vinyl-insulated round cable with 4 conductors (Conductor cross section: 0.2 mm<sup>2</sup>; Insulation diameter: 1.1 mm). Standard length: 2 m.

## Amplifiers with Standard Connectors

- E3X-DA6      E3X-DAG6
- E3X-DA7      E3X-DAH6
- E3X-DA8      E3X-DAB8
- E3X-DA9      E3X-DAG8
- E3X-DAB6    E3X-DAH8
- E3X-DA6D    E3X-DA6-P

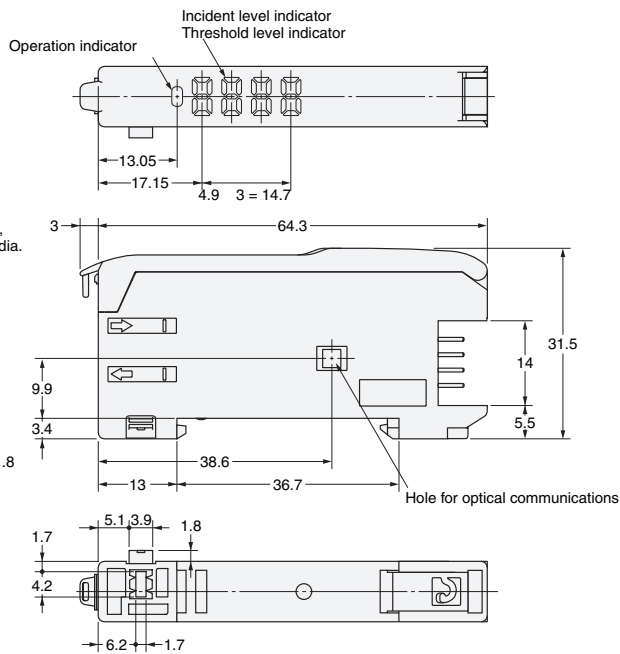
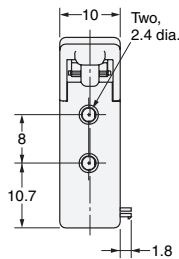
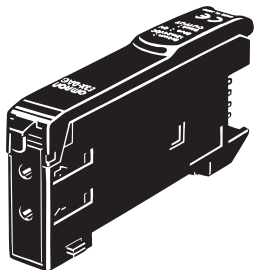

### Dimensions with Master Connector Connected

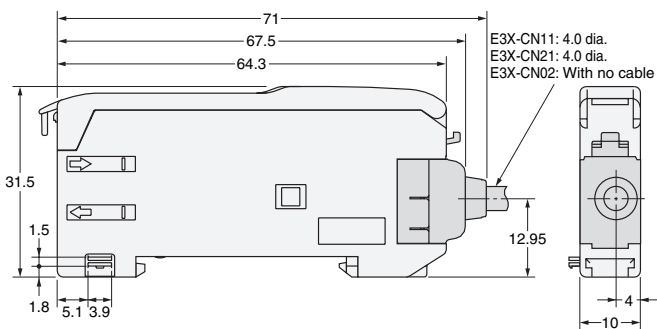

### Dimensions with Slave Connector Connected

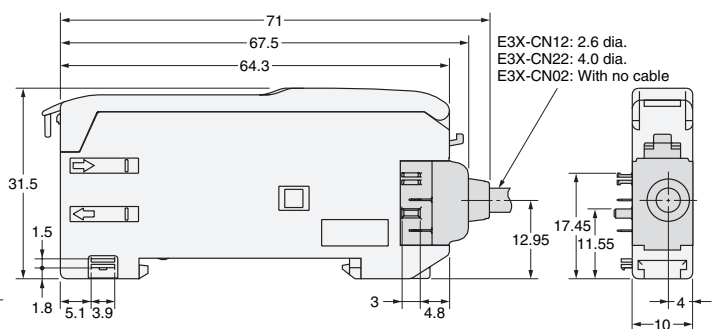

## Amplifiers with M8 Connectors, Water-resistant Models

**E3X-DA14V**  
**E3X-DA44V**

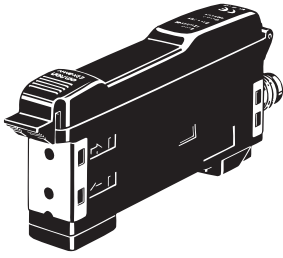

\*The Mounting Bracket can also be used on side A.

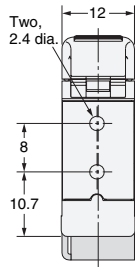

### Mounting Holes

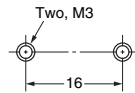

### With Mounting Bracket Attached

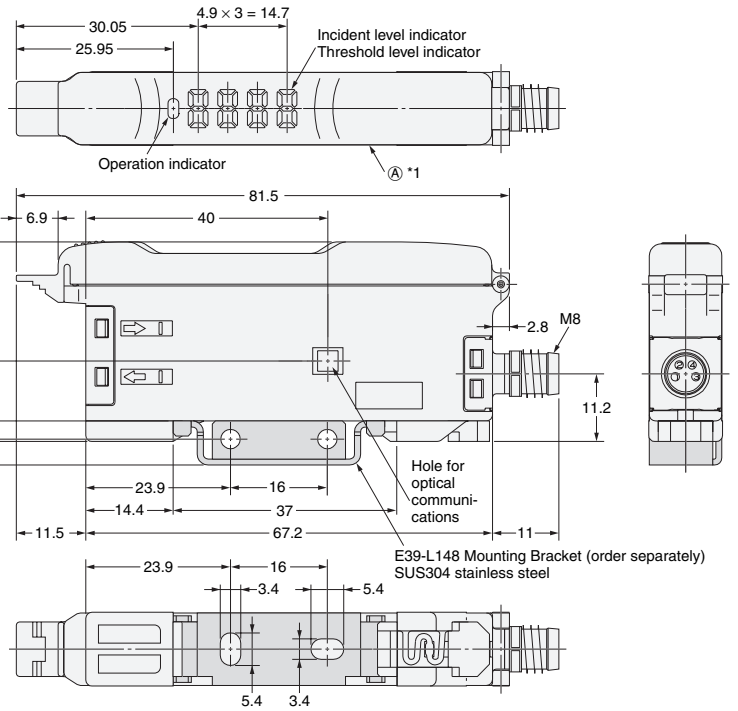

## Amplifiers with Standard Connectors, Twin-output Models

**E3X-DA6TW**  
**E3X-DA8TW**

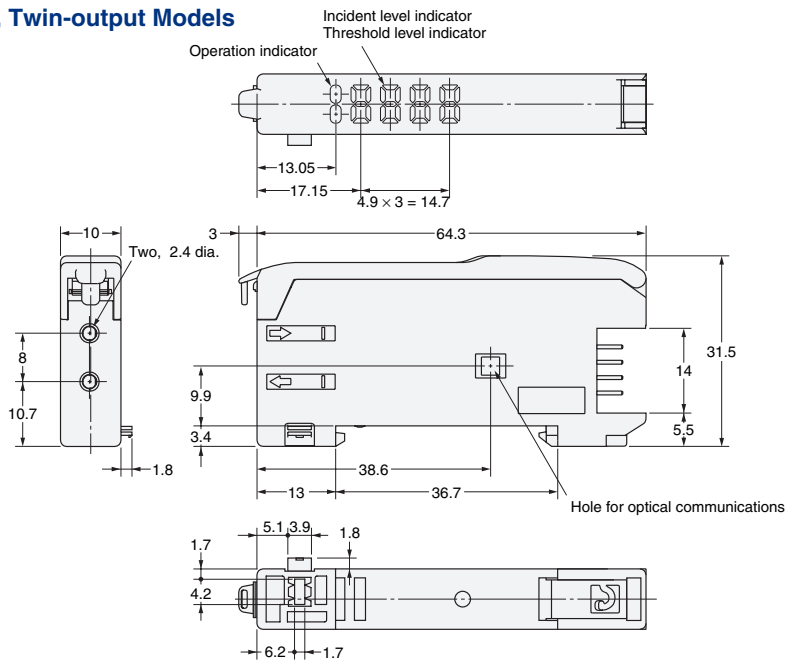
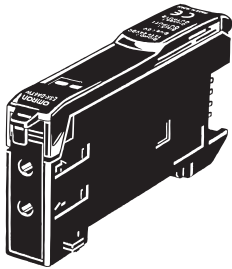

### Dimensions with Master Connector Connected

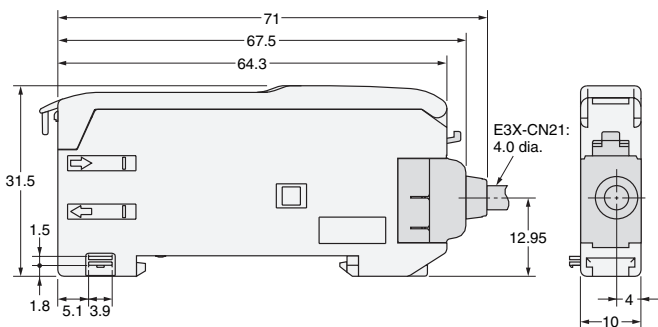

### Dimensions with Slave Connector Connected

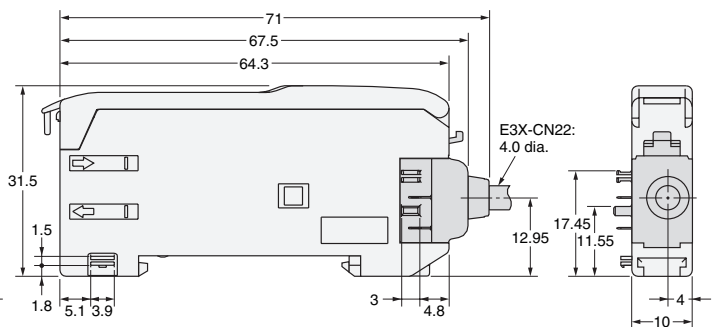

## Amplifiers with Connectors

### Master Connectors

E3X-CN11  
E3X-CN21

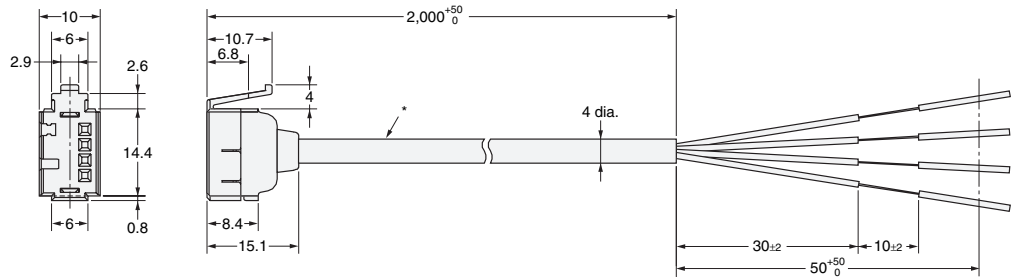
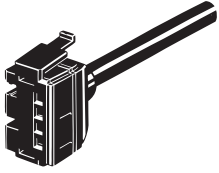

\* E3X-CN11: 4-dia. vinyl-insulated round cable with 3 conductors (Conductor cross section: 0.2 mm<sup>2</sup>; Insulation diameter: 1.1 mm).  
E3X-CN21: 4-dia. vinyl-insulated round cable with 4 conductors (Conductor cross section: 0.2 mm<sup>2</sup>; Insulation diameter: 1.1 mm).

### Slave Connectors

E3X-CN12  
E3X-CN22

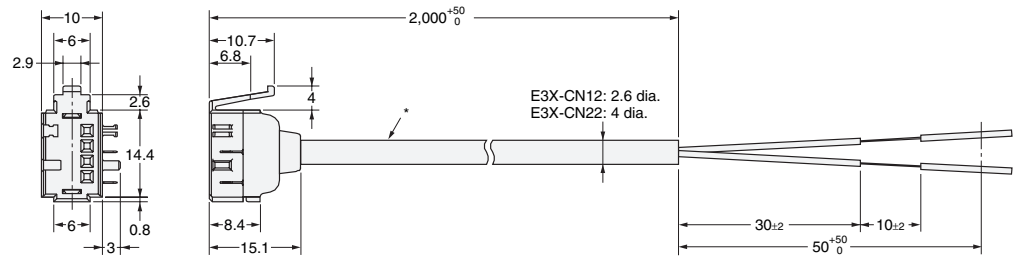
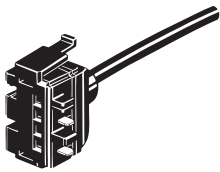

\* E3X-CN12: 2.6-dia. vinyl-insulated round cable with 1 conductor (Conductor cross section: 0.2 mm<sup>2</sup>; Insulation diameter: 1.1 mm).  
E3X-CN22: 4-dia. vinyl-insulated round cable with 2 conductors (Conductor cross section: 0.2 mm<sup>2</sup>; Insulation diameter: 1.1 mm).

## Mobile Console

E3X-MC11



### Mobile Console

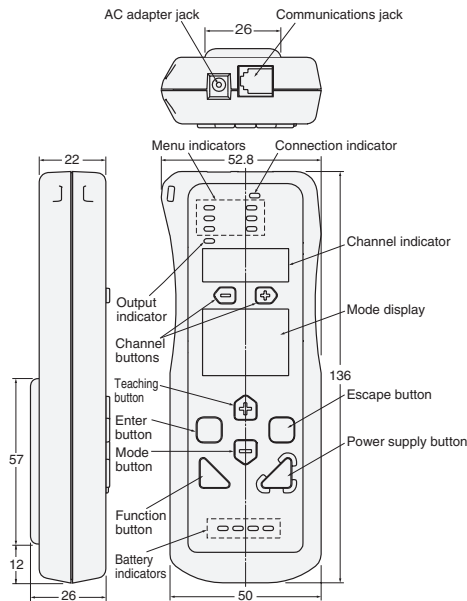

### Mobile Console Head

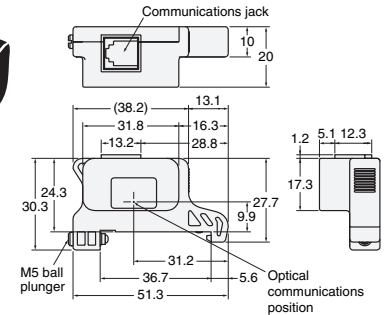

## Accessories (Order Separately)

Mounting Brackets  
End Plate

In the interest of product improvement, specifications are subject to change without notice.

## Terms and Conditions Agreement

### Read and understand this catalog.

Please read and understand this catalog before purchasing the products. Please consult your OMRON representative if you have any questions or comments.

### Warranties.

(a) Exclusive Warranty. Omron's exclusive warranty is that the Products will be free from defects in materials and workmanship for a period of twelve months from the date of sale by Omron (or such other period expressed in writing by Omron). Omron disclaims all other warranties, express or implied.

(b) Limitations. OMRON MAKES NO WARRANTY OR REPRESENTATION, EXPRESS OR IMPLIED, ABOUT NON-INFRINGEMENT, MERCHANTABILITY OR FITNESS FOR A PARTICULAR PURPOSE OF THE PRODUCTS. BUYER ACKNOWLEDGES THAT IT ALONE HAS DETERMINED THAT THE PRODUCTS WILL SUITABLY MEET THE REQUIREMENTS OF THEIR INTENDED USE.

Omron further disclaims all warranties and responsibility of any type for claims or expenses based on infringement by the Products or otherwise of any intellectual property right. (c) Buyer Remedy. Omron's sole obligation hereunder shall be, at Omron's election, to (i) replace (in the form originally shipped with Buyer responsible for labor charges for removal or replacement thereof) the non-complying Product, (ii) repair the non-complying Product, or (iii) repay or credit Buyer an amount equal to the purchase price of the non-complying Product; provided that in no event shall Omron be responsible for warranty, repair, indemnity or any other claims or expenses regarding the Products unless Omron's analysis confirms that the Products were properly handled, stored, installed and maintained and not subject to contamination, abuse, misuse or inappropriate modification. Return of any Products by Buyer must be approved in writing by Omron before shipment. Omron Companies shall not be liable for the suitability or unsuitability or the results from the use of Products in combination with any electrical or electronic components, circuits, system assemblies or any other materials or substances or environments. Any advice, recommendations or information given orally or in writing, are not to be construed as an amendment or addition to the above warranty.

See <http://www.omron.com/global/> or contact your Omron representative for published information.

### Limitation on Liability; Etc.

OMRON COMPANIES SHALL NOT BE LIABLE FOR SPECIAL, INDIRECT, INCIDENTAL, OR CONSEQUENTIAL DAMAGES, LOSS OF PROFITS OR PRODUCTION OR COMMERCIAL LOSS IN ANY WAY CONNECTED WITH THE PRODUCTS, WHETHER SUCH CLAIM IS BASED IN CONTRACT, WARRANTY, NEGLIGENCE OR STRICT LIABILITY.

Further, in no event shall liability of Omron Companies exceed the individual price of the Product on which liability is asserted.

### Suitability of Use.

Omron Companies shall not be responsible for conformity with any standards, codes or regulations which apply to the combination of the Product in the Buyer's application or use of the Product. At Buyer's request, Omron will provide applicable third party certification documents identifying ratings and limitations of use which apply to the Product. This information by itself is not sufficient for a complete determination of the suitability of the Product in combination with the end product, machine, system, or other application or use. Buyer shall be solely responsible for determining appropriateness of the particular Product with respect to Buyer's application, product or system. Buyer shall take application responsibility in all cases.

NEVER USE THE PRODUCT FOR AN APPLICATION INVOLVING SERIOUS RISK TO LIFE OR PROPERTY OR IN LARGE QUANTITIES WITHOUT ENSURING THAT THE SYSTEM AS A WHOLE HAS BEEN DESIGNED TO ADDRESS THE RISKS, AND THAT THE OMRON PRODUCT(S) IS PROPERLY RATED AND INSTALLED FOR THE INTENDED USE WITHIN THE OVERALL EQUIPMENT OR SYSTEM.

### Programmable Products.

Omron Companies shall not be responsible for the user's programming of a programmable Product, or any consequence thereof.

### Performance Data.

Data presented in Omron Company websites, catalogs and other materials is provided as a guide for the user in determining suitability and does not constitute a warranty. It may represent the result of Omron's test conditions, and the user must correlate it to actual application requirements. Actual performance is subject to the Omron's Warranty and Limitations of Liability.

### Change in Specifications.

Product specifications and accessories may be changed at any time based on improvements and other reasons. It is our practice to change part numbers when published ratings or features are changed, or when significant construction changes are made. However, some specifications of the Product may be changed without any notice. When in doubt, special part numbers may be assigned to fix or establish key specifications for your application. Please consult with your Omron's representative at any time to confirm actual specifications of purchased Product.

### Errors and Omissions.

Information presented by Omron Companies has been checked and is believed to be accurate; however, no responsibility is assumed for clerical, typographical or proofreading errors or omissions.

2015.4

In the interest of product improvement, specifications are subject to change without notice.

**OMRON Corporation**  
Industrial Automation Company

<http://www.ia.omron.com/>

(c)Copyright OMRON Corporation 2015 All Right Reserved.

## X-ON Electronics

Largest Supplier of Electrical and Electronic Components

*Click to view similar products for [Photoelectric Sensors](#) category:*

*Click to view products by [Omron](#) manufacturer:*

Other Similar products are found below :

[E3JM-DS70R4T-US](#) [E3L2DC4](#) [E3RA-DN12 2M](#) [E3RA-DP12 2M](#) [E3S5LE4S](#) [E3S-AD38](#) [E3S-CR11 5M](#) [E3SCT11D5M](#) [E3SCT11M1J03M](#)  
[E3T-SL14R](#) [E3T-SL24 5M](#) [E3T-ST12R](#) [E3X-CN02](#) [E3X-CN11 5M](#) [E3X-CN21 10M](#) [E3ZM-B66](#) [E3ZM-CL81H 2M](#) [E3Z-T62 2M](#)  
[NJL5303R-TE1](#) [PB10CNT15PO](#) [PD60CNX20BP](#) [CX-491-P-J](#) [CX-491-Z](#) [XUM2BKCNL2T](#) [XUM2BKCNL2T](#) [XUM2BNANL2R](#) [Y92E-](#)  
[ES30M](#) [Y92E-GS08SS](#) [ZXTDS04T](#) [ZX-XC4A 4M](#) [E3E23Y2US](#) [E3JM-DS70S4-US](#) [E3RA-RN11 2M](#) [E3S5LE42M](#) [E3S-LS20XB4 5M](#)  
[E3TFD14N](#) [E3T-FD14R](#) [E3T-SL21 5M](#) [E3T-SL21M](#) [E3T-ST11R](#) [E3T-ST12 5M](#) [E3X-DA41-S-M1J 0.3M](#) [E3X-DAB6](#) [E3X-DAG8](#) [E3ZM-](#)  
[B86](#) [E3ZM-CR81 2M](#) [E3ZM-CR86](#) [E3Z-T61A-L 2M](#) [ZX-XGC2R](#) [ZX-XB1A](#)