

## Standard MAG-MATE Terminals

### Product Facts

- Terminates all magnet wire film insulations
- Eliminates need for pre-stripping conductors
- Eliminates need to post insulate termination
- Excess magnet wire is automatically trimmed during the termination process
- Simultaneously terminates two magnet wires of the same size in one terminal (for splicing or bi-filing)
- Various lead wire attachment options available
- Available in strip form for semi-automatic or fully automatic insertions
- Available in loose piece form for hand tool insertions
- Varnish resist tab terminals are available for special applications
- High speed, fully automated integrated systems provide uniform terminations reliability at the lowest possible applied cost
- Clean metal-to-metal interface produces stable, gas-tight electrical terminations free of oxides and other contaminants
- Recognized under the Component Recognition Program of Underwriters Laboratories Inc., File No. E13288 

### Applications

- Motor windings and connections
- Coil connections
- Transformer windings and connections
- Bobbin connections
- Lighting ballasts
- Power supplies



Tyco Electronics offers a full selection of AMP Standard MAG-MATE Insulation Displacement Crimp (IDC) terminals for magnet wire terminations.

MAG-MATE terminals are available in poke-in, poke-in tab, splice, crimp wire barrel, solder post, quick connect tab, pin and receptacle styles.

Standard MAG-MATE terminates magnet wire ranging from 34-12 AWG [0.16 -2.05 mm].

Each IDC slot terminates up to four consecutive magnet wire ranges.



Two magnet wires with the same diameter can be terminated in one terminal down to 23 AWG [0.57 mm].

According to Tyco Electronics specifications MAG-MATE cavities are either integrated into coil bodies or especially designed cavity housings. The magnet wires are precisely positioned in the "U" shaped designed termination slots.

The MAG-MATE Inserter cuts the terminals from the strip and places the terminals over the magnet wire into the plastic cavities.

During this operation the small stripping devices penetrate the film insulation from the magnet wire.

Residual spring energy in the terminal causes the side walls of each IDC slot to function as opposing cantilever beams.

This constant pressure results in an intimate metal-to-metal interface, providing a reliable, long-term connection.

The wiping action between the wire and terminals removes oxides or other contaminants present on both the conductor and the terminal slot side walls, producing a clean, stable, gas-tight electrical termination.

The AMP MAG-MATE Inserter may be used as a semi-automatic bench machine or integrated in production lines for fully-automatic applications.

**Standard MAG-MATE Terminals** (Continued)

**Typical Plastic Cavities**

Manufacture only according to Tyco Electronics Specification.

**Technical Documents**

**Application Specifications** describe requirements for using the product in its intended application and or crimping information. They are intended for the Packaging and Design Engineer and the Machine Setup Person.

- 114-2050—Poke-In Tab MAG-MATE Terminals
- 114-2069—Standard MAG-MATE .187 [4.75] Box Height Terminals
- 114-2046—Standard MAG-MATE .300 [7.62] Box Height Terminals
- 114-2066—Standard MAG-MATE .500 [12.7] Box Height Terminals
- 114-2067—Standard MAG-MATE .300 [7.62] Box Height Latch-In Terminals Narrow Body
- 114-2094—Standard MAG-MATE .300 [7.62] Box Height Latch-In Terminals Wide Body

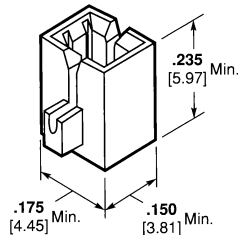

**Cavity Size 1,  
.187 [4.75] Box Height MAG-MATE  
(Reference Application  
Spec. 114-2069)**

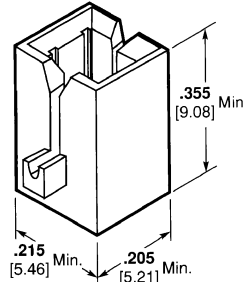

**Cavity Size 2,  
.300 [7.62] Box Height MAG-MATE  
(Reference Application  
Spec. 114-2046)**

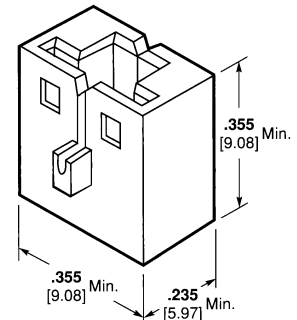

**Cavity Size 3,  
.300 [7.62] Box Height  
Latch-In MAG-MATE, Wide Body  
(Reference Application  
Spec. 114-2094)**

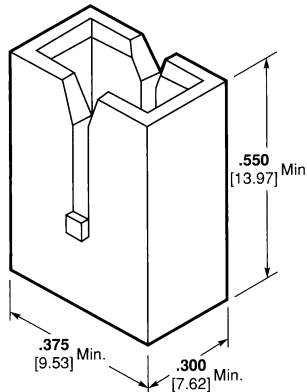

**Cavity Size 4,  
.500 [12.70] Box Height  
MAG-MATE  
(Reference Application  
Spec. 114-2066)**

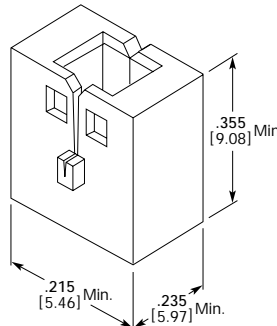

**Cavity Size 5,  
.300 [7.62] Box Height  
Latch-In MAG-MATE, Narrow  
Body  
(Reference Application  
Spec. 114-2067)**

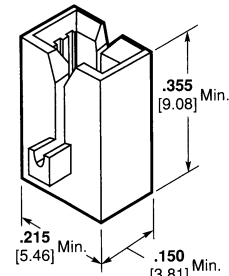

**Cavity Size 6,  
.300 [7.62] Box Height  
MAG-MATE  
(Reference Application  
Spec. 114-2046)**

**Note:** MAG-MATE typical plastic cavities are not for design; Tyco Electronics will supply required dimensions of cavity for each customer application.

Plastic cavities, designed to Tyco Electronics specifications, may be molded as part of the coil bobbin or attached to a lamination stack in the area of the magnet wire coil.

Each cavity is a rectangular box with two narrow slots on opposing walls and a plastic post or anvil extending upward from the bottom surface.

During or after the winding process, the magnet wire is placed across the plastic cavities and into the slots,

either manually or by coil winding equipment.

Unraveling is prevented by a slight friction fit, suitable bend or by wrapping the magnet wire around a tie-off post.

During insertion, two insulation displacing terminal slots strip the film insulation from the magnet wire producing a stable electrical termination.

The plastic anvil supports the magnet wire, helping to prevent it from being dragged down when the terminal is inserted.

Terminal retention is secured in the plastic cavities by either locking barbs or locking latches in addition to locking barbs for

quick disconnect FASTON tab terminals.

Excess magnet wire is trimmed flush with the outside of the plastic cavity by a shear blade traveling with the terminal insertion ram.

The sheared wire end can be tucked inside the plastic cavity, if necessary, by cutting the wire off before the terminal is fully seated allowing the terminal to drag the severed end of the wire into the pocket inside the cavity.

**Tyco Electronics will provide design and mold engineering resources to manufacture any specifically designed MAG-MATE cavity housing.**

## Standard MAG-MATE Terminals (Continued)

### Standard MAG-MATE Interconnection System

#### How the System Operates

- ① **Wire Cutter**  
This part cuts off the excess magnet wire and the wire support at the front of the cavity.
- ② **Insertion Finger**  
The insertion finger is part of the MAG-MATE Inserter. It pushes the terminal that was sheared from the carrier strip through the inserter "tube" into the positioned cavity.
- ③ **Contact**  
Various wire attachments in three different sizes, .187, .300, .500 cavity height (see tables).
- ④ **IDC Slot**  
In different sizes for magnet wire diameters from 34-12 AWG [0.16-2.05 mm]. Strain relief slots available for high vibration applications.
- ⑤ **Stripping Shoulders**  
During the insertion process, these shoulders strip the film insulation from the magnet wire in four areas.
- ⑥ **Locking Barbs**  
Terminal retention is secured in the cavity by four locking barbs.
- ⑦ **Plastic Cavity**  
Production must be in accordance with Tyco Electronics Application Specifications. **Consulting Tyco Electronics is required for design in.**
- ⑧ **Cavity Slot for Wire**  
The width has to be in accordance with the wire size (see Application Specification).
- ⑨ **Magnet Wire**  
The magnet wire is positioned in the "U" slot.
- ⑩ **Wire Support Block**  
The block supports the magnet wire during the cutting process. The magnet wire is cut flush to the cavity front side.
- ⑪ **Anvil**  
The anvil supports the wire during the insertion process.



#### Termination Sequence

- A = Prepare
- B = Insert
- C = Finish

- ① Post Trim Blade
- ② Insertion Finger
- ③ Poke-In Contact
- ④ MAG-MATE Cavity
- ⑤ Magnet Wire
- ⑥ Support Anvil



**Standard MAG-MATE Terminals** (Continued)

**Test Results**

**Standard and Slim Line MAG-MATE** products have been submitted to the following tests without significant millivolt increase:

**Current Cycling** — 480 cycles with each cycle consisting of 15 minutes "ON" followed by 15 minutes "OFF"  
**Thermal Shock** — 25 cycles with each cycle consisting of 30 minutes at 125°C followed by 30 minutes at -65°C

**Humidity** —  
**Temperature Cycling** 10 cycles between 25°C and 65°C at 95% RH  
**Heat Age** — 33 days at 118°C

**Mini MAG-MATE** products have been submitted to the following tests in addition to those listed without significant millivolt increase:

**Vibration** — 10-55-01- Hz traversed in 1 minute at .06 inches total excursion; 2 hours in each of 3 mutually perpendicular directions.  
**Industrial Gas with Chlorine** — 1000 exposure to 200 ppb each of sulphur dioxide, nitrogen dioxide, hydrogen sulphide and 50 ppb chlorine.

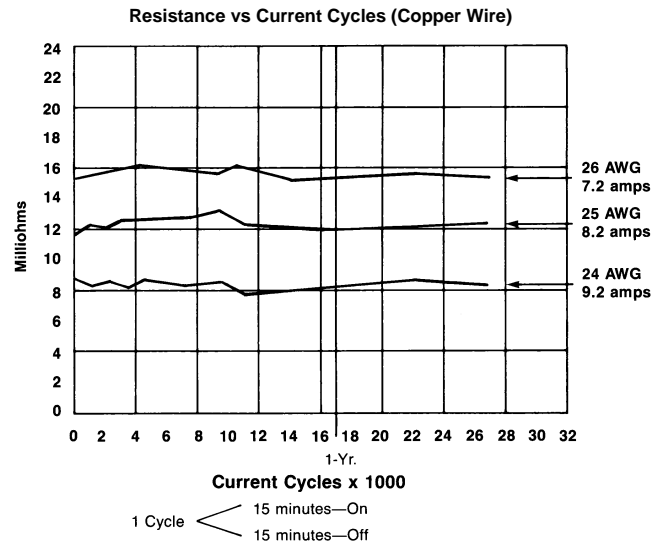
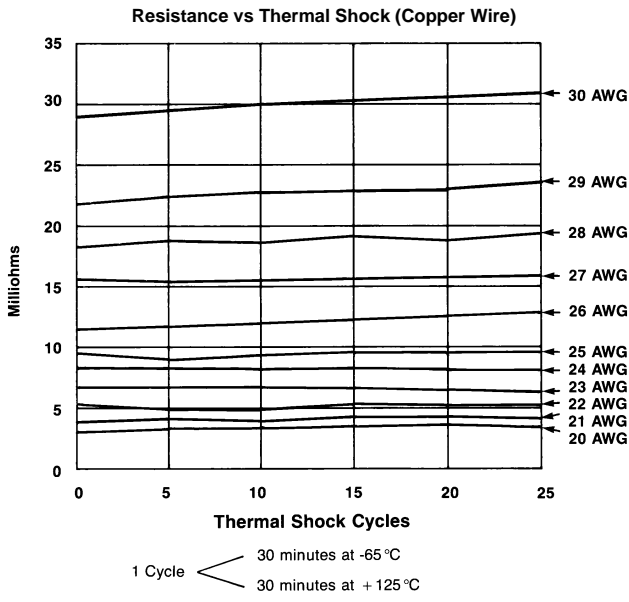
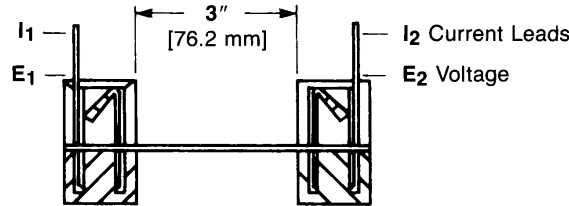

Test Current produces 100°C Magnet Wire Operating Temperature

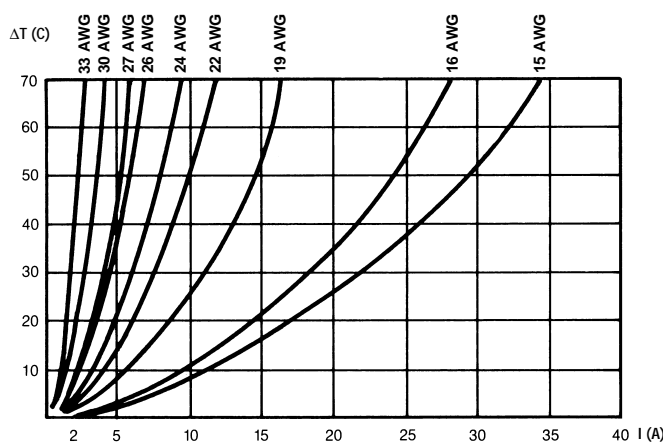

**Current Rating Curves**  
 The diagram shows the temperature rise of the contact, depending on the magnet wire size being applied.

**Product Specifications** describe technical performance characteristics and verification tests. They are intended for the Design, Test and Quality Engineer.

- 108-2012 Standard .187and .300 MAG-MATE Terminals
- 108-2053 Standard .500 Box MAG-MATE Terminals
- 108-1484 Slim Line MAG-MATE Terminals
- 108-2016 Mini MAG-MATE Terminals

**Note:** For all applications, Tyco Electronics recommends that samples of the magnet wire to be used be submitted for engineering evaluation.

Dimensions are in inches and millimeters unless otherwise specified. Values in brackets are metric equivalents.

Dimensions are shown for reference purposes only. Specifications subject to change.

Technical Support  
 USA: 1-800-522-6752  
 Canada: 1-905-475-6222  
 Mexico: 01-800-733-8926

## Standard MAG-MATE Terminals (Continued)

### 300 Box Poke-In Terminals

**Material**

Tin plated brass

**Typical Cavity Size 2**

(See page 2)

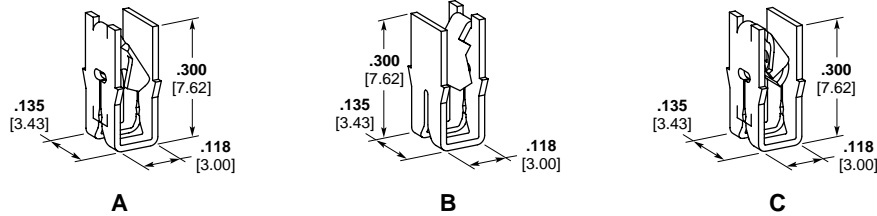

Type	Copper Magnet Wire Range <sup>1</sup>		Lead Wire Range <sup>3</sup>		Stock Thickness	Part Number*		
	AWG	mm	AWG	mm <sup>2</sup>		Strip	L. P.	Dual L. P.
A 300 Box Standard IDC Locking Poke-In	34-33	0.16-0.18	20-18	0.5-0.9	<b>.010</b> 0.25	63662-1	—	—
	33-31	0.18-0.23	20-18	0.5-0.9	<b>.010</b> 0.25	<b>62431-1</b>	62527-1	—
	31-28	0.23-0.32	20-18	0.5-0.9	<b>.012</b> 0.30	1217234-1	—	—
	30-27	0.25-0.36	20-18	0.5-0.9	<b>.012</b> 0.30	<b>62429-1</b> 63636-1 <sup>8</sup>	62526-1	63855-1
	27-23	0.36-0.57	20-18	0.5-0.9	<b>.016</b> 0.41	62935-1 63754-1 <sup>5</sup>	63044-1	62842-1
	25-22 <sup>2</sup>	0.45-0.64	20-18	0.5-0.9	<b>.016</b> 0.41	63658-1 1217084-1 <sup>5</sup>	1217757-1	—
	22-20 <sup>2</sup>	0.64-0.81	20-18	0.5-0.9	<b>.016</b> 0.41	<b>62420-1</b> 62420-4 <sup>6</sup> 1217824-1 <sup>1</sup>	62524-1	62841-1
			—	—		63725-1 <sup>5</sup>	—	—
	20 <sup>2</sup>	0.81	20-18	0.5-0.9	<b>.016</b> 0.41	63591-1	—	—
	19-17 <sup>2</sup>	0.91-1.15	20-18	0.5-0.9	<b>.016</b> 0.41	<b>62833-1</b>	62912-1	1217736-1 <sup>†</sup>
B <sup>4</sup> 300 Box Standard IDC w/ Strain Relief Slot Locking Poke-In	30	0.25	20-18	0.5-0.9	<b>.012</b> 0.30	63786-1 <sup>†</sup>	—	—
	29-28 <sup>2</sup>	0.29-0.32	20-18	0.5-0.9	<b>.012</b> 0.30	1217011-1	—	—
	28-26 <sup>2</sup>	0.32-0.40	20-18	0.5-0.9	<b>.012</b> 0.30	1217368-1	—	—
	27-23 <sup>2</sup>	0.36-0.57	20-18	0.5-0.9	<b>.016</b> 0.41	63789-1	—	—
C 300 Box Standard IDC Non-Locking Poke-In	31-28	0.23-0.32	—	—	<b>.012</b> 0.30	1217026-1	—	—
	30-27	0.25-0.36	—	—	<b>.012</b> 0.30	63590-1 <sup>7</sup> 63590-2 63590-3 <sup>6</sup>	—	—
	27-23	0.36-0.57	—	—	<b>.016</b> 0.41	63551-1 <sup>7</sup> 63551-2 <sup>†</sup> 63551-3 <sup>6</sup>	—	—
	27-26	0.36-0.40	—	—	<b>.016</b> 0.41	1217192-1	—	—
	25.5-24	0.43-0.51	—	—	<b>.016</b> 0.41	1217191-1	—	—
	23.5-22 <sup>2</sup>	0.54-0.64	—	—	<b>.016</b> 0.41	1217190-1	—	—
21.5-20 <sup>2</sup>	0.68-0.81	—	—	<b>.016</b> 0.41	1217189-1	—	—	

<sup>1</sup> Two magnet wires may be terminated in the same terminal slot if diameters are equal.

<sup>2</sup> Single magnet wire only; 22 AWG [0.64 mm] or larger unless otherwise noted.

<sup>3</sup> Solid or overcoated stranded lead wire only. Product will also accept Poke-In Tab Terminal shown on page 7.

<sup>4</sup> Strain relief slot for high vibration applications.

<sup>5</sup> Enhanced anti-overstress behind Poke-In feature for severe applications. Part does not accept lead wires.

<sup>6</sup> Finish is tin plated phosphor bronze.

<sup>7</sup> Finish is tin over nickel plated brass.

<sup>8</sup> Deep Poke-In design for enhanced lead wire retention. Special cavity design required. Contact Tyco Electronics Engineering for details.

\* Recognized under the Component Program of Underwriters Laboratories, Inc.

† These part numbers are available upon special request; contact Tyco Electronics Engineering for details.

**Preferred part numbers are printed in bold.**

Chart continued on next page

Dimensions are in inches and millimeters unless otherwise specified. Values in brackets are metric equivalents.

Dimensions are shown for reference purposes only. Specifications subject to change.

Technical Support  
USA: 1-800-522-6752  
Canada: 1-905-475-6222  
Mexico: 01-800-733-8926

www.tycoelectronics.com

**Standard MAG-MATE Terminals** (Continued)

**300 Box Poke-In Terminals**

(Continued)

**Material**

Tin plated brass

**Typical Cavity Size 2**

(See page 2)

**Note:** Special cavity required for Tri-slot splice terminal. Contact Tyco Electronics Engineering for details.



Type	Copper Magnet Wire Range <sup>1</sup>		Stock Thickness	Strip Part Number
	AWG	mm		
D4 300 Box Standard IDC w/ Strain Relief Slot Non-Locking Poke-In	27-26	0.36-0.40	.016 0.41	1217429-1 1217691-1 <sup>3</sup>
	25.5-24	0.43-0.51	.016 0.41	1217428-1 1217690-1 <sup>3</sup>
	23.5-22 <sup>2</sup>	0.54-0.64	.016 0.41	1217427-1 1217689-1 <sup>3</sup>
	21.5-20 <sup>2</sup>	0.68-0.81	.016 0.41	1217426-1 1217688-1 <sup>3</sup>
E 300 Box Standard IDC Tri-Slot Non-Locking Poke-In	30-27 <sup>2</sup>	0.25-0.36	.016 0.41	1217221-1 <sup>†</sup>
	27-23 <sup>2</sup>	0.36-0.57	.016 0.41	63632-1
	23-20 <sup>2</sup>	0.57-0.81	.016 0.41	1217533-1 <sup>†</sup>
	27-23 <sup>2</sup> 19-17 <sup>2</sup> 18 <sup>2</sup>	0.36-0.57 0.91-1.15 0.8-0.9	.016 0.41	63975-1

<sup>1</sup> Two magnet wires may be terminated in the same terminal slot if diameters are equal.  
<sup>2</sup> Single magnet wire only; 22 AWG [0.64 mm] or larger.  
<sup>3</sup> Enhanced anti-overstress behind Poke-In feature for severe applications. Part does not accept lead wires.  
<sup>4</sup> Strain relief slot for high vibration applications.  
<sup>†</sup> These part numbers are available upon special request; contact Tyco Electronics Engineering for details.  
 \* Recognized under the Component Program of Underwriters Laboratories, Inc.

**500 Box Poke-In Terminals**

**Material**

Tin plated brass

**Typical Cavity Size 4**

(See page 2)

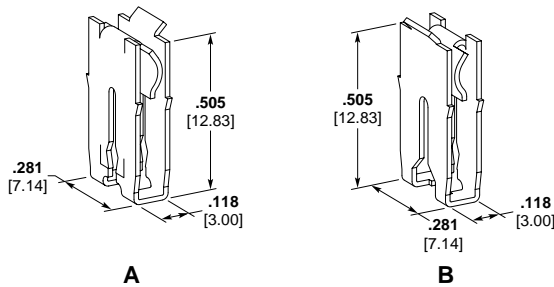

Type	Copper Magnet Wire Range <sup>1</sup>		Stock Thickness	Strip Part Number
	AWG	mm		
A 500 Box Standard IDC Non-Locking Poke-In	23-19.5	0.57-0.86	.016 0.41	1217069-1
	19-17	0.91-1.15	.016 0.41	1217068-1
	16-15	1.29-1.45	.016 0.41	1217067-1
B <sup>3</sup> 500 Box Standard IDC w/ Strain Relief Slot Non-Locking Poke-In	23-21.5	0.57-0.68	.016 0.41	1217358-1
	21-19.5	0.72-0.86	.016 0.41	1217357-1
	19-17	0.91-1.15	.016 0.41	1217356-1
	16-15 14-13 <sup>2</sup>	1.29-1.45 1.61-1.83	.016 0.41	1217355-1 1217579-1 <sup>†</sup>

<sup>1</sup> Two magnet wires may be terminated in the same terminal slot if diameters are equal.  
<sup>2</sup> Single magnet wire only.  
<sup>3</sup> Strain relief slot for high vibration applications.  
<sup>†</sup> These part numbers are available upon special request; contact Tyco Electronics Engineering for details.

## Standard MAG-MATE Terminals (Continued)

### Poke-In Tab Terminals

#### Materials

Tin plated brass



Type	Lead Wire Size <sup>1</sup>		Ins. O.D.	Stock Thickness	Strip Part Number
	AWG	mm <sup>2</sup>			
A 90° Up	22-18	0.3-0.9	—	.018 0.46	62895-1*
				.020 0.51	63410-1
B 90° Up w/Ins. Sup.	22-18	0.3-0.9	.060-.100 1.52-2.54	.018 0.46	62896-1*
				.020 0.51	1217132-1 <sup>2</sup>
C Straight	22-18	0.3-0.9	—	.020 0.51	63218-1
				.020 0.51	62897-1*
D Straight w/Ins. Sup.	22-18	0.3-0.9	.060-.100 1.52-2.54	.018 0.46	62898-1*
				.020 0.51	63574-1 <sup>3</sup>
E 90° Down	22-18	0.3-0.9	—	.020 0.51	63631-14,†
				.018 0.46	1217470-1 <sup>5</sup>
F 90° Down w/Ins. Sup.	18-14	0.8-2.0	.090-.140 2.29-3.56	.020 0.51	63397-1†
				.018 0.46	63458-1
G Flag - 300 Box only	20-16	0.5-1.4	—	.020 0.51	1217214-1 <sup>6</sup>
				.020 0.51	1217406-17
H Flag - 500 Box only	18-14	0.8-2.0	.080-.120 2.03-3.05	.032 0.81	1217875-1†
				.032 0.81	1217324-1

<sup>1</sup> Stranded, fused stranded or solid lead wire.

<sup>2</sup> Shallow tab serrations.

<sup>3</sup> Tab serration on top of tab only.

<sup>4</sup> No serrations on tab.

<sup>5</sup> Includes diode slot for 20 AWG [0.8 mm] diameter solid copper diode wire.

<sup>6</sup> Special serration location for deeper poke-in.

<sup>7</sup> Deeper poke-in. Special cavity detail required.

† These part numbers are available upon special request; contact Tyco Electronics Engineering for details.

\* Recognized under the Component Program of Underwriters Laboratories, Inc.

**Note:** All tab terminals accept stranded, fused stranded or solid lead wire.

## Standard MAG-MATE Terminals (Continued)

### 300 Box Splice Terminals

#### Material

Tin plated brass

**.300 [7.62] Series Box**  
Typical Cavity Size 2, when  
"C" dimension is .120 [3.05]  
(See page 2)

Typical Cavity Size 6, when  
"C" dimension is .070 [1.78]  
(See page 2)

**Note:** Special cavity required for  
Tri-slot splice terminal.  
Contact Tyco Electronics  
Engineering for details.



Type	Copper Magnet Wire Range <sup>1</sup>		Dim. C	Stock Thickness	Part Number	
	AWG	mm			Strip	L. P.
A 300 Box Standard IDC Splice	33-31	0.18-0.23	.070 1.78	.012 0.30	—	63531-1
	31-28	0.23-0.32	.070 1.78	.012 0.30	—	63532-1
	27-24	0.36-0.50	.070 1.78	.012 0.30	—	63533-1†
	20-18 <sup>3</sup>	0.81-1.02	.120 3.05	.020 0.51	62903-1	—
B 300 Box Standard IDC Tri-Slot Splice	28-24	0.32-0.51	—	.016 0.41	1217858-1†	—
	23-20 <sup>2</sup>	0.57-0.81	—	.016 0.41	1217853-1†	—
	27-23	0.36-0.57	—	.016 0.41	1217613-1†	—
	18 <sup>4</sup>	0.8-0.9	—	.016 0.41	1217613-1†	—
	19-17 <sup>2</sup>	0.91-1.15	—	.016 0.41	1217613-1†	—
	25-22 <sup>3</sup>	0.45-0.64	—	.016 0.41	1217209-1	—
	18 <sup>4</sup>	0.8-0.9	—	.016 0.41	1217209-1	—
	23.5-20 <sup>2</sup>	0.54-0.81	—	.016 0.41	1217209-1	—

<sup>1</sup> Two magnet wires may be terminated in the same terminal slot if diameters are equal.

<sup>2</sup> Single magnet wire only; 22 AWG [0.64 mm] or larger.

<sup>3</sup> Bare wire only.

<sup>4</sup> Single solid or fused stranded lead wire only.

† These part numbers are available upon special request; contact Tyco Electronics Engineering for details.

### Dual Connection Terminals

#### Material

Tin plated brass

**Note:** Special cavity required.  
Contact Tyco Electronics  
Engineering for details.

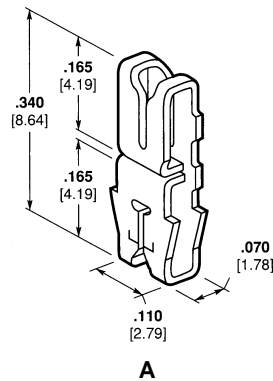

Type	Copper Magnet Wire Range <sup>1</sup>		Solid Lead Wire Range		Stock Thickness	Strip Part Number
	AWG	mm	AWG	mm		
A 165 Box Standard IDC Splice	32-31	0.20-0.23	26-24	0.40-0.51	.012 0.30	63005-1†
	30-28	0.25-0.32	26-24	0.40-0.51	.012 0.30	63087-1†
	30-27	0.25-0.36	26-24	0.40-0.51	.012 0.30	62766-1†

<sup>1</sup> Two magnet wires may be terminated in the same terminal lower slot if diameters are equal.

† These part numbers are available upon special request; contact Tyco Electronics Engineering for details.



**Standard MAG-MATE Terminals** (Continued)

**Dual Connection Terminals**

(Continued)

**Material**

Tin plated phos. bronze

**Note:** Special cavity required.  
Contact Tyco Electronics  
Engineering for details.



**B**

Type	Copper Magnet Wire Range <sup>1</sup>		Mating Tab	Stock Thickness	Strip Part Number
	AWG	mm			
B 185 Box Standard IDC Tab Receptacle	32-31	0.20-0.23	.070 x .020 1.78 x 0.51	.010 0.25	1217538-1
	30-28	0.25-0.32	.070 x .020 1.78 x 0.51	.010 0.25	1217457-1
	29-28	0.29-0.32	.070 x .020 1.78 x 0.51	.010 0.25	1217458-1

<sup>1</sup> Two magnet wires may be terminated in the same slot if diameters are equal.

**300 Box F-Crimp Terminals**

**Material**

Tin plated brass

**.300 [7.62] Series Box**

Typical Cavity Size 2, when  
"C" dimension is .120 [3.05]  
(See page 2)

Typical Cavity Size 6, when "C"  
dimension is .070 [1.78]  
(See page 2)

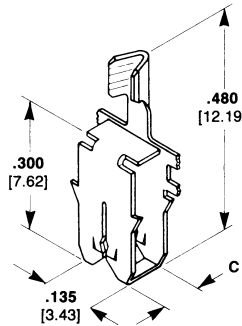

**A**

Type	Copper Magnet Wire Range <sup>1</sup>		Dim. C	Lead Wire Range <sup>3</sup>		Stock Thickness	Part Number	
	AWG	mm		AWG	mm <sup>2</sup>		Strip	L. P.
A 300 Box Standard IDC F-Crimp	33-31	0.18-0.23	.070 1.78	22-18	0.3-1.0	.012 0.30	63235-1	—
			.120 3.05	24-20	0.2-0.6	.012 0.30	63420-1†	—
	31-28	0.23-0.32	.070 1.78	22-18	0.3-1.0	.012 0.30	63236-1	—
	30-27	0.25-0.36	.120 3.05	24-20	0.2-0.6	.012 0.30	62992-1	—
	28-24	0.32-0.51	.120 3.05	24-20	0.2-0.6	.012 0.30	63641-1	—
	27-24	0.36-0.51	.070 1.78	22-18	0.3-1.0	.012 0.30	63237-1	—
	27-23	0.36-0.57	.120 3.05	24-20	0.2-0.6	.016 0.41	62459-1	62666-1†
	25-22	0.45-0.64	.070 1.78	22-18	0.3-1.0	.012 0.30	63690-1†	—
	22-20 <sup>2</sup>	0.64-0.81	.120 3.05	24-20	0.2-0.6	.016 0.41	62458-1	62665-1†

<sup>1</sup> Two magnet wires may be terminated in the same terminal slot if diameters are equal.

<sup>2</sup> Single magnet wire only; 22 AWG [0.64 mm] or larger.

<sup>3</sup> Stranded, fused stranded or solid lead wire.

† These part numbers are available upon special request; contact Tyco Electronics Engineering for details.

**Standard MAG-MATE Terminals** (Continued)

**187 Box F-Crimp Terminals**

**Material**

Tin plated brass  
.187 [4.75] Series Box  
Typical Cavity Size 1  
(See page 2)



Type	Copper Magnet Wire Range <sup>1</sup>		Lead Wire Range <sup>3</sup>		Ins. O.D.	Stock Thickness	Strip Part Number
	AWG	mm	AWG	mm <sup>2</sup>			
A 187 Box Standard IDC F-Crimp	33-31	0.18-0.23	26-22	0.12-0.3	—	.010 0.25	63039-1 63039-2 <sup>3,5</sup>
	30-28	0.25-0.32	26-22	0.12-0.3	—	.012 0.30	63036-1 62608-14 62608-34
	27-25	0.36-0.46	26-22	0.12-0.3	—	.012 0.30	62609-14 62609-34
	26-24	0.40-0.51	22-18	0.3-1.0	—	.012 0.30	1217146-1
	24-22 <sup>2</sup>	0.51-0.64	26-22	0.12-0.3	—	.012 0.30	62610-14
B 187 Box F-Crimp w/ Ins Sup.	27-25	0.36-0.46	22-18	0.3-1.0	.071-.088 1.80-2.23	.012 0.30	63856-1 63856-2

- <sup>1</sup> Two magnet wires may be terminated in the same terminal slot if diameters are equal.
- <sup>2</sup> Single magnet wire only.
- <sup>3</sup> Stranded, fused stranded or solid lead wire.
- <sup>4</sup> Strip rereeled to feed through mini-applicator to crimp lead wire first, magnet wire termination is secondary operation.

**300 Box Posted PCB Terminals**  
**Solder Terminal**

**Material**

Tin over copper plated brass

**Typical Cavity Size**

(See page 2)  
Type A—Cavity Size 2  
Type B—Cavity Size 6



Type	Copper Magnet Wire Range <sup>1</sup>		Dim. L	Stock Thickness		Strip Part Number
	AWG	mm		Tab Section	Mag Wire	
A 300 Box Standard IDC PCB Post	33-31	0.18-0.23	.540 13.72	.010 0.25	.010 0.25	63253-1
	31-28	0.23-0.32	.540 13.72	.010 0.25	.010 0.25	62928-1*
	29-26	0.29-0.40	.540 13.72	.012 0.30	.012 0.30	62958-1*
	27-23	0.36-0.57	.460 11.68	.016 0.41	.016 0.41	63659-1
	22-20 <sup>2</sup>	0.64-0.81	.460 11.68	.016 0.41	.016 0.41	63660-1
	19-17 <sup>2</sup>	0.91-1.15	.460 11.68	.016 0.41	.016 0.41	63661-1
B PCB Post Shallow Box	33-31	0.18-0.23	.475 12.07	.020 0.51	.012 0.30	1217302-1

- <sup>1</sup> Two magnet wires may be terminated in the same terminal slot if diameters are equal.
- <sup>2</sup> Single magnet wire only.
- \* Recognized under the Component Program of Underwriters Laboratories, Inc.
- Note:** PC Board hole size .050 [1.27].

**Standard MAG-MATE Terminals** (Continued)

**187 Box Posted PCB Terminals**

**Material**

Tin plated brass, except where noted

**Typical Cavity Size 1**

(See page 2)



Type	Copper Magnet Wire Range <sup>1</sup>		Dim. L	Stock Thickness	Part Number	
	AWG	mm			Strip	L.P.
A 187 Box Standard IDC PCB Post	33-31	0.18-0.23	.267 6.78	.010 0.25	63565-1	—
			.330 8.38	.010 0.25	62938-1 62938-2 <sup>3</sup>	62934-1 —
	30-28	0.25-0.32	.267 6.78	.012 0.30	63160-1	—
			.287 7.29	.012 0.30	63818-1	—
	27-25	0.36-0.46	.330 8.38	.012 0.30	62430-1 62430-2 <sup>3</sup>	62874-1 —
			.330 8.38	.012 0.30	62438-1 62438-2	—
24-22 <sup>2</sup>	0.51-0.64	.287 7.29	.012 0.30	63819-1	—	
		.330 8.38	.012 0.30	62439-1 62439-2 <sup>4</sup> 62439-3 <sup>3</sup>	63645-1† — —	

- 1 Two magnet wires may be terminated in the same terminal slot if diameters are equal.
- 2 Single magnet wire only.
- 3 Reverse reeled version of -1.
- 4 Finish is tin over nickel plated brass.
- † These part numbers are available upon special request; contact Tyco Electronics Engineering for details.

**187 Box Tab Terminals**

**Material**

Tin plated brass, except when noted

**Typical Cavity Size 1**

(See page 2)

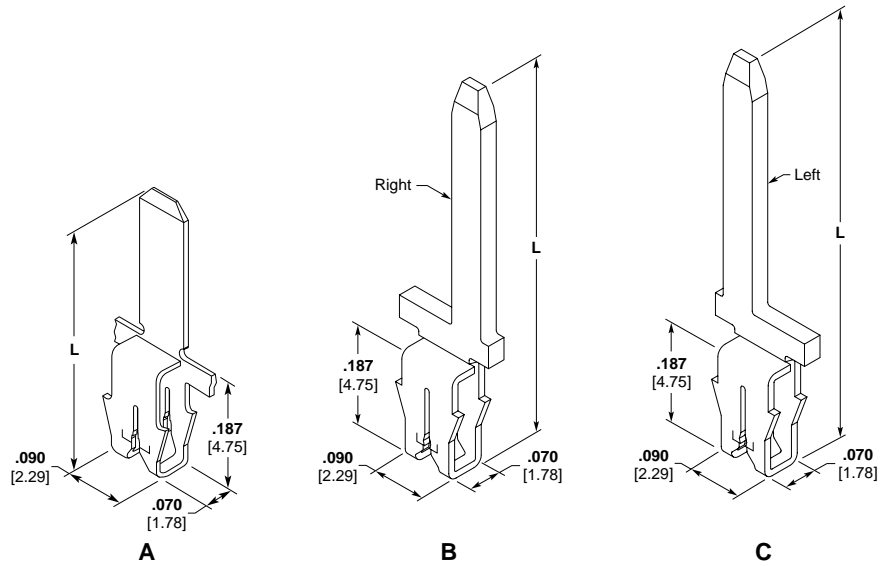

Type	Copper Magnet Wire Range <sup>1</sup>		Dim. L	Tab Size	Stock Thickness		Strip Part Number
	AWG	mm			Tab Section	Mag Wire	
A 187 Box Standard IDC Straight Tab	30-28	0.25-0.32	.432 10.97	.110 x .020 2.79 x 0.51	.020 0.51	.012 0.30	63702-1
			.432 10.97	.110 x .020 2.79 x 0.51	.020 0.51	.012 0.30	1217196-1 <sup>3</sup>
	30	0.25	.550 14.00	.071 x .025 1.80 x 0.63	.025 0.63	.012 0.30	1217405-1
	25-22 <sup>2</sup>	0.46-0.64	.700 17.78	.059 x .032 1.50 x 0.81	.032 0.81	.012 0.30	1217013-1
B 187 Box Standard IDC Offset Tab-R.H.	27-25	0.36-0.45	.565 14.36	.059 x .032 1.50 x 0.81	.032 0.81	.012 0.30	1217641-1
			.700 17.78	.059 x .032 1.50 x 0.81	.032 0.81	.012 0.30	1217459-1
C 187 Box Standard IDC Offset Tab-L.H.	27-25	0.36-0.45	.565 14.36	.059 x .032 1.50 x 0.81	.032 0.81	.012 0.30	1217642-1
			.700 17.78	.059 x .032 1.50 x 0.81	.032 0.81	.012 0.30	1217460-1

- 1 Two magnet wires may be terminated in the same terminal if diameters are equal.
- 2 Single magnet wire only.
- 3 Finish is tin over nickel plated brass.

## Standard MAG-MATE Terminals (Continued)

### 300 Box Tab Terminals

**Material**

Tin plated brass

**Typical Cavity Size 2**

(See page 2)



Type	Copper Magnet Wire Range <sup>1</sup>		Dim. L	Tab Size	Stock Thickness		Part Number	
	AWG	mm			Tab Section	Mag Wire	Strip	L.P.
A 300 Box Standard IDC Straight Tab	20	0.79	.750 19.05	.063 x .025 1.60 x 0.63	.025 0.63	.016 0.41	63965-12	—
			.895 22.73	.063 x .025 1.60 x 0.63	.025 0.63	.016 0.41	1217595-12	—
	31	0.23	.870 22.10	.062 x .032 1.57 x 0.81	.032 0.81	.010 0.25	63810-1	—
B 300 Box Standard IDC Offset Tab-R.H.	33-31	0.18-0.23	.660 16.76	.071 x .025 1.80 x 0.63	.025 0.63	.010 0.25	63909-1	—
			.669 17.75	.091 x .025 2.31 x 0.63	.025 0.63	.010 0.25	63927-1	—
	30	0.25	.669 17.75	.091 x .025 2.31 x 0.63	.025 0.63	.010 0.25	1217052-1	—
C 300 Box Standard IDC Offset Tab-L.H.	33-31	0.18-0.23	.660 16.76	.071 x .025 1.80 x 0.63	.025 0.63	.010 0.25	63910-1	—
			.669 17.75	.091 x .025 2.31 x 0.63	.025 0.63	.010 0.25	63910-2 <sup>3</sup>	—
	30	0.25	.669 17.75	.091 x .025 2.31 x 0.63	.025 0.63	.010 0.25	1217051-1	—
D 300 Box Standard IDC Universal Offset Tab	31-28	0.23-0.32	1.230 31.25	.071 x .025 1.80 x 0.63	.025 0.63	.012 0.30	63773-1	—
	32	0.20	1.098 27.90	.118 x .025 3.00 x 0.63	.025 0.63	.010 0.25	63247-1 63247-2 <sup>3</sup>	1217032-1 —

<sup>1</sup> Two magnet wires may be terminated in the same terminal slot if diameters are equal.

<sup>2</sup> Tinsel wire only.

<sup>3</sup> Reverse reeled version of -1.



Typical Cavity Size 2, when "C" dimension is .120 [3.05] (See page 2)

Typical Cavity Size 6, when "C" dimension is .070 [1.78] (See page 2)

Type	Copper Magnet Wire Range <sup>1</sup>		Dim. C	Tab Size	Stock Thickness		Strip Part Number
	AWG	mm			Tab Section	Mag Wire	
E 300 Box Standard IDC Twisted Tab	33-31	0.18-0.23	.070 1.78	.125 x .020 3.17 x 0.51	.020 0.51	.012 0.30	63806-1
	31-28	0.23-0.32	.070 1.78	.125 x .020 3.17 x 0.51	.020 0.51	.012 0.30	63807-1
	27-24	0.36-0.50	.070 1.78	.125 x .020 3.17 x 0.51	.020 0.51	.012 0.30	63808-1
	21 <sup>2</sup>	0.72	.120 3.05	.118 x .030 3.00 x 0.76	.030 0.76	.016 0.41	63463-1
	19.5 <sup>2</sup>	0.86	.120 3.05	.118 x .030 3.00 x 0.76	.030 0.76	.016 0.41	63216-1

<sup>1</sup> Two magnet wires may be terminated in the same terminal slot if diameters are equal.

<sup>2</sup> Single magnet wire only.

**Standard MAG-MATE Terminals** (Continued)

**300 Box Tab Terminals**

(Continued)

**Material**

Tin plated brass

**Typical Cavity Size 2**

(See page 2)

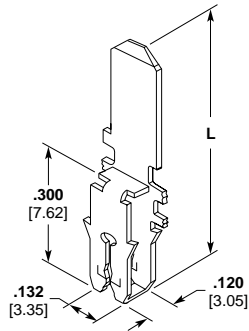

**F**

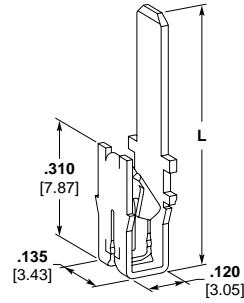

**G**

Type	Copper Magnet Wire Range		Dim. L	Tab Size	Stock Thickness		Strip Part Number
	AWG	mm			Tab Section	Mag Wire	
F 300 Box Standard IDC Timer Tab	33-31	0.18-0.23	.585 14.86	.118 x .020 3.00 x 0.51	.020 0.51	.010 0.25	1217746-1†
	30-28	0.25-0.32	.585 14.86	.118 x .020 3.00 x 0.51	.020 0.51	.010 0.25	1217745-1†
	27-23	0.36-0.57	.585 14.86	.118 x .020 3.00 x 0.51	.020 0.51	.016 0.41	63973-1
			.585 14.86	.125 x .020 3.00 x 0.51	.020 0.51	.016 0.41	63489-1
	25-22 <sup>2</sup>	0.45-0.64	.585 14.86	.118 x .020 3.00 x 0.51	.020 0.51	.016 0.41	1217596-1†
	23.5-21.5 <sup>2</sup>	0.54-0.68	.585 14.86	.118 x .020 3.00 x 0.51	.020 0.51	.016 0.41	1217593-1†
	23-20 <sup>2</sup>	0.57-0.81	.775 19.68	.125 x .020 3.00 x 0.51	.020 0.51	.016 0.41	63899-1
	19-17 <sup>2</sup>	0.91-1.15	.585 14.86	.118 x .020 3.00 x 0.51	.020 0.51	.016 0.41	63972-1
	18 Lead <sup>2</sup>	1.02	.585 14.86	.118 x .020 3.00 x 0.51	.020 0.51	.016 0.41	63974-1 63974-2 <sup>3</sup>
			.665 16.89	.118 x .020 3.00 x 0.51	.020 0.51	.016 0.41	1217210-1 1217210-2 <sup>3</sup>
G <sup>4</sup> 300 Box Standard IDC Poke-In Combination Tab	25-22 <sup>2</sup>	0.45-0.64	.665 16.89	.118 x .020 3.00 x 0.51	.020 0.51	.016 0.41	1217210-1 1217210-2 <sup>3</sup>
	23.5-20 <sup>2</sup>	0.54 0.81	.665 16.89	.118 x .020 3.00 x 0.51	.020 0.51	.016 0.41	1217211-1

<sup>1</sup> Two magnet wires may be terminated in the same terminal slot if diameters are equal.

<sup>2</sup> Single magnet wire only; 22 AWG [0.64 mm] or larger.

<sup>3</sup> Reverse reeled version of -1.

<sup>4</sup> Poke-In feature accepts 20-18 AWG [0.5-0.8 mm<sup>2</sup>] Solid or overcoated stranded lead wire or 90° Poke-In tab.

† These part numbers are available upon special request; contact Tyco Electronics Engineering for details.

### Standard MAG-MATE Terminals (Continued)

#### Pin Receptacle Terminals with Right or Left Hand Diode Lead Slot

##### Material

Tin plated brass

##### Typical Cavity Size 2

(See page 2)

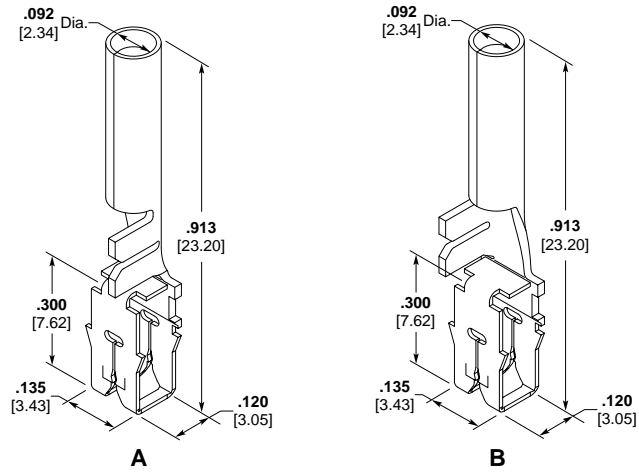

Type	Copper Magnet Wire Range <sup>1</sup>		Diode Lead		Mating Pin Dia.	Stock Thickness		Strip Part Number
	AWG	mm	AWG	mm		I/O	Mag Wire	
A 300 Box Diode Offset- R.H.	32-31	0.20-0.23	22	0.64	.094 2.39	.014 0.36	.010 0.25	63208-1† 63326-1
B 300 Box Diode Offset- L.H.	31-27	0.23-0.36	22	0.64	.094 2.39	.014 0.36	.010 0.25	63209-1† 63308-1

<sup>1</sup> Two magnet wires may be terminated in the same terminal slot if diameters are equal.

† These part numbers are available upon special request; contact Tyco Electronics Engineering for details.

#### Pin I/O Terminals

##### Material

Tin plated brass

##### .300 [7.62] Series Box

Styles A, B and C  
Typical Cavity Size 2  
(See page 2)

##### .500 [12.7] Series Box

Style D  
Typical Cavity Size 4  
(See page 2)

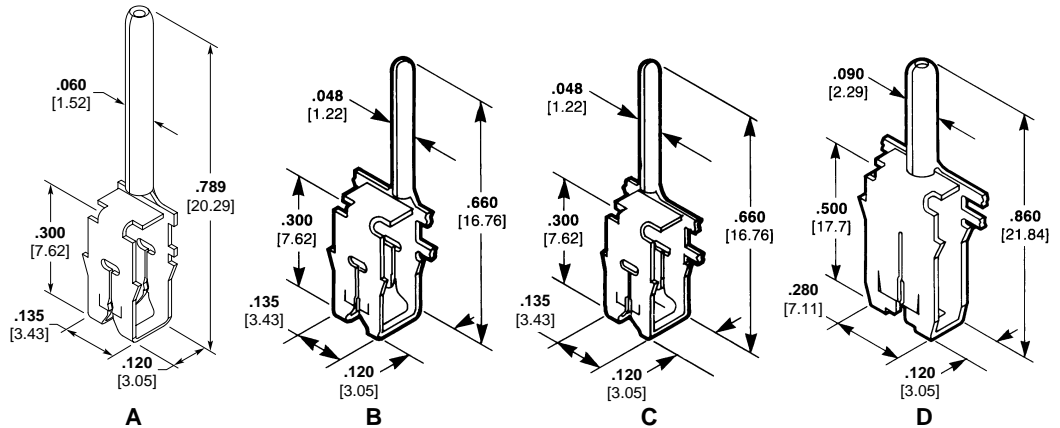

Type	Copper Magnet Wire Range <sup>1</sup>		Pin Dia.	Stock Thickness		Part Number	
	AWG	mm		I/O	Mag Wire	Strip	L.P.
A 300 Box Straight Pin	27-23	0.36-0.57	.060 1.52	.010 0.25	.010 0.25	63722-1	—
B 300 Box Offset Pin-R.H.	33-31	0.18-0.23	.048 1.22	.010 0.25	.010 0.25	63443-1	—
	33-31	0.18-0.23	.048 1.22	.010 0.25	.010 0.25	63444-1	—
C 300 Box Offset Pin-L.H.	31-28	0.23-0.32	.048 1.22	.010 0.25	.010 0.25	63569-1	63879-1
	27-23	0.36-0.57	.048 1.22	.010 0.25	.016 0.25	63570-1	63880-1
	25-222	0.45-0.64	.048 1.22	.010 0.25	.016 0.41	63788-1	—
D 500 Box Straight Pin	27-23	0.86-1.15	.090 2.29	.016 0.41	.016 0.41	63278-1 <sup>3</sup>	—
	22-20	0.64-0.81	.090 2.29	.016 0.41	.016 0.41	63277-1 <sup>3</sup>	—

<sup>1</sup> Two magnet wires may be terminated in the same terminal slot if diameters are equal.

<sup>2</sup> Single magnet wire only; 22 AWG [0.64 mm] or larger.

<sup>3</sup> Varnish resist coating.

**Standard MAG-MATE Terminals** (Continued)

**110 Series  
FASTON Tab Terminals**

**Material**

Tin plated brass

**Typical Cavity Size 2**

(See page 2)



Type	Copper Magnet Wire Range <sup>1</sup>		Diode Lead		Tab Size	Stock Thickness		Strip Part Number
	AWG	mm	AWG	mm		Tab	Mag Wire	
A 300 Box Standard IDC .110 [2.79] Tab w/ Optional Diode Slot	33-31	0.18-0.23	—	—	.110 x .025 2.79 x 0.64	.025 0.64	.010 0.25	63110-1
22			0.64	.110 x .025 2.79 x 0.64	.025 0.64	.010 0.25	63376-1	

<sup>1</sup> Two magnet wires may be terminated in the same terminal slot if diameters are equal.

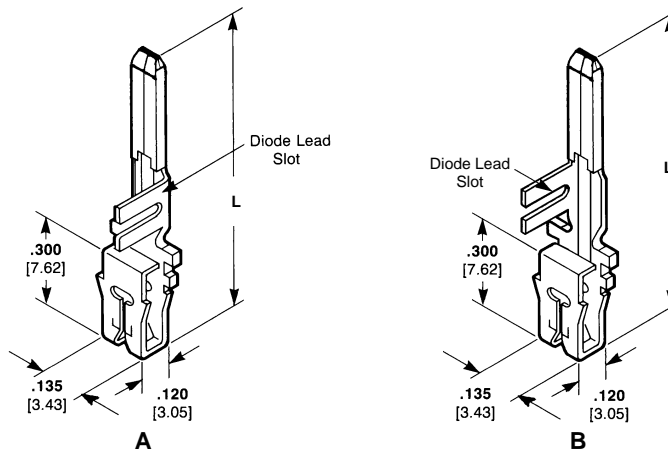

Type	Copper Magnet Wire Range <sup>1</sup>		Diode Lead		Tab Size	Dim. L	Stock Thickness		Part Number	
	AWG	mm	AWG	mm			Tab	Mag Wire	Strip	L.P.
A 300 Box Standard IDC .110 [2.79] FASTON w/ Diode Slot Offset-R.H.	31-27	0.23-0.36	22	0.64	.110 x .032 2.79 x 0.81	.965 24.51	.032 0.81	.010 0.25	63319-1†	—
			20	0.81	.110 x .032 2.79 x 0.81	.965 24.51	.032 0.81	.010 0.25	63331-1†	63434-1
	30-27	0.25-0.36	20	0.81	.110 x .032 2.79 x 0.81	.965 24.51	.032 0.81	.014 0.36	—	63529-1
			20	0.81	.110 x .032 2.79 x 0.81	.895 22.73	.032 0.81	.014 0.36	63177-1†	—
B 300 Box Standard IDC .110 [2.79] FASTON w/ Diode Slot Offset-L.H.	31-27	0.23-0.36	22	0.64	.110 x .032 2.79 x 0.81	.965 24.51	.032 0.81	.010 0.25	63276-1†	—
			20	0.81	.110 x .032 2.79 x 0.81	.965 24.51	.032 0.81	.010 0.25	63330-1†	63433-1
	30-27	0.25-0.36	20	0.81	.110 x .032 2.79 x 0.81	.965 24.51	.032 0.81	.014 0.36	—	63530-1
			20	0.81	.110 x .032 2.79 x 0.81	.895 22.73	.032 0.81	.014 0.36	63178-1†	—

<sup>1</sup> Two magnet wires may be terminated in the same terminal slot if diameters are equal.

† These part numbers are available upon special request; contact Tyco Electronics Engineering for details.

**Note:** .110 [2.79] Tab Terminals mate with compatible FASTON receptacles.  
Request AMP Catalog 82004.

Standard MAG-MATE  
Terminals

**Standard MAG-MATE Terminals** (Continued)

**110 Series  
FASTON Tab Terminals**

(Continued)

**Material**

Tin plated brass

**Typical Cavity Size 2**

(See page 2)

**Note:** .110 [2.79] Tab Terminals mate with compatible FASTON receptacles. Request AMP Catalog 82004.



Type	Copper Magnet Wire Range <sup>1</sup>		Tab Size	Stock Thickness		Part Number	
	AWG	mm		Tab	Mag Wire	Strip	L.P.
A <sup>5</sup> 300 Box Standard IDC .110 [2.79] FASTON Tab	30-27	0.25-0.36	.110 x .020 2.79 x 0.51	.020 0.51	.012 0.30	63777-1	—
	27-23	0.36-0.57	.110 x .020 2.79 x 0.51	.020 0.51	.016 0.41	63746-1	—
	23-20 <sup>2</sup>	0.45-0.64	.110 x .020 2.79 x 0.51	.020 0.51	.016 0.41	63486-1	—
B <sup>5,6</sup> 300 Box Single IDC w/ Strain Relief Slot	19-17	0.91-1.15	.110 x .020 2.79 x 0.51	.020 0.51	.020 0.51	63145-1†	—
	27-23	0.36-0.57	.110 x .020 2.79 x 0.51	.020 0.51	.016 0.41	63827-1	—
C <sup>4,5</sup> Poke-In Combination Tab	23.5-20 <sup>2</sup>	0.54-0.81	.110 x .020 2.79 x 0.51	.020 0.51	.016 0.41	1217783-1†	—
	28-24	0.32-0.51	.110 x .020 2.79 x 0.51	.020 0.51	.012 0.30	63062-1 <sup>3</sup>	1217430-1 <sup>3</sup>
	25-22 <sup>2</sup>	0.45-0.64	.110 x .020 2.79 x 0.51	.020 0.51	.012 0.30	63063-1 <sup>3</sup>	—
						63063-2	—

<sup>1</sup> Two magnet wires may be terminated in the same terminal slot if diameters are equal.  
<sup>2</sup> Single magnet wire only; 22 AWG [0.64 mm] or larger.  
<sup>3</sup> Varnish resist coating.  
<sup>4</sup> Poke-In feature accepts 20-18 AWG [0.5-0.8 mm<sup>2</sup>] Solid or overcoated stranded lead wire or 90° Poke-In tab.  
<sup>5</sup> After insertion into plastic cavity, tab portion must be bent over 45°-90° or potted in to prevent pullout when mating receptacle is disconnected.  
<sup>6</sup> Strain relief slot for high vibration applications.  
† These part numbers are available upon special request; contact Tyco Electronics Engineering for details.



**Standard MAG-MATE Terminals** (Continued)

**187 Series  
FASTON Tab Terminals**

**Material**

Tin plated brass

**Typical Cavity Sizes**

(See page 2)

Type A—Cavity Size 2



Standard MAG-MATE  
Terminals

Type	Copper Magnet Wire Range <sup>1</sup>		Dim. L	Tab Feature	Tab Size	Stock Thickness		Part Number	
	AWG	mm				Tab Section	Mag. Wire Section	Strip	L. P.
33-31	0.18-0.23	.630 16.00	.630 16.00	Dimple	.187 x .020 4.75 x 0.51	.020 0.51	.010 0.25	62513-1*	62663-1
				Hole	.187 x .020 4.75 x 0.51	.020 0.51	.012 0.30	63584-1	—
30-27	0.25-0.36	.630 16.00	.630 16.00	Dimple	.187 x .020 4.75 x 0.51	.020 0.51	.012 0.30	62512-1*	—
				Dimple	.187 x .032 4.75 x 0.81	.032 0.81	.012 0.30	63510-15.†	—
27-23	0.36-0.57	.630 16.00	.630 16.00	Dimple	.187 x .020 4.75 x 0.51	.020 0.51	.016 0.41	62514-1*	63852-1
				Hole	.187 x .020 4.75 x 0.51	.020 0.51	.016 0.41	63664-15	—
23	0.57	.630 16.00	.630 16.00	—	.187 x .020 4.75 x 0.51	.020 0.51	.016 0.41	63664-2	—
				Hole	.187 x .020 4.75 x 0.51	.020 0.51	.016 0.41	63461-1	—
22-20 <sup>2</sup>	0.64-0.81	.630 16.00	.630 16.00	—	.187 x .020 4.75 x 0.51	.020 0.51	.016 0.41	1217243-16	—
				Hole	.187 x .020 4.75 x 0.51	.020 0.51	.016 0.41	63585-1	—
21-19 <sup>3</sup> Aluminum	0.72-0.91	.630 16.00	.630 16.00	Dimple	.187 x .020 4.75 x 0.51	.020 0.51	.016 0.41	63776-1	—
				Hole	.187 x .020 4.75 x 0.51	.020 0.51	.016 0.41	62511-1*	62661-1
20-18 <sup>2</sup>	0.81-1.02	.630 16.00	.630 16.00	Dimple	.187 x .020 4.75 x 0.51	.020 0.51	.020 0.51	62511-25	—
				Hole	.187 x .020 4.75 x 0.51	.020 0.51	.020 0.51	63663-15	—
19-17 <sup>2</sup>	0.91-1.15	.630 16.00	.630 16.00	Dimple	.187 x .020 4.75 x 0.51	.020 0.51	.020 0.51	63663-2	—
				Hole	.187 x .032 4.75 x 0.81	.032 0.81	.016 0.41	1217065-1	—
18.5-16.5 <sup>3</sup> Aluminum	0.97-1.22	.630 16.00	.630 16.00	Dimple	.187 x .020 4.75 x 0.51	.020 0.51	.016 0.41	1217128-1	—
				Hole	.187 x .020 4.75 x 0.51	.020 0.51	.016 0.41	63293-1†	—
18.5-16.5 <sup>3</sup> Aluminum	0.97-1.22	.630 16.00	.630 16.00	Dimple	.187 x .020 4.75 x 0.51	.020 0.51	.020 0.51	63669-1	—
				Hole	.187 x .020 4.75 x 0.51	.020 0.51	.020 0.51	62904-17	—
18.5-16.5 <sup>3</sup> Aluminum	0.97-1.22	.630 16.00	.630 16.00	Dimple	.187 x .020 4.75 x 0.51	.020 0.51	.020 0.51	63670-1	—
				Hole	.187 x .020 4.75 x 0.51	.020 0.51	.020 0.51	63273-1	63829-1
18.5-16.5 <sup>3</sup> Aluminum	0.97-1.22	.630 16.00	.630 16.00	Dimple	.187 x .020 4.75 x 0.51	.020 0.51	.020 0.51	63511-15	—
				Hole	.187 x .020 4.75 x 0.51	.020 0.51	.020 0.51	63665-15	—
18.5-16.5 <sup>3</sup> Aluminum	0.97-1.22	.630 16.00	.630 16.00	Dimple	.187 x .020 4.75 x 0.51	.020 0.51	.016 0.41	63494-1†	—
				Hole	.187 x .020 4.75 x 0.51	.020 0.51	.016 0.41	63668-1	—

<sup>1</sup> Two magnet wires may be terminated in the same terminal slot if diameters are equal.  
<sup>2</sup> Single magnet wire only.  
<sup>3</sup> Single aluminum magnet wire only.  
<sup>4</sup> After insertion into plastic cavity, tab portion must be bent over 45°-90° or potted in to prevent pullout when mating receptacle is disconnected.  
<sup>5</sup> Varnish resist coating.  
<sup>6</sup> Special wide body cut off for added stability.  
<sup>7</sup> Single bare copper wire only.  
 \* Recognized under the Component Program of Underwriters Laboratories, Inc.  
 † These part numbers are available upon special request; contact Tyco Electronics Engineering for details.

**Note:** .187 [4.75] Tab Terminals mate with compatible FASTON receptacles. Request AMP Catalog 82004.

Chart continued on next page

Dimensions are in inches and millimeters unless otherwise specified. Values in brackets are metric equivalents.

Dimensions are shown for reference purposes only. Specifications subject to change.

Technical Support  
USA: 1-800-522-6752  
Canada: 1-905-475-6222  
Mexico: 01-800-733-8926

www.tycoelectronics.com

### Standard MAG-MATE Terminals (Continued)

#### 187 Series FASTON Tab Terminals

(Continued)

#### Material

Tin plated brass

#### Typical Cavity Sizes

(See page 2)

Type B—Cavity Size 5

Type C—Cavity Size 5

Type D—Cavity Size 3



#### 187 Series Combination Poke-In FASTON Terminals

#### Material

Tin plated brass

#### Typical Cavity Sizes

(See page 2)

Type E—Cavity Size 2

Type F—Cavity Size 3

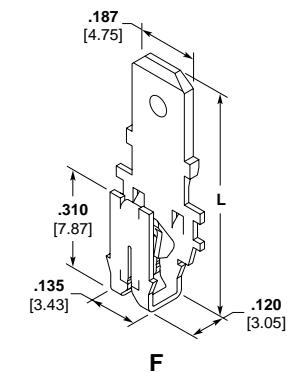

Type	Copper Magnet Wire Range <sup>1</sup>		Dim. L	Tab Feature	Tab Size	Stock Thickness		Strip Part Number
	AWG	mm				Tab Section	Mag. Wire Section	
B 300 Box Standard IDC Narrow Body Latch Type	33-31	0.18-0.23	.630 16.00	Hole	.187 x .020 4.75 x 0.51	.020 0.51	.010 0.25	63108-1†
	31-28	0.23-0.32	.630 16.00	Hole	.187 x .020 4.75 x 0.51	.020 0.51	.010 0.25	62743-1†
	30-27	0.25-0.36	.630 16.00	Hole	.187 x .020 4.75 x 0.51	.020 0.51	.012 0.30	63109-1†
	27-23	0.36-0.57	.630 16.00	Hole	.187 x .020 4.75 x 0.51	.020 0.51	.016 0.41	63107-1
	—	—	.630 16.00	—	.187 x .020 4.75 x 0.51	.020 0.51	.016 0.41	1217493-1
	23-20 <sup>2</sup>	0.57-0.81	.630 16.00	Hole	.187 x .020 4.75 x 0.51	.020 0.51	.016 0.41	63340-1
	—	—	.630 16.00	—	.187 x .020 4.75 x 0.51	.020 0.51	.016 0.41	1217493-1
	22-20 <sup>2</sup>	0.64-0.81	.630 16.00	Hole	.187 x .020 4.75 x 0.51	.020 0.51	.016 0.41	63429-1 63429-2 <sup>6</sup>
	19-17 <sup>2</sup>	0.91-1.15	.630 16.00	Dimple	.187 x .020 4.75 x 0.51	.020 0.51	.016 0.41	62888-1 62888-2 <sup>6</sup>
	—	—	.630 16.00	Hole	.187 x .020 4.75 x 0.51	.020 0.51	.016 0.41	63782-1
18 lead <sup>2</sup>	0.80-0.92 mm <sup>2</sup>	.630 16.00	—	.187 x .020 4.75 x 0.51	.020 0.51	.016 0.41	1217592-1†	
C <sup>3</sup> Narrow Body Latch Type w/ Strain Relief Slot	23.5-20 <sup>2</sup>	0.54-0.81	.630 16.00	Dimple	.187 x .020 4.75 x 0.51	.020 0.51	.016 0.41	1217004-1
	33-31	0.18-0.23	.630 16.00	Dimple	.187 x .020 4.75 x 0.51	.020 0.51	.010 0.25	63255-1 63544-1†
D 300 Box Standard IDC Wide Body Latch Type	33-31	0.18-0.23	.730 18.54	Hole	.187 x .020 4.75 x 0.51	.020 0.51	.010 0.25	63505-1
	31-28	0.23-0.32	.630 16.00	Hole	.187 x .020 4.75 x 0.51	.020 0.51	.012 0.30	63760-1
	30-27	0.25-0.36	.630 16.00	Dimple	.187 x .020 4.75 x 0.51	.020 0.51	.012 0.30	63254-1† 63478-1†
	—	—	.730 18.54	Hole	.187 x .020 4.75 x 0.51	.020 0.51	.012 0.30	63447-1
	27-23	0.36-0.57	.630 16.00	Dimple	.187 x .020 4.75 x 0.51	.020 0.51	.016 0.41	63256-2
E <sup>4,5</sup> Poke-In Combination Tab	33-31	0.81-0.23	.630 16.00	Hole	.187 x .020 4.75 x 0.51	.020 0.51	.010 0.25	63018-1
F <sup>4</sup> Poke-In Combination Tab Wide Body Latch Type	28-24	0.32-0.51	.630 16.00	Hole	.187 x .032 4.75 x 0.81	.032 0.51	.016 0.41	1217857-1†

<sup>1</sup> Two magnet wires may be terminated in the same terminal slot if diameters are equal.

<sup>2</sup> Single magnet wire only; 22 AWG [0.64 mm] or larger.

<sup>3</sup> Strain relief slot for high vibration applications.

<sup>4</sup> Poke-In feature accepts 20-18 AWG [0.5-0.8 mm<sup>2</sup>] solid, fused stranded lead wire or 90° poke-in tab terminal.

<sup>5</sup> After insertion into plastic cavity, tab portion must be bent over 45°-90° or potted in to prevent pullout when mating receptacle is disconnected.

<sup>6</sup> Splice free reeling.

† These part numbers are available upon special request; contact Tyco Electronics Engineering for details.

**Note:** .187 [4.75] Tab Terminals mate with compatible FASTON receptacles. Request AMP Catalog 82004.

Chart continued on next page

**Standard MAG-MATE Terminals** (Continued)

**187 Series  
FASTON Tab Terminals**  
(Continued)

**Material**

Tin plated brass

**Typical Cavity Sizes**

(See page 2)

Type G—Cavity Size 4

Type H—Cavity Size 4

Type J—Cavity Size 4



Standard MAG-MATE  
Terminals

Type	Copper Magnet Wire Range <sup>1</sup>		Dim. L	Tab Feature	Tab Size	Stock Thickness		Part Number		
	AWG	mm				Tab Section	Mag. Wire Section	Strip	L. P.	
G <sup>3</sup> 500 Box Standard IDC	22-20	0.64-0.81	.830 21.08	Dimple	.187 x .020 4.75 x 0.51	.020 0.51	.020 0.51	—	63708-14	
	19-17	0.91-1.15	.830 21.08	Hole	.187 x .020 4.75 x 0.51	.020 0.51	.020 0.51	63643-1	—	
				Hole	.187 x .020 4.75 x 0.51	.020 0.51	.020 0.51	63667-14	63599-14	
	17.5-16	1.09-1.29	.830 21.08	Hole	.187 x .020 4.75 x 0.51	.020 0.51	.020 0.51	63427-1†	—	
				Hole	.187 x .032 4.75 x 0.81	.032 0.81	.020 0.51	1217075-1	—	
	16-15	1.29-1.45	.830 21.08	Hole	.187 x .020 4.75 x 0.51	.020 0.51	.020 0.51	63666-14	—	
				Dimple	.187 x .020 4.75 x 0.51	.020 0.51	.020 0.51	63353-1	—	
	14.5-13 <sup>2</sup>	1.54-1.83	.830 21.08	Dimple	.187 x .020 4.75 x 0.51	.020 0.51	.016 0.41	63428-1	—	
	H <sup>3,5</sup> 500 Box Single IDC w/ Strain Relief Slot	27-23	0.36-0.57	.830 21.08	Hole	.187 x .020 4.75 x 0.51	.020 0.51	.020 0.51	1217042-1	—
		22-20	0.64-0.81	.830 21.08	Hole	.187 x .020 4.75 x 0.51	.020 0.51	.020 0.51	63983-1	—
Hole					.187 x .032 4.75 x 0.81	.032 0.81	.020 0.51	1217339-1	—	
19-17		0.91-1.15	.830 21.08	Hole	.187 x .020 4.75 x 0.51	.020 0.51	.020 0.51	63995-1	—	
				Hole	.187 x .032 4.75 x 0.81	.032 0.81	.020 0.51	1217090-1	—	
16-15	1.29-1.45	.830 21.08	Hole	.187 x .020 4.75 x 0.51	.020 0.51	.020 0.51	63996-1	—		
J 500 Box Standard IDC Latch Type	22-20	0.64-0.81	.830 21.08	—	.187 x .020 4.75 x 0.51	.020 0.51	.020 0.51	1217491-1	—	
	19-17	0.91-1.15	.830 21.08	—	.187 x .020 4.75 x 0.51	.020 0.51	.020 0.51	1217492-1	—	

<sup>1</sup> Two magnet wires may be terminated in the same terminal slot if diameters are equal.

<sup>2</sup> Single magnet wire only.

<sup>3</sup> After insertion into plastic cavity, tab portion must be bent over 45°-90° or potted in to prevent pullout when mating receptacle is disconnected.

<sup>4</sup> Varnish resist coating.

<sup>5</sup> Strain relief slot for high vibration applications.

† These part numbers are available upon special request; contact Tyco Electronics Engineering for details.

## Standard MAG-MATE Terminals (Continued)

### 250 Series FASTON Tab Terminals

#### Material

Tin plated brass

#### Typical Cavity Sizes

(See page 2)

Type A—Use Cavity Size 2

Type B—Use Cavity Size 5

Type C—Use Cavity Size 3



**Note:** .250 [6.35] tab terminals mate with compatible FASTON receptacles. Request AMP Catalog 82004.

### 250 Series Combination Poke-In FASTON Tab Terminal

#### Material

Tin plated brass

#### Typical Cavity Sizes 3 (Type D)

(See page 2)

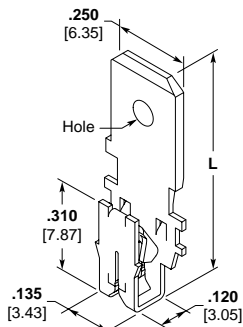

Type	Copper Magnet Wire Range <sup>1</sup>		Dim. L	Tab Feature	Tab Size	Stock Thickness		Part Number		
	AWG	mm				Tab Section	Mag. Wire Section	Strip	L. P.	
A3 300 Box Standard IDC .250 [6.35] FASTON Tab	33-31	0.18-0.23	.750 19.05	Dimple	.250 x .032 6.35 x 0.81	.032 0.81	.010 0.25	62600-1*	62655-1	
	30-27	0.25-0.36	.750 19.05	Dimple Hole Dimple & Hole	.250 x .032 6.35 x 0.81	.032 0.81	.012 0.30	62651-1* 63055-1† 63328-1	62656-1†	
	28-24	0.32-0.51	.750 19.05	Hole	.250 x .032 6.35 x 0.81	.032 0.81	.016 0.41	63607-1	—	
	27-23	0.36-0.57	.750 19.05	Dimple Dimple Dimple Dimple Hole	.250 x .032 6.35 x 0.81	.032 0.81	.016 0.41	62652-17* 62652-26.7 62939-13.4† 63920-17.9 63159-17.†	62657-1	
	22-20 <sup>2</sup>	0.64-0.81	.750 19.05	Dimple	.250 x .032 6.35 x 0.81	.032 0.81	.016 0.41	62653-1* 62653-27 62653-36	62658-1 1217031-17	
	20-18 <sup>2</sup> Bare Wire	0.81-1.02	.750 19.05	Dimple	.250 x .032 6.35 x 0.81	.032 0.81	.020 0.51	63200-1	—	
	33-31	0.18-0.23 <sup>1</sup>	.750 19.05	Dimple	.250 x .032 6.35 x 0.81	.032 0.81	.010 0.25	63026-1†	—	
	30-27	0.25-0.36 <sup>1</sup>	.750 19.05	Dimple	.250 x .032 6.35 x 0.81	.032 0.81	.012 0.30	63027-1†	—	
	27-23	0.36-0.57	.750 19.05	Dimple	.250 x .032 6.35 x 0.81	.032 0.81	.016 0.41	1217860-1†	—	
	23-20 <sup>2</sup>	0.57-0.81	.750 19.05	Dimple	.250 x .032 6.35 x 0.81	.032 0.81	.016 0.41	1217870-1†	—	
C Wide Body Latch Type	33-31	0.18-0.23	.750 19.05	Dimple Hole Hole Hole	.250 x .032 6.35 x 0.81	.032 0.81	.010 0.25	63133-1 63309-1 63309-27 63618-18	—	
	31-28	0.23-0.32	.750 19.05	Dimple	.250 x .032 6.35 x 0.81	.032 0.81	.012 0.30	63403-2†	—	
	30-28	0.25-0.32	.750 19.05	Hole	.250 x .032 6.35 x 0.81	.032 0.81	.012 0.30	1217152-1	—	
	30-27	0.25-0.36	.750 19.05	Dimple Dimple Dimple Hole Hole	.250 x .032 6.35 x 0.81	.032 0.81	.012 0.30	63132-1 63132-2 <sup>10</sup> 63132-3 <sup>4</sup> 63499-1 63499-27	63203-1†	
	27-23	0.36-0.57	.750 19.05	Hole Hole Dimple Dimple	.250 x .032 6.35 x 0.81	.032 0.81	.016 0.41	63571-1 63571-27 63128-1 63128-3 <sup>7</sup>	63207-1†	
	22-20 <sup>2</sup>	0.64-0.81	.750 19.05	Dimple	.250 x .032 6.35 x 0.81	.032 0.81	.016 0.41	63601-1 63601-27	—	
	19-17 <sup>2</sup>	0.91-1.15	.750 19.05	Hole	.250 x .032 6.35 x 0.81	.032 0.81	.016 0.41	63614-1	—	
	D5 Poke-In Combination Tab Wide Body Latch Type	28-24	0.32-0.51	.750 19.05	Hole	.250 x .032 6.35 x 0.81	.032 0.81	.016 0.41	1217856-2†	—

<sup>1</sup> Two magnet wires may be terminated in the same terminal slot if diameters are equal.  
<sup>2</sup> Single magnet wire only; 22 AWG [0.64 mm] or larger.  
<sup>3</sup> After insertion into plastic holder, tab portion must be bent over 45°-90° or potted in to prevent pullout when mating receptacle is disconnected.  
<sup>4</sup> Varnish resist coating.  
<sup>5</sup> Poke-In feature accepts 20-18 AWG [0.5-0.8 mm<sup>2</sup>] solid, fused stranded lead wire or 90° Poke-In tab

terminal.  
<sup>6</sup> Reverse reeled version of -1.  
<sup>7</sup> Half hard temper brass.  
<sup>8</sup> Special key hole wire slot block.  
<sup>9</sup> Special wide neck design.  
<sup>10</sup> Material is unplated brass.  
 † These part numbers are available upon special request; contact Tyco Electronics Engineering for details.  
 \* Recognized under the Component Program of

Chart continued on next page

**Standard MAG-MATE Terminals** (Continued)

**250 Series  
FASTON Tab Terminals**

(Continued)

**Material**

Tin plated brass

**Typical Cavity Sizes**

(See page 2)

Type E—Use Cavity Size 4

Type F—Use Cavity Size 4



Type	Copper Magnet Wire Range <sup>1</sup>		Dim. L	Tab Feature	Tab Size	Stock Thickness		Part Number	
	AWG	mm				Tab Section	Mag. Wire Section	Strip	L. P.
E <sub>3</sub> 500 Box Standard IDC Wide Neck	22-20	0.64-0.81	.952 24.18	Hole	.250 x .032 6.35 x 0.81	.032 0.81	.020 0.51	63495-14	63882-1
	19-17	0.91-1.15	.952 24.18	Hole	.250 x .032 6.35 x 0.81	.032 0.81	.020 0.51	63464-2† 63464-3 <sup>4</sup>	— 63598-1
	16-15	1.29-1.45	.952 24.18	Hole	.250 x .032 6.35 x 0.81	.032 0.81	.020 0.51	63459-2 63459-3 <sup>4</sup>	63881-1 —
	14-13 <sup>2</sup>	1.61-1.83	.952 24.18	Dimple	.250 x .032 6.35 x 0.81	.032 0.81	.020 0.51	63460-14,† —	63883-1 1217588-1†
				Hole	.250 x .032 6.35 x 0.81	.032 0.81	.020 0.51	63816-1 63816-2 <sup>4</sup>	— —
F <sub>3</sub> 500 Box Standard IDC Narrow Neck	22-20	0.64-0.81	.952 24.18	Dimple	.250 x .032 6.35 x 0.81	.032 0.81	.020 0.51	63155-14	63336-1†
	19-17	0.91-1.15	.952 24.18	Dimple	.250 x .032 6.35 x 0.81	.032 0.81	.020 0.51	62923-14 62923-24, <sup>5</sup> 62923-34, <sup>6</sup>	— — —
	16-15	1.29-1.45	.952 24.18	Dimple	.250 x .032 6.35 x 0.81	.032 0.81	.020 0.51	63064-14	63263-1†
	14-13 <sup>2</sup>	1.61-1.83	.952 24.18	Dimple	.250 x .032 6.35 x 0.81	.032 0.81	.020 0.51	63465-1 63371-14	— —
				12 <sup>2</sup>	2.05	.952 24.18	Dimple	.250 x .032 6.35 x 0.81	.032 0.81

<sup>1</sup> Two magnet wires may be terminated in the same terminal slot if diameters are equal.

<sup>2</sup> Single magnet wire only.

<sup>3</sup> After insertion into plastic holder, tab portion must be bent over 45°-90° or potted in to prevent pullout when mating receptacle is disconnected.

<sup>4</sup> Varnish resist coating.

<sup>5</sup> Box-up reversed reel version of -1.

<sup>6</sup> Box-up reeled version of -1.

† These part numbers are available upon special request; contact Tyco Electronics Engineering for details.

## Slim Line MAG-MATE Terminals

### Product Facts

- Terminates all magnet wire film insulations
- Eliminates need for pre-stripping conductors
- Eliminates need to post insulate termination
- Excess magnet wire is automatically trimmed during the termination process
- Series 187 and 250 Tab terminals available
- Terminates 33-17 AWG [0.18-1.15 mm] magnet wire
- Simultaneously terminates two magnet wires of the same size in one terminal from 33-23 AWG [0.18-0.57 mm]
- Available in strip form for semi-automatic or fully automatic insertions
- Available in loose piece form for hand tool insertions
- Varnish resist tab terminals are available for special applications
- High speed, fully automated integrated systems provide uniform terminations reliability at the lowest possible applied cost
- Clean metal-to-metal interface produces stable, gas-tight electrical terminations free of oxides and other contaminants
- Recognized under the Component Recognition Program of Underwriters Laboratories Inc., File No. E13288 

### Applications

- Motor windings and connections
- Coil Connections
- Transformer windings and connections
- Bobbin connections
- Lighting Ballasts
- Power Supplies

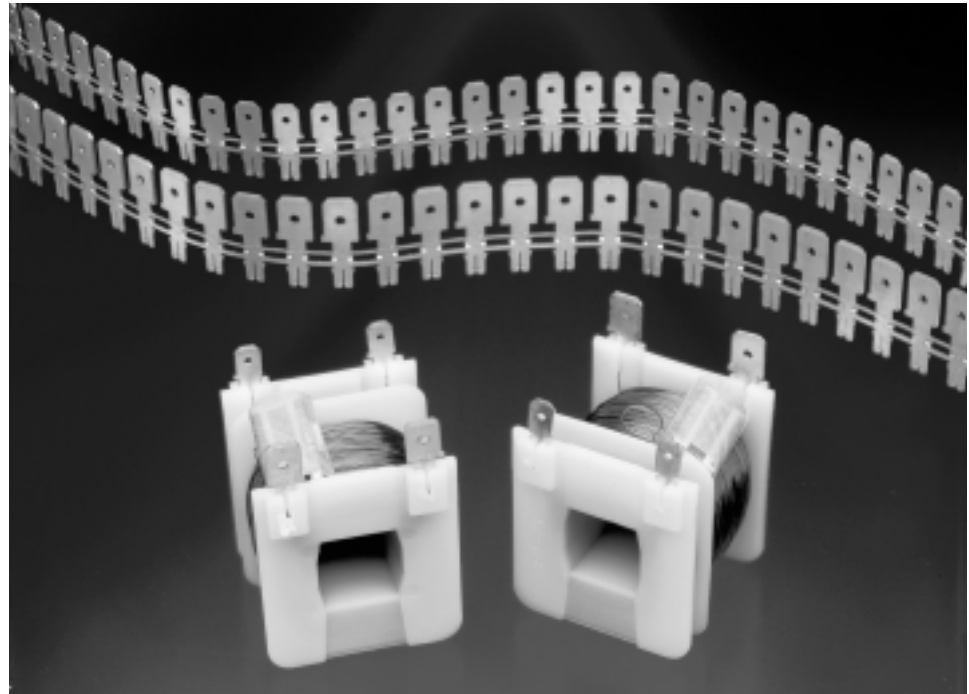

Tyco Electronics offers a full selection of Series 187 and 250 Slim Line MAG-MATE Tab insulation displacement (IDC) terminals for magnet wire terminations.

Slim Line MAG-MATE Series 187 and 250 tab terminals with a single IDC slot terminate 33-17 AWG [0.18 to 1.15 mm].

Each IDC slot terminates up to four consecutive magnet wire ranges.

Two magnet wires with the same diameter can be terminated in one terminal down to 23 AWG [0.57 mm].

According to Tyco Electronics specifications MAG-MATE cavities are either integrated into coil bodies or especially designed cavity housings. The magnet wires are precisely positioned in the "U" shaped designed termination slots.

The MAG-MATE Inserter cuts the terminals from the strip and places the terminals over the magnet wire into the plastic cavities.

During this operation the small stripping devices penetrate the film insulation from the magnet wire.

Residual spring energy in the terminal causes the side walls of each IDC slot to function as opposing cantilever beams.

This constant pressure results in an intimate metal-to-metal interface, providing a reliable, long-term connection.

The wiping action between the wire and terminals removes oxides or other contaminants present on both the conductor and the terminal slot side walls, producing a clean, stable, gas-tight electrical termination.

The AMP MAG-MATE Inserter may be used as a semi-automatic bench machine or integrated in production lines for fully-automatic applications.

### Typical Plastic Cavity

Not for design, Tyco Electronics will supply required dimensions of cavity for each customer application.

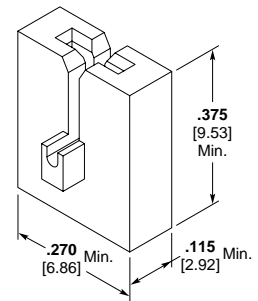

Reference Application  
Spec. 114-2147

### Technical Documents

**Application Specifications** describe requirements for using the product in its intended application and or crimping information. They are intended for the Packaging and Design Engineer and the Machine Setup Person.

114-2140—Slim Line  
MAG-MATE  
Terminals

**Slim Line MAG-MATE Terminals** (Continued)

**187 Series  
FASTON Tab Terminals**

**Material**

Tin Plated Brass



Type	Copper Magnet Wire Range <sup>1</sup>		Dim. L	Tab Feature	Tab Size	Stock Thickness		Part Number	
	AWG	mm				Tab Section	Mag. Wire Section	Strip	L. P.
33-31	0.18-0.23	.630 16.00	16.00	Hole	.187 x .020 4.75 x 0.51	.020 0.51	.012 0.30	63710-2	—
				Dimple	.187 x .032 4.75 x 0.81	.032 0.81	.012 0.30	63738-2	—
30-28	0.25-0.32	.630 16.00	16.00	Hole	.187 x .020 4.75 x 0.51	.020 0.51	.012 0.30	63711-2	—
				Dimple	.187 x .032 4.75 x 0.81	.032 0.81	.012 0.30	63737-2	—
27-24	0.36-0.51	.630 16.00	16.00	Hole	.187 x .020 4.75 x 0.51	.020 0.51	.016 0.41	63712-2	—
				Dimple	.187 x .032 4.75 x 0.81	.032 0.81	.016 0.41	63736-2	—
23-20 <sup>2</sup>	0.57-0.81	.760 19.31	19.31	Plain	.187 x .020 4.75 x 0.51	.020 0.51	.016 0.41	1217497-1	—
				Hole	.187 x .032 4.75 x 0.81	.032 0.81	.016 0.41	1217497-2 <sup>3</sup>	—
19-17 <sup>2</sup>	0.91-1.15	.630 16.00	16.00	Hole	.187 x .020 4.75 x 0.51	.020 0.51	.016 0.41	63713-2	1217714-1
				Dimple	.187 x .032 4.75 x 0.81	.032 0.81	.016 0.41	63735-2	—
19-17 <sup>2</sup>	0.91-1.15	.630 16.00	16.00	Hole	.187 x .020 4.75 x 0.51	.020 0.51	.016 0.41	63714-2	—
				Dimple	.187 x .032 4.75 x 0.81	.032 0.81	.016 0.41	63734-2	—

<sup>1</sup> Two magnet wires may be terminated in the same terminal slot if diameters are equal.  
<sup>2</sup> Single magnet wire only; 22 AWG [0.64] or larger.  
<sup>3</sup> Reverse reeled version of -1.

**250 Series  
FASTON Tab Terminals**

**Material**

Tin Plated Brass

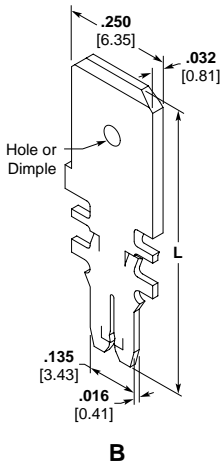

Type	Copper Magnet Wire Range <sup>1</sup>		Dim. L	Tab Feature	Tab Size	Stock Thickness		Strip Part Number
	AWG	mm				Tab Section	Mag. Wire Section	
33-31	0.18-0.23	.752 19.10	19.10	Hole	.250 x .032 6.35 x 0.81	.032 0.81	.012 0.30	63716-2
				Dimple	.250 x .032 6.35 x 0.81	.032 0.81	.012 0.30	63744-2
30-28	0.25-0.32	.752 19.10	19.10	Hole	.250 x .032 6.35 x 0.81	.032 0.81	.012 0.30	63717-2
				Dimple	.250 x .032 6.35 x 0.81	.032 0.81	.012 0.30	63743-2
27-24	0.36-0.51	.752 19.10	19.10	Hole	.250 x .032 6.35 x 0.81	.032 0.81	.016 0.41	63718-2
				Dimple	.250 x .032 6.35 x 0.81	.032 0.81	.016 0.41	63742-2
23-20 <sup>2</sup>	0.57-0.81	.752 19.10	19.10	Hole	.250 x .032 6.35 x 0.81	.032 0.81	.016 0.41	63719-2
				Dimple	.250 x .032 6.35 x 0.81	.032 0.81	.016 0.41	63741-2
19-17 <sup>2</sup>	0.91-1.15	.752 19.10	19.10	Hole	.250 x .032 6.35 x 0.81	.032 0.81	.016 0.41	63720-2
				Dimple	.250 x .032 6.35 x 0.81	.032 0.81	.016 0.41	63740-2

<sup>1</sup> Two magnet wires may be terminated in the same terminal slot if diameters are equal.  
<sup>2</sup> Single magnet wire only; 22 AWG [0.64] or larger.

**Slim Line MAG-MATE Terminals** (Continued)

**Tab Terminals**

**Material**

Tin Plated Brass



Type	Copper Magnet Wire Range <sup>1</sup>		Dim. L	Diode Size	Tab Size	Stock Thickness		Strip Part Number
	AWG	mm				Tab Section	Mag. Wire Section	
C Combination Diode Slot/Tab	33-31	0.18-0.23	.725 18.42	#20 0.8	.059 x .032 1.50 x 0.81	0.032 0.81	0.012 0.30	63888-1
	33-31	0.18-0.23	.725 18.42	#22.5 0.6	.059 x .032 1.50 x 0.81	0.032 0.81	0.012 0.30	63903-1
	33-31	0.18-0.23	.760 19.29	#22.5 0.6	.059 x .032 1.50 x 0.81	0.032 0.81	0.012 0.30	1217709-1

<sup>1</sup> Two magnet wires may be terminated in the same terminal slot if diameters are equal.





### Mini MAG-MATE Terminals

#### Product Facts

- Terminates all fine gauge magnet wire film insulations
- Eliminates need to pre-stripping conductors
- Eliminates need to post insulate termination
- Terminates 52-30 AWG [0.254-0.0198 mm] diameter copper magnet wire
- Poke-In leaf style accepts 22 -18 AWG [0.3-0.9 mm] overcoated stranded or solid lead wire
- Available in strip form for semi-automatic or fully automatic insertions
- Available in both open and closed cavity systems
- High speed, fully automated integrated systems provide uniform terminations reliability at the lowest possible applied cost
- Recognized under the Component Recognition Program of Underwriters Laboratories Inc, File No. E13288 

#### Applications

- Ignition coils
- Small motors
- Synchronist timers
- Electric meter coils
- Solenoids
- Relays



Tyco Electronics offer AMP Mini MAG-MATE poke-in, crimp wire barrel, post and quick disconnect tab insulation displacement (IDC) terminals for fine gauge magnet wire terminations.

Mini MAG-MATE terminals are designed to terminate 52-30 AWG [0.254-0.198 mm] diameter copper magnet wire; poke-in leaf terminals accept 22-18 AWG [0.3-0.9 mm<sup>2</sup>] overcoated stranded or solid lead wire.

The terminal design uses the AMPLIVAR serrated burr technology to penetrate the film insulation of copper magnet wire.

Mini MAG-MATE cavity pockets, designed to Tyco Electronics specifications, include a wire receiving slot and wire tie-off post that is either integrated into coil bodies or specially designed cavity housings.

The magnet wire is wrapped around the tie-off post and placed across the cavity slot. After the coil is wound, the finish end of the magnet wire is dressed through the second cavity slot and tied to its tie-off post.

The Mini MAG-MATE Inserter shears the terminal from the carrier strip and insert the terminal into the cavity by a dual ram insertion mechanism.

As the unexpanded terminal approaches the bottom of the cavity the upper ram stops. The lower ram continues to push to a prescribed depth to expand the terminal and complete the termination process.

The fully seated terminal fits squarely into the cavity, while the serrated leg of the terminal cams against the pre-positioned magnet wire to penetrate the film insulation and provide a stable electrical termination.

#### Typical Plastic Cavity

Not for design, Tyco Electronics will supply required dimensions of cavity for each customer application.

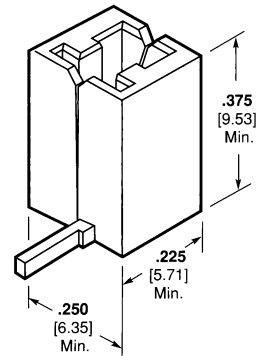

Reference Application Spec. 114-2047

#### Technical Documents

**Application Specifications** describe requirements for using the product in its intended application and or crimping information. They are intended for the Packaging and Design Engineer and the Machine Setup Person.

114-2047—Mini MAG-MATE Terminals

**Mini MAG-MATE Terminals** (Continued)

Termination Sequence

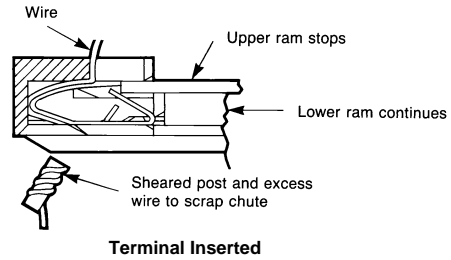
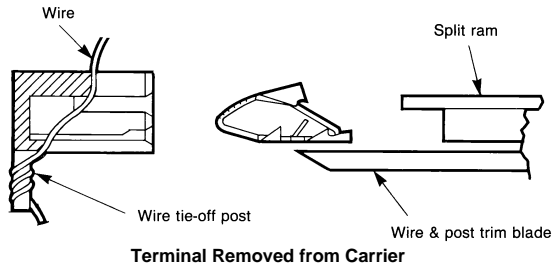

Poke-In Tab Terminal

Material

.010 [0.25] tin plated brass

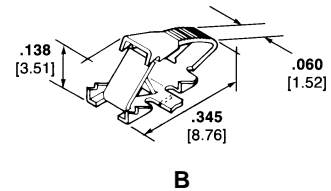
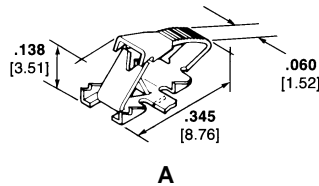

Type	Copper Magnet Wire Range		Lead Wire Range <sup>1</sup>		Mating Tab	Stock Thickness		Strip Part Number
	AWG	mm	AWG	mm <sup>2</sup>		Poke-In Beam	Mag Wire	
A Lead Wire Poke-In	52-42	0.02-0.06	22-18	0.3-0.9	—	<b>0.010</b> 0.25	<b>0.010</b> 0.25	62781-1
	44-36	0.05-0.13	22-18	0.3-0.9	—	<b>0.010</b> 0.25	<b>0.010</b> 0.25	62780-1
	38-30	0.10-0.25	22-18	0.3-0.9	—	<b>0.010</b> 0.25	<b>0.010</b> 0.25	62606-1
B Tab Poke-In	52-42	0.02-0.06	—	—	<b>.050 x .020</b> 1.27 x 0.51	<b>0.010</b> 0.25	<b>0.010</b> 0.25	63613-1 <sup>3</sup>
	44-36	0.05-0.13	—	—	<b>.060 x .020</b> 1.52 x 0.51	<b>0.010</b> 0.25	<b>0.010</b> 0.25	63795-1 <sup>2</sup> 63845-1 <sup>2,3</sup>
	38-30	0.10-0.25	—	—	<b>.060 x .020</b> 1.52 x 0.51	<b>0.010</b> 0.25	<b>0.010</b> 0.25	63844-1 <sup>2,3</sup>

<sup>1</sup> Solid or overcoated stranded lead wire only.

<sup>2</sup> Radius on beam leaf tip.

<sup>3</sup> Finish is select gold plated on lead tip.

### Mini MAG-MATE Terminals (Continued)

#### Posted Terminal

#### Material

Tin over premilled brass



Type	Copper Magnet Wire Range		Post Size	Stock Thickness		Strip Part Number
	AWG	mm		Post	Mag Wire	
A PCB Post	44-36	0.05-0.13	.024 x .020 0.62 x 0.51	.020 0.51	.010 0.25	1217804-1†
	38-30	0.10-0.25	.024 x .020 0.62 x 0.51	.020 0.51	.010 0.25	63675-4
B Solder Post	44-36	0.05-0.13	.150 x .020 3.81 x 0.51	.020 0.51	.010 0.25	63955-1
	38-30	0.10-0.25	.150 x .020 3.81 x 0.51	.020 0.51	.010 0.25	63956-1
C Wire Wrap Post	38-30	0.10-0.25	.070 x .020 1.78 x 0.51	.020 0.51	.010 0.25	63041-1

† These part numbers are available upon special request; contact Tyco Electronics Engineering for details.

#### FASTON Tab Terminals

#### Material

Tin over premilled brass



Type	Copper Magnet Wire Range		Tab Size	Stock Thickness		Strip Part Number
	AWG	mm		Post	Mag Wire	
A .110 [2.79] FASTON Tab	38-30	0.10-0.25	.110 x .020 2.79 x 0.51	.020 0.51	.010 0.25	63161-1
	44-36	0.05-0.13	.187 x .020 4.75 x 0.51	.020 0.51	.010 0.25	63778-1
B .187 [4.75] FASTON Tab	38-30	0.10-0.25	.187 x .020 4.75 x 0.51	.020 0.51	.010 0.25	62816-1 1217529-1
	44-36	0.05-0.13	.250 x .032 6.35 x 0.81	.032 0.81	.010 0.25	1217000-1
C .250 [6.35] FASTON Tab	38-30	0.10-0.25	.250 x .032 6.35 x 0.81	.032 0.81	.010 0.25	63999-1

#### Crimp Wire Barrel Terminal

#### Material

Tin plated brass



Type	Copper Magnet Wire Range		Lead Wire Range		Stock Thickness		Strip Part Number
	AWG	mm	AWG	mm <sup>2</sup>	Crimp Barrel	Mag Wire	
A Crimp Wire Barrel	52-42	0.02-0.06	26-22	0.12-0.30	.010 0.25	.010 0.25	63828-1
	44-36	0.05-0.13	26-22	0.12-0.30	.010 0.25	.010 0.25	1217830-1†
	38-30	0.10-0.25	22-18	0.3-0.9	.010 0.25	.010 0.25	63199-1† 1217231-1†

1 Wire and insulation barrel reversed so lead wire exits over magnet wire termination area.

† These part numbers are available upon special request; contact Tyco Electronics Engineering for details.

Mini MAG-MATE  
Terminals

## SIAMEZE Terminals

### Product Facts

- Terminates all copper magnet wire film insulations
- Eliminates need for pre-stripping conductors
- Moving Beam contact design connects a wide range of magnet wire sizes with a single terminal
- Standard range terminals connect 34-18 AWG [0.16-1.0 mm] magnet wire
- Fine range terminals connect 36-27 AWG [0.13-0.38 mm] magnet wire
- Medium range terminals connect 23-12 AWG [0.56-2.03 mm] magnet wire
- Excess magnet wire is automatically trimmed during the termination process
- Available in strip form for semi-automatic or fully automatic insertions
- Loose piece terminals available for hand tool insertions
- High-speed automatic coil winding machine terminations provide uniform reliability at the lowest possible applied cost
- Clean metal-to-metal interface produces stable, gas-tight electrical terminations free of oxides and other contaminants
- Recognized under the Component Program of Underwriters Laboratories Inc., File No. E13288 

### Applications

- Motor windings and connections
- Coil connections
- Transformer windings and connections
- Ballasts
- Power supplies
- Solenoids
- Actuators

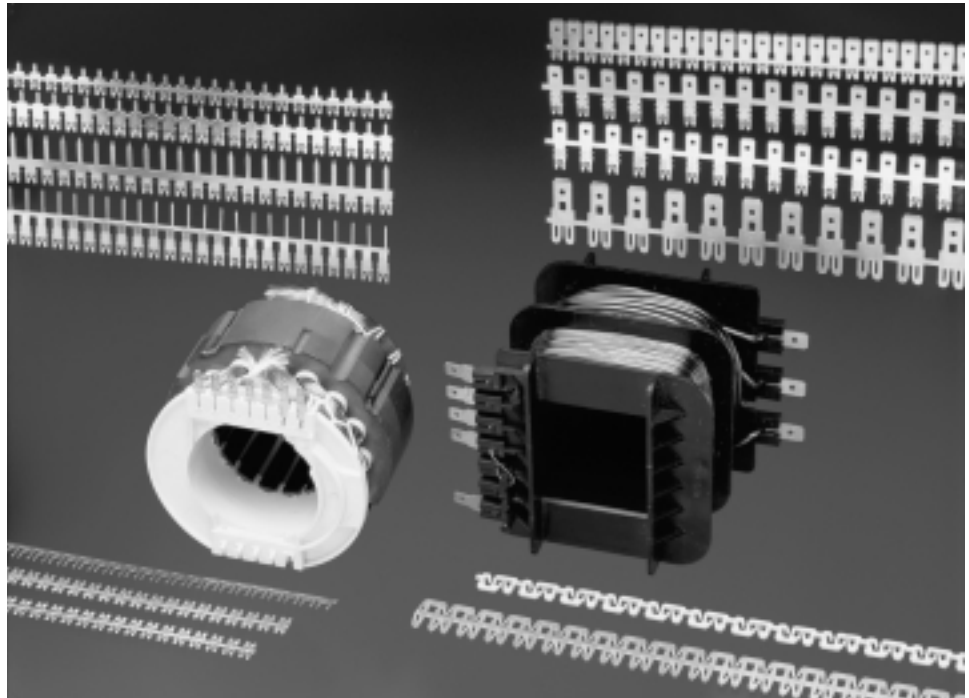

Tyco Electronics offers a full selection of AMP SIAMEZE insulation displacement (IDC) terminals for interconnecting copper magnet wires, lead wires, and other components.

The AMP SIAMEZE insulation displacement (IDC) technology eliminates the need to strip the film insulation from copper magnet wires and lead wires.

Terminals are available in wire-to-wire, Lead Lok, quick disconnect tabs, posts, pin and receptacle terminals.

Standard Range SIAMEZE terminals terminate 34-18 AWG [0.16-1.0 mm] copper magnet wires.



Fine Range SIAMEZE terminals terminate 36-27 AWG [0.13-0.38 mm] copper magnet wires.

Medium Range and Heavy Range SIAMEZE terminals terminate 23-12 AWG [0.56-2.03 mm] copper magnet wires.

Available with either Moving Beam contacts whereby a single terminal connects to a very wide range of magnet wire sizes, or a Compliant Beam for contacting two magnet wires of the same diameter in one terminal for splicing or bi-filar applications.

According to Tyco Electronics specifications SIAMEZE cavities are either integrated into coil bodies or specially designed cavity housings.

The magnet wires are positioned in the "U" shaped slots.

The SIAMEZE Inserter cuts the terminals from the strip and places the terminals over the magnet wire into the plastic cavities.

During this operation the small stripping devices penetrate the film insulation from the magnet wire.

Residual spring energy in the terminal causes the side walls of the IDC slot to function as opposing cantilever beams.

This constant pressure results in an intimate metal-to-metal interface, providing a reliable, long-term connection.

The wiping action between the wire and terminals remove all oxides or other contaminants present on both the conductor and the terminal slot side walls, producing a clean, stable, gas-tight electrical termination.

The AMP SIAMEZE Inserter may be used as a semi-automatic bench machine or integrated in production lines for fully-automatic applications.

**SIAMEZE Terminals** (Continued)

**Typical Plastic Cavity — Pockets**

**Note:** SIAMEZE typical plastic cavities are not for design; Tyco Electronics will supply required dimensions of cavity for each customer application.

Plastic cavities, designed to Tyco Electronics specifications, may be molded as part of the coil bobbin or attached to a lamination stack in the area of the magnet wire coil.

Each cavity is a rectangular box with two narrow slots on opposing walls and a plastic cutoff or tie-off post.

During or after the winding process, the magnet wire is placed across the plastic cavities and into the slots, either manually or by coil winding equipment.

Unraveling is prevented by a slight friction fit, suitable bend or by wrapping the magnet wire around the tie-off post.

During insertion, the insulation displacing terminal slot strip the film insulation from the magnet wire producing a stable electrical termination.

Terminal retention is retained in the plastic cavities by single or multiple locking barb or multiple locking latches for large quick

disconnect FASTON tab terminals.

Excess magnet wire is trimmed flush with the outside of the plastic cavity by a shear blade traveling with the terminal insertion ram.

**Tyco Electronics can provide design and mold engineering resources to manufacture most specifically designed SIAMEZE cavity housings.**

SIAMEZE Terminals

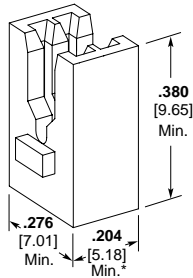

Cavity Part Number 1601421

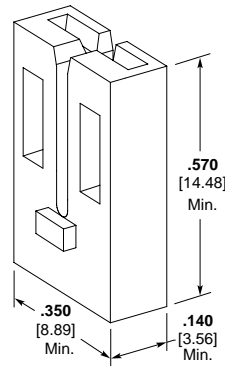

Cavity Part Number 1601423

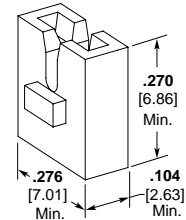

Cavity Part Number 1601424



Cavity Part Number 1601425

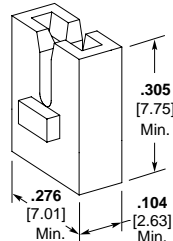

Cavity Part Number 1601427



Cavity Part Number 1601431

\* Minimum dimension with Lead Lok slot.

**SIAMEZE Terminals** (Continued)

**Typical Plastic Cavity — Pockets** (Continued)



**Cavity Part Number 1601432**



**Cavity Part Number 1601433**



**Cavity Part Number 1601434**



**Cavity Part Number 1601435**

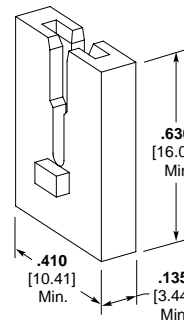

**Cavity Part Number 1601436**

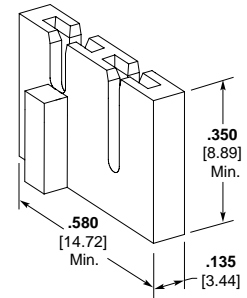

**Cavity Part Number 1601437**

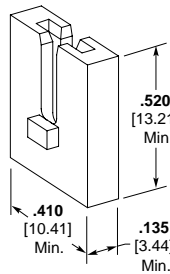

**Cavity Part Number 1601438**

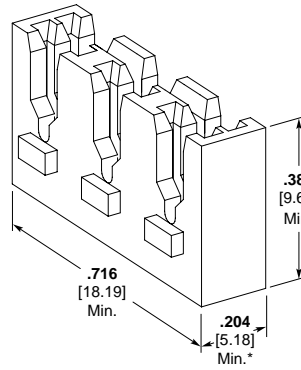

**Cavity Part Number 1601440**

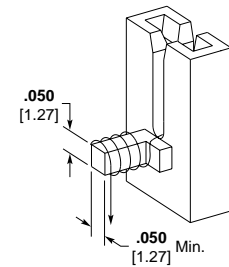

**Wrap Post Part Number 1601447**



**Cavity Part Number 1601462**

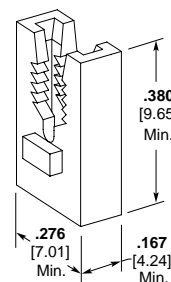

**Cavity Part Number 1601463**

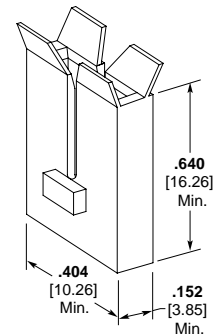

**Cavity Part Number 1601470**

\* Minimum dimension with Lead Lok slot.

**SIAMEZE Terminals** (Continued)

**SIAMEZE Interconnection System**

**How the System Operates**

- ① **Trim Blade**  
The trim blade cuts the excess magnet wire and the wire cutoff block at the front of the cavity.
- ② **Terminal Insertion Finger**  
The terminal insertion finger is part of the SIAMEZE Inserter. It pushes the terminal that was sheared from the carrier strip through the "tube" into the cavity.
- ③ **Contact**  
Various wire attachments in standard, fine, medium and heavy duty terminals are available (See tables).
- ④ **IDC Slot**  
The IDC slot in the terminal will terminate a wide range of magnet wire sizes.
- ⑤ **Stripping Burrs**  
During the insertion process, these burrs strip the film insulation from the magnet wire.
- ⑥ **Locking Barbs**  
Terminal retention is provided in the cavity by single or multiple locking barbs.

- ⑦ **Plastic Cavity**  
Production has to be in accordance with Tyco Electronics specifications (for cavity drawing numbers see tables). **Consulting Tyco Electronics is required for design in.**
- ⑧ **Cavity Slot for Wire**  
The width has to be in accordance with the wire size (see cavity drawings).
- ⑨ **Magnet Wire**  
The magnet wire is positioned in "U" slot manually or automatically by coil winding equipment.
- ⑩ **Wire Cutoff Block**  
The wire cutoff block supports the magnet wire during the trimming process. The magnet wire is cut plain to the cavity front side.
- ⑪ **Terminal Insertion Complete**  
The magnet wire termination is complete when the terminal is fully seated in the cavity.



**Test Results**

Standard Range SIAMEZE products have been submitted to the following tests without significant millivolt increase:

**Current Cycling** —  
50 cycles with each cycle consisting of 15 minutes "ON" followed by 15 minutes "OFF"

**Thermal Shock** —  
10 cycles with each cycle consisting of 30 minutes at 150°C followed by 30 minutes at 21°C

**Humidity — Temperature Cycling**  
10 cycles between 25°C and 65°C at 80 to 100% RH

**SIAMEZE Terminals** (Continued)

**Wire-to-Wire Terminals**

**Material**

Brass



Type	Recommended Pocket <sup>7</sup>	Copper Magnet Wire Range		Lead Wire Range		Part Number	
		AWG	mm <sup>2</sup>	AWG	mm <sup>2</sup>	Reeled	Loose
A Moving Beam	1601421	27-26	0.36-0.13	18-22 <sup>6</sup>	0.8-0.3	1601117-1	4-1601117-12
	1601462					2-1601117-11	
	1601463	18-34	1.02-0.16	18-22 <sup>6</sup>	0.8-0.3	1601000-1	4-1601000-12
B Wire Specific	1601421	18-34	1.02-0.16	20	0.5	1601056-1	4-1601056-12
						2-1601056-11	
		18-34	1.02-0.16	18	0.8	1601074-1	4-1601074-12
C High Carry	1601433	18-34	1.02-0.16	18-22 <sup>6</sup>	0.8-0.3	1601046-1	4-1601046-12
	1601440					2-1601046-11	6-1601046-13
							8-1601046-14
D High Carry Specific	1601433	27-36	0.36-0.13	20	0.5	1601125-1	4-1601125-12
						2-1601125-11	6-1601125-13
E Medium Range	1601436	12-23	2.06-0.56	16-20	1.3-0.5	1601136-1	4-1601136-12
						2-1601136-11	6-1601136-13

<sup>1</sup> Reversed Reeled—Consult Tyco Electronics drawing for orientation.

<sup>2</sup> Loose Single.

<sup>3</sup> Loose Bussed Pair.

<sup>4</sup> Loose Bussed Triple.

<sup>5</sup> Finish is Post Plated Tin over Copper (Consult Tyco Electronics drawing for specifics).

<sup>6</sup> Lead wire may be stranded, solid or bonded with 105°C PVC insulation. Contact Tyco Electronics Engineering when using other types of insulation.

<sup>7</sup> Magnet wire 30 AWG [0.25 mm] and smaller also requires a wrap post per drawing 1601447.



**SIAMEZE Terminals** (Continued)

**Lead Lok Terminals  
Product Facts**

- Provides perpendicular and parallel lead wire strain relief retention forces in excess of 20 lbs.
- AMP Inserter automatically positions and secures lead wire during insertion
- Manual, semi-automated, fully automated systems allow for lead wire termination
- Accepts #18 -#22 [0.3 mm<sup>2</sup>-0.8 mm<sup>2</sup>] AWG solid or stranded lead wire with .115 [2.92] max. insulation diameter
- No lead wire stripping required



SIAMEZE Terminals

Tyco Electronics features the AMP Lead Lok strain relief terminal system that provides optimum lead wire retention when used in conjunction with SIAMEZE insulation displacement terminals.

After the one-step insertion of AMP SIAMEZE wire-to-wire terminals into Tyco Electronics specified plastic cavities, the application is ready for the secondary lead wire attachment.

The lead wire is manually positioned over the magnet wire terminated SIAMEZE wire-to-wire terminal.

The AMP Lead Lok Inserter cuts the Lead Lok terminals from the strip and places the terminal over the lead wire in the plastic cavities.

During this operation, the lead wire is automatically seated, the insulation pierced and the exposed solid or stranded conductor is terminated in the IDC slot of the SIAMEZE wire-to-wire terminal.

Residual spring energy in the terminal causes the side walls of the IDC slot to function as opposing cantilever beams.

This constant pressure results in an intimate metal-to-metal interface, providing a reliable, long-term connection.

Perpendicular and parallel lead wire strain relief retention forces in excess of 20 lbs are achieved.

The AMP Lead Lok Inserter may be a secondary station in the AMP SIAMEZE Wire-to-Wire semi-automatic bench machine or a separate semi-automatic bench machine inserter depending on the application and required production rates.

**SIAMEZE Terminals** (Continued)

**Lead Lok  
Interconnection System**

**How the System Operates**



Type	Recommended Pocket	Lead Wire Range		Part Number	
		AWG	mm <sup>2</sup>	Reeled	Loose
A Lead Lok	1601421 1601433 1601440	18-22 <sup>2</sup>	0.8-0.3	1601140-1 2-1601140-1 <sup>1</sup>	4-1601140-1

<sup>1</sup> Reverse Reeled—Consult Tyco Electronics drawing for orientation.  
<sup>2</sup> Lead wire may be stranded, solid or bonded with 105°C PVC insulation.  
 Contact Tyco Electronics Engineering when using other types of insulation.

**① Lead Lok Insertion Finger**

The Lead Lok insertion finger pushes the Lead Lok that was sheared from the carrier strip and positions the Lead Lok and lead wire into the IDC slot.



**② Lead Lok Terminal**

The Lead Lok terminal provides maximum lead wire retention in the cavity.

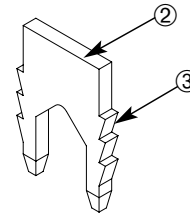

**③ Locking Barbs**

The Lead Lok multiple locking barbs provide retention in the cavity.



**④ Lead Wire**

Stranded, solid and bonded lead wire with 105°C PVC insulation can be used. Contact Tyco Electronics Engineering for other lead wires and insulation under consideration.

**⑤ IDC Slot**

The IDC slot will pierce the lead wire during insertion.

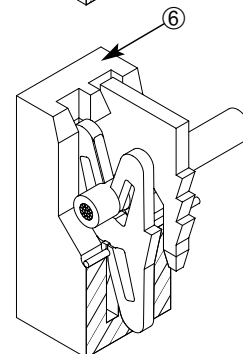

**⑥ Lead Wire Insertion Complete**

The lead wire termination is complete when the Lead Lok is fully seated in the cavity.

**SIAMEZE Terminals** (Continued)

**Posted Terminals**

**Material**

Brass



Type	Recommended Pocket <sup>7</sup>	Copper Magnet Wire Range		L Dim.	Tab Size	Part Number	
		AWG	mm <sup>2</sup>			Reeled	Loose
A PC Tab	1601424	27-36	0.36-0.13	.345 8.76	.040 x .020 1.02 x 0.51	1601120-2 <sup>3</sup> 2-1601120-21.3	4-1601120-2 <sup>3</sup>
		18-34	1.02-0.16	.345 8.76	.040 x .020 1.02 x 0.51	1601009-2 <sup>2</sup> 2-1601009-21.2	4-1601009-2 <sup>2</sup>
		16-17 <sup>6</sup>	1.27-1.15	.345 8.76	.040 x .020 1.02 x 0.51	1601147-2 <sup>3</sup> 2-1601147-21.3	4-1601147-2 <sup>3</sup>
		29 <sup>6</sup>	0.29	.345 8.76	.040 x .020 1.02 x 0.51	1601155-2 <sup>2</sup> 2-1601155-21.2	4-1601155-2 <sup>2</sup>
B Extended PC Tab	1601425	27-36	0.36-0.13	.485 12.32	.040 x .020 1.02 x 0.51	1601128-2 <sup>3</sup> 2-1601128-21.3	4-1601128-2 <sup>3</sup>
		18-34	1.02-0.16	.485 12.32	.040 x .020 1.02 x 0.51	1601041-2 <sup>2</sup> 2-1601041-21.2	4-1601041-2 <sup>2</sup>
				.456 11.57	.040 x .020 1.02 x 0.51	1601095-2 <sup>4</sup> 2-1601095-21.4	4-1601095-2 <sup>4</sup>
				.754 19.16	.047 x .032 1.20 x 0.81	1601110-2 <sup>4</sup> 2-1601110-21.4	4-1601110-2 <sup>4</sup>
C Long Narrow Width Blade	1601431	18-34	1.02-0.16	.669 17.00	.059 x .032 1.50 x 0.81	1601099-1 2-1601099-11	4-1601099-1
				.756 19.21	.059 x .032 1.50 x 0.81	1601063-2 <sup>5</sup> 2-1601063-21.5	4-1601063-2 <sup>5</sup>
				.904 22.96	.059 x .032 1.50 x 0.81	1601037-2 <sup>5</sup> 2-1601037-21.5	4-1601037-2 <sup>5</sup>
				1.005 25.53	.059 x .032 1.50 x 0.81	1601066-2 <sup>4</sup> 2-1601066-21.4	4-1601066-2 <sup>4</sup>
D Tab Pair with Diode Slot	1601425	27-36	0.36-0.13	.710 18.03	.059 x .032 1.50 x 0.81	1601121-2 <sup>4</sup> 2-1601121-21.4	—
		18-34	1.02-0.16	.710 18.03	.059 x .032 1.50 x 0.81	1601065-2 <sup>4</sup> 2-1601065-21.4	—
E Long Medium Width Blade	1601425	18-34	1.02-0.16	.837 21.26	.118 x .025 3.00 x 0.51	1601008-2 <sup>4</sup> 2-1601008-2 <sup>4</sup>	4-1601008-2 <sup>4</sup>
				.837 21.26	.118 x .032 3.00 x 0.81	1601051-2 <sup>4</sup> 2-1601051-21.4	4-1601051-2 <sup>4</sup>
F Long Medium Blade Medium Range	1601438	12-23	0.56-2.06	.872 22.15	.130 x .032 3.30 x 0.81	1601138-1 2-1601138-11	4-1601138-1

<sup>1</sup> Reverse Reeled—Consult Tyco Electronics drawing for orientation.

<sup>3</sup> Finish is Post Plated Tin over Nickel (Consult Tyco Electronics drawing for specifics).

<sup>5</sup> Finish is Pre-Plated Tin (Consult Tyco Electronics drawing for specifics).

<sup>7</sup> Magnet wire 30 AWG [0.25 mm] and smaller also requires a wrap post per drawing 1601447.

<sup>2</sup> Finish is Post Plated Tin over Copper (Consult Tyco Electronics drawing for specifics).

<sup>4</sup> Finish is Pre-Plated Tin over Copper (Consult Tyco Electronics drawing for specifics).

<sup>6</sup> Two magnet wires may be terminated in the same slot if diameters are equal.

Dimensions are in inches and millimeters unless otherwise specified. Values in brackets are metric equivalents.

Dimensions are shown for reference purposes only. Specifications subject to change.

Technical Support  
USA: 1-800-522-6752  
Canada: 1-905-475-6222  
Mexico: 01-800-733-8926

www.tycoelectronics.com

**SIAMEZE Terminals** (Continued)

**110 Series  
FASTON Tab Terminals**

**Material**

Brass

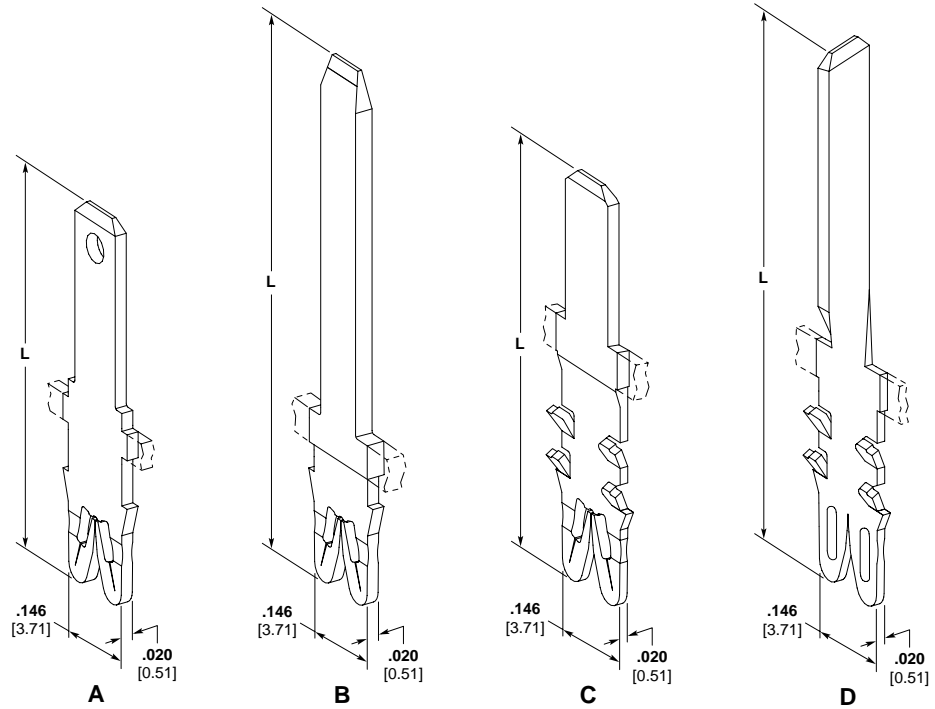

Type	Recommended Pocket <sup>7</sup>	Copper Magnet Wire Range		L Dim.	Tab Feature	Tab Size	Part Number	
		AWG	mm				Reeled	Loose
A Single Barb	1601425	27-36	0.36-0.13	.640 16.26	Hole	.110 x .020 2.79 x 0.51	1601116-1	4-1601116-1
							2-1601116-11	
		18-34	1.02-0.16	.640 16.26	—	.110 x .020 2.79 x 0.51	1601005-1	4-1601005-1
							2-1601005-11	
							1601005-2 <sup>3</sup>	4-1601005-2 <sup>3</sup>
							2-1601005-21,3	
					1601085-1 <sup>3</sup>	4-1601085-1 <sup>3</sup>		
					2-1601085-11,3			
		18-34	1.02-0.16	.846 21.49	Hole	.110 x .020 2.79 x 0.51	1601045-1	4-1601045-1
							2-1601045-11	
					—	.110 x .020 2.79 x 0.51	1601059-1	4-1601059-1
						2-1601059-11		
						1601059-2 <sup>4</sup>	4-1601059-2 <sup>4</sup>	
						2-1601059-21,4		
		18-34	1.02-0.16	.925 23.50	Hole	.110 x .020 2.79 x 0.51	1601073-1	4-1601073-1
						2-1601073-11		
B Single Barb Low Transition	1601431	18-34	1.02-0.16	.945 24.00	—	.110 x .032 2.79 x 0.81	1601097-2 <sup>3</sup>	4-1601097-2 <sup>3</sup>
							2-1601097-21,3	
		27-36	0.36-0.13	1.240 31.50	—	.110 x .032 2.79 x 0.81	1601133-22,5	4-1601133-22
						2-1601133-21,2,5		
C Multi-Barb	1601425	18-34	1.02-0.16	.655 16.63	Hole	.110 x .020 2.79 x 0.51	1601039-1	4-1601039-1
							2-1601039-11	
							1601039-2 <sup>3</sup>	4-1601039-2 <sup>3</sup>
							2-1601039-21,3	
		18-34	1.02-0.16	.630 15.99	—	.110 x .032 2.79 x 0.81	1601064-1	4-1601064-1
						2-1601064-11		
		18-34	1.02-0.16	1.240 31.50	—	.110 x .032 2.79 x 0.81	1601112-22,5	4-1601112-22
						2-1601112-21,2,5		
D Multi-Barb w/ 90° Twist	1601425	21-24 <sup>6</sup>	.51-.72	.915 23.24	—	.110 x .020 2.79 x 0.51	1601151-2 <sup>3</sup>	4-1601151-2 <sup>3</sup>
						2-1601151-21,3		

1 Reversed Reeled—Consult Tyco Electronics drawing for orientation.  
 2 Finish is Pre-Plated Tin over Copper (Consult Tyco Electronics drawing for specifics).  
 3 Finish is Pre-Plated Tin (Consult Tyco Electronics drawing for specifics).  
 4 Finish is Pre-Plated Silver over Nickel (Consult Tyco Electronics drawing for specifics).  
 5 Dual Carrier Strip.  
 6 Two magnet wires may be terminated in the same slot if diameters are equal.  
 7 Magnet wire 30 AWG [0.25 mm] and smaller also requires a wrap post per drawing 1601447.

**SIAMEZE Terminals** (Continued)

**187 Series  
FASTON Tab Terminals**

**Material**

Brass



Type	Recommended Pocket <sup>6</sup>	Copper Magnet Wire Range		L Dim.	Tab Feature	Tab Size	Part Number	
		AWG	mm				Reeled	Loose
A Single Barb	1601425	18-34	1.02-0.16	.605	Hole	.187 x .020 4.75 x 0.51	1601006-2 <sup>3</sup>	4-1601006-2 <sup>3</sup>
				15.37			2-1601006-21,3	
B Single Barb Short Pocket	1601427	18-34	1.02-0.16	.505	—	.187 x .020 4.75 x 0.51	1601011-1	4-1601011-1
				12.83			2-1601011-11	
				.590			1601018-22,5	4-1601018-22
				14.99			2-1601018-21,2,5	
				.985			1601033-22,5	4-1601033-22
C Multi-Barb	1601425	18-34	1.02-0.16	25.02	—	.187 x .020 4.75 x 0.51	2-1601033-21,2,5	4-1601033-22
				.618			1601021-22	4-1601021-22
				15.70			2-1601021-21,2	
				.655			1601013-1	4-1601013-1
				16.64			2-1601013-11	
				.791			1601072-22	4-1601072-22
				20.09			2-1601072-21,2	
				.832			1601068-22	4-1601068-22
				21.14			2-1601068-21,2	
				.655			1601035-1	4-1601035-1
D Multi-Barb Short Profile	1601434	18-34	1.02-0.16	16.64	Hole	.187 x .032 4.75 x 0.81	2-1601035-11	4-1601035-1
				.745			1601035-2 <sup>3</sup>	4-1601035-2 <sup>3</sup>
				18.92			2-1601035-21,3	
				.655			1601040-1	4-1601040-1
				16.64			2-1601040-11	
				.775			1601142-1	4-1601142-1
				19.68			2-1601142-11	
				.492			1601058-22,4	4-1601058-22,4
				12.50			2-1601058-21,2,4	
				.655			1601020-1	4-1601020-1
E Multi-Barb .187/.250 Profile	1601425	18-34	1.02-0.16	16.64	Hole	.187 x .020 4.75 x 0.51	2-1601020-11	4-1601020-1
				.805			1601020-2 <sup>3</sup>	4-1601020-2 <sup>3</sup>
				20.45			2-1601020-21,3	
F Latch	1601423	18-34	1.02-0.16	.775	Hole	.187 x .020 4.75 x 0.51	1601004-1	4-1601004-1
				19.68			2-1601004-11	

1 Reverse Reeled—Consult Tyco Electronics drawing for orientation.  
 2 Finish is Pre-Plated Tin over Copper (Consult Tyco Electronics drawing for specifics).  
 3 Finish is Pre-Plated Tin (Consult Tyco Electronics drawing for specifics).  
 4 Extra Short Tab-Does not meet UL & NEMA length requirements.  
 5 Carrier strip not in retention barb area as shown.  
 6 Magnet wire 30 AWG [0.25 mm] and smaller also requires a wrap post per drawing 1601447.

Dimensions are in inches and millimeters unless otherwise specified. Values in brackets are metric equivalents.

Dimensions are shown for reference purposes only. Specifications subject to change.

Technical Support  
 USA: 1-800-522-6752  
 Canada: 1-905-475-6222  
 Mexico: 01-800-733-8926

www.tycoelectronics.com

**SIAMEZE Terminals** (Continued)

**250 Series  
FASTON Tab Terminals**

**Material**

Brass

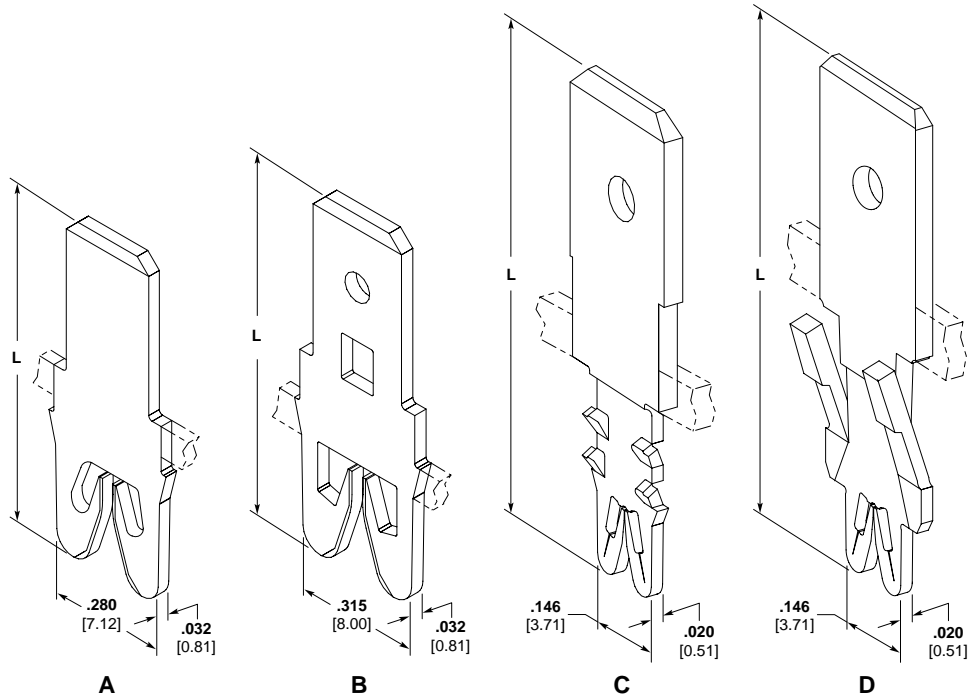

Type	Recommended Pocket <sup>6</sup>	Copper Magnet Wire Range		L Dim.	Tab Feature	Tab Size	Part Number	
		AWG	mm				Reeled	Loose
A Single Barb Medium Range	1601438	12-23	2.03-0.56	.778 19.76	—	.250 x .032 6.35 x 0.81	1601139-2 <sup>3</sup> 2-1601139-21,3	4-1601139-2 <sup>3</sup>
		12-20	2.03-0.8	.885 22.48	Hole	.250 x .032 6.35 x 0.81	1601115-1 2-1601115-11	4-1601115-1
B Single Barb Heavy Range	1601435	16-17 <sup>5</sup>	1.27-1.15	.885 22.48	Hole	.250 x .032 6.35 x 0.81	1601159-1 2-1601159-11	4-1601159-1
		14-15 <sup>5</sup>	1.60-1.40	.885 22.48	Hole	.250 x .032 6.35 x 0.81	1601161-1 2-1601161-11	4-1601161-1
		27-36	0.36-0.13	.745 18.92	Hole	.250 x .032 6.35 x 0.81	1601118-2 <sup>3</sup> 2-1601118-21,3	4-1601118-2 <sup>3</sup>
				.745 18.92	Hole	.250 x .032 6.35 x 0.81	1601002-2 <sup>3</sup> 2-1601002-21,3	4-1601002-2 <sup>3</sup>
C Multi-Barb	1601425	18-34	1.02-0.16	.805 20.45	Hole	.250 x .032 6.35 x 0.81	1601028-2 <sup>3</sup> 2-1601028-21,3	4-1601028-2 <sup>3</sup>
					Dimple	.250 x .032 6.35 x 0.81	1601028-1 2-1601028-11	4-1601028-1
				1.000 25.4	Hole	.250 x .032 6.35 x 0.81	1601061-2 <sup>3</sup> 2-1601061-21,3	4-1601061-2 <sup>3</sup>
				1.281 32.53	Hole	.250 x .032 6.35 x 0.81	1601044-1 2-1601044-11	4-1601044-1
D Latch	1601423	18-34	1.02-0.16	.850 21.59	Hole	.250 x .032 6.35 x 0.81	1601003-1 2-1601003-11	4-1601003-1 <sup>2</sup>

1 Reverse Reeled—Consult Tyco Electronics drawing for orientation.  
 2 Finish is Pre-Plated Tin over Copper (Consult Tyco Electronics drawing for specifics).  
 3 Finish is Pre-Plated Tin (Consult Tyco Electronics drawing for specifics).  
 4 Double Carrier Strip.  
 5 Two magnet wires may be terminated in the same slot if diameters are equal.  
 6 Magnet wire 30 AWG [0.25 mm] and smaller also requires a wrap post per drawing 1601447.

**SIAMEZE Terminals** (Continued)

**Pin Terminals**



Type	Recommended Pocket <sup>5</sup>	Copper Magnet Wire Range		L Dim.	Pin Dia.	Part Number	
		AWG	mm <sup>2</sup>			Reeled	Loose
A Round Pin	1601424	18-34	1.02-0.16	.718 18.24	.084 2.13	1601077-1 2-1601077-11	4-1601077-1
B Pseudo Round Pin with Diode Slot	1601432	27-36	0.36-0.13	.855 21.71	.039 1.00	1601130-22.3 2-1601131-22.3,4	—

- 1 Reverse Reeled—Consult Tyco Electronics drawing for orientation.
- 2 Finish is Pre-Plated Tin over Copper (Consult Tyco Electronics drawing for specifics).
- 3 Diameter is approximate as Pin is not perfectly round.
- 4 Reverse Reeled Mirror Image—Consult Tyco Electronics drawing for orientation.
- 5 Magnet wire 30 AWG [0.25 mm] and smaller also requires a wrap post per drawing 1601447.

**Receptacle Terminals**

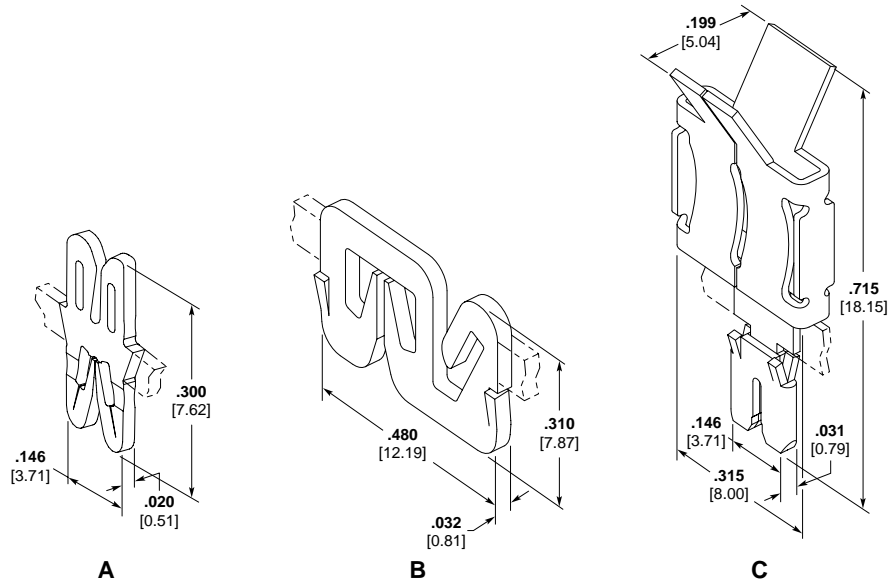

Type	Recommended Pocket <sup>3</sup>	Copper Magnet Wire Range		L Dim.	Mating Tab Size	Part Number	
		AWG	mm <sup>2</sup>			Reeled	Loose
A Edge Contact In Line	1601425	18-34	1.02-0.16	.300 7.62	.020 0.51	1601075-22 2-1601075-21.2	4-1601075-2 <sup>2</sup>
B Edge Contact Off Line	1601421	15-23	1.47-0.56	.310 7.87	.032 0.81	1601137-22 2-1601137-21.2	4-1601137-2 <sup>2</sup>
C Blind Mate Full Surround	1601470	21.5	0.71	.715 18.15	.250 x .020 6.35 x 0.51	1601149-22 2-1601149-21.2	4-1601149-2 <sup>2</sup>

- 1 Reverse Reeled—Consult Tyco Electronics drawing for orientation.
- 2 Finish is Pre-Plated Tin over Copper (Consult Tyco Electronics drawing for specifics).
- 3 Magnet wire 30 AWG [0.25 mm] and smaller also requires a wrap post per drawing 1601447.

## MAG-MATE and SIAMEZE Application Tooling

### MAG-MATE Product Terminator (MPT)

#### Product Facts

- Single, dual and triple insertion
- Two-reel, two-product capability, with alternating feed capability
- Available as horizontal bench, vertical bench or independent module
- Module easily integrates into production lines using simple handshake signals
- Fine adjustment mechanism for insertion depth (.001 increments)
- Tube-type insertion tooling for standard MAG-MATE terminals
- Microprocessor controlled operation
- Holding fixture for bobbin can be designed and built by Tyco Electronics or the customer



For quick, easy and reliable termination of magnet wire without pre-stripping the insulation or soldering, Tyco Electronics offers the MAG-MATE product family and the MPT-5 (MAG-MATE Product Terminator ) air-operated insertion machine with micro-processor control. The MPT-5 machine inserts a MAG-MATE terminal into a customer-designed cavity in the coil bobbin or similar magnet-wire housing, terminating the wire and providing an I/O terminal or other connection. The MAG-MATE system can create a termination that is very close to the coil.

Dual reel capability of the MPT-5 allows insertion of two different MAG-MATE terminals, with the capability to alternate between inserting one and two terminals at a time. Two terminations per second are possible with dual insertion. Loaded with two different terminals, a single MPT-5 can cover a range of 8 AWGs.

A fifth generation machine, the MPT-5 is lighter and quieter than previous versions. The MPT-5 is available as a horizontal or vertical bench machine or as a discrete module for integration into automated lines. The discrete module also can be used to make a custom horizontal or vertical

bench machine. A fixture to hold the coil assembly, which is required for bench operation, can be designed and built by Tyco Electronics or the customer.

The MPT-5 uses three or four air cylinders to feed terminals from one or both reels, cut terminals from the carrier strip, and insert terminals into the cavities. The display shows the operating conditions of the machine such as the batch count, total count, error messages, and ready state. The display also lets the operator step through the machine sequence or manually cycles the machine for set up or easy diagnosis of problems.

### Solderless MAG-MATE Terminations:

- No need to pre-strip the magnet wire
- No wire embrittlements due to solder
- No soldering fumes
- Compact, clean termination
- Ideal for automation
- Fast magnet wire connections: Up to two per second with dual insertion





## MAG-MATE and SIAMEZE Application Tooling (Continued)

### MPT-5S/L Machine for Mag Wire Coil Termination utilizing SIAMEZE and Lead Lok terminals

#### Product Facts

- Single, dual and triple insertion
- Two-reel, two-product capability, with alternating feed capability
- Available as horizontal bench, vertical bench or independent module
- Module easily integrates into production lines using simple handshake signals
- Fine adjustment mechanism for insertion depth (.001 increments)
- Tube-type insertion tooling for standard SIAMEZE & Lead Lok terminals
- Microprocessor controlled operation
- Holding fixture for bobbin can be designed and built by Tyco Electronics or the customer

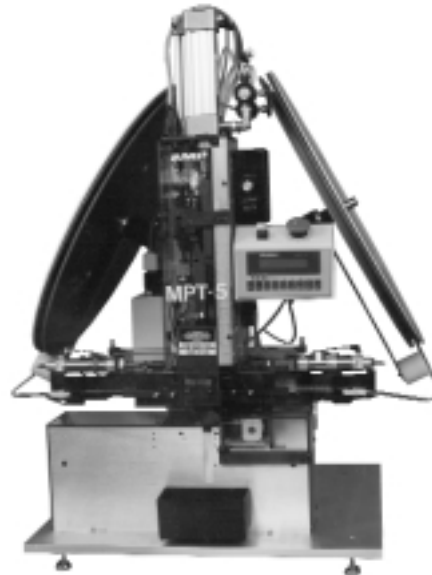

For quick, easy and reliable termination of magnet wire without pre-stripping the insulation or soldering, Tyco Electronics offers the SIAMEZE terminals and Lead Lok product family and the MPT-5S/L (MAG-MATE Product Terminator) air-operated insertion machine with micro-processor control. The MPT-5S/L machine inserts a SIAMEZE terminal into a customer-designed cavity in the coil bobbin or similar magnet-wire housing, terminating the wire and providing an I/O terminal or other connection. The MPT-5S/L can insert both the SIAMEZE terminal for magnet wire termination and the Lead Lok terminal to assure your lead wire connection.

Dual reel capability of the MPT-5S/L allows insertion of two different SIAMEZE

terminals, with the capability to alternate between inserting one and two terminals at a time. Two terminations per second are possible with dual insertion.

A fifth generation machine, the MPT-5s/L is lighter and quieter than previous versions. The MPT-5S/L is available as a horizontal or vertical bench machine or as a discrete module for integration into automated lines. The discrete module also can be used to make a custom horizontal or vertical bench machine. A fixture to hold the coil assembly, which is required for bench operation, can be designed and built by Tyco Electronics or the customer.

The MPT-5S/L uses three or four air cylinders to feed terminals from one or both reels, cut terminals from the carrier strip, and insert

terminals into the cavities. The display shows the operating conditions of the machine such as the batch count, total count, error messages, and ready state. The display also lets the operator step through the machine sequence or manually cycles the machine for set up or easy diagnosis of problems.

Solderless SIAMEZE terminations:

- No need to pre-strip the magnet wire
- No wire embrittlements due to solder
- No soldering fumes
- Compact, clean termination
- Ideal for automation
- Fast magnet and lead wire connections: Up to two per second with dual insertion

**MAG-MATE and SIAMEZE Application Tooling** (Continued)**Application Tooling for  
MAG-MATE Terminals****The Module**

The MPT-5 insertion module is the cornerstone of Tyco Electronics magnet wire application tooling. A fifth generation machine, the MPT-5 module is used in conjunction with our bench machine, LPT-522, Rotary Index Table, and can also be order separately when using your equipment manufacture of choice. Electric, pneumatic and de-reeling controls are available allowing for easy integration in your production line. Experienced Tyco Electronics personnel will work with the customer and the equipment manufacturer to adapt the module to their automated assembly system.

**Specifications**

**Electrical**—120 VAC, 60 Hz, 5 A, 1 Ø, or 240 VAC, 50 Hz, 2 A, 1 Ø

**Air**—80 psi [5.52 bar], 3 scfm [0.00142 m<sup>3</sup>/s]

**Weight**—Approx. 60 lb [27.2 kg]

**Width**—8 [204]

**Depth**—7 [178]

**Height**—30 [762]

**Hand Tools**

Part Number 274250-2  
Poke-In Terminals

Part Number 274260-1  
.187 [4.75] Tab Terminals

Part Number 274282-1  
.250 [6.35] Tab Terminals



This insertion tool is capable of applying terminals furnished as loose piece parts. Use for prototype, production start-up and moderate volume production runs. Terminals can be inserted at rates up to 300 per hour.

**MAG-MATE and SIAMEZE Application Tooling** (Continued)

**Application Tooling for  
MAG-MATE Terminals**

**Rotary Index Table**

**Product Facts**

- High-volume rates, up to 600 assemblies per hour
- Handles Standard and Mini MAG-MATE terminals through interchangeable insertion modules
- Load-while-run feature increases productivity
- Fast, simple machine setup and changeover
- Versions to handle in-line, radial, and linear/angularly opposed cavities
- Easy programming through hand-held keypad/display
- Up to 30 insertion sequences stored in EEPROM memory
- Options include
  - Continuity test station
  - Bend station
  - Dual MAG-MATE modules
  - X- or Y-axis travel
  - Auto-change single/dual insertion modules

The Rotary Index Table is a semiautomatic machine that automatically positions fixtured coils, bobbins, and field assemblies for insertion of MAG-MATE terminals. The table is used with MPT-5 insertion modules, which mount vertically above the table and insert terminals fed from a reel. Modules which are not included as part of the base machine, are available for the entire MAG-MATE line, including Standard and Mini MAG-MATE, SIAMEZE and Lead Lok products.

In operation, the operator places the coil/bobbin/field assembly on the worktable and cycles the machine. The table rotates 90° or 180° to position the assembly under the insertion module for processing. As each terminal is inserted, the machine automatically indexes to the next insertion position. While this assembly is being processed, the operator can remove the assembly processed during the previous cycle and load a new coil/bobbin/field assembly. This load-while-run feature helps maximize productivity. Assembly rates of up to 600 coils per hour (at six terminations per coil) are possible with dual insertion.

A hand-held operator's terminal contains a keypad and easy-to-read LCD display to allow quick, easy programming of machine functions, including insertion sequences. Up to 30 programs (insertion sequences) can be stored in the EEPROM internal memory.

The machine is available with any combination of one or two MPT-5 insertion modules that are fixed or indexing, with or without a rotating fixture for axial insertion. One version allows indexing only in the Y axis for processing in-line cavities. The other includes a rotary fixture that allows the coil/bobbin/field assembly to be rotated to process cavities radially or linear/angularly opposed.

Besides its fast production rates, the rotary



table is also designed to enhance productivity through reliability and easy setup. The number of adjustments required for normal operation has been minimized, while the procedure for product changeovers takes only a few minutes. The result is a machine with little downtime.

Options include a continuity test station, a bend station that bends terminals up to 90° after insertion, dual modules that insert two identical or different terminals simultaneously, and X-axis travel.

Cost savings and productivity are enhanced with Tyco Electronics Field Engineering Service, which provides complete setup and installation assistance, operating and maintenance training, and continuing rapid response through the Toll-Free Technical Support Center at 1-800-522-6752.

**MAG-MATE and SIAMEZE  
Application Tooling**

**MAG-MATE and SIAMEZE Application Tooling** (Continued)**LPT-522 Linear Product Terminator****Product Facts**

- Intermediate to high volume rates, up to 600 assemblies per hour
- Flexible platform accommodates secondary application modules
- Version to handle in-line, radial, and linear/angularly opposed cavities
- Programmable linear slide and rotary table
- Easy programming through keypad display
- Palletized fixture system for greater efficiency and production rates
- Microprocessor controlled
- Fine insertion depth adjustment (.001 increments)
- Two-reel, two-product capability with or without alternating feed
- Single, dual separate, and on-the-fly dual common insertion capability

**Specifications**

**Air** — 10 scfm@80 psi minimum

**Electrical** — 110 VAC, 5 AMP

**Footprint** — 60"x 52"

The Linear Product Terminator-522 was designed for intermediate to high volume applications. It is also a very flexible platform since it can accommodate two secondary application modules. These can include, but are not limited to, special wrap-off post trim, continuity testing with defective coil identification, and tab bending.

The LPT-522 features our MPT-5 insertion module as well as a programmable linear slide and rotary table system. The flexible system can process coils that have cavity configurations in a linear pattern, axial pattern, or combination of both.

The LPT-522 machine is of a serial process design, which allows for a unique coil holding fixture. This fixture can be palletized to increase your efficiency and production rates. The palletized system allows the operator to load/unload a pallet of coils while a second pallet is processing on this machine, increasing the machine up time and decreasing non-productive labor.



**MAG-MATE and SIAMEZE Application Tooling** (Continued)

**LPT-522 Linear Product Terminator** (Continued)

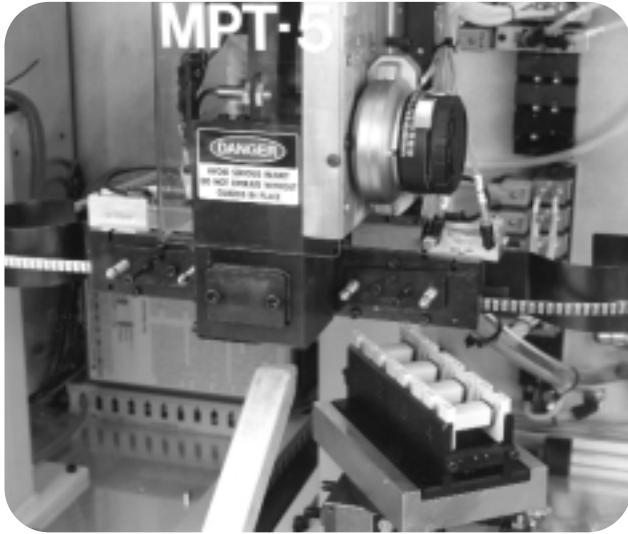

Rotary Index Insertion Process

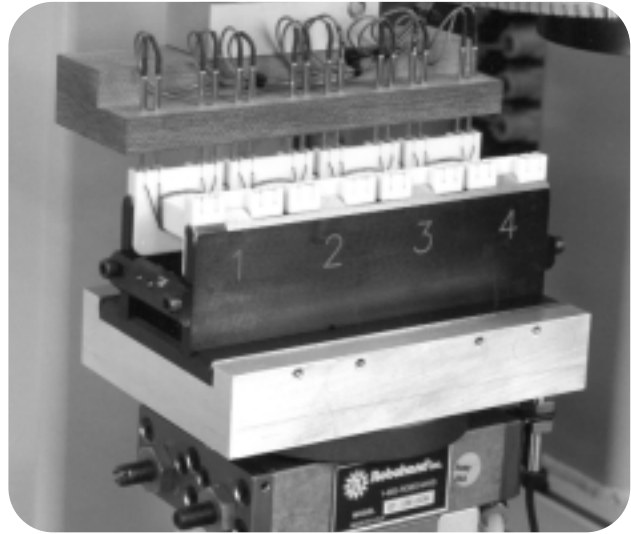

Optional Continuity Test Station

**MAG-MATE and SIAMEZE**  
Application Tooling

**Magnet Wire Termination Machines—Cost Comparison**

Machine Attribute	Horizontal Bench Machine (HBM)	Vertical Bench Machine (VBM)	LPT-522 Insertion Machine	RIT Insertion Machine
Applications	<ul style="list-style-type: none"> <li>● Single row bobbin</li> <li>● Single terminal feed</li> <li>● Bottom trim</li> </ul>	<ul style="list-style-type: none"> <li>● Single/Dual/Axial bobbin</li> <li>● Single or dual feed</li> <li>● Bottom or top trim</li> </ul>	<ul style="list-style-type: none"> <li>● Same as VBM plus:                             <ul style="list-style-type: none"> <li>-Multiple bobbin capacity</li> <li>△Auxiliary stations</li> </ul> </li> <li>● Serial Processing</li> </ul>	<ul style="list-style-type: none"> <li>● Same as LPT, plus:                             <ul style="list-style-type: none"> <li>-Up to 3 different terminals</li> </ul> </li> <li>● Parallel processing</li> </ul>
Machine Cost	■	■■	■■■	■■■■
Fixture Cost	■■	■■■	■	■■■■
Complexity	■	■■	■■■■	■■■■
Production Rate	■	■	■■■	■■■■
Cost / Insertion	■■■	■■■■	■■	■

[■] = lowest level] [■■] = mid level] [■■■] = high level] [■■■■] = highest level]

*Note: All machine options work in conjunction with our MPT-5 module. The MPT-5 module can incorporate an on-the-fly feature, which allows for selection of dual common insertions. The MPT-5 module can also be incorporated in your automated line using your integrator of choice. Please call for details.*

## AMPLIVAR Splices

### Product Facts

- Compression crimp eliminates cold solder points, weld burns and wire embrittlement usually connected with thermal-type terminations
- Excellent tensile strength—vibration resistant
- Provides a superior electrical connection that is free of many contaminants such as stripper residue and solder flux
- Precision formed, strip-fed splices terminated in AMP automatic machines for high production rates per hour
- High termination rates, low wire consumption and the elimination of rejects caused by solder flux or heat damage results in the lowest applied costs
- Precisely controlled crimp termination helps eliminate human error for maximum reliability
- Splice up to 3 magnet wires together with stranded lead in one barrel

### Applications

- Motor windings and connections
- Coil connections
- Transformer windings and connections
- Solid wire connections
- Lighting ballasts
- Power supplies
- Starters and alternators



Tyco Electronics offers a full selection of AMP AMPLIVAR splices that are specifically designed to terminate magnet wire to itself or in combination with standard solid or stranded lead wire.

AMPLIVAR splices have machined, sharp edged serrations inside the crimp barrels. These serrations, made by a special production process, pierce the insulating layer of magnet wires in a manner that provides a large contact area.

In a one-step operation the magnet wire is automatically multiple ring-stripped of its

insulation as it is forced into the serrations during the precisely controlled crimp.

The resulting termination produces a high tensile strength, air-sealed connection that is as resistant to corrosion as the insulated conductor.

As many as three magnet wires can be terminated simultaneously in one splice. In addition, copper or aluminum magnet wire, or a combination of both, can be terminated.

When required, copper or aluminum magnet wire can

be combined with standard, pre-stripped solid or stranded lead wires.

Depending on your specific application, AMPLIVAR splices are available in 5, 7 and 9 serration versions for terminations in the 100 to 22,000 CMA range as well as miniature and subminiature designs for terminations in the 100 to 1850 CMA range.

The crimping of AMPLIVAR splices is done by semi-automatic crimping machines for high output per hour production rates.

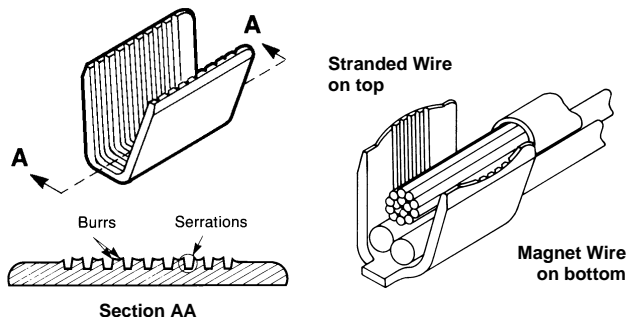

## AMPLIVAR Splices (Continued)

### Technical Features

**Applicable Types of Wire** — Cu, Al (Solid) together or in combination with stranded lead wire

**Wire Size Range** — from 300 to 13,000 CMA (0.1 mm<sup>2</sup> to 6.6 mm<sup>2</sup>)

**Terminal Base Material** — Brass, phosphor bronze

**Surface Finish** — plain and tin plated except where noted

**Temperature Range** — -65°C to +150°C

**Rated Current** — according connected wire size

**Rated Voltage** — according terminated winding

### Test Results

The AMPLIVAR products have been subjected to the following tests without significant millivolt losses.

**Temperature Cycling** — 25 cycles with each cycle consisting of 30 minutes at +125°C followed by 30 minutes at -65°C

**Heat Age** — 96 hours at +150°C

**Thermal Shock** — 25 cycles with each cycle consisting of 30 minutes at +150°C followed by 30 minutes at -65°C

**Salt Spray** — 96 hours at +35°C with a 5% salt solution spray

**Humidity** — 96 hours at 90-95% relative humidity and +40°C

**Current Cycling** — 10,000 cycles with each consisting of 3 minutes on and 3 minutes off at a current (25 A) which establishes a wire temperature

### TYPICAL CURRENT CYCLING TEST RESULTS

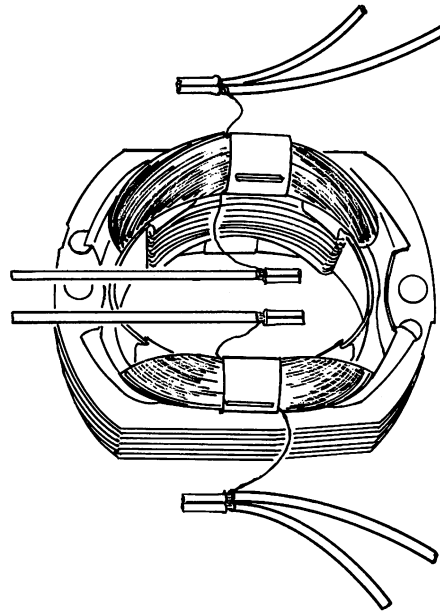

AMPLIVAR Splices

## AMPLIVAR Splices (Continued)

### General Application Guidelines

To assist you in obtaining the optimum AMPLIVAR termination, the following guidelines are recommended:

1. All magnet wires must be placed in the bottom of the wire barrel before crimping. If lead wire is to be crimped in the same termination, it should be placed on top of the magnet wires.
2. Wire barrels are designed to accept a maximum of three insulated magnet wires plus stranded lead wires.
3. The ratio of magnet wire diameters crimped in any wire barrel should not exceed 2:1. This ratio is approximately a range from the largest to the smallest magnet wire of six sizes.
4. The sum of the circular mil area (CMA) of the magnet wires and any lead wires should not exceed the capacity of the splice.
5. The sum of the diameters of the individual magnet wires plus twice the terminal stock thickness must be equal to or less than the crimp width.
6. Magnet wire of 26 AWG [0.40 mm] or smaller should be used with 7-serration splices having "shallow serrations," and magnet wire of 28 AWG [0.32 mm] or smaller should be used with 9-serration splices having "shallow serrations" (part numbers identified with asterisk [\*] are in the tabular data on the following technical pages).
7. Magnet wire of 20 AWG [0.81 mm] or larger having an insulation thickness heavier than "single film coated," should not be used with splices having "shallow serrations" (those part numbers marked with an asterisk [\*] in the tabular data on the following technical pages).
8. When aluminum magnet wire is used, splices and terminals must be tin plated.
9. Consult Tyco Electronics for splice and terminal selection and recommendations for all non-standard applications.

### Technical Documents

**Application Specifications** describe requirements for using the product in its intended application and or crimping information. They are intended for the Packaging and Design Engineer and the Machine Setup Person.

114-2002	AMPLIVAR 7-Serration Pigtail Splices	114-2006	AMPLIVAR Subminiature Pigtail Splices
114-2003	AMPLIVAR 9-Serration Pigtail Splices	114-2009	AMPLIVAR 5-Serration Thru Splices
114-2005	AMPLIVAR Subminiature Thru Splices	114-2016	AMPLIVAR Miniature Pigtail Splices

### Suggested Splice Selection Procedure

Use the following guide to help you to determine the proper splice for your application:

1. Use 9-serration splices, tin plated when terminating aluminum magnet wire or combinations with aluminum magnet wire.
2. Use 9-serration splices for hermetic and severe environment applications.
3. Use splices identified with an asterisk [\*] when terminating 7-serration 26 AWG [0.40 mm] or smaller wires and 9-serration 28 AWG [0.32 mm] or smaller wires.
4. Calculate the total CMA of the magnet wires plus any lead wires to be terminated. Always use the coated magnet wire for CMA (see pages 94-96).
5. Calculate the total magnet wire diameters (see pages 94 and 95).
6. Select a splice for trial calculations. It should have the proper CMA range. Plating finish should be considered at this time.
7. Calculate the sum of the magnet wire diameters plus two splice stock thicknesses. If this total is less than the crimp width of the splice selected, it may be used. If the total is greater than the crimp width, a splice with a greater crimp width must be selected. Consult Tyco Electronics for special wide tooling recommendations.

#### Example:

- Selection of a Pigtail Splice to terminate the following wires:  
One 28 AWG [0.32 mm] copper magnet wire.  
One 22 AWG [0.64 mm] aluminum magnet wire.  
One 18 AWG [0.8-0.9 mm<sup>2</sup>] 19-strand copper lead wire.

■ Calculate the total CMA (Procedure 4):	
28 AWG [0.32 mm] coated magnet wire	= 185 CMA
22 AWG [0.64 mm] coated magnet wire	= 708 CMA
18 AWG [0.8-0.9 mm <sup>2</sup> ] stranded lead wire	= 1608 CMA
<b>Total</b>	<b>= 2501 CMA</b>

■ Calculate the sum of the magnet wire diameters (Procedure 5):	
28 AWG [0.32 mm] coated magnet wire	= .0136 [0.35]
22 AWG [0.64 mm] coated magnet wire	= .0266 [0.68]
<b>Total</b>	<b>= .0402 [1.03]</b>

- Select a terminal for trial calculations. Splice No. 62305-2, page 49 (Procedure 6):  
CMA range = 600-3000  
Stock thickness = .016 [0.41]  
Crimp width = .110 [2.79]  
9-serration, tin plated for aluminum magnet wire (Procedure 1).  
Splice identified with asterisk [\*] for 28 AWG [0.32 mm] (Procedure 3).
- Calculate the sum of the magnet wire diameters plus two splice stock thicknesses (Procedure 7):  
.0402 + (.016 x 2) = .0722  
[1.02 + (0.41 x 2) = 1.84  
.0722 [1.84] is less than the splice crimp width of .110 [2.79]; therefore, Part No. 62305-2 may be used.



**AMPLIVAR Splices** (Continued)

**9 Serrations —  
Pigtail Type**

**Product Facts**  
(Plus All 7 Serration Facts)

- Splice length is increased on larger CMA splices for improved performance
- Serration depths are varied within the splice to give optimum electrical/mechanical performance on all wire sizes
- Serration sidewall angles are varied to allow better wire stripping and serration fill
- Flat bottom of splice helps keep magnet wires on bottom as required during crimping
- Magnet wires 28 AWG [0.32 mm] and larger may be terminated without requiring shallow serrations
- Additional serrations enhance stability of crimp



AWG/ mm <sup>2</sup>	Wire Range Solid Dia.	Wire Range CMA	Stock Thickness	Crimp Width	Dim. L	Material	Part Number
24-18.5 0.26-0.80	<b>.020-.039</b> 0.55-1.00	400-1500	<b>.016</b> 0.41	<b>.080</b> 2.03	<b>.225</b> 5.72	Tin Plated Brass	62303-2*
22-15.5 0.38-1.54	<b>.028-.055</b> 0.70-1.40	600-3000	<b>.020</b> 0.51	<b>.110</b> 2.79	<b>.225</b> 5.72	Tin Plated Brass	62304-2
22-15.5 0.38-1.54	<b>.028-.055</b> 0.70-1.40	600-3000	<b>.016</b> 0.41	<b>.110</b> 2.79	<b>.225</b> 5.72	Tin Plated Brass	62305-2*
18.5-13.5 0.80-2.54	<b>.039-.071</b> 1.00-1.80	1500-5000	<b>.020</b> 0.51	<b>.110</b> 2.79	<b>.225</b> 5.72	Tin Plated Brass	62306-2
18.5-13.5 0.80-2.54	<b>.039-.071</b> 1.00-1.80	1500-5000	<b>.016</b> 0.41	<b>.110</b> 2.79	<b>.225</b> 5.72	Tin Plated Brass	62307-2*
15.5-12 1.54-3.46	<b>.055-.083</b> 1.40-2.10	3000-7000	<b>.020</b> 0.51	<b>.140</b> 3.56	<b>.265</b> 6.73	Tin Plated Brass	62308-2
13.5-10 2.54-4.90	<b>.071-.098</b> 1.80-2.50	5000-10,000	<b>.025</b> 0.64	<b>.180</b> 4.57	<b>.265</b> 6.73	Tin Plated Brass	62309-2
12-9 3.46-6.38	<b>.083-.112</b> 2.10-2.85	7000-13,000	<b>.025</b> 0.64	<b>.180</b> 4.57	<b>.265</b> 6.73	Tin Plated Brass	62310-2
10-6.5 4.90-9.45	<b>.098-.137</b> 2.50-3.47	10,000-22,000	<b>.030</b> 0.76	<b>.220</b> 5.59	<b>.340</b> 8.64	Tin Plated Brass	62311-2 <sup>1</sup>

\*These splices are recommended for applications using wire size 28 AWG [0.32 mm] or smaller.  
<sup>1</sup> Special high force application equipment required.



**7 Serrations —  
Pigtail Type**

**Product Facts**

- Taper on both crimper and anvil improves flex life of termination
- Longer “flat” on tooling improves electrical performance (.125 vs. .080 [3.18 vs. 2.03])
- Radius on wire entry end of splice helps prevent nicking wires and improves mechanical performance
- Serrations are offset to sheared end to place additional serrations in “electrical” portion of crimped splice
- Splice CMA ranges are overlapped so that two splices are available for any given CMA

AWG/ mm <sup>2</sup>	Wire Range Solid Dia.	Wire Range CMA	Stock Thickness	Crimp Width	Dim. L	Material	Part Number
22-15.5 0.38-1.54	<b>.028-.055</b> 0.70-1.40	600-3000	<b>.020</b> 0.51	<b>.110</b> 2.79	<b>.225</b> 5.72	Brass	62000-1
22-15.5 0.38-1.54	<b>.028-.055</b> 0.70-1.40	600-3000	<b>.020</b> 0.51	<b>.110</b> 2.79	<b>.225</b> 5.72	Brass	62157-1*
22-15.5 0.38-1.54	<b>.028-.055</b> 0.70-1.40	600-3000	<b>.020</b> 0.51	<b>.110</b> 2.79	<b>.225</b> 5.72	Tin Plated Brass	62000-2
22-15.5 0.38-1.54	<b>.028-.055</b> 0.70-1.40	600-3000	<b>.020</b> 0.51	<b>.110</b> 2.79	<b>.225</b> 5.72	Tin Plated Brass	62157-2*
22-15.5 0.38-1.54	<b>.028-.055</b> 0.70-1.40	600-3000	<b>.020</b> 0.51	<b>.110</b> 2.79	<b>.225</b> 5.72	Tin Plated Brass	62200-2 <sup>1</sup>
18.5-13.5 0.80-2.54	<b>.039-.071</b> 1.00-1.80	1500-5000	<b>.020</b> 0.51	<b>.110</b> 2.79	<b>.225</b> 5.72	Brass	62040-2
18.5-13.5 0.80-2.54	<b>.039-.071</b> 1.00-1.80	1500-5000	<b>.020</b> 0.51	<b>.110</b> 2.79	<b>.225</b> 5.72	Tin Plated Brass	62040-1
18.5-13.5 0.80-2.54	<b>.039-.071</b> 1.00-1.80	1500-5000	<b>.020</b> 0.51	<b>.110</b> 2.79	<b>.225</b> 5.72	Phosphor Bronze	964156-1
15.5-12 1.54-3.46	<b>.055-.083</b> 1.40-2.10	3000-7000	<b>.020</b> 0.51	<b>.140</b> 3.56	<b>.225</b> 5.72	Brass	62001-1
15.5-12 1.54-3.46	<b>.055-.083</b> 1.40-2.10	3000-7000	<b>.020</b> 0.51	<b>.140</b> 3.56	<b>.225</b> 5.72	Tin Plated Brass	62001-2
15.5-12 1.54-3.46	<b>.055-.083</b> 1.40-2.10	3000-7000	<b>.020</b> 0.51	<b>.140</b> 3.56	<b>.225</b> 5.72	Tin Plated Brass	62201-2 <sup>1</sup>
12-10 2.10-6.0	<b>.085-.110</b> 2.10-2.85	7000-12,000	<b>.025</b> 0.64	<b>.250</b> 6.35	<b>.225</b> 5.72	Tin Plated Brass	62295-1
12-10 2.10-6.0	<b>.085-.110</b> 2.10-2.85	7000-12,000	<b>.025</b> 0.64	<b>.250</b> 6.35	<b>.225</b> 5.72	Brass	62295-2
12-9 2.10-6.38	<b>.085-.115</b> 2.10-3.47	7000-13,000	<b>.025</b> 0.64	<b>.180</b> 4.57	<b>.225</b> 5.72	Tin Plated Brass	62002-2

\*These splices are recommended for applications using wire size 26 AWG [0.40 mm] or smaller.  
<sup>1</sup> Flat bottom.

AMPLIVAR Splices

**AMPLIVAR Splices** (Continued)

**7 Serrations —  
Thru Type**

**Product Facts**

- Crimp bellmouth provides retention in circular cavity slot in bobbin



AWG/ mm <sup>2</sup>	Wire Range Solid Dia.	Wire Range CMA	Stock Thickness	Crimp Width	Dim. L	Material	Part Number
22-15.5 0.38-1.54	<b>.028-.055</b> 0.70-1.40	600-3000	<b>.020</b> 0.51	<b>.110</b> 2.79	<b>.225</b> 5.72	Tin Plated Brass	1217384-1*

\*These splices are recommended for applications using wire size 26 AWG [0.40 mm] or smaller.

**5 Serrations —  
Thru Type**

**Product Facts**

- Wide range of thru splices
- Serrations centered in splice to achieve optimum electrical and mechanical performance in a thru splice
- CMA range accepts a wide variety of wire sizes and combinations



Type	AWG/ mm <sup>2</sup>	Wire Range Solid Dia.	Wire Range CMA	Stock Thickness	Crimp Width	Dim. L	Material	Part Number
A	17-12.5 1.00-2.80	<b>.045-.075</b> 1.15-1.85	2000-5400	<b>.020</b> 0.51	<b>.110</b> 5.08	<b>.235</b> 5.97	Brass	63564-1
	10-8 5.00-8.00	<b>.100-.125</b> 2.55-3.20	10,000-16,000	<b>.032</b> 0.80	<b>.180</b> 4.57	<b>.267</b> 6.78	Tin Plated Brass	63561-1
	10-7.5 5.00-11.50	<b>.100-.150</b> 2.60-3.80	10,400-22,900	<b>.030</b> 0.76	<b>.300</b> 7.62	<b>.310</b> 7.87	Tin Plated Brass	63562-1
B	22-15.5 0.38-1.54	<b>.028-.055</b> 0.70-1.40	600-3000	<b>.020</b> 0.51	<b>.110</b> 2.79	<b>.225</b> 5.72	Brass	42076
	22-15.5 0.38-1.54	<b>.028-.055</b> 0.70-1.40	600-3000	<b>.020</b> 0.51	<b>.110</b> 2.79	<b>.225</b> 5.72	Brass	42192-1*
	22-15.5 0.38-1.54	<b>.028-.055</b> 0.70-1.40	600-3000	<b>.020</b> 0.51	<b>.110</b> 2.79	<b>.225</b> 5.72	Tin Plated Brass	42192-2*
	22-15.5 0.38-1.54	<b>.028-.055</b> 0.70-1.40	600-3000	<b>.020</b> 0.51	<b>.110</b> 2.79	<b>.225</b> 5.72	Brass	42778-1* <sup>1</sup>
	22-15.5 0.38-1.54	<b>.028-.055</b> 0.70-1.40	600-3000	<b>.020</b> 0.51	<b>.110</b> 2.79	<b>.225</b> 5.72	Tin Plated Brass	42778-2* <sup>1</sup>
	18.5-13.5 0.80-2.54	<b>.039-.071</b> 1.00-1.80	1500-5000	<b>.020</b> 0.51	<b>.110</b> 2.79	<b>.225</b> 5.72	Brass	41765
	18.5-13.5 0.80-2.54	<b>.039-.071</b> 1.00-1.80	1500-5000	<b>.020</b> 0.51	<b>.110</b> 2.79	<b>.225</b> 5.72	Tin Plated Brass	41899
	18.5-13.5 0.80-2.54	<b>.039-.071</b> 1.00-1.80	1500-5000	<b>.020</b> 0.51	<b>.110</b> 2.79	<b>.225</b> 5.72	Brass	42119-1*
	18.5-13.5 0.80-2.54	<b>.039-.071</b> 1.00-1.80	1500-5000	<b>.020</b> 0.51	<b>.110</b> 2.79	<b>.225</b> 5.72	Brass	42776-1* <sup>1</sup>
	18.5-13.5 0.80-2.54	<b>.039-.071</b> 1.00-1.80	1500-5000	<b>.020</b> 0.51	<b>.110</b> 2.79	<b>.225</b> 5.72	Tin Plated Brass	42776-2* <sup>1</sup>
	15.5-12 1.54-3.46	<b>.055-.083</b> 1.40-2.10	3000-7000	<b>.020</b> 0.51	<b>.140</b> 3.56	<b>.225</b> 5.72	Brass	41766
	15.5-12 1.54-3.46	<b>.055-.083</b> 1.40-2.10	3000-7000	<b>.020</b> 0.51	<b>.140</b> 3.56	<b>.225</b> 5.72	Tin Plated Brass	41900
	15.5-12 1.54-3.46	<b>.055-.083</b> 1.40-2.10	3000-7000	<b>.020</b> 0.51	<b>.140</b> 3.56	<b>.225</b> 5.72	Brass	42779-11
	15.5-12 1.54-3.46	<b>.055-.083</b> 1.40-2.10	3000-7000	<b>.020</b> 0.51	<b>.140</b> 3.56	<b>.225</b> 5.72	Tin Plated Brass	42779-21
	12-10 3.46-6.00	<b>.083-.110</b> 2.10-2.80	7000-12,000	<b>.025</b> 0.64	<b>.250</b> 6.35	<b>.225</b> 5.72	Tin Plated Brass	61074-11, <sup>2</sup>
	12-9 3.46-6.38	<b>.083-.112</b> 2.10-2.85	7000-13,000	<b>.025</b> 0.64	<b>.180</b> 4.57	<b>.225</b> 5.72	Brass	41770
	12-9 3.46-6.38	<b>.083-.112</b> 2.10-2.85	7000-13,000	<b>.025</b> 0.64	<b>.180</b> 4.57	<b>.225</b> 5.72	Tin Plated Brass	41904
	12-9 3.46-6.38	<b>.083-.112</b> 2.10-2.85	7000-13,000	<b>.025</b> 0.64	<b>.180</b> 4.57	<b>.225</b> 5.72	Brass	42780-11
12-9 3.46-6.38	<b>.083-.112</b> 2.10-2.85	7000-13,000	<b>.025</b> 0.64	<b>.180</b> 4.57	<b>.225</b> 5.72	Tin Plated Brass	42780-21	

\* These splices are recommended for applications using wire size 26 AWG [0.40 mm] or smaller.

<sup>1</sup> Increased terminal pitch.

<sup>2</sup> Increased U-diameter.

## AMPLIVAR Splices (Continued)

### 5 Serrations — Pigtail Type



#### Product Facts

- Serration depths are varied within the splice to give optimum electrical / mechanical performance on all wire sizes
- Flat bottom of splice helps keep magnet wires on bottom as required during crimping

AWG/ mm <sup>2</sup>	Wire Range Solid Dia.	Wire Range CMA	Stock Thickness	Crimp Width	Dim. L	Material	Part Number
20-17 0.50-1.00	.030-.045 0.80-1.15	1000-2000	.016 0.41	.100 2.54	.225 5.72	Tin Plated Brass	62670-2* <sup>1</sup>

\*These splices are recommended for applications using wire size 26 AWG [0.40 mm] or smaller.  
<sup>1</sup> Flat bottom.

### Miniature Splice — Pigtail Type



#### Product Facts

- The Miniature AMPLIVAR splice was developed for crimping thinner copper magnet wires having a diameter between .003 and .016 [0.08 and 0.40 mm] and has to be connected with a stranded conductor
- The diameter of one conductor strand should not exceed the magnet wire diameter to be applied

AWG/ mm <sup>2</sup>	Wire Range Solid Dia.	Wire Range CMA	Stock Thickness	Crimp Width	Dim. L	Material	Part Number
27-21 0.10-0.40	.014-.030 0.35-0.75	200-850	.012 0.30	.055 1.40	.195 4.95	Tin Plated Brass	63431-1
25-18 0.16-0.90	.015-.045 0.45-1.10	300-1850	.012 0.30	.070 1.78	.195 4.95	Copper-Nickel	61166-1
24-18.5 0.20-0.75	.020-.039 0.55-1.00	480-1500	.014 0.36	.080 2.03	.195 4.95	Tin Plated Brass	62341-1
24-18.5 0.20-0.75	.020-.039 0.55-1.00	480-1500	.014 0.36	.080 2.03	.195 4.95	Brass	62341-2
24-18 0.20-0.80	.020-.040 0.55-1.00	480-1700	.016 0.41	.070 1.78	.195 4.95	Brass	62044-1

### Subminiature Splice — Thru or Pigtail Type



#### Product Facts

- The compactness of these splices makes them ideal for use in small subfractional motors, transformers, relays, solenoids, indicator lamps and small appliance terminations
- These splices provide the same reliability as the larger AMPLIVAR splices

AWG/ mm <sup>2</sup>	Wire Range Solid Dia.	Wire Range CMA	Stock Thickness	Crimp Width	Dim. L	Material	Part Number
30-26 0.05-0.15	.010-.015 0.30-0.50	100-300	.010 0.25	.042 1.08	.080 2.03	Tin Plated Brass	63621-2
24-19 0.26-0.60	.020-.035 0.55-0.90	400-1300	.016 0.41	.070 1.78	.100 2.54	Tin Plated Brass	62194-2
24-19 0.26-0.60	.020-.035 0.55-0.90	400-1300	.016 0.41	.070 1.78	.100 2.54	Gold Plated Brass	62194-4

**AMPLIVAR Terminals**

**Products Facts**

- Ring tongue terminals available for 2 to 3/8 stud diameters
- FASTON Tab terminals accept .125 [3.18], .187 [4.75] and .250 [6.35] receptacle terminals
- FASTON Receptacle terminals accept .187 [4.75] and .250 [6.35] tab terminals
- FASTON Stator Receptacle accept .250 x .032 [6.35 x 0.81] tab terminal
- Pin receptacle terminals accept .062 [1.57] and .090 [2.29] diameter pins



**Applications**

- Motor windings
- Transformers
- Power supplies
- Starters and alternators

AMPLIVAR magnet wire terminals are designed to terminate copper and/or aluminum magnet wire.

Terminals are insulation displacing; therefore, magnet wires do not require a separate prestripping operation.

The unique wire barrel design, with serrations and burrs, produces a superior metal-to-metal compression crimp with excellent tensile strength.

Terminals are available in a variety of ring tongue, FASTON straight, flag and stator receptacles and tab quick-disconnect style terminals.

Direct connection to magnet wire eliminates the need for separate stranded wire terminal connection to input/output devices.

Matched with AMP automated application tooling allows high production rates for strip-form terminals.

**Product Specifications** describe the product qualification test results completed by Tyco Electronics for consideration of product use in a specific application. They are intended for the Design and Product Reliability Engineer.

- 108-16000 — AMPLIVAR Ring Tongue Terminals
- 108-1718 — AMPLIVAR .125 Blade Terminals [Type A]

**Technical Documents**

**Application Specifications** describe requirements for using the product in its intended application and or crimping information. They are intended for the Packaging and Design Engineer and the Machine Setup Person.

114-2145	AMPLIVAR .125 Blade Terminals	114-2144	AMPLIVAR FASTON Series .250 Straight Receptacle Terminals	114-2080	AMPLIVAR Pin Receptacle Terminals [Type A]
114-2146	AMPLIVAR FASTIN-FASTON Series 187 Tab Terminals	114-2152	AMPLIVAR Flag FASTON Series 187 & 250 Receptacle Terminal	114-2128	AMPLIVAR Stator Receptacle with FASTON Mating End
114-2070	AMPLIVAR FASTON Series 250 Tab Terminals				

## AMPLIVAR Terminals (Continued)

### Ring Tongue Terminals

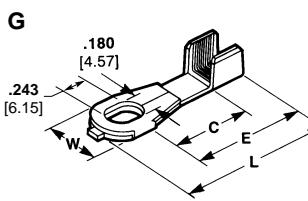

#### Wire Size Range 29–22 AWG [0.287–0.643 mm]

Type	Insulation Dia. Range	Hole Dia.	Stud Size	Stock Thk.	Material	Dimensions				Part Number
						W	L	E	C	
B	.040-.060 1.02-1.52	.197 5	10	.020 0.51	Tin Plated Brass	.342 8.69	.833 21.16	.662 16.81	.312 7.92	63399-1

#### Wire Size Range 23–19 AWG [0.574–0.912 mm]

Type	Insulation Dia. Range	Hole Dia.	Stud Size	Stock Thk.	Material	Dimensions				Part Number
						W	L	E	C	
B	.100-.140 2.54-3.56	.171 4.34	8	.020 0.51	Tin Plated Brass	.342 8.69	.833 21.16	.662 16.81	.312 7.92	60321-2
A	.125-.165 3.18-4.19	.171 4.34	8	.020 0.51	Tin Plated Brass	.300 7.62	.700 17.78	.550 13.97	.230 5.84	60323-2
B	.100-.140 2.54-3.56	.197 5	10	.020 0.51	Tin Plated Brass	.342 8.69	.833 21.16	.662 16.81	.312 7.92	60319-2
A	.125-.165 3.18-4.19	.197 5	10	.020 0.51	Tin Plated Brass	.300 7.62	.695 17.65	.545 13.84	.230 5.84	60325-2

#### Wire Size Range 22–18 AWG [0.643–1.024 mm]

Type	Insulation Dia. Range	Hole Dia.	Stud Size	Stock Thk.	Material	Dimensions				Part Number
						W	L	E	C	
B	.125-.165 3.18-4.19	.265 6.73	1/4	.025 0.64	Tin Plated Brass	.420 10.67	.872 22.15	.662 16.81	.312 7.92	63612-1
E	—	.145 3.58	6	.025 0.64	Tin Plated Brass	.290 7.37	.500 12.7	.355 9.02	.195 4.95	63649-1
C	—	.265 6.73	1/4	.025 0.64	Tin Plated Brass	.420 10.67	.702 17.83	.492 12.5	.312 7.92	62835-1
E	—	.171 4.34	8	.025 0.64	Brass Tin Plated Brass	.290 7.37	.500 12.7	.355 9.02	.195 4.95	63446-1 63446-2

#### Wire Size Range 20–16 AWG [0.813–1.29 mm]

Type	Insulation Dia. Range	Hole Dia.	Stud Size	Stock Thk.	Material	Dimensions				Part Number
						W	L	E	C	
A	.125-.165 3.18-4.19	.171 4.34	8	.020 0.51	Tin Plated Brass	.300 7.62	.695 17.65	.545 13.84	.230 5.84	60322-2
H	—	—	8	.020 0.51	Brass	.340 8.64	1.220 30.98	.660 16.76	.500 12.7	505071-1
L	—	—	3/8	.020 0.51	Brass	.625 15.88	.939 23.85	.627 15.93	.467 11.86	505075-1
M	—	—	3/8	.020 0.51	Brass	.645 16.38	.950 24.12	.627 15.93	.467 11.86	505072-1

#### Wire Size Range 18–14 AWG [1.024–1.628 mm]

Type	Insulation Dia. Range	Hole Dia.	Stud Size	Stock Thk.	Material	Dimensions				Part Number
						W	L	E	C	
B	.100-.140 2.54-3.56	.171 4.34	8	.020 0.51	Brass	.342 8.69	.833 21.16	.662 16.81	.312 7.92	60320-1
	.100-.140 2.54-3.56	.171 4.34	8	.020 0.51	Tin Plated Brass	.342 8.69	.833 21.16	.662 16.81	.312 7.92	60320-2
D	.100-.140 2.54-3.56	.197 5	10	.020 0.51	Brass	.342 8.69	.833 21.16	.662 16.81	.312 7.92	60318-1
	.080-.120 2.03-3.05	.173 4.39	8	.028 0.71	Lu-Bronze <sup>1</sup>	.370 9.4	.915 23.24	.730 18.54	.380 9.65	485079-1
D	.080-.120 2.03-3.05	.185 4.7	8	.028 0.71	Lu-Bronze <sup>1</sup>	.365 9.27	.882 22.4	.700 17.78	.380 9.65	485044-1

<sup>1</sup>High conductivity copper-tin-zinc alloy.

#### Wire Range 17–13.5 AWG [1.151–1.78 mm]

Type	Insulation Dia. Range	Hole Dia.	Stud Size	Stock Thk.	Material	Dimensions				Part Number
						W	L	E	C	
F	—	—	8	.020 0.51	Brass	.310 7.87	.692 17.58	.505 12.83	.312 7.92	63147-1
	—	—	8	.020 0.51	Tin Plated Brass	.310 7.87	.692 17.58	.505 12.83	.312 7.92	63147-2*

\*Available on request

#### Wire Size Range 14–12 AWG [1.628–2.05 mm] or (2) 15 AWG [1.45 mm]

Type	Insulation Dia. Range	Hole Dia.	Stud Size	Stock Thk.	Material	Dimensions				Part Number
						W	L	E	C	
G	—	—	8	.025 0.64	Brass	.342 8.69	.945 24.00	.750 19.05	.570 14.48	62755-1

Dimensions are in inches and millimeters unless otherwise specified. Values in brackets are metric equivalents.

Dimensions are shown for reference purposes only. Specifications subject to change.

Technical Support  
USA: 1-800-522-6752  
Canada: 1-905-475-6222  
Mexico: 01-800-733-8926

www.tycoelectronics.com

## AMPLIVAR Terminals (Continued)

### Stud Retaining Terminals

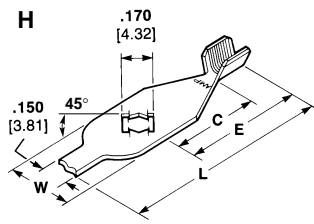

#### Wire Size Range 13–11 AWG [1.83–2.3 mm]

Type	Insulation Dia. Range	Hole Dia.	Stud Size	Stock Thk.	Material	Dimensions				Part Number
						W	L	E	C	
A	.085-.150 2.16-3.81	.180 4.57	8	.025 0.64	Brass	.342 8.69	.833 21.16	.662 16.81	.312 7.92	61710-1
C	—	.180 4.57	8	.025 0.64	Tin Plated Brass	.342 8.69	.665 16.89	.495 12.57	.312 7.92	350571-1
		.197 5.00	10	.025 0.64	Tin Plated Brass	.342 8.69	.665 16.89	.495 12.57	.312 7.92	640212-1



#### Wire Range (1) 18 AWG [1.024 mm] and (1) 20.5 AWG [0.768 mm]

Type	Insulation Dia. Range	Hole Dia.	Stud Size	Stock Thk.	Material	Dimensions				Part Number
						W	L	E	C	
J	—	—	8	.020 0.51	Brass	.340 8.64	.955 24.26	.660 16.76	.500 12.7	505044-1



#### Wire Range (2) 17 AWG [1.51 mm] or (2) 15 AWG [1.45 mm]

Type	Insulation Dia. Range	Hole Dia.	Stud Size	Stock Thk.	Material	Dimensions				Part Number
						W	L	E	C	
B	.150-.190 or (2) .115 3.18-4.83 or (2) 2.92	.171 4.34	8	.025 0.64	Tin Plated Brass	.342 8.69	.827 21.01	.656 16.66	.312 7.92	60752-2
		.197 5.00	10	.025 0.64	Tin Plated Brass	.342 8.69	.827 21.01	.656 16.66	.312 7.92	61151-1



#### Wire Range 16–13.5 AWG [1.29–1.78 mm]

Type	Insulation Dia. Range	Hole Dia.	Stud Size	Stock Thk.	Material	Dimensions				Part Number
						W	L	E	C	
K	—	—	10	.020 0.51	Brass	.340 8.64	1.220 30.99	.660 16.76	.500 12.7	505079-1



#### Wire Range 14.5 AWG [1.539 mm]

Type	Insulation Dia. Range	Hole Dia.	Stud Size	Stock Thk.	Material	Dimensions				Part Number
						W	L	E	C	
N	—	—	2	.025 0.64	Tin Plated Brass	.240 6.1	.620 15.75	.500 12.7	.165 4.19	505036-1
			2	.025 0.64	Brass	.240 6.1	.620 15.75	.500 12.7	.165 4.19	505036-3

### Alternator Eyelet Terminal



#### Wire Range (2) 13 AWG [1.83 mm]

Type	Insulation Dia. Range	Hole Dia.	Stud Size	Stock Thk.	Material	Dimensions				Part Number
						W	L	E	C	
B	.150-.190 3.81-4.83	.171 4.34	8	.025 0.64	Tin Plated Brass	.342 8.69	.827 21.00	.656 16.66	.312 7.92	63864-1

### AMPLIVAR Terminals (Continued)

#### 125 Series Blade

##### Stock Thickness

A = .013 [0.33]  
B = .020 [0.51]

Mates with Power Blade Receptacle terminals 61603-1, 61604-1, 770642-1 and 1217039-1

##### Housings

Contact Tyco Electronics Engineering for housing options available



Type	Magnet Wire Range				Material	Material Thickness	Part Number
	AWG	mm <sup>2</sup>	Solid Dia.	CMA			
A	27-20.5	0.10-0.45	.015-.030 0.35-0.75	200-850	Tin Plated Brass	.013 0.33	63871-1
	24-18	0.2-0.8	.020-.040 0.50-1.00	400-1600	Tin Plated Brass	.013 0.33	63889-1
	18.5-13.5	0.75-2.5	.040-.070 0.50-1.80	1500-5000	Tin Plated Brass	.016 0.41	63870
B	27-20.5	0.10-0.45	.015-.030 0.35-0.75	200-850	Tin Plated Brass	.013 0.33	1217072-1
	24-18	0.2-0.8	.020-.040 0.50-1.00	400-1600	Tin Plated Brass	.020 0.51	1217029-1
	18.5-13.5	0.75-2.5	.040-.070 0.50-1.80	1500-5000	Tin Plated Brass	.020 0.51	1217073-1

#### 187 Series FASTON Tabs<sup>1</sup>

##### Board Thickness

A = .062-.072 [1.57-1.83]

##### Stock Thickness

A = .020 [0.51]  
B = .032 [0.81]

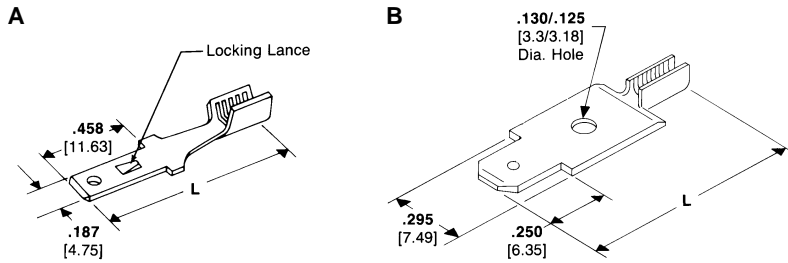

Type	Wire Range		Material	Dim. L	Part Number
	AWG	mm <sup>2</sup>			
B	27-23	0.1-0.2	Tin Plated Brass	.935 23.75	63484-1 <sup>2</sup>
	24-21	0.2-0.4	Tin Plated Brass	.935 23.75	61440-3 <sup>†</sup>
A	22-16	0.3-1.4	Tin Plated Brass	1.015 25.78	62447-1
	15-13	1.6-2.6	Tin Plated Brass	.935 23.75	61442-3 <sup>†</sup>
	15-12	1.6-3.0	Tin Plated Brass	1.015 25.78	62445-1

<sup>2</sup> Varnish resist coating.

<sup>†</sup> These part numbers are available upon special request, contact Tyco Electronics Engineering for details.

#### 250 Series FASTON Tabs<sup>1</sup>

##### Stock Thickness

.032 [0.81]

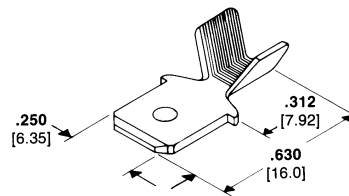

Wire Range	Material	Part Number	Quick-Change Applicator <sup>3</sup>
14-12	Tin Plated Brass	62922-1 <sup>2</sup>	466510-1

<sup>2</sup> Varnish resist coating.

<sup>3</sup> Quick-Change Applicator for AMP-O-LECTRIC Machine 565435-5. For AMPOMATOR Machine and other machines not listed, contact Tyco Electronics.

<sup>1</sup>Mates with FASTON receptacles. See AMP Catalog 82004.

**AMPLIVAR Terminals** (Continued)

**250 Series FASTON Tabs<sup>1</sup>**

(Continued)

**Stock Thickness**

.032 [0.81]

<sup>1</sup> Mates with FASTON receptacles.  
See AMP Catalog 82004.



Wire Range		Material	Dimensions				Part Number
AWG	mm <sup>2</sup>		W	L	E	T	
28-23.5	0.08-0.2	Tin Plated Brass	.250 6.35	.580 14.73	.342 8.69	45°	63136-1
25-19.5	0.16-0.6	Tin Plated Brass	.250 6.35	.650 16.51	.450 11.43	30°	63140-1
23-19	0.2-0.6	Tin Plated Brass	.250 6.35	.225 5.72	.583 14.81	15°	63165-1

**250 Series FASTON Receptacles<sup>1</sup>**

**Stock Thickness**

.016 [0.41]

<sup>1</sup> Mates with FASTON tabs.  
See AMP Catalog 82004.



Magnet Wire Range		Insulation Diameter	Mating Tab Thk.	Material	Material Thickness	Part Number	Applicator No.
CMA	mm <sup>2</sup> Dia.						
24-19	0.51-0.98	.050-.080 1.30-2.00	.020 0.51	Brass Tin Plated Brass	.016 0.41	63623-1 <sup>1</sup> 63623-2 <sup>1</sup>	567451-2 <sup>2</sup>
23-19 or (2) 24 or (2) 26	0.60-0.98 or (2) 0.57 or (2) 0.45	.050-.100 1.30-2.55	.025 0.64	Brass	.016 0.41	62069-1	567343-2 <sup>2</sup>
20-16 or (2) 23 or (2) 20	0.85-1.37 or (2) 0.63 or (2) 0.88	.100-.140 or (2) .060 Max. 2.55-3.55	.032 [0.81]	Brass Tin Plated Brass	.016 0.41	60384-1 60384-2	466010-1 <sup>2</sup>
20-16	0.85-1.37	.100-.140 2.55-3.55	.020 0.51	Brass	.016 0.41	62080-1	466010-1 <sup>2</sup>
18-14 or (2) 17	1.02-1.71	.120-.170 or (2) .060 Max. 3.05-4.30	.032 [0.81]	Tin Plated Brass	.016 0.41	60385-2	466816-1 <sup>2</sup>
18-14 or (2) 19	1.02-1.71	.120-.170 3.05-4.30	.020 0.51	Brass	.016 0.41	63622-1 <sup>1</sup>	466816-1 <sup>2</sup>
18-14 or (2) 19	1.02-1.71	.120-.170 3.05-4.30	.020 0.51	Brass	.016 0.41	1217835-1 <sup>1</sup>	466816-1 <sup>2</sup>

<sup>1</sup> Low insertion force

<sup>2</sup> Quick-Change Applicator for AMP-O-LECTRIC Machine 565435-5.



## AMPLIVAR Terminals (Continued)

### 187 Series FASTON Flag Receptacles

**Stock Thickness**

.016 [0.41]



Magnet Wire Range		Insulation Diameter	Mating Tab Thk.	Material	Material Thickness	Part Number	Applicator No.
CMA	mm <sup>2</sup> Dia.						
500-960	0.56-0.79	.020-.040 0.51-1.02	.020 0.51	Tin Plated Brass	.016 0.41	63942-1	566411-11
24-20 AWG	0.51-0.81	.020-.040 0.51-1.02	.032 0.81	Tin Plated Brass	.016 0.41	1217624-1	566411-11
1500-2350	0.99-1.22	.020-.040 0.51-1.02	.020 0.51	Tin Plated Brass	.016 0.41	63941-1	566410-11
2000-4050	1.14-1.63	.020-.040 0.51-1.02	.020 0.51	Tin Plated Brass	.016 0.41	63940-1	680353-3 <sup>2</sup>
2000-4050	1.14-1.63	.020-.040 0.51-1.02	.032 0.81	Tin Plated Brass	.016 0.41	1217417-1	680353-3 <sup>2</sup>

<sup>1</sup> Standard Applicator for "G" Splice Terminator No. 356462-2.

<sup>2</sup> Quick-Change Applicator for "G" Splice Terminator No. 356462-1.

### 250 Series FASTON Flag Receptacles

**Stock Thickness**

.018 [0.45]

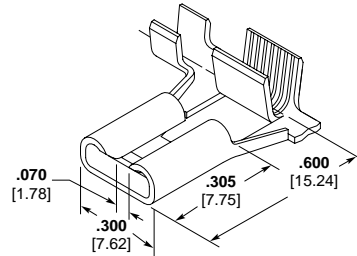

Magnet Wire Range		Insulation Diameter	Mating Tab Thk.	Material	Material Thickness	Part Number	Applicator No.
CMA	mm <sup>2</sup> Dia.						
16-12	1.29-2.13	.120-.170 3.05-4.32	.032 0.81	Tin Plated Phos Bronze	.018 0.45	63944-1	680421-3 <sup>1</sup>

<sup>1</sup> Quick-Change Applicator for "G" Splice Terminator No. 356462-1.

### Pin Receptacles

**Stock Thickness**

.016 [0.41]

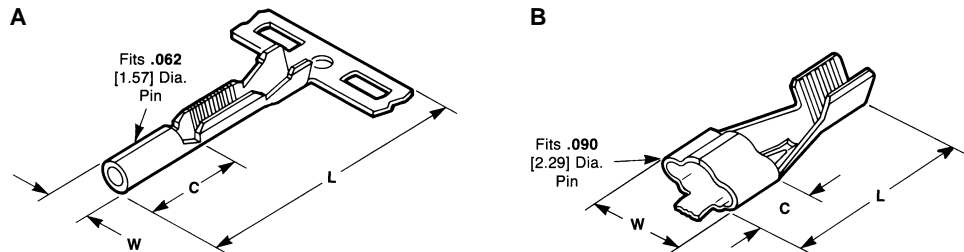

Type	Wire Range		Insulation Dia. Range	Material	Dimensions			Part Number
	AWG	mm <sup>2</sup>			W Max.	L	C	
A	29-22	0.07-0.3	.040-.060 1.02-1.52	Tin Plated Brass	.084 2.13	.590 14.99	.195 4.95	63506-1
B	21-16	0.4-1.4	—	Tin Plated Phos. Bronze	.235 5.97	.660 16.76	.250 6.35	60177-2

Dimensions are in inches and millimeters unless otherwise specified. Values in brackets are metric equivalents.

Dimensions are shown for reference purposes only. Specifications subject to change.

Technical Support  
USA: 1-800-522-6752  
Canada: 1-905-475-6222  
Mexico: 01-800-733-8926

www.tycoelectronics.com

**AMPLIVAR Terminals** (Continued)

**250 Series Stator Receptacles — 7 Serrations**



AWG	Magnet Wire Range		CMA	Mating Tab Thickness	Stock Thickness	Crimp Width	Material	Part Number
	mm <sup>2</sup>	Solid Dia.						
27-22	0.10-0.3	<b>.014-.026</b> 0.35-0.66	200-700	<b>.032</b> 0.81	<b>.018</b> 0.44	<b>.070</b> 1.77	Tin Plated Brass	63480-1
21-15	0.4-1.6	<b>.028-.060</b> 0.71-1.52	800-3600	<b>.032</b> 0.81	<b>.018</b> 0.44	<b>.110</b> 2.79	Tin Plated Brass	62381-1
22-15.5	0.3-1.5	<b>.053-.086</b> 1.35-2.18	2800-7400	<b>.032</b> 0.81	<b>.018</b> 0.44	<b>.155</b> 3.94	Tin Plated Brass	63964-1

**Stator Terminal — Receptacle .250 x .032 [6.35 x 0.81]**

- ① **Stator Terminal** with Receptacle .250 x .032 [6.35 x 0.81]
- ② **Plastic Cavity**  
Production only according to Tyco Electronics Specifications (Contact Tyco Electronics Engineering for details).  
For design and material selection Tyco Electronics Engineering **has to be** contacted before decision.  
The terminal is separated from the strip and placed automatically into the cavity.



- ③ **Wire Clamping Barrel**  
The magnet wire is positioned via posts into the AMPLIVAR crimp barrel and fixed inside clamping barrel.
- ④ **AMPLIVAR Crimp**  
The AMP application equipment crimps the AMPLIVAR connection and cuts the extending clamping barrel in one operation.



**Additional versions upon request.**  
**Application Tooling for Production Line Integrating available upon request.**

## Cluster Blocks

### Product Facts

- Pin receptacle terminals available in tin-plated phosphor bronze
- Versions available to accept .090 [2.29] and .125 [3.18] header pins
- Accepts wire range 18–16 AWG [0.8–1.4 mm<sup>2</sup>] and 14–12 AWG [2.0–3.0 mm<sup>2</sup>]
- Thermoplastic polyester housing
- Impervious to many oils and refrigerants
- Insulation compatibility
- Housings available to accept standard and reversed header pin layouts
- High-performance electrical and mechanical contact
- High-impact resistance housings
- Assemblies accept pins from one side only to prevent reversed polarity
- High-speed application of pin receptacle terminals with AMP automatic terminating machines and quick-change applicators for high volume production rates at the lowest installed cost
- Pin receptacle terminals are easily removed from the housing for maintenance and repair
- Recognized under the Component Program of Underwriters Laboratories Inc., File No. E28476



Tyco Electronics features AMP Cluster Blocks that offer manufacturers of air conditioning and refrigeration products a low-cost, fully insulated, quick-connect means for electrically connecting sealed hermetic header pins on compressors. Cluster Blocks feature high impact resistance to shock and abuse, and long-life performance in the presence of oils and refrigerants. Since the connectors accept pins from only one side, the danger of reversing polarity at the time of installation is prevented.



The one-piece housings are molded from thermoplastic polyester. The connector accepts .090 [2.29] and .125 [3.18] diameter pin sizes in either standard or reverse pin layouts. Housings accept both lead wire and AMPLIVAR direct connect pin receptacle

terminals made from phosphor bronze material. These are precision formed and available on reels for high-speed application. High retention pin receptacle terminals are available to provide optimum terminal retention in housings.

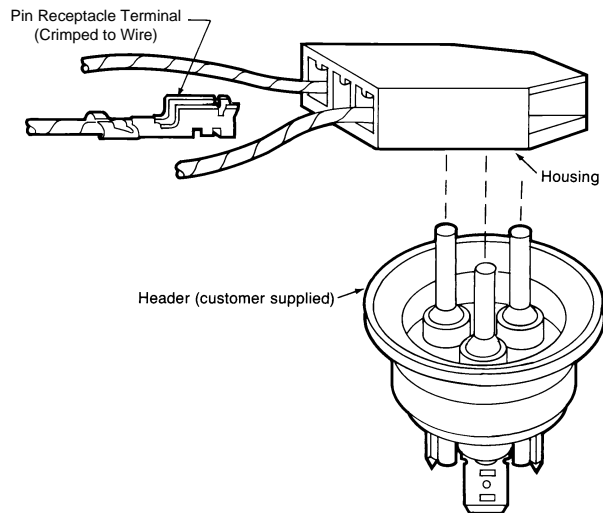

Typical Assembly

Cluster Blocks

**Cluster Blocks .090 [2.29] Pin Size (Lead Wire)**

**Housings**



Type	Center Pin Position	Header Pin Circle Dia.	Dim. L	Dim. W	Dim. H	Dim. K	Material	Part Number
A	Forward	.530 13.46	1.245 31.60	.710 18.05	.355 9.00	.850 21.60	PBT Polyester 15% Glass Reinforced	1217263-1
	Forward	.530 13.46	1.240 31.50	.710 18.05	.320 8.15	.840 21.35	PBT Polyester 15% Glass Reinforced	360050-1
	Forward	.530 13.46	1.220 31.00	.695 17.65	.260 6.60	.820 20.85	PBT Polyester 15% Glass Reinforced	521078-1
B	Back	.530 13.46	1.225 31.10	.810 20.55	.320 8.15	.840 21.35	PBT Polyester 15% Glass Reinforced	360033-1
	Back	.530 13.46	1.200 30.50	.695 17.65	.310 7.85	.805 20.40	PBT Polyester Non-Reinforced	281006-0
C	—	.683 17.35	1.490 37.85	.900 22.85	.355 9.00	.845 21.45	PBT Polyester 15% Glass Reinforced	1217262-1

**Pin Receptacles**



Type	AWG/ mm <sup>2</sup>	Wire Range Solid Dia.	CMA	Crimp Width	Insulation Diameter	Crimp Width	Stock Thickness	Material	Part Number
A	22-14	.025-.065	—	.100	.080-.150	.130	.016	Tin Plated Phos Bronze	1217264-1
	0.3-2.0	0.65-1.65	—	2.54	2.00-3.80	3.30	0.41		
B	18-16	.040-.050	—	.110	.060-.100	.140	.016	Tin Plated Phos Bronze	62131-3
	0.8-1.4	1.00-1.30	—	2.79	1.50-2.55	3.56	0.41		
B	18-16	.040-.050	—	.110	.090-.170	.180	.016	Tin Plated Phos Bronze	63448-1
	0.8-1.4	1.00-1.30	—	2.79	2.30-4.30	4.57	0.41		

**Cluster Blocks .125 [3.18] Pin Size (Lead Wire and Direct Connect)**

Housings



Pin Location  
A and D



Pin Location  
B



Pin Location  
C



A



B



C



D

Type	Center Pin Position	Header Pin Circle Dia.	Dim. L	Dim. W	Dim. H	Dim. K	Material	Part Number
A	Forward	.530 13.46	1.755 44.60	.765 19.45	.525 13.35	1.230 31.25	PBT Polyester 15% Glass Reinforced	1217181-1
	Forward	.530 13.46	1.755 44.60	.765 19.45	.470 11.95	1.230 31.25	PBT Polyester 15% Glass Reinforced	360052-1
B	Forward	.687 17.45	1.730 43.95	.895 22.75	.615 15.60	1.080 27.45	PBT Polyester 15% Glass Reinforced	1217186-1
	Forward	.687 17.45	1.595 40.50	.895 22.75	.380 9.65	1.080 27.45	PBT Polyester 15% Glass Reinforced	520995-1
C	Forward	.815 20.70	1.975 50.15	1.015 25.80	.590 15.00	1.050 26.65	PBT Polyester Non-Reinforced	1217261-1
	Back	.530 13.46	1.860 47.25	.765 19.45	.525 13.35	1.225 31.10	PBT Polyester 15% Glass Reinforced	1217200-1
D	Back	.530 13.46	1.755 44.60	.765 19.45	.470 11.95	1.225 31.10	PBT Polyester 15% Glass Reinforced	360051-1
	Back	.687 17.45	1.850 47.00	.895 22.75	.615 15.60	1.225 31.10	PBT Polyester 15% Glass Reinforced	1217187-1

Cluster Blocks

**Cluster Blocks .125 [3.18] Pin Size (Lead Wire and Direct Connect)** (Continued)

Pin Receptacles

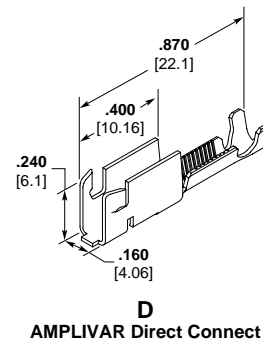

Type	AWG/ mm <sup>2</sup>	Wire Range Solid Dia.	CMA	Crimp Width	Insulation Diameter	Crimp Width	Stock Thickness	Material	Part Number
A	18-16 0.8-1.4	.040-.050 1.00-1.30	—	.110 2.79	.090-.130 2.30-3.30	.155 3.94	.020 0.51	Tin Plated Phos Bronze	62244-3
	18-16 0.8-1.4	.040-.050 1.00-1.30	—	.110 2.79	.090-.130 2.30-3.30	.155 3.94	.020 0.51	Phos Bronze	62244-5
B	14-10 2.0-6.0	.065-.100 1.60-2.60	—	.140 3.56	.130-.170 3.30-4.30	.180 4.57	.020 0.51	Tin Plated Phos Bronze	62243-3
	18-16 0.8-1.4	.040-.050 1.00-1.30	—	.110 2.79	.090-.130 2.30-3.30	.155 3.94	.020 0.51	Tin Plated Phos Bronze	1217176-1
C	14-10 2.0-6.0	.065-.100 1.60-2.60	—	.140 3.56	.130-.170 3.30-4.30	.170 4.32	.020 0.51	Tin Plated Phos Bronze	1217175-1
	—	.020-.040 0.50-1.00	400-1600	.090 2.27	.060-.100 1.50-2.55	.140 3.56	.020 0.51	Tin Plated Phos Bronze	63908-1
D	—	.020-.040 0.50-1.00	400-1600	.090 2.27	.060-.100 1.50-2.55	.140 3.56	.020 0.51	Tin Plated Phos Bronze	63453-1
	—	.040-.065 1.00-1.65	1500-4200	.110 2.79	.075-.125 1.90-3.20	.155 3.94	.020 0.51	Tin Plated Phos Bronze	63907-1
A	—	.040-.065 1.00-1.65	1500-4200	.110 2.79	.075-.125 1.90-3.20	.155 3.94	.020 0.51	Tin Plated Phos Bronze	63454-1
	—	.065-.090 1.65-2.30	4000-8500	.140 3.56	.090-.170 2.30-4.30	.170 4.32	.020 0.51	Tin Plated Phos Bronze	63906-1
B	—	.065-.090 1.65-2.30	4000-8500	.140 3.56	.090-.170 2.30-4.30	.170 4.32	.020 0.51	Tin Plated Phos Bronze	63455-1
	—	.065-.090 1.65-2.30	4000-8500	.160 4.06	.090-.170 2.30-4.30	.170 4.32	.020 0.51	Tin Plated Phos Bronze	1217122-1
C	—	.020-.040 0.50-1.00	400-1600	.090 2.27	.060-.100 1.50-2.55	.140 3.56	.020 0.51	Tin Plated Phos Bronze	1217670-1
	—	.020-.040 0.50-1.00	400-1600	.090 2.27	.060-.100 1.50-2.55	.140 3.56	.020 0.51	Tin Plated Phos Bronze	1217172-1
D	—	.040-.065 1.00-1.65	1500-4200	.110 2.79	.075-.125 1.90-3.20	.155 3.94	.020 0.51	Tin Plated Phos Bronze	1217671-1
	—	.040-.065 1.00-1.65	1500-4200	.110 2.79	.075-.125 1.90-3.20	.155 3.94	.020 0.51	Tin Plated Phos Bronze	1217174-1
A	—	.065-.090 1.65-2.30	4000-8500	.140 3.56	.090-.170 2.30-4.30	.170 4.32	.020 0.51	Tin Plated Phos Bronze	1217672-1
	—	.065-.090 1.65-2.30	4000-8500	.140 3.56	.110-.150 2.80-3.80	.170 4.32	.020 0.51	Tin Plated Phos Bronze	1217173-1

**AMPLIVAR and Cluster Blocks Application Tooling**

**AMPLIVAR Product Terminator (APT)**

**Product Facts**

- No need to strip magnet wire
- Connects up to 3 wires in 1 splice
- Crimp Quality Monitor (CQM) system measures crimp heights
- Machine shut height easily adjusts in .0005 [0.013] increments
- Quick-change tooling without major shut-height adjustments

**Specifications**

- Weight** — Approximately 150 lb [68 kg] with CQM
- Width** — 38 [965] with CQM and product reel
- Depth** — 35 [889]
- Height** — 14 [356]
- Electrical** — 120 VAC, 60 Hz, 1 A, 1f, or 240 VAC, 50 Hz, .5 A, 1f
- Air** — 80-100 psi [5.52-7.59 bar], 22 scfm [0.000141 m3/s]

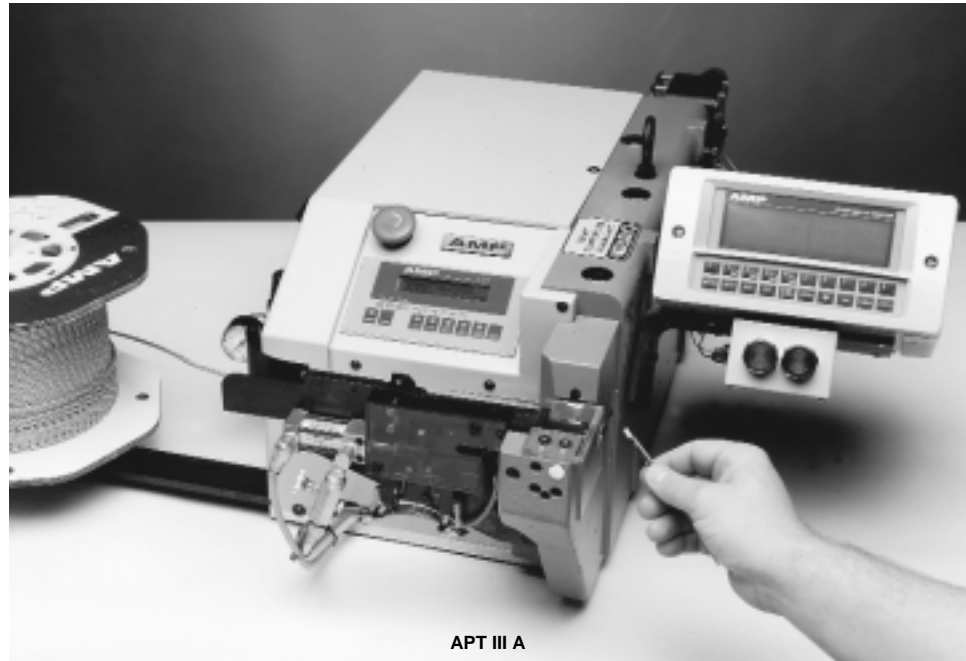

**APT III A**

For pigtail splices or direct connection of contacts to magnet wire, the AMPLIVAR Product Terminator (APT) and strip-form AMPLIVAR products offer a fast and efficient system, with no need to strip mag-wire insulation. To apply a splice or contact, simply place the wires in the target area and depress the foot switch. The machine automatically shears the splice or contact from the strip, crimps it, shears off excess wire, and advances the next splice or contact into position.

APT semi-automatic bench machines are available in two versions: the IIIA with automatic precision adjustment controlled by the Crimp Quality Monitor (CQM), and the IIE with manual precision adjustment.

With CQM, the APT IIIA assists in achieving 6-sigma processing capability. In addition to providing 100% inspection and automatic adjustment of crimp heights as needed, the CQM also evaluates the quality of each crimp. If a questionable crimp is detected, visual and audible alarms alert the operator.

For operations with multiple wire sizes, the APT IIIA provides programmable sequencing of different crimp-height settings, and it can store up to 2,000 different programs of 7 different settings each. The maximum time to auto-adjust between programmed crimp heights is 2 seconds.

The lower cost, manual adjust IIE is a simpler version without CQM capability, with the advantage of faster set-up times.

To avoid the need to change product reels when wire combinations are smaller than the CMA range of the splice or contact, an optional stuffer (part no. 679323-1 for APT IIIA, part no. 679323-2 for APT IIE.) inserts a stuffer wire into the splice or contact prior to crimping, increasing the total CMA to the recommended range. The wire stuffer unit is for pigtail splices only.



**APT III A with vertical base (679984-1) for direct connect terminals**

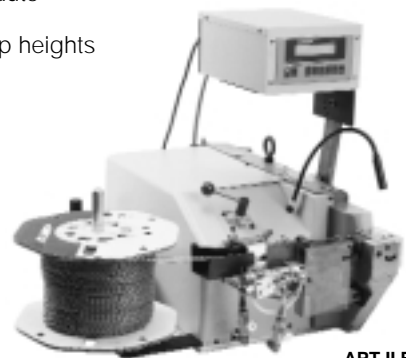

**APT IIE**

**AMPLIVAR and Cluster Blocks Application Tooling**

Dimensions are in inches and millimeters unless otherwise specified. Values in brackets are metric equivalents.

Dimensions are shown for reference purposes only. Specifications subject to change.

Technical Support  
USA: 1-800-522-6752  
Canada: 1-905-475-6222  
Mexico: 01-800-733-8926

www.tycoelectronics.com

## AMPLIVAR and Cluster Blocks Application Tooling (Continued)

### AMPLIVAR Product Terminator (APT) (Continued)

#### Machine Ordering Information

A "Base Part Number" is selected from the Basic Machine Part Numbers table. Then, a dash number or numbers are selected from one of the other two tables depending on the type of product to be applied.

**Note:** The wire stuffer is available for Pigtail-Type Splice only and may be added to the machine after installation.

679323-1 — APT IIIA  
679323-2 — APT IIE

#### Basic Machine Part Numbers

Machine Features			Base Part Number*		
Precision Adjust	Crimp Quality Monitor	Programmable Crimp-Height Sequencing	Model	Pigtail-type Splice	Direct Connect Contact
Manual	Not included	Not included	APT IIE**	□-1338906-□	□-1338907-□
Automatic	Included	Included	APT IIIA	□-679453-□	□-679457-□

\*See tables below for suffix and prefix dash numbers which indicate product to be applied, product crimp width, and voltage requirement.

\*\*Not upgradable to an APT IIIA

#### AMPLIVAR Pigtail-Type Splice Suffix and Prefix Dash Numbers

(Aluminum base 679984-1 not included)

Pigtail-type Splice Base Number	Crimp Width	120/240 VAC IIE Machine □-1338906-□	120/240 VAC IIIA Machine □-679453-□
42775			
42776	.110 [2.79]	1-( )-1	3-( )-7
42777			
42778	.110 [2.79]	1-( )-2	3-( )-8
42779	.140 [3.56]	( )-8	3-( )-4
62000	.110 [2.79]	1-( )-2	3-( )-8
62001	.140 [3.56]	( )-7	3-( )-3
62001	.180 [4.57]	( )-6	3-( )-2
62201	.140 [3.56]	( )-8	3-( )-4
62002	.180 [4.57]	( )-3	2-( )-9
62040	.110 [2.79]	1-( )-1	3-( )-7
62157			
62200	.110 [2.79]	1-( )-2	3-( )-8
62295	.250 [6.35]	( )-1	2-( )-7
62303	.080 [2.03]	1-( )-3	3-( )-9
62304			
62305	.110 [2.79]	1-( )-2	3-( )-8
62306	.140 [3.56]	1-( )-0	3-( )-6
62306			
62307	.110 [2.79]	1-( )-1	3-( )-7
62308	.140 [3.56]	( )-9	3-( )-5
62308	.180 [4.57]	( )-6	3-( )-2
62309	.220 [5.59]	5-( )-4	5-( )-3
62309	.180 [4.57]	( )-5	3-( )-1
62310	.220 [5.59]	( )-2	2-( )-8
62310	.180 [4.57]	( )-4	3-( )-0
280002	.110 [2.79]	1-( )-1	3-( )-7
280004	.110 [2.79]	1-( )-2	3-( )-8
964156	.110 [2.79]	1-( )-1	3-( )-7

#### AMPLIVAR Direct Connect Contact Suffix and Prefix Dash Numbers

(Aluminum base 679984-1 included)

Direct Connect Contact Base Number	Crimp Width	120/240 VAC IIE Machine □-1338907-□	120/240 VAC IIIA Machine □-679457-□
63453	.090 [2.286]	( )-3	( )-8
63454	.110 [2.79]	( )-2	( )-7
63455	.140 [3.56]	( )-1	( )-6
63548	.090 [2.286]	( )-5	1-( )-0
63549	.110 [2.79]	( )-4	( )-9
63906	.140 [3.56]	( )-1	( )-6
63907	.110 [2.79]	( )-2	( )-7
63908	.090 [2.286]	( )-3	( )-8
1217122	.160 [4.064]	1-( )-1	1-( )-2
1217172	.090 [2.286]	( )-3	( )-8
1217173	.140 [3.56]	( )-1	( )-6
1217174	.110 [2.79]	( )-2	( )-7
1217670	.090 [2.286]	( )-3	( )-8
1217671	.110 [2.79]	( )-2	( )-7
1217672	.140 [3.56]	( )-1	( )-6



Extraction Tool  
Part No. 274186-1



**AMPLIVAR and Cluster Blocks Application Tooling** (Continued)

**AMP-O-LECTRIC Termination Machines**



**Model "G"**

A totally new design of our most popular machine for bench-top operation. It features a quiet and highly-reliable direct motor drive, electronic controls for ease of setup and operation, and improved guarding and lighting for operator convenience and safety. All versions also include either manual or automatic precision adjustment for crimp height. For use with miniature style applicators only.

(Shown with optional Crimp Quality Monitor.)

**Specifications**

- Weight** — Approximately 240 lb [110 kg]
- Height** — 20 [508] without reel
- Width** — 18.7-25.3 [475-643] depending on type of applicator used
- Depth** — 21.5-28.1 [546-713] depending on type of applicator used
- Electrical** — 120 or 220 VAC, 50 or 60 Hz
- Air** — 90-110 psi [6.21-7.59 bar] when required for use with air-feed applicators

For complete information, request Catalog 65828.



**Model "K"**

These machines are used with standard style applicators, generally to apply one size and type of terminal without the need for frequent changeovers of applicators or adjustment of crimp height. The basic model is Part Number 1-471273-2. Part Number 1-471273-3 is equipped with a mechanical feed assembly for applicators requiring this type of feed for advancing the terminal strip.

**Specifications**

- Weight** — Approximately 230 lb [104 kg]
- Height** — 24 [610] without reel
- Width** — 21 [533]
- Depth** — 20 [508]
- Electrical** — 120 VAC, 60 Hz, 6 A
- Air** — 90-110 psi [6.21-7.59 bar] when required for use with air-feed applicators

**Crimp Quality Monitor**



This unique system provides 100% on-the-fly crimp inspection. It measures the crimp height of each termination, and evaluates the quality of each crimp. If a crimp is questionable, the monitor alerts the operator with both visual and audible alarms. It also provides ports for printing and networking.

When used with AMP-O-LECTRIC Model "G" Termination Machines, the monitor is mounted to the machine. When used with AMPOMATOR CLS IV Lead Making Machines, it is integrated into the machine's operating system, with the information displayed on the machine's touch screen.

**Specifications**

- Height** — 4.5 [114]
- Width** — 8.5 [216]
- Depth** — 9 [229]
- Electrical** — 120 VAC, 50 or 60 Hz, or 220 VAC, 50 or 60 Hz
- Printer Port** — Serial Interface

For further information, request Catalog 82275.

**AMPLIVAR and Cluster Blocks Application Tooling** (Continued)

**Model G Splice Terminating Machine, P/N 356462-2 & Applicator**



**Semiautomatic bench machine** crimps reeled splice product. Uses Standard G Splice Applicators to provide access to both sides of the splice product. Features a quiet, reliable motor drive, microprocessor controls for ease of setup and operation and guarding and lighting designed for operator convenience. Manual precision crimp height adjust is standard and machine-mounted sensors are available for crimp quality monitoring.

**Specifications**  
**AMP-O-LECTRIC Model "G" Thru Splice Terminator**

**Capacity** — 5 000 lb [2 224 N] max. crimp force  
**Deflection** — .003 [0.076] max. per 1 000 lb [445 N] crimp force  
**Noise** — 76 dB max. at 5 000 lb [2 224 N] full capacity  
**Weight** — Approx. 240 lb [109 kg]  
**Height** — 20 [508]  
**Electrical** — 120/220 VAC, 50/60 Hz; Avg. 2.6 A at 120 VAC when used as a bench-top unit at 2 000 cycles per hour operating rate  
**Air** — 90-110 psi [6.21-7.58 bar], 6 scfm [0.00283 m<sup>3</sup>/s] (when required for use with air-feed applicators)  
 For more information, order Catalog 889021.

**Standard G Splice Applicator**  
*Available for the AMP-O-LECTRIC Model G splice terminator only.*

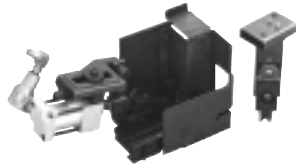

**Two-piece applicator** for crimping end- or side-feed reeled splice products. Provides access to both sides of splice for increased ease of use and productivity. Applicators use an air feed mechanism.

**Entry Level Terminator (ELT), 1338600-(x)**



Semiautomatic Bench Terminator for side- and end-feed reeled terminals and contacts. The ELT uses a DC motor with gear box drive. The result is a small-footprint design that is fast and quiet. Cycle time is less than 0.400 sec. with an operation sound level of 76dBa. With a crimp force capacity of 3,000 pounds, the ELT is available for all but the highest crimp force applications. Optional equipment is also available to meet your specific application requirements.

**Specifications**

**Width**—16.8 [427]  
**Depth**—20.6 [523]  
**Height**—20 [510] w/o reel support  
**Weight**—approx. 150 lb [68 kg]  
**Electrical**—100-240 VAC, 50/60 Hz, 6 A (Note: Avg <1 A at 120 VAC when used as a bench-top unit at 2,000 cycles per hour operating rate)  
**Air**—90-100 psi [6.21-6.90 bar], 6 scfm [0.00282 m<sup>3</sup>/s] when required for use with air-feed applicators (Note: Optional Air Feed Valve Assembly Required)  
**Wire Range**—Up to 14 AWG [2.5 mm<sup>2</sup>]  
 For more information, request catalog 1308382.

**AMPLIVAR and Cluster Blocks Application Tooling** (Continued)**Applicators****End- and Side-Feed Heavy-Duty Miniature (HDM) Applicators**

AMP applicators are designed to exacting specifications to produce consistent, high-quality terminations.

HDM applicators are quickly interchangeable and easily repaired. They feature simple dial-in settings for adjusting crimp height for terminating different wire combinations within the designated CMA range.

These applicators are used with both bench machines and fully-automatic lead makers. They can also be used for crimp quality monitoring on systems equipped with the CQM G-Adapter. Call the AMP Tooling Assistance Center at 1-800-722-1111 for further information.

**Standard (STD) Applicators**

Standard style applicators are generally used for long production runs using dedicated equipment, or when splicing a coil, for example, that needs to be positioned close to the crimping area in the applicator. The crimp height can be adjusted by raising or lowering the base mount.

**Standard Style Applicator for Large CMA Splice, Part Number 566372-2**

This applicator was designed specifically to apply AMP 5 000-16 000 CMA Splice, Part Number 63625-1. It features a highly-visible, close-up crimp area—less than 1 [25] from the front of the guard. You can easily splice multiple wires by

simply rotating them down through the front of the guard into the crimp area.

It is an air-feed applicator, and can be used with Model "K" Part Number 1-471273-3.

**AMPLIVAR and Cluster Blocks Application Tooling** (Continued)

**AMPOMATOR CLS IV+  
Lead-Making Machines, 356500-1, -2**



Fully-automatic machines that measure, cut, strip and terminate single leads. Microprocessor-controlled, and programmed and operated using an easy-to-follow, menu-driven touchscreen. Features include direct-drive terminating units with precision crimp height adjustment, fully programmable setups, wire runout and splice detection, and motorized pre-feed with wire straightener. Crimp quality monitoring is also available.

**Specifications**

- Width**—159 [4 040]
  - Depth**—68 [1 730]
  - Height**—86 [2 185] with 24 [610] dia. reel
  - Weight**—2 000 lb [907 kg]
  - Electrical**—220 VAC, 50 or 60 Hz, single phase, 25 A, with neutral and ground
  - Air**—90 psi [6.21 bar], 15 scfm [0.0071 m<sup>3</sup>/s] sustained
  - Wire Range**—26-10 AWG [0.12-6 mm<sup>2</sup>] stranded, 26-16 AWG [0.12-1.4 mm<sup>2</sup>] solid
  - Lead Lengths**—3-90 [76.2-2 285], 90-1 000 [2 285-25 400] with long lead conveyors
- For more information, request Catalog **124324**.

**Gamma 333 PC Lead-Making Machine, Three Stations, 1-528324-1**

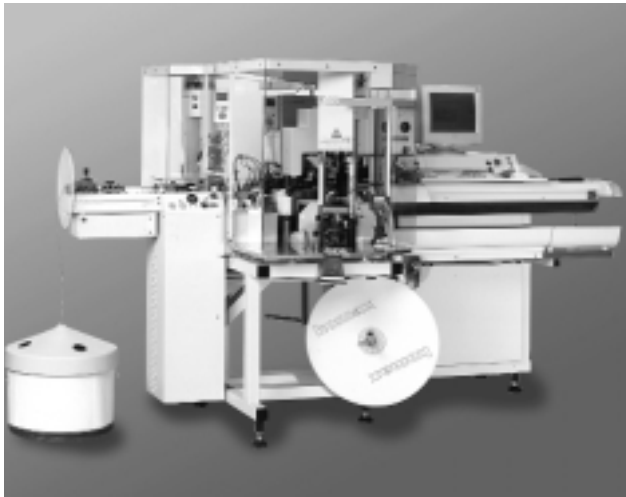

With its capacity to accommodate an additional processing station on side 1, the Gamma 333 PC can perform a number of new processes. It can produce two-ended crimp leads, process double crimp connections with three different terminals or apply seals on one end of the wire. Tinning and ink jet marking are two further options. Process monitoring is integrated into the system, for accurate trimming and stripping of the wires.

**Specifications**

- Length**—125 [3137]
  - Width**—54.2 [1377]
  - Height**—70.5 [1790]
  - Length Range**— 2.36 in-32.8 ft [60-10,000] (optional 30mm)
  - Cross-Section Range** — AWG 26-AWG 10 [0.125mm<sup>2</sup>-5mm<sup>2</sup>]
  - Noise Level**—<76dB (without crimping modules)
  - Electrical**—3x208 - 480V, 50-60Hz: 6kVA
  - Compressed Air**—5-6 bar
  - Air Consumption**—6.5m<sup>3</sup>/h
  - Weight**—1850 lbs [840 kg] with two crimping modules
- For more information, request Catalog **1307901**.

## MTM Crimband Splices

### Product Facts

- Made from a continuous coil of "Ribbon Connector" material
- Magnet wires MTM Crimband splices have machine-piercing serrations designed for displacing magnet wire insulation.
- Available in brass, tin-plated brass, and copper-nickel alloy material
- Make parallel or pigtail connections on same machine
- 100% of Crimband material is used in scrap free terminations
- Crimband material coupled with appropriate toolsets accommodate specific CMA ranges
- Produced in Tyco Electronics equipment on your production floor
- Meets UL 486C crimp tensile requirements

### Applications

- Motors windings and connections
- Coil connections
- Transformer windings and connections
- Lighting ballasts
- Power supplies



Mod I

Mod III

Tyco Electronics features the AMP MTM Crimband system that is comprised of two key features: the semi-automatic termination machine and a reel of MTM Crimband material.

In a one-step crimping operation, the machine feeds, cuts, forms and crimps the material to provide a low-cost, high reliability crimp connection.

The MTM Crimband splices are formed during the crimping process from

machined longitudinal grooved material that pierces magnet wire varnish film insulation during crimping.

MTM Crimband splices are specifically designed to terminate magnet wire to itself or in combination with standard solid or stranded lead wire.

Three magnet wires maximum can be terminated together with stranded lead wire in one splice.

Tyco Electronics provides a wide range of toolset types and Crimband splices to meet various production requirements.

Depending on your specific application, MTM Crimband splices are available in 7, 9, 11 and 13 serration versions for terminations in the 400 to 13,000 CMA range.

When aluminum magnet wire is used, MTM Crimband splices must be tin plated.



Crimband

## MTM Crimband Splices (Continued)

### MTM Crimband Interconnection System

#### How the System Operates

- ① **Feed (Magnet Wire Connector Material)**  
Machine feeds strip until the strip hits the wire stop.
- ② **Shear (Blank Length)**  
The strip is cut by the cutter block former bar insert tooling.
- ③ **Bend (Crimp Formed)**  
The former bar drives the cut strip over the anvil, bending the cut strip into an upside down "U".
- ④ **Wire (Placement)**  
In Pigtail and Parallel (Thru) splices magnet wires must be placed on top of the lead wire.
- ⑤ **Crimp (Crimp Formed)**  
The anvil retracts as the driver takes the formed strip down into the clincher.



**Notes:** To insure that the proper Crimband splice is chosen, Tyco Electronics recommends the following:

1. Submit 10 samples of wire combinations and/or components to be crimped with any special requirements to your Tyco Electronics sales representative.
2. Pull-out force and/or millivolt drop tests will be performed to insure that the proper Crimband material, toolset and crimp heights are recommended.
3. Tooling and testing will be documented on a Material & Tooling Sheet (M & T sheet).
4. Crimband material quotes, tooling quotes and samples will be submitted to the customer.

#### Connector Specification Code

See Figure 1 and/or Legend below					
Machine Basis	B.L. Dim. Tooling Size	W Dim. Connector Width	T Dim. Material Thickness	Finish	Material Code
L	092	6R	20	T	B

Splice No. Example: L 092 6R 20 T B

#### Legend

Machine Basis		
L	P	G*
Leased	Purchase	General

\* Customer has their own Tooling

Tooling Size Code	Blank Length B/L (Nom.)
032	.167
032/036	.228
036	.224
045	.246
051	.267
061	.292
061/076	.324
076	.339
076/092	.361
092	.379
092/125	.413
125	.446
125/160	.485
125/165	.506
165	.546

**Note:** For B/L above, .546 consult Tyco Electronics for tooling size code.

Connector Width Code	W
4R	5 Serrations .138
6R	7 Serrations .154
8R	9 Serrations .194
10R	11 Serrations .234

Material Thickness Code	T ±.002 Dim.	D Serration Depth
12	.012	.005
14	.014	.005
16	.016	.007
20	.020	.007
25	.025	.007

Material Code	Material/Finish
B	CDA 260 Brass
A	CDA 725 Copper/Nickel Alloy
TB	Pre-Tin over CDA 260 Brass

Wire Size AWG	UL486C Pull Out Force Requirements Underwriters Laboratory (lbs.)
26	3
24	5
22	8
20	10
18	10
16	15
14	25
12	35
10	40

**MTM Crimpband Splices** (Continued)

**11 Serrations**

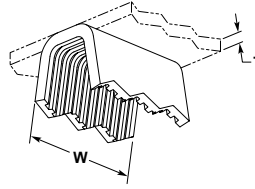

AWG/ mm <sup>2</sup>	Wire Range Solid Dia.	CMA Range	Stock Thk. (T)	Mat'l Width (W)	Material	Toolset	Part Number	Descriptive X-ref
14½-11½ 1.80-4.00	.059-.087 1.50-2.21	3500-7500	.025 0.64	.234 5.94	Brass	125/165	1601842-1	P125/ 16510R25B
14½-11½ 1.80-4.00	.059-.087 1.50-2.21	3500-7500	.025 0.64	.234 5.94	Tin Plated Brass	125/165	1601705-1	L125/ 16510R25TB
13½-10½ 2.54-4.50	.071-.097 1.70-2.46	4500-9500	.025 0.64	.234 5.94	Brass	165/200	1601847-1	P165/ 20010R25B
13½-10½ 2.54-4.50	.071-.097 1.70-2.46	4500-9500	.025 0.64	.234 5.94	Tin Plated Brass	165/200	1601848-1	P165/ 20010R25TB

**9 Serrations**

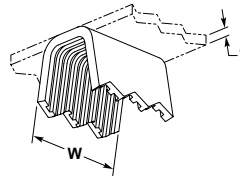

AWG/ mm <sup>2</sup>	Wire Range Solid Dia.	CMA Range	Stock Thk. (T)	Mat'l Width (W)	Material	Toolset	Part Number	Descriptive X-ref
24-20 0.20-0.50	.020-.033 0.51-0.84	400-1100	.016 0.41	.194 4.93	Tin Plated Brass	032/036	1601794-1†	P032/ 0368R16TB
20½-16 0.45-1.30	.030-.051 0.76-1.29	900-2600	.018 0.46	.194 4.93	Tin Plated Brass	061	1601607-1†	L0618R16TB
20½-16 0.45-1.30	.030-.051 0.76-1.29	900-2600	.018 0.46	.194 4.93	Brass	061	1601608-1	L0618R20B
20½-16 0.45-1.30	.030-.051 0.76-1.29	900-2600	.018 0.46	.194 4.93	Tin Plated Brass	061	1601814-1†	P0618R20TB
18-14 0.80-2.00	.040-.063 1.02-1.60	1600-4000	.016 0.41	.194 4.93	Tin Plated Brass	076	1601824-1	P0768R16TB
18-14 0.80-2.00	.040-.063 1.02-1.60	1600-4000	.020 0.51	.194 4.93	Tin Plated Brass	076	1601857-1	PO768R20TB
18-14 0.80-2.00	.040-.063 1.02-1.60	1800-4600	.020 0.51	.194 4.93	Brass	076/092	1601823-1	P076/ 0928R20B
18-14 0.80-2.00	.040-.063 1.02-1.60	1800-4600	.020 0.51	.194 4.93	Tin Plated Brass	076/092	1601639-1	L076/ 0928R20TB
16-12 1.30-3.46	.051-.078 1.29-1.98	2600-6100	.020 0.51	.194 4.93	Brass	092/125	1601833-1	P092/ 1258R20B
16-12 1.30-3.46	.051-.078 1.29-1.98	2600-6100	.020 0.51	.194 4.93	Tin Plated Brass	092/125	1601677-1	L092/ 1258R20TB
16-12 1.30-3.46	.051-.078 1.29-1.98	2600-6100	.025 0.64	.194 4.93	Brass	092/125	1601678-1†	L092/ 1258R25B
16-12 1.30-3.46	.051-.078 1.29-1.98	2600-6100	.025 0.64	.194 4.93	Tin Plated Brass	092/125	1601835-1†	P092/ 1258R25TB
15½-12 1.54-3.46	.055-.082 1.40-2.10	3000-6750	.016 0.41	.194 4.93	Brass	125	1601717-1†	L1258R16B
15½-12 1.54-3.46	.055-.082 1.40-2.10	3000-6750	.016 0.41	.194 4.93	Tin Plated Brass	125	1601718-1	L1258R16TB
15½-12 1.54-3.46	.055-.082 1.40-2.10	3000-6750	.020 0.51	.194 4.93	Brass	125	1601846-1	P1258R20B
15½-12 1.54-3.46	.055-.082 1.40-2.10	3000-6750	.025 0.64	.194 4.93	Brass	125	1601719-1	L1258R25B
14½-11½ 1.80-4.00	.059-.087 1.50-2.21	3500-7500	.025 0.64	.194 4.93	Brass	125/165	1601706-1	L125/ 1658R25B
14½-11½ 1.80-4.00	.059-.087 1.50-2.21	3500-7500	.025 0.64	.194 4.93	Tin Plated Brass	125/165	1601707-1	L125/ 1658R25TB
14-11 2.00-4.20	.063-.092 1.60-2.34	4000-8500	.025 0.64	.194 4.93	Tin Plated Brass	165	1601750-1†	L1658R25TB
11½-9 4.00-6.50	.084-.114 2.13-2.90	7000-13000	.025 0.64	.194 4.93	Tin Plated Brass	200/202	1601761-1	L200/ 2028R25TB

† These part numbers are available upon special request; contact Tyco Electronics Engineering for details.

Crimband

Dimensions are in inches and millimeters unless otherwise specified. Values in brackets are metric equivalents.

Dimensions are shown for reference purposes only. Specifications subject to change.

Technical Support  
USA: 1-800-522-6752  
Canada: 1-905-475-6222  
Mexico: 01-800-733-8926

www.tycoelectronics.com

**MTM Crimpband Splices** (Continued)

7 Serrations



AWG/ mm <sup>2</sup>	Wire Range Solid Dia.	CMA Range	Stock Thk. (T)	Mat'l Width (W)	Material	Toolset	Part Number	Descriptive X-ref
27½-21 0.09-0.40	<b>.013-.028</b> 0.33-0.71	170-800	<b>.012</b> 0.30	<b>.154</b> 3.91	Brass	032	1601800-1	P0326R12BUF <sup>1</sup>
24-20 0.20-0.50	<b>.020-.033</b> 0.51-0.84	400-1100	<b>.012</b> 0.30	<b>.154</b> 3.91	Brass	032/036	1601539-1	L032/ 0366R12B
24-20 0.20-0.50	<b>.020-.033</b> 0.51-0.84	400-1100	<b>.012</b> 0.30	<b>.154</b> 3.91	Cu Ni	032/036	1601538-1	L032/ 0366R12AUF <sup>1</sup>
24-20 0.20-0.50	<b>.020-.033</b> 0.51-0.84	400-1100	<b>.016</b> 0.41	<b>.154</b> 3.91	Brass	032/036	1601540-1	L032/ 0366R16B
24-20 0.20-0.50	<b>.020-.033</b> 0.51-0.84	400-1100	<b>.016</b> 0.41	<b>.154</b> 3.91	Tin Plated Brass	032/036	1601793-1	P032/ 0366R16TB
22-19 0.38-0.60	<b>.024-.036</b> 0.70-0.91	600-1300	<b>.016</b> 0.41	<b>.154</b> 3.91	Brass	045	1601559-1	L0456R16B
22-19 0.38-0.60	<b>.024-.036</b> 0.70-0.91	600-1300	<b>.020</b> 0.51	<b>.154</b> 3.91	Brass	045	1601560-1†	L0456R20B
20½-16 0.45-1.30	<b>.030-.051</b> 0.76-1.29	900-2600	<b>.016</b> 0.41	<b>.154</b> 3.91	Brass	061	1601604-1	L0616R16B
20½-16 0.45-1.30	<b>.030-.051</b> 0.76-1.29	900-2600	<b>.016</b> 0.41	<b>.154</b> 3.91	Tin Plated Brass	061	1601606-1	L0616R16TB
18-14 0.80-2.00	<b>.040-.063</b> 1.02-1.60	1600-4000	<b>.016</b> 0.41	<b>.154</b> 3.91	Brass	076	1601644-1	L0766R16B
18-14 0.80-2.00	<b>.040-.063</b> 1.02-1.60	1600-4000	<b>.016</b> 0.41	<b>.154</b> 3.91	Tin Plated Brass	076	1601646-1†	L0766R16TB
18-14 0.80-2.00	<b>.040-.063</b> 1.02-1.60	1600-4000	<b>.020</b> 0.51	<b>.154</b> 3.91	Brass	076	1601647-1†	L0766R20B
17½-13½ 0.95-2.54	<b>.042-.068</b> 1.07-1.80	1800-4600	<b>.016</b> 0.41	<b>.154</b> 3.91	Brass	076/092	1601637-1	L076/ 0926R16BX
16½-13 1.10-2.60	<b>.047-.072</b> 1.19-1.83	2200-5200	<b>.016</b> 0.41	<b>.154</b> 3.91	Tin Plated Brass	092	1601683-1	L0926R16TB
16-12 1.30-3.46	<b>.051-.078</b> 1.29-1.98	2600-6100	<b>.016</b> 0.41	<b>.154</b> 3.91	Tin Plated Brass	092/125	1601675-1	L092/ 1256R16TB
16-12 1.30-3.46	<b>.051-.078</b> 1.29-1.98	2600-6100	<b>.020</b> 0.51	<b>.154</b> 3.91	Brass	092/125	1601832-1	P092/ 1256R20B
15½-12 1.54-3.46	<b>.055-.082</b> 1.40-2.10	3000-6750	<b>.012</b> 0.30	<b>.154</b> 3.91	Brass	125	1601844-1	P1256R12B
15½-12 1.54-3.46	<b>.055-.082</b> 1.40-2.10	3000-6750	<b>.016</b> 0.41	<b>.154</b> 3.91	Brass	125	1601845-1	P1256R16B
15½-12 1.54-3.46	<b>.055-.082</b> 1.40-2.10	3000-6750	<b>.016</b> 0.41	<b>.154</b> 3.91	Tin Plated Brass	125	1601716-1†	L1256R16TB

<sup>1</sup> UF designates Ultra-Fine serrations which are recommended for applications using wire size 28 AWG [0.32 mm] or smaller.

† These part numbers are available upon special request; contact Tyco Electronics Engineering for details.



**RTM Crimpband Splices**

**Product Facts**

- Made from a continuous coil of "Ribbon Connector" material
- RTM Crimpband have grooved serrations for improved axial retention.
- Available in brass, tin-plated brass and copper-nickel alloy (CA725) material
- Make parallel or pigtail connections on same machine
- Used for electrical and non-electrical connections.
- 100% of RTM Crimpband material is used in scrap free terminations
- Crimpband material coupled with appropriate toolsets accommodate specific CMA ranges
- Produced in Tyco Electronics equipment on your production floor
- Meets UL 486C crimp tensile requirements

**Applications**

- Stranded and solid wire-to-wire connections
- Light bulb LED assembly
- Switch lead assembly
- Resistor lead assembly
- Printed circuit board lead assembly
- Flex-film lead assembly
- Glass reed switch lead assembly



Mod I  
Tyco Electronics features the AMP RTM Crimpband system that is comprised of two key features: the semi-automatic termination machine and a reel of RTM Crimpband material.

In a one-step crimping operation, the machine feeds, cuts, forms and crimps the material to provide a low-cost, high reliability crimp connection. The RTM Crimpband splices are formed during the crimping process from

milled longitudinal groove material that produce rolled, rounded serrations. They are designed to terminate pre-stripped stranded and solid wire conductors together as well as wire conductors to switch tabs, resistors, printed circuit board, flex circuit and light bulb LED and glass reed switch assemblies, etc. The flexibility of the RTM Crimpband system provides opportunity for use in custom applications for

Mod III  
either electrical and / or mechanical connections. Tyco Electronics provides a wide range of toolset types and crimpband splices to meet various production requirements. Depending on your specific application, RTM Crimpband splices are available in 3, 6, 7, 8, 9, 10 14 and 20 ridge serration versions for terminations in the 170 to 13,000 CMA range.



Dimensions are in inches and millimeters unless otherwise specified. Values in brackets are metric equivalents.

Dimensions are shown for reference purposes only. Specifications subject to change.

Technical Support  
USA: 1-800-522-6752  
Canada: 1-905-475-6222  
Mexico: 01-800-733-8926

www.tycoelectronics.com

## RTM Crimpband Splices (Continued)

### RTM Crimpband Interconnection System

#### How the System Operates

- ① **Feed (Ribbon Connector Material)**  
Machine feeds strip until the strip hits the wire stop.
- ② **Shear (Blank Length)**  
The strip is cut by the cutter block former bar insert tooling.
- ③ **Bend (Crimp Formed)**  
The former bar drives the cut strip over the anvil, bending the cut strip into an upside down "U".
- ④ **Wire (Placement)**  
Pigtail and Parallel (Thru) splice terminations are made on the same machine.
- ⑤ **Crimp (Crimp Formed)**  
The anvil retracts as the driver takes the formed strip down into the clincher.

**Notes:** To insure that the proper Crimpband splice is chosen, Tyco Electronics recommends the following:

1. Submit 10 samples of wire combinations and/or components to be crimped with any special requirements to your Tyco Electronics sales representative.
2. Pull-out force and/or millivolt drop tests will be performed to insure that the proper Crimpband material, toolset and crimp heights are recommended.
3. Tooling and testing will be documented on a Material & Tooling Sheet (M & T sheet).
4. Crimpband material quotes, tooling quotes and samples will be submitted to the customer.



#### Connector Specification Code

See Figure 1 and/or Legend below

Machine Basis	B.L. Dim. Tooling Size	W Dim. Connector Width	T Dim. Material Thickness	Material
L	092	F	20	TCRS

Splice No. Example: L 092 F 20 TCRS

#### Legend

Machine Basis	
L	P
Leased	Purchase
Tooling Size Code	Blank Length B/L (Nom.)
032	.167
032/036	.228
036	.224
045	.246
051	.267
061	.292
061/076	.324
076	.339
076/092	.361
092	.379
092/125	.413
125	.446
125/160	.485
125/165	.506
165	.546

Connector Width Code	W Dim.	N No. of Ridges
B	.076	3
C	.138	6
D	.154	7
E	.185	8
F	.216	9
G	.234	10
H	.247	10
L	.086	3
M	.330	14
N	.500	20
P	.114	5

Material Thickness Code	T ±.002 Dim.
12	.012
16	.016
18	.018
20	.020
22	.022
24	.024
25	.025

Material Code	Material/Finish
B	CDA 260 Brass
A	CDA 725 Copper/Nickel Alloy
TB	Pre-Tin over CDA 260 Brass
TCRS	1010 Cold Rolled Steel, Tin Plated
SS	301 or 302 Stainless Steel
ST	Stainless Steel, Tin Plated

Wire Size AWG	UL486C Pull Out Force Requirements Underwriters Laboratory (lbs.)
26	3
24	5
22	8
20	10
18	10
16	15
14	25
12	35
10	40

**Note:** For B/L above, .546 consult factory for tooling size code

**RTM Crimpband Splices** (Continued)

20 Ridges



AWG/ mm <sup>2</sup>	Wire Range Solid Dia.	CMA Range	Stock Thk. (T)	Mat'l Width (W)	Material	Toolset	Part Number	Descriptive X-ref
11½-9 4.00-6.50	.084-.114 2.13-2.90	7000-13000	.020 0.51	.500 12.70	Tin Plated Brass	200/202	1601771-1	L200/202N20TB

14 Ridges



AWG/ mm <sup>2</sup>	Wire Range Solid Dia.	CMA Range	Stock Thk. (T)	Mat'l Width (W)	Material	Toolset	Part Number	Descriptive X-ref
22-19 0.38-0.60	.024-.036 0.61-0.91	600-1300	.012 0.30	.330 8.38	Cu Ni	045	1601577-1†	L045M12A
22-19 0.38-0.60	.024-.036 0.61-0.91	600-1300	.012 0.30	.330 8.38	Brass	045	1601578-1	L045M12B

† These part numbers are available upon special request; contact Tyco Electronics Engineering for details.

10 Ridges

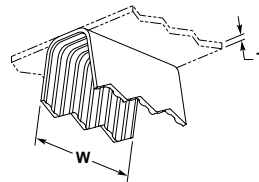

AWG/ mm <sup>2</sup>	Wire Range Solid Dia.	CMA Range	Stock Thk. (T)	Mat'l Width (W)	Material	Toolset	Part Number	Descriptive X-ref
22-19 0.38-0.60	.024-.036 0.61-0.91	600-1300	.012 0.30	.234 5.94	Brass	045	1601575-1	L045G12B
21-18½ 0.40-0.75	.028-.039 0.71-0.99	800-1500	.016 0.41	.234 5.94	Cu Ni	051	1601593-1†	L051G16A
20½-16 0.45-1.30	.030-.051 0.76-1.29	900-2600	.012 0.30	.234 5.94	Brass	061	1601632-1†	L061G12B
20½-16 0.45-1.30	.030-.051 0.76-1.29	900-2600	.020 0.51	.234 5.94	Brass	061	1601633-1	L061G20B
11½-9 4.00-6.50	.084-.114 2.13-2.90	7000-13000	.020 0.51	.234 5.94	Brass	200/202	1601853-1	P200/ 202G20B
11½-9 4.00-6.50	.084-.114 2.13-2.90	7000-13000	.025 0.64	.234 5.94	Brass	200/202	1601769-1	L200/ 202G25BX

† These part numbers are available upon special request; contact Tyco Electronics Engineering for details.

**RTM Crimpband Splices** (Continued)

**9 Ridges**



AWG/ mm <sup>2</sup>	Wire Range Solid Dia.	CMA Range	Stock Thk. (T)	Mat'l Width (W)	Material	Toolset	Part Number	Descriptive X-ref
22-19 0.38-0.60	<b>.024-.036</b> 0.61-0.91	600-1300	<b>.012</b> 0.30	<b>.216</b> 5.49	Stainless Steel	045	1601807-1	P045F12SS
20½-16 0.45-1.30	<b>.030-.051</b> 0.76-1.29	900-2600	<b>.012</b> 0.30	<b>.216</b> 5.49	Stainless Steel	061	1601520-1	G061F12SS

**8 Ridges**



AWG/ mm <sup>2</sup>	Wire Range Solid Dia.	CMA Range	Stock Thk. (T)	Mat'l Width (W)	Material	Toolset	Part Number	Descriptive X-ref
24-20 0.20-0.50	<b>.020-.033</b> 0.51-0.84	400-1100	<b>.012</b> 0.30	<b>.185</b> 4.70	Cu Ni	032/036	1601553-1	L032/ 036E12A
18-14 0.80-2.00	<b>.040-.063</b> 1.02-1.60	1600-4000	<b>.018</b> 0.46	<b>.185</b> 4.70	Tin Plated CRS	076	1601669-1	L076E18TCRS
11½-9 4.00-6.50	<b>.084-.114</b> 2.13-2.90	7000-13000	<b>.024</b> 0.61	<b>.185</b> 4.70	Brass	200/202	1601768-1	L200/ 202E24B

**7 Ridges**



AWG/ mm <sup>2</sup>	Wire Range Solid Dia.	CMA Range	Stock Thk. (T)	Mat'l Width (W)	Material	Toolset	Part Number	Descriptive X-ref
24-20 0.20-0.50	<b>.020-.033</b> 0.51-0.84	400-1100	<b>.012</b> 0.30	<b>.154</b> 3.91	Brass	032/036	1601550-1	L032/ 036D12B
24-20 0.20-0.50	<b>.020-.033</b> 0.51-0.84	400-1100	<b>.016</b> 0.41	<b>.154</b> 3.91	Cu Ni	032/036	1601551-1	L032/ 036D16A
24-20 0.20-0.50	<b>.020-.033</b> 0.51-0.84	400-1100	<b>.016</b> 0.41	<b>.154</b> 3.91	Brass	032/036	1601797-1	P032/ 036D16B
24-20 0.20-0.50	<b>.020-.033</b> 0.51-0.84	400-1100	<b>.016</b> 0.41	<b>.154</b> 3.91	Tin Plated Brass	032/036	1601798-1	P032/ 036D16TB
22-19 0.38-0.60	<b>.024-.036</b> 0.61-0.91	600-1300	<b>.012</b> 0.30	<b>.154</b> 3.91	Brass	045	1601572-1	L045D12B
22-19 0.38-0.60	<b>.024-.036</b> 0.61-0.91	600-1300	<b>.016</b> 0.41	<b>.154</b> 3.91	Cu Ni	045	1601573-1	L045D16A

**RTM Crimpband Splices** (Continued)

**7 Ridges** (Continued)



AWG/ mm <sup>2</sup>	Wire Range Solid Dia.	CMA Range	Stock Thk. (T)	Mat'l Width (W)	Material	Toolset	Part Number	Descriptive X-ref
22-19 0.38-0.60	<b>.024-.036</b> 0.61-0.91	600-1300	<b>.016</b> 0.41	<b>.154</b> 3.91	Brass	045	1601507-1†	G045D16B
21-18½ 0.40-0.75	<b>.028-.039</b> 0.71-0.99	800-1500	<b>.012</b> 0.30	<b>.154</b> 3.91	Brass	051	1601587-1	L051D12B
21-18½ 0.40-0.75	<b>.028-.039</b> 0.71-0.99	800-1500	<b>.016</b> 0.41	<b>.154</b> 3.91	Brass	051	1601588-1	L051D16B
21-18½ 0.40-0.75	<b>.028-.039</b> 0.71-0.99	800-1500	<b>.020</b> 0.51	<b>.154</b> 3.91	Nickel Plated Steel	051	1601591-1	L051D20NPS
21-18½ 0.40-0.75	<b>.028-.039</b> 0.71-0.99	800-1500	<b>.020</b> 0.51	<b>.154</b> 3.91	Tin Plated CRS	051	1601811-1†	P051D20TCRS
20½-16 0.45-1.30	<b>.030-.051</b> 0.76-1.29	900-2600	<b>.012</b> 0.30	<b>.154</b> 3.91	Cu Ni	061	1601818-1†	P061D12A
20½-16 0.45-1.30	<b>.030-.051</b> 0.76-1.29	900-2600	<b>.012</b> 0.30	<b>.154</b> 3.91	Brass	061	1601620-1†	L061D12B
20½-16 0.45-1.30	<b>.030-.051</b> 0.76-1.29	900-2600	<b>.012</b> 0.30	<b>.154</b> 3.91	Tin Plated Brass	061	1601514-1†	G061D12TB
20½-16 0.45-1.30	<b>.030-.051</b> 0.76-1.29	900-2600	<b>.016</b> 0.41	<b>.154</b> 3.91	Cu Ni	061	1601819-1	P061D16A
20½-16 0.45-1.30	<b>.030-.051</b> 0.76-1.29	900-2600	<b>.016</b> 0.41	<b>.154</b> 3.91	Brass	061	1601820-1	P061D16B
20½-16 0.45-1.30	<b>.030-.051</b> 0.76-1.29	900-2600	<b>.016</b> 0.41	<b>.154</b> 3.91	Tin Plated Brass	061	1601623-1	L061D16TB
20½-16 0.45-1.30	<b>.030-.051</b> 0.76-1.29	900-2600	<b>.018</b> 0.46	<b>.154</b> 3.91	Brass	061	1601625-1	L061D18B
20½-16 0.45-1.30	<b>.030-.051</b> 0.76-1.29	900-2600	<b>.018</b> 0.46	<b>.154</b> 3.91	Tin Plated Brass	061	1601628-1	L061D18TB
20½-16 0.45-1.30	<b>.030-.051</b> 0.76-1.29	900-2600	<b>.020</b> 0.51	<b>.154</b> 3.91	Cu Ni	061	1601629-1	L061D20A
20½-16 0.45-1.30	<b>.030-.051</b> 0.76-1.29	900-2600	<b>.020</b> 0.51	<b>.154</b> 3.91	Brass	061	1601630-1	L061D20B
20½-16 0.45-1.30	<b>.030-.051</b> 0.76-1.29	900-2600	<b>.020</b> 0.51	<b>.154</b> 3.91	Tin Plated Brass	061	1601631-1	L061D20TBX
20-15 0.60-1.60	<b>.033-.057</b> 0.84-1.45	1100-3200	<b>.016</b> 0.41	<b>.154</b> 3.91	Brass	061/076	1601601-1	L061/076D16B
19½-14½ 0.60-1.80	<b>.035-.061</b> 0.89-1.54	1200-3700	<b>.016</b> 0.41	<b>.154</b> 3.91	Brass	061/092	1601603-1	L061/092D16B
18-14 0.80-2.00	<b>.040-.063</b> 1.02-1.60	1600-4000	<b>.012</b> 0.30	<b>.154</b> 3.91	Cu Ni	076	1601828-1	P076D12A
18-14 0.80-2.00	<b>.040-.063</b> 1.02-1.60	1600-4000	<b>.012</b> 0.30	<b>.154</b> 3.91	Brass	076	1601655-1†	L076D12B
18-14 0.80-2.00	<b>.040-.063</b> 1.02-1.60	1600-4000	<b>.016</b> 0.41	<b>.154</b> 3.91	Cu Ni	076	1601656-1	L076D16A
18-14 0.80-2.00	<b>.040-.063</b> 1.02-1.60	1600-4000	<b>.016</b> 0.41	<b>.154</b> 3.91	Brass	076	1601829-1	P076D16B
18-14 0.80-2.00	<b>.040-.063</b> 1.02-1.60	1600-4000	<b>.016</b> 0.41	<b>.154</b> 3.91	Tin Plated Brass	076	1601658-1	L076D16TB
18-14 0.80-2.00	<b>.040-.063</b> 1.02-1.60	1600-4000	<b>.018</b> 0.46	<b>.154</b> 3.91	Cu Ni	076	1601660-1	L076D18AX
18-14 0.80-2.00	<b>.040-.063</b> 1.02-1.60	1600-4000	<b>.018</b> 0.46	<b>.154</b> 3.91	Brass	076	1601661-1	L076D18B
18-14 0.80-2.00	<b>.040-.063</b> 1.02-1.60	1600-4000	<b>.018</b> 0.46	<b>.154</b> 3.91	Tin Plated Brass	076	1601664-1	L076D18TB
18-14 0.80-2.00	<b>.040-.063</b> 1.02-1.60	1600-4000	<b>.020</b> 0.51	<b>.154</b> 3.91	Brass	076	1601665-1	L076D20B
18-14 0.80-2.00	<b>.040-.063</b> 1.02-1.60	1600-4000	<b>.020</b> 0.51	<b>.154</b> 3.91		076	1601667-1	L076D20TCRS
18-14 0.80-2.00	<b>.040-.063</b> 1.02-1.60	1600-4000	<b>.024</b> 0.61	<b>.154</b> 3.91	Brass	076	1601668-1	L076D24B

† These part numbers are available upon special request; contact Tyco Electronics Engineering for details.

Crimband

**RTM Crimpband Splices** (Continued)

7 Ridges (Continued)



AWG/ mm <sup>2</sup>	Wire Range Solid Dia.	CMA Range	Stock Thk. (T)	Mat'l Width (W)	Material	Toolset	Part Number	Descriptive X-ref
17½-13 0.95-2.54	.042-.068 1.07-1.80	1800-4600	.016 0.41	.154 3.91	Brass	076/092	1601642-1	L076/ 092D16BX
16½-13 1.10-2.60	.047-.072 1.19-1.83	2200-5200	.016 0.41	.154 3.91	Cu Ni	092	1601689-1	L092D16ASP
16½-13 1.10-2.60	.047-.072 1.19-1.83	2200-5200	.016 0.41	.154 3.91	Brass	092	1601691-1	L092D16B
16½-13 1.10-2.60	.047-.072 1.19-1.83	2200-5200	.016 0.41	.154 3.91	Tin Plated Brass	092	1601693-1	L092D16TB
16½-13 1.10-2.60	.047-.072 1.19-1.83	2200-5200	.018 0.46	.154 3.91	Cu Ni	092	1601694-1	L092D18A
16½-13 1.10-2.60	.047-.072 1.19-1.83	2200-5200	.018 0.46	.154 3.91	Brass	092	1601695-1	L092D18B
16½-13 1.10-2.60	.047-.072 1.19-1.83	2200-5200	.018 0.46	.154 3.91	Tin Plated Brass	092	1601841-1	P092D18TB
16½-13 1.10-2.60	.047-.072 1.19-1.83	2200-5200	.020 0.51	.154 3.91	Brass	092	1601528-1†	G092D20B
16-12 1.30-3.46	.051-.078 1.29-1.98	2600-6100	.020 0.51	.154 3.91	Cu Ni	092/125	1601680-1	L092/ 125D20A
16-12 1.30-3.46	.051-.078 1.29-1.98	2600-6100	.020 0.51	.154 3.91	Brass	092/125	1601681-1	L092/ 125D20B
16-12 1.30-3.46	.051-.078 1.29-1.98	2600-6100	.020 0.51	.154 3.91	Tin Plated CRS	092/125	1601682-1	092/ 125D20TCRS
15½-12 1.54-3.46	.055-.082 1.40-2.10	3000-6750	.016 0.41	.154 3.91	Brass	125	1601529-1	G125D16B
15½-12 1.54-3.46	.055-.082 1.40-2.10	3000-6750	.018 0.46	.154 3.91	Cu Ni	125	1601531-1	G125D18A
15½-12 1.54-3.46	.055-.082 1.40-2.10	3000-6750	.018 0.46	.154 3.91	Brass	125	1601726-1	L125D18B
15½-12 1.54-3.46	.055-.082 1.40-2.10	3000-6750	.018 0.46	.154 3.91	Tin Plated Brass	125	1601729-1	L125D18TBX
15½-12 1.54-3.46	.055-.082 1.40-2.10	3000-6750	.020 0.51	.154 3.91	Brass	125	1601730-1	L125D20B
15½-12 1.54-3.46	.055-.082 1.40-2.10	3000-6750	.020 0.51	.154 3.91	Tin Plated Brass	125	1601731-1	L125D20TB
15½-12 1.54-3.46	.055-.082 1.40-2.10	3000-6750	.020 0.51	.154 3.91		125	1601733-1	L125D20TCRS
14½-11½ 1.80-4.00	.059-.087 1.50-2.21	3500-7500	.018 0.46	.154 3.91	Tin Plated Brass	125/165	1601709-1	L125/ 165D18TB
14½-11½ 1.80-4.00	.059-.087 1.50-2.21	3500-7500	.020 0.51	.154 3.91	Cu Ni	125/165	1601710-1	L125/ 165D20A
14½-11½ 1.80-4.00	.059-.087 1.50-2.21	3500-7500	.020 0.51	.154 3.91	Brass	125/165	1601711-1	L125/ 165D20B
14½-11½ 1.80-4.00	.059-.087 1.50-2.21	3500-7500	.020 0.51	.154 3.91	Tin Plated Brass	125/165	1601712-1	L125/ 165D20TB
14-11 2.00-4.20	.063-.092 1.60-2.34	4000-8500	.020 0.51	.154 3.91	Cu Ni	165	1601754-1†	L165D20A
14-11 2.00-4.20	.063-.092 1.60-2.34	4000-8500	.020 0.51	.154 3.91	Brass	165	1601755-1	L165D20B
13½-10½ 2.54-4.50	.071-.097 1.70-2.46	4500-9500	.020 0.51	.154 3.91	Brass	165/200	1601532-1	G165/ 200D20B
11½-9 4.00-6.50	.084-.114 2.13-2.90	7000-13000	.016 0.41	.154 3.91	Brass	200/202	1601764-1	L200/ 202D16B
11½-9 4.00-6.50	.084-.114 2.13-2.90	7000-13000	.020 0.51	.154 3.91	Cu Ni	200/202	1601765-1	L200/ 202D20A
11½-9 4.00-6.50	.084-.114 2.13-2.90	7000-13000	.020 0.51	.154 3.91	Brass	200/202	1601852-1	P200/ 202D20B
11½-9 4.00-6.50	.084-.114 2.13-2.90	7000-13000	.020 0.51	.154 3.91	Tin Plated Brass	200/202	1601766-1	L200/ 202D20TB

† These part numbers are available upon special request; contact Tyco Electronics Engineering for details.

## RTM Crimpband Splices (Continued)

### 6 Ridges

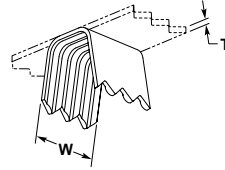

AWG/ mm <sup>2</sup>	Wire Range Solid Dia.	CMA Range	Stock Thk. (T)	Mat'l Width (W)	Material	Toolset	Part Number	Descriptive X-ref
24-20 0.20-0.50	<b>.020-.033</b> 0.51-0.84	400-1100	<b>.012</b> 0.30	<b>.138</b> 3.51	Tin Plated Brass	032/036	1601548-1	L032/ 036C12TB
24-20 0.20-0.50	<b>.020-.033</b> 0.51-0.84	400-1100	<b>.016</b> 0.41	<b>.138</b> 3.51	Brass	032/036	1601549-1	L032/ 036C16B
22-19 0.38-0.60	<b>.024-.036</b> 0.61-0.91	600-1300	<b>.012</b> 0.30	<b>.138</b> 3.51	Brass	045	1601566-1	L045C12B
22-19 0.38-0.60	<b>.024-.036</b> 0.61-0.91	600-1300	<b>.016</b> 0.41	<b>.138</b> 3.51	Cu Ni	045	1601569-1	L045C16A
22-19 0.38-0.60	<b>.024-.036</b> 0.61-0.91	600-1300	<b>.016</b> 0.41	<b>.138</b> 3.51	Brass	045	1601571-1	L045C16B
21-18½ 0.40-0.75	<b>.028-.039</b> 0.71-0.99	800-1500	<b>.012</b> 0.30	<b>.138</b> 3.51	Brass	051	1601808-1†	P051C12B
21-18½ 0.40-0.75	<b>.028-.039</b> 0.71-0.99	800-1500	<b>.016</b> 0.41	<b>.138</b> 3.51	Cu Ni	051	1601809-1	P051C16A
21-18½ 0.40-0.75	<b>.028-.039</b> 0.71-0.99	800-1500	<b>.016</b> 0.41	<b>.138</b> 3.51	Brass	051	1601810-1	P051C16B
21-18½ 0.40-0.75	<b>.028-.039</b> 0.71-0.99	800-1500	<b>.018</b> 0.46	<b>.138</b> 3.51	Brass	051	1601586-1†	L051C18B
20½-16 0.45-1.30	<b>.030-.051</b> 0.76-1.29	900-2600	<b>.016</b> 0.41	<b>.138</b> 3.51	Cu Ni	061	1601614-1	L061C16A
20½-16 0.45-1.30	<b>.030-.051</b> 0.76-1.29	900-2600	<b>.016</b> 0.41	<b>.138</b> 3.51	Brass	061	1601511-1	G061C16B
20½-16 0.45-1.30	<b>.030-.051</b> 0.76-1.29	900-2600	<b>.016</b> 0.41	<b>.138</b> 3.51	Tin Plated Brass	061	1601617-1	L061C16TB
20½-16 0.45-1.30	<b>.030-.051</b> 0.76-1.29	900-2600	<b>.018</b> 0.46	<b>.138</b> 3.51	Cu Ni	061	1601618-1	L061C18AX
20½-16 0.45-1.30	<b>.030-.051</b> 0.76-1.29	900-2600	<b>.018</b> 0.46	<b>.138</b> 3.51	Brass	061	1601619-1	L061C18B
20½-16 0.45-1.30	<b>.030-.051</b> 0.76-1.29	900-2600	<b>.020</b> 0.51	<b>.138</b> 3.51	Brass	061	1601513-1†	G061C20B
20-15 0.60-1.60	<b>.033-.057</b> 0.84-1.45	1100-3200	<b>.016</b> 0.41	<b>.138</b> 3.51	Brass	061/076	1601597-1	L061/ 076C16B
20-15 0.60-1.60	<b>.033-.057</b> 0.84-1.45	1100-3200	<b>.016</b> 0.41	<b>.138</b> 3.51	Tin Plated Brass	061/076	1601599-1	L061/ 076C16TB
20-15 0.60-1.60	<b>.033-.057</b> 0.84-1.45	1100-3200	<b>.018</b> 0.46	<b>.138</b> 3.51	Brass	061/076	1601600-1†	L061/ 076C18B
18-14 0.80-2.00	<b>.040-.063</b> 1.02-1.60	1600-4000	<b>.016</b> 0.41	<b>.138</b> 3.51	Cu Ni	076	1601650-1	L076C16A
18-14 0.80-2.00	<b>.040-.063</b> 1.02-1.60	1600-4000	<b>.016</b> 0.41	<b>.138</b> 3.51	Brass	076	1601651-1	L076C16B
18-14 0.80-2.00	<b>.040-.063</b> 1.02-1.60	1600-4000	<b>.018</b> 0.46	<b>.138</b> 3.51	Cu Ni	076	1601652-1†	L076C18A
18-14 0.80-2.00	<b>.040-.063</b> 1.02-1.60	1600-4000	<b>.018</b> 0.46	<b>.138</b> 3.51	Brass	076	1601827-1	P076C18B
18-14 0.80-2.00	<b>.040-.063</b> 1.02-1.60	1600-4000	<b>.018</b> 0.46	<b>.138</b> 3.51		076	1601654-1†	L076C18TCRS
17½-13 0.95-2.54	<b>.042-.068</b> 1.07-1.80	1800-4600	<b>.016</b> 0.41	<b>.138</b> 3.51	Brass	076/092	1601640-1	L076/ 092C16B
16½-13 1.10-2.60	<b>.047-.072</b> 1.19-1.83	2200-5200	<b>.016</b> 0.41	<b>.138</b> 3.51	Cu Ni	092	1601837-1	P092C16AX
16½-13 1.10-2.60	<b>.047-.072</b> 1.19-1.83	2200-5200	<b>.016</b> 0.41	<b>.138</b> 3.51	Brass	092	1601687-1	L092C16B
15½-12 1.54-3.46	<b>.055-.082</b> 1.40-2.10	3000-6750	<b>.016</b> 0.41	<b>.138</b> 3.51	Tin Plated Brass	125	1601721-1	L125C16TB
15½-12 1.54-3.46	<b>.055-.082</b> 1.40-2.10	3000-6750	<b>.018</b> 0.46	<b>.138</b> 3.51	Cu Ni	125	1601722-1	L125C18A
15½-12 1.54-3.46	<b>.055-.082</b> 1.40-2.10	3000-6750	<b>.018</b> 0.46	<b>.138</b> 3.51	Brass	125	1601723-1	L125C18B

† These part numbers are available upon special request; contact Tyco Electronics Engineering for details.

Crimband

### RTM Crimpband Splices (Continued)

#### 3 Ridges

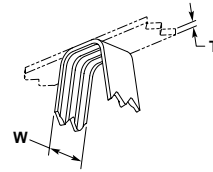

AWG/ mm <sup>2</sup>	Wire Range Solid Dia.	CMA Range	Stock Thk. (T)	Mat'l Width (W)	Material	Toolset	Part Number	Descriptive X-ref
27½-21 0.09-0.40	.013-.028 0.33-0.71	170-800	.012 0.30	.076 1.93	Brass	032	1601555-1	L032B12B
24-20 0.20-0.50	.020-.033 0.51-0.84	400-1100	.012 0.30	.076 1.93	Cu Ni	032/036	1601542-1	L032/ 036B12A
24-20 0.20-0.50	.020-.033 0.51-0.84	400-1100	.012 0.30	.076 1.93	Brass	032/036	1601795-1	P032/ 036B12B
24-20 0.20-0.50	.020-.033 0.51-0.84	400-1100	.016 0.41	.076 1.93	Brass	032/036	1601545-1	L032/ 036B16B
24-20 0.20-0.50	.020-.033 0.51-0.84	400-1100	.016 0.41	.076 1.93	Tin Plated Brass	032/036	1601546-1	L032/ 036B16TB
24-20 0.20-0.50	.020-.033 0.51-0.84	400-1100	.018 0.46	.076 1.93	Brass	032/036	1601547-1†	L032/ 036B18B
22-19 0.38-0.60	.024-.036 0.61-0.91	600-1300	.016 0.41	.076 1.93	Cu Ni	045	1601503-1	G045B16A
22-19 0.38-0.60	.024-.036 0.61-0.91	600-1300	.016 0.41	.076 1.93	Brass	045	1601562-1	L045B16B
22-19 0.38-0.60	.024-.036 0.61-0.91	600-1300	.016 0.41	.076 1.93	Tin Plated Brass	045	1601504-1†	G045B16TB
22-19 0.38-0.60	.024-.036 0.61-0.91	600-1300	.016 0.41	.076 1.93	Tin Plated Brass	045	1601564-1	L045B16TBSP
21-18½ 0.40-0.75	.028-.039 0.71-0.99	800-1500	.016 0.41	.076 1.93	Cu Ni	051	1601580-1†	L051B16A
21-18½ 0.40-0.75	.028-.039 0.71-0.99	800-1500	.016 0.41	.076 1.93	Brass	051	1601582-1†	L051B16B
21-18½ 0.40-0.75	.028-.039 0.71-0.99	800-1500	.016 0.41	.076 1.93	Tin Plated Brass	045	1601583-1†	L051B16TB
21-18½ 0.40-0.75	.028-.039 0.71-0.99	800-1500	.020 0.51	.076 1.93	Brass	051	1601584-1	L051B20B
20½-16 0.45-1.30	.030-.051 0.76-1.29	900-2600	.016 0.41	.076 1.93	Tin Plated Brass	061	1601612-1†	L061B16TB
20½-16 0.45-1.30	.030-.051 0.76-1.29	900-2600	.016 0.41	.076 1.93	Cu Ni	061	1601610-1	L061B16A
20½-16 0.45-1.30	.030-.051 0.76-1.29	900-2600	.016 0.41	.076 1.93	Brass	061	1601611-1	L061B16B
20½-16 0.45-1.30	.030-.051 0.76-1.29	900-2600	.016 0.41	.076 1.93	Brass	061	1601635-1	L061L16B
20-15 0.60-1.60	.033-.057 0.84-1.45	1100-3200	.016 0.41	.076 1.93	Tin Plated Brass	061/076	1601596-1	L061/ 076B16TBX
18-14 0.80-2.00	.040-.063 1.02-1.60	1600-4000	.016 0.41	.076 1.93	Brass	076	1601825-1	P076B16B
18-14 0.80-2.00	.040-.063 1.02-1.60	1600-4000	.020 0.51	.076 1.93	Brass	076	1601649-1	L076B20B

† These part numbers are available upon special request; contact Tyco Electronics Engineering for details.



**Crimband Application Tooling**

**Product Facts**

- **High Speed Operation** — Many times faster than soldering, up to 2,000 crimps per hour
- **Reliable** — Creates uniform connection, unlike soldering
- **Dependable** — The connection is stronger than the wires being crimped
- **Clean** — No heat or noxious solder fumes
- **Scrap Free** — No leftover scrap material
- **Easy Operation** — Simple operator training
- **Economical** — Proven reduction in assembly costs

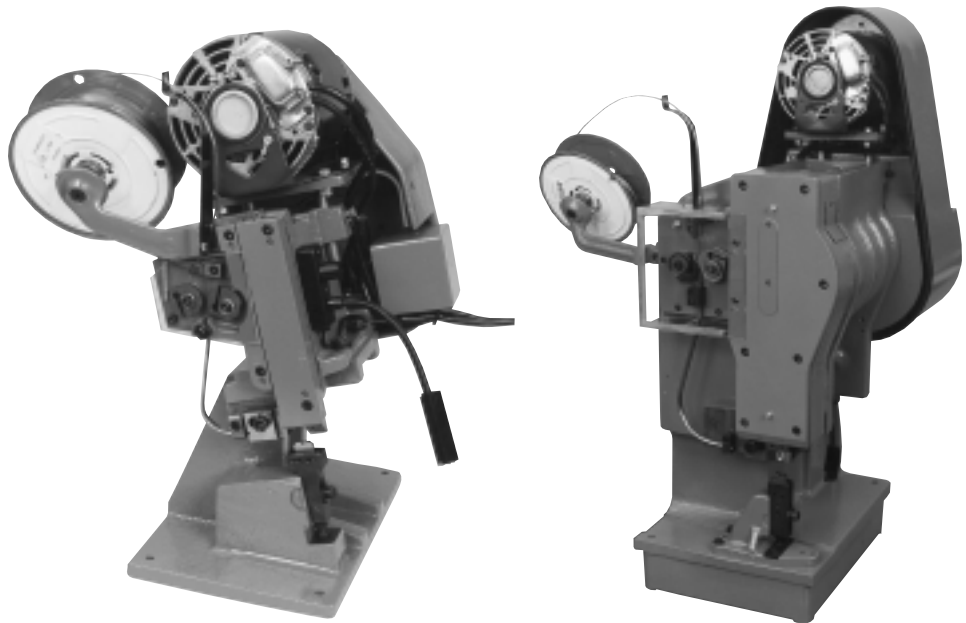

**Mod I**

**Mod III**

Tyco Electronics offers solderless crimping systems to handle a wide range of wire connections including solid and stranded lead wire, insulated magnet wire, and component leads. Each system is comprised of continuous, serrated Crimband material and a crimping machine. The Tyco Electronics solution allows the flexibility to create a shape and size, which optimizes the crimp's electrical and mechanical performance.

The Tyco Electronics crimping system produces a very economical and reliable interconnection. Utilizing a continuous Crimband material the machine will feed, cut form, and crimp your application resulting in a very strong and uniform interconnect crimp.

Whether your application required a wire-to-wire, wire to component leads, wire to terminals, or magnet wire splice termination, the very flexible and dependable crimping machine will provide high-speed scrap free interconnects.

Substantial increase in production interconnection rates can be realized versus traditional soldering. Not to mention it completely eliminates the noxious fumes.

The Mod I crimping system is used when running standard RTM and MTM Crimband product. In addition, left and right horn

termination machines are available when your application requires additional working envelope. The Mod III crimping system is used when stainless steel splices or when large wire gauge applications warrant additional force requirements.

**Tooling and Equipment Selector**

Volume To Be Crimped	Recommended Equipment		
	CMA	in <sup>2</sup> /mm <sup>2</sup>	Toolset Size
140-800	<b>.003-.016</b> 0.07 - 0.40	032	Mod I
400-1200	<b>.008-.024</b> 0.20 - 0.60	032/036	Mod I
600-1600	<b>.012-.032</b> 0.30 - 0.81	045	Mod I
900-2600	<b>.018-.052</b> 0.45 - 1.31	061	Mod I
1600-4000	<b>.032-.080</b> 0.81 - 2.02	076	Mod I
2200-5200	<b>.044-.104</b> 1.11 - 2.63	092	Mod I
3000-6750	<b>.060-.135</b> 1.52 - 3.42	125	Mod I
4000-8500	<b>.080-.170</b> 2.02 - 4.31	165	Mod III
5000-11000	<b>.010-.219</b> 2.53 - 5.57	200	Mod III
6000-13000	<b>.120-.259</b> 3.04 - 6.58	200/202	Mod III

1. Calculate the combined volume of the wires or components in a crimp.
2. Select Tooling and Machine.
3. Submit samples for test and equipment conditioning.
4. Toolsets are easily interchangeable within same machine type.

Crimband

Dimensions are in inches and millimeters unless otherwise specified. Values in brackets are metric equivalents.

Dimensions are shown for reference purposes only. Specifications subject to change.

Technical Support  
USA: 1-800-522-6752  
Canada: 1-905-475-6222  
Mexico: 01-800-733-8926

www.tycoelectronics.com

## COPALUM Terminals and Splices (For Solid and Stranded Aluminum or Copper Wire)

### Product Facts

- COPALUM terminates film insulated solid aluminum, film insulated solid copper, or uninsulated stranded copper conductors — individually or in combination
- Round wire — up to 10 wires can be terminated in a single terminal or splice
- Stripping of film insulated solid conductors not required when the insulation piercing technique/tooling are utilized
- Eliminates messy inhibitors
- Available for a broad range of wire sizes — from 16 to 4/0 AWG [1.25 to 105 mm<sup>2</sup>]
- Provides stable electrical and mechanical performance in a low-cost reliable termination



### Applications

- Transformers
- Coil windings
- Motors
- Regulators

COPALUM terminals and splices provide reliable, low cost terminations for film insulated solid aluminum, film insulated solid copper, or uninsulated stranded copper conductors.

Stranded solid, round and rectangular conductors can be terminated in the same wire barrel, individually or in combinations falling within a specified CMA range.

The combination of an insulation displacement crimp configuration and an integral perforated inner sleeve design penetrates the film insulation, creating an elec-

trical interface between the conductor and terminal. Adequate surface contact is achieved due to the high-density hole pattern of the sleeve.

The crimp shears the film insulation and the conductor extrudes into the perforated sleeve, producing a hermetic seal. These terminations can be exposed to the typical gaseous and oil environments found in oil and air-cooled transformers or air and fluid-cooled motors.

A secondary mechanical crimp section flanks the

electrical crimp and provides a robust interface which optimizes the mechanical properties (tensile strength, vibration, resistance, flex life) of the electrical crimp. The insulation piercing crimp design permits parallel, butt or pigtail splicing.

The crimp design allows solid copper, solid aluminum and stranded copper to be terminated in the same wire barrel if certain restrictions regarding size, number and total CMA of conductors being terminated are observed.

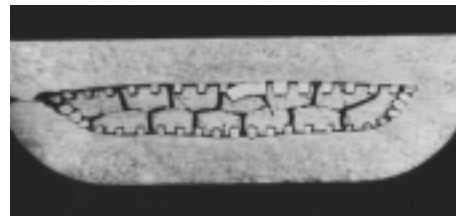

**Cross Section of  
Insulation Piercing Crimp**

**COPALUM Terminals and Splices**  
**(For Solid and Stranded Aluminum or Copper Wire)** (Continued)

**General Application Guidelines**

To assist you in obtaining the optimum COPALUM insulation piercing crimp termination for solid copper, solid aluminum and stranded copper in the same wire barrel, the following guidelines regarding size, number and total CMA of conductors being terminated are recommended:

1. A maximum of 10 equal size round wires, or a maximum of 6 equal square wires may be crimped without insulation removal.
2. Four rectangular wires (where  $T \geq 1/4W$ ) or 2 rectangular wires (where  $T \leq 1/4W$ ) may be crimped without insulation removal.
3. When crimping different size solid conductors, size should not vary by more than 1 wire gauge, and preferably by no more than 1/2 wire gauge.
4. To use parallel splices with round magnet wire, the CMA of the lead wire should be less than the sum of the magnet wire CMA, and the total number of conductors (lead and magnet) must be less than six.
5. To use a butt splice when the lead wire CMA is  $\geq$  the combined magnet wire CMA.
6. In a solid (or combination of solids) aluminum and stranded copper application, the maximum amount of CMA fill for the copper conductor should not exceed 40% of the total CMA being crimped.
7. Due to the closed barrel, it may not be possible for a particular CMA loading to fit in the normally recommended connector. In instances where 7 or more equal round conductors or a combination of solid aluminum and stranded copper is used, and the total CMA is at least 50% of the maximum CMA of the next larger size connector, this larger size connector may be used.
8. For applications using wire combinations not covered by guidelines above, consult Tyco Electronics Engineering.

**Warning:** Not approved for reconnection of residential aluminum branch circuit wiring. (Refer to Catalog 82205.)

**Test Results of Insulation Piercing Crimp Terminations**

**Current Cycling** — 100 cycles @ 35 amperes, AC; each cycle consisting of 15 min. "on current" and 15 min. "off current"

**Thermal Shock** — 0.5 hr. @ +150°C and 0.17 hr. in ice water per cycle; 5 amperes, DC

**Products Tested** — COPALUM parallel splices, wire size 8 AWG [8 mm<sup>2</sup>] using two 14 AWG [2 mm<sup>2</sup>] solid aluminum conductors (unstripped) and one 14 AWG [2 mm<sup>2</sup>] stranded copper wire

conductor (stripped). Graph curves represent individual conductor readings.



**Technical Documents**

**Product Specification** — 108-13013

**Application Specification** — 114-02121

**Test Reports** —

110-13506 — Copper lead wire to aluminum magnet wire in a COPALUM parallel splice

502-1084 — COPALUM butt splice performance in several copper lead wire to copper magnet wire combinations

502-1085 — Performance comparison: COPALUM butt splice vs. brazing process

COPALUM

**COPALUM Terminals and Splices**  
**(For Solid and Stranded Aluminum or Copper Wire)** (Continued)

**Butt Splices**

Wire Size Range —  
Aluminum — AWG 16 to 10  
[1.25 to 5.0 mm<sup>2</sup>], CMA 2,050 to 13,100  
Copper — AWG 18 to 12  
[0.8 to 3 mm<sup>2</sup>], CMA 1,290 to 8,230



Wire Size [mm <sup>2</sup> ] Circular Mils		Dim. L Max.	Hand Tool	Part Numbers		Splice
Aluminum	Copper			Heads for Pneumatic Tools		
				626 Tooling	68068	
16-14 [1.25] 2050-5180	18-16 [0.8] 1290-3260	.701 17.81	68140-1	189447-1	68100	52001
12-10 [5.0] 5180-13100	14-12 [3.0] 3260-8230	.799 20.29	68141-1	189444-1	68100 68101	52004

Wire Size Range —  
Aluminum — AWG 8 to 4/0  
[8.0 to 105 mm<sup>2</sup>], CMA 13,100 to 231,000  
Copper — AWG 12 to 3/0  
[5.0 to 85 mm<sup>2</sup>], CMA 5,180 to 190,000



Wire Size [mm <sup>2</sup> ] Circular Mils		Dim. L Max.	Part Numbers				Splice	
Aluminum	Copper		Heads for Pneumatic Tools		Tooling for Power Unit 69120			
			626 Tooling	69015	68068	Head	Die Insert	
8 [8.0] 13100-20800	12-10 [5.0] 5180-13100	1.195 30.35	662546-1	68081	68101 68192-1	69099	68084	51826
6 [14] 20800-33100	8 [8.0] 13100-20800	1.340 34.04	—	68082	68102	69099	68085	51941
4 [21] 33100-52600	6 [14] 20800-33100	1.630 41.4	—	68038	—	69099	68086	51942
2 [35] 52600-83700	4 [21] 33100-52600	1.995 50.67	—	—	—	69099	68130	52007
1/0 [50] 83700-119500	2 [35] 52600-83700	1.985 50.42	—	—	—	69099	68131	52010
2/0 [70] 119500-150500	1/0 [50] 83700-119500	1.985 50.42	—	—	—	69099	68132	52013
3/0 [85] 150500-190000	2/0 [70] 119500-150500	1.985 50.42	—	—	—	69099	68133	52016
4/0 [105] 190000-231000	3/0 [85] 150500-190000	1.985 50.42	—	—	—	69082	68129	52019

**COPALUM Terminals and Splices**  
**(For Solid and Stranded Aluminum or Copper Wire)** (Continued)

**Parallel Splices**

Wire Size Range —

Aluminum — AWG 16 to 4/0  
[1.25 to 105 mm<sup>2</sup>], CMA 2,050  
to 231,000

Copper — AWG 18 to 3/0  
[0.8 to 85 mm<sup>2</sup>], CMA 1,290 to  
190,000

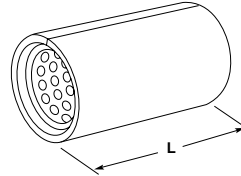

Wire Size [mm <sup>2</sup> ] Circular Mills	Dim. L Max.	Hand Tool	Part Numbers					Splice
			Heads for Pneumatic Tools			Tooling for Power Unit 69120		
			69015	626 Tooling	68068	Head	Die Insert	
16-14 [1.25] 2050-5180	.283 7.19	68140-1	—	189447-1	68100	—	—	52791
12-10 [5.0] 5180-13100	.375 9.53	68141-1	—	189444-1	68100 68101	—	—	52792
8 [8.0] 13100-20800	.437 11.1	—	68081	662546-1	68101 68192-1	69099	68084	52745
6 [14] 20800-33100	.450 11.43	—	68082	—	68102	69099	68085	52746
4 [21] 33100-52600	.562 14.27	—	68038	—	—	69099	68086	52747
2 [35] 52600-83700	.781 19.84	—	—	—	—	69099	68130	52748
1/0 [50] 83700-119500	.734 18.64	—	—	—	—	69099	68131	52749
2/0 [70] 11950-150500	.734 18.64	—	—	—	—	69099	68132	52750
3/0 [85] 150500-190000	.749 19.02	—	—	—	—	69099	68133	52751
4/0 [105] 190000-231000	.765 19.43	—	—	—	—	69082	68129	52752

**Important:**

When two or more wires are used in a parallel splice, the combined cross-section area must be within the CMA range listed.

COPALUM

**COPALUM Terminals and Splices**  
**(For Solid and Stranded Aluminum or Copper Wire)** (Continued)

**Ring Tongue Terminals**

Wire Size Range —  
Aluminum — AWG 16 to 10  
[1.25 to 5.0 mm<sup>2</sup>], CMA 2,050  
to 13,100  
Copper — AWG 18 to 12  
[0.8 to 3.0 mm<sup>2</sup>], CMA 1,290  
to 8,230



Wire Size [mm <sup>2</sup> ] Circular Mils	Tongue Thickness Max.	Stud Size	Dimensions				Hand Tool	Part Numbers		Terminal
			W	L Max.	E Max.	C Min.		Heads for Pneumatic Tools		
							626 Tooling		68068	
16-14 [1.25] 2050-5180	.033 0.84	1/4	.531	1.107	.839	.564	68140-1	189447-1	68100	52587-1
		M6	13.49	28.12	21.31	14.33				
		6	.375	.835	.645	.302				
12-10 [5.0] 5180-13100	.042 1.07	M3.5	9.53	21.21	16.38	7.67	68141-1	189444-1	68100 68101	51979
		8	.375	.835	.645	.302	68141-1	189444-1	68100 68101	51979-1
		M4	9.53	21.21	16.38	7.67	68141-1	189444-1	68100 68101	51979-2
		10	.375	.835	.645	.302	68141-1	189444-1	68100 68101	51979-3
		1/4	.375	.835	.645	.302	68141-1	189444-1	68100 68101	51979-3
		M6	9.53	21.21	16.38	7.67	68141-1	189444-1	68100 68101	52590-1
1/4	.042	M6	15.06	29.79	22.20	13.49	68141-1	189444-1	68100 68101	52590-1
		5/16	.593	1.173	.874	.531	68141-1	189444-1	68100 68101	52590-2
		M8	15.06	29.79	22.20	13.49	68141-1	189444-1	68100 68101	52590-2

Wire Size Range —  
Aluminum — AWG 8 to 6  
[8.0 to 14 mm<sup>2</sup>], CMA 13,100  
to 33,100  
Copper — AWG 12 to 8  
[3.0 to 8.0 mm<sup>2</sup>], CMA 1,290  
to 13,100



Wire Size [mm <sup>2</sup> ] Circular Mils	Tongue Thickness Max.	Stud Size	Dimensions				Part Numbers			Terminal		
			W	L Max.	E Max.	R Max.	Heads for Pneumatic Tools		Heads & Die Inserts for Power Unit 69120			
							626 Tooling	69015	68068	Head	Die Insert	
8 [8.0] 13100-20800	.048 1.22	10	.500	1.384	1.131	.560	662546-1	68081	68101 68192-1	69099	68084	50720
		1/4	.500	1.384	1.131	.560						
		M6	12.70	35.15	28.73	14.22						
		5/16	.625	1.446	1.131	.560						
6 [14] 20800-33100	.051 1.30	M8	15.88	36.73	28.73	14.22	662546-1	68081	68101 68192-1	69099	68084	184076-1
		10MM	.625	1.446	1.131	.560	662546-1	68081	68101 68192-1	69099	68084	184076-1
		10	.500	1.415	1.162	.580	—	68082	68102	69099	68085	50719
		1/4	.500	1.415	1.162	.580	—	68082	68102	69099	68085	50719-1
		M6	12.70	35.94	29.51	14.73	—	68082	68102	69099	68085	50719-2
		5/16	.679	1.504	1.162	.580	—	68082	68102	69099	68085	50719-3
3/8	.679	1.504	1.162	.580	—	68082	68102	69099	68085	50719-3		
10MM	.679	1.504	1.162	.580	—	68082	68102	69099	68085	184079-1		

**COPALUM Terminals and Splices**  
(For Solid and Stranded Aluminum or Copper Wire) (Continued)

Ring Tongue Terminals

Wire Size Range —

Aluminum — AWG 4 to 4/0  
[21 to 105 mm<sup>2</sup>], CMA 33,100 to 231,000

Copper — AWG 6 to 3/0  
[14 to 85 mm<sup>2</sup>], CMA 20,800 to 190,000



Wire Size [mm <sup>2</sup> ] Circular Mils	Tongue Thickness Max.	Stud Size	Dimensions				Part Numbers		Terminal
			W	L Max.	E Max.	R Max.	Heads & Die Inserts for Power Unit 69120		
							Head	Die Insert	
4 [21] 33100-52600	.060 1.52	10 —	.531 13.49	1.630 41.40	1.362 34.59	.625 15.88	69099	68086	50717
		1/4 M6	.531 13.49	1.630 41.40	1.362 34.59	.625 15.8	69099	68086	50717-1
		5/16 M8	.531 13.49	1.630 41.40	1.362 34.59	.62 15.88	69099	68086	50717-2
		3/8 —	.675 17.15	1.702 43.23	1.362 34.59	.625 15.88	69099	68086	50717-3
		1/2 —	.675 17.15	1.702 43.23	1.362 34.59	.625 15.88	69099	68086	50717-5
		10MM —	.675 17.15	1.702 43.23	1.362 34.59	.625 15.88	69099	68086	184082-1
		2 [35] 52600-83700	.060 1.52	1/4 M6	.675 17.15	1.859 47.22	1.541 39.14	.625 15.88	69099
5/16 M8	.675 17.15			1.859 47.22	1.541 39.14	.625 15.88	69099	68130	51982-1
3/8 —	.675 17.15			1.859 47.22	1.541 39.14	.625 15.88	69099	68130	51982-2
1/2 —	.807 20.50			1.925 48.90	1.541 39.14	.625 15.88	69099	68130	51982-3
10MM —	.807 20.50			1.925 48.90	1.541 39.14	.625 15.88	69099	68130	184084-1
1/0 [50] 83700-119500	.073 1.85	1/4 M6	.675 17.15	1.859 47.22	1.541 39.14	.625 15.88	69099	68131	51986
		5/16 M8	.675 17.15	1.859 47.22	1.541 39.14	.625 15.88	69099	68131	51986-1
		3/8 —	.675 17.15	1.859 47.22	1.541 39.14	.625 15.88	69099	68131	51986-2
		1/2 —	.807 20.50	1.925 48.90	1.541 39.14	.625 15.88	69099	68131	51986-3
		10MM —	.807 20.50	1.925 48.90	1.541 39.14	.625 15.88	69099	68131	184087-1
2/0 [70] 119500-150500	.083 2.11	5/16 M8	.926 23.52	1.930 49.02	1.560 39.62	.625 15.88	69099	68132	51989-1
		3/8 —	.926 23.52	1.930 49.02	1.560 39.62	.625 15.88	69099	68132	51989-2
		1/2 —	.926 23.52	1.930 49.02	1.560 39.62	.625 15.88	69099	68132	51989-3
		10MM —	.926 23.52	1.930 49.02	1.560 39.62	.625 15.88	69099	68132	184090-1
3/0 [85] 150500-190000	.094 2.39	7/16 —	1.020 25.91	2.112 53.64	1.645 41.66	.625 15.88	69099	68133	51992-2
		1/2 —	1.020 25.91	2.112 53.64	1.645 41.66	.625 15.88	69099	68133	51992-3
		10MM —	1.020 25.91	2.112 53.64	1.645 41.66	.625 15.88	69099	68133	184092-1
4/0 [105] 190000-231000	.105 2.67	1/2 —	1.087 27.61	2.178 55.32	1.676 42.57	.625 15.88	69082	68129	51995-2
		10MM —	1.087 27.61	2.178 55.32	1.676 42.57	.625 15.88	69082	68129	184094-1

COPALUM

Dimensions are in inches and millimeters unless otherwise specified. Values in brackets are metric equivalents.

Dimensions are shown for reference purposes only. Specifications subject to change.

Technical Support  
USA: 1-800-522-6752  
Canada: 1-905-475-6222  
Mexico: 01-800-733-8926

www.tycoelectronics.com

**COPALUM Application Tooling**

**626 Pneumatic Tool System**

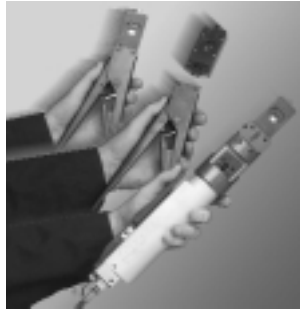

Lightweight, air-operated modular tooling system. Accepts a wide variety of interchangeable heads for crimping various types of contacts, terminals and splices onto wires ranging 6-26 AWG [13-0.12 mm<sup>2</sup>], plus coaxial and fiber optic cable. Available with either hand- or foot-actuation switch. Optional ratchet control available to provide complete crimp cycle.

**Specifications**

**Outside Diameter**—1.83 [46.5]  
**Length**—11.6-12.9 [295-327]  
**Grip Span**—2.19 [55.6] over button/handle  
**Weight**—2.3-3.3 lb [1.0-1.5 kg]  
**Air**—90-100 psi [6.21-6.89 bar], 11.14 in<sup>3</sup> [0.00018 m<sup>3</sup>]  
**Cycle Time**—0.7-0.8 sec (16-14 AWG [1.3-2 mm<sup>2</sup>] PIDG Terminals)  
 For more information, request Catalog **124208**.

**Power Unit**

Style	Power Unit Part Number
Hand Actuated	189721-1*
Foot Actuated	189722-1*

\*Change to -2 suffix to order Power Unit for use with "C" Head die set adapter.

**Notes:**

1. Power Units with a '1' suffix can be converted to -2 by ordering Booster Addition Kit part no. 189720-1
2. 10 ft [3.05] Air Supply Hose, part no. 38111, is included with each power unit
3. Order Tool Holders, Crimping Heads/Adapters separately.

**Tool Holder**

w/Ratchet Control	w/o Ratchet Control
356302-1	189767-1

**Crimp Heads**

AWG	Part Number
16-14	189447-1
12-10	189444-1
8	602546-1

**Bench Mount Assembly  
Part Number 856402-1\***



Fully adjustable stand allows operator free use of both hands — recommended for maximum productivity.

**Specifications**

**Base Size** — 8 x 8 [200 x 200]  
**Weight** — 6.5 lb [2.9 kg]  
**Bench Mounting Dimensions** — Base has two, 1/4 - 20 tapped holes on 6 [150] centerlines

\*Note: Not for use in the European Community



**COPALUM Application Tooling** (Continued)

**DYNA-CRIMP Electric-Hydraulic Power Units, 69120-1, -2, plus Heads**



Power units for crimping large terminals and splices, including AMPOWER and SOLISTRAND terminals, onto wires ranging from 8 AWG [8 mm<sup>2</sup>] through 1 000 kcmil [507 mm<sup>2</sup>]. Heads and die sets are interchangeable. Available with either hand- or foot-actuation switch, and hose/coupling assemblies up to 28 ft [8.5 m] in length.

**Specifications**

**Width**—9.5 [240]  
**Depth**—11.5 [292]  
**Height**—18.2 [464]  
**Weight**—65 lb [29 kg]  
**Electrical**—120 VAC, 60 Hz (69120-1); 220 VAC, 50 or 60 Hz (69120-2); 3 240 VA max.  
 For more information, request Instruction Sheet **408-1965**.

**Accessories for DYNA-CRIMP Power Units 69120-1 (115 V) or 69120-2 (230 V)**

Accessory Part No.	Description
59907-7	7 ft. [2.13m] Handle Control Assembly — Hose and Cord*
1-59907-5	15 ft. [4.57m] Handle Control Assembly — Hose and Cord*
2-59907-1	21 ft. [6.4m] Handle Control Assembly — Hose and Cord*
2-59908-1	21 ft. [6.4 m] Handle Control Assembly — Cord w/o Hose*
2-59907-8	28 ft [8.53m] Handle Control Assembly — Hose and Cord*
68284-1	15 ft. [4.57m] Foot Switch Assembly (requires hose assembly)
59909-3	3 ft [0.91m] Hose Assembly**
59909-7	7 ft. [2.13m] Hose Assembly**
1-59909-5	15 ft. [4.57m] Hose Assembly**
2-59909-1	21 ft. [6.4m] Hose Assembly**
59220	3-Way Multi-Directional Valve (for use with foot switch only)
59220-2	3-Way Multi-directional valve (for use with foot switch only)

\* Pressure release on Power Unit only

\*\* 311470-1 Quick Disconnect Coupling (Hose Half) and 68284-1 Foot Switch Assembly required

**Pneumatic Power Units, 68068, 69015**



Designed for medium production, these semi-automatic power tools offer the convenience of hand tools plus the effortless precision and speed of machines. They are built for long, rugged service and are equipped with removable crimping dies for terminating a variety of AMP products.

**Wire range:** — 16 AWG to 6 AWG (68068), 8 AWG to 4 AWG (69015)  
**CMA range:** — 2,050 to 33,100 (68068), 20,800 to 52,600 (69015)  
 Note: Part Number 68068-3, tool with foot pedal, can be bench mounted.

**COPALUM**

## Power Splice

### Product Facts

- Compression crimp eliminates cold solder points, weld burns and wire embrittlement usually connected with thermal-type terminations
- Precisely controlled crimp termination helps eliminate human error, for maximum reliability
- Excellent tensile strength, up to 90 lbs axial retention, vibration resistant
- Provides a superior electrical connection that is free of many contaminants such as stripper residue and solder flux
- 8000 - 38,000 CMA nominal capacity
- Accepts up to six magnet wires and two standard solid or stranded lead wires
- Superior test results: low resistance, high stability
- High termination rates, low wire consumption and the elimination of rejects caused by solder flux or heat damage results in the lowest applied costs

### Applications

- Hermetic/Compressor motors
- Squirrel Cage DC motors
- Capacitor Start motors
- Gear & Traction motors
- Power supplies
- Liner, Torroid & RF transformers
- Circuit breakers & welders



Tyco Electronics features the AMP Power Splice terminal that is specifically designed to terminate a wide range of lead and magnet wire combinations.

The splice contains two cavities that separate and cradle magnet wire and stripped lead wires prior to crimping.

The outer saddle accepts up to six-magnet wire allowing for a CMA range of 15,000 to 30,000.

The inner saddle accepts pre-stripped lead wires that total up to 10,900 CMA.

In a one step automatic operation, the magnet wire film insulation is multiple ring-stripped as it is forced into the serrations while the lead wire is simultaneously terminated during the precisely controlled crimp

The outer saddle has machined, sharp edges made by a special production process that pierces the insulating layer of the magnet wire in a manner that provides a large contact area.

The resulting termination produces a high tensile strength, air sealed connection that is as resistant to corrosion as the insulated conductor with up to 90 lbs axial retention.

As many as six magnet wires can be terminated simultaneously in one splice in combination with up to two pre-stripped standard solid or stranded lead wire.

A semi-automatic machine provides high output per hour terminations.



## Technical Information

### Tensile Strength of Magnet Wire<sup>1</sup>

Wire Size	Nominal Dia. Copper (lbs.)	Nominal Dia. Aluminum (lbs.)
8	438	142
9	340	113
10	269	89
11	213	71
12	189	56
13	134	44
14	106	35
15	84	28
16	66	22
17	53	17
18	42	14
19	33	11
20	6	8
21	21	7
22	16	5
23	13	4
24	10	3
25	8	2.7
26	6	2.1
27	5	1.7
28	4	1.3
29	3	1.1
30	2	.86
31	2	.68
32	1	.55
33	1	.43
34	1	.34
35	.81	.27
36	.65	.21
37	.65	.21
38	.42	.13
39	.32	.10
40	.25	.083
41	.20	.067
42	.16	.054
43	.12	.041
44	.10	.034
45	.08	.027
46	.06	.022
47	.05	.017
48	.04	.013
49	.03	.010
50	.02	.009
51	.02	.007
52	.01	.005

C.	F.	C.	F.	C.	F.	C.	F.
-80	-112.0	9	48.2	47	116.6	85	185.0
-70	-94.0	10	50.0	48	118.4	86	186.8
-60	-76.0	11	51.8	49	120.2	87	188.6
-50	-58.0	12	53.6	50	122.0	88	190.4
-45	-49.1	13	55.4	51	123.8	89	192.2
-40	-40.0	14	57.2	52	125.6	90	194.0
-35	-31.0	15	59.0	53	127.4	91	195.8
-30	-22.0	16	60.8	54	129.2	92	197.6
-25	-13.0	17	62.6	55	131.0	93	199.4
-20	- 4.0	18	64.4	56	132.8	94	201.2
-19	- 2.2	19	66.2	57	134.6	95	203.0
-18	- .4	20	68.0	58	136.4	96	204.8
-17	1.4	21	69.8	59	138.2	97	206.6
-16	3.2	22	71.6	60	140.0	98	208.4
-15	5.0	23	73.4	61	141.8	99	210.2
-14	6.8	24	75.2	62	143.6	100	212.0
-13	8.6	25	77.0	63	145.4	110	230.0
-12	10.4	26	78.8	64	147.2	120	248.0
-11	12.2	27	80.6	65	149.0	130	266.0
-10	14.0	28	82.4	66	150.8	140	284.0
- 9	15.8	29	84.2	67	152.6	150	302.0
- 8	17.6	30	86.0	68	154.4	160	320.0
- 7	19.4	31	87.8	69	156.2	170	338.0
- 6	21.2	32	89.6	70	158.0	180	356.0
- 5	23.0	33	91.4	71	159.8	190	374.0
- 4	24.8	34	93.2	72	161.6	200	392.0
- 3	26.6	35	95.0	73	163.4	220	428.0
- 2	8.4	36	96.8	74	165.2	240	464.0
- 1	30.2	37	98.6	75	167.0	260	500.0
0	32.0	38	100.4	76	168.8	280	536.0
1	33.8	39	102.2	77	170.6	300	572.0
2	35.6	40	104.0	78	172.4	400	752.0
4	39.2	42	107.6	80	176.0	600	1112.0
5	41.0	43	109.4	81	177.8	700	1292.0
6	42.8	44	111.2	82	179.6	800	1472.0
7	44.6	45	113.0	83	181.4	900	1652.0
8	46.4	46	114.8	84	183.2	1000	1832.0

C = 5/9 (F. - 32)  
F = 9/5C. + 32

<sup>1</sup> Magnet wire tensile will change as the psi of magnet wire changes.

**Note:** Copper magnet wire is calculated at 33,000 psi. Aluminum magnet wire is calculated at 11,000 psi (EC grade). Magnet wire should be tensiled on each coil. After termination of the AMPLIVAR splice, the tensile strength will be 70% (min.) of the original magnet wire tensile values.

**Technical Information** (Continued)

Circular Mil Area (CMA) and Diameter for Magnet Wires (AWG Wire Size Range 52–25<sup>1/2</sup>)

AWG Bare Wire	Bare Wire Dia.		CMA Bare	Single Film Coated Dia.		CMA Single Film Coated	Heavy Film Coated Dia.		CMA Heavy Film Coated
	in.	mm		in.	mm		in.	mm	
52	.0008	.020	0.6	.0010	.025	1.0	.0011	.028	1.2
51	.0009	.023	0.8	.0011	.028	1.2	.0012	.031	1.5
50	.0010	.025	1.0	.0012	.031	1.5	.0013	.033	1.7
49	.0011	.028	1.2	.0013	.033	1.7	.0014	.035	2.0
48	.0012	.031	1.5	.0014	.035	2.0	.0015	.038	2.2
47	.0014	.035	2.0	.0016	.040	2.5	.0018	.045	3.1
46	.0016	.040	2.5	.0017	.043	2.9	.0019	.048	3.6
45	.0018	.045	3.1	.0019	.048	3.6	.0021	.053	4.4
44	.0020	.050	4.0	.0022	.056	4.8	.0025	.063	6.2
43	.0022	.056	4.8	.0025	.063	6.2	.0027	.069	7.3
42	.0025	0.06	6.3	.0028	0.07	8	.0030	0.08	9
41	.0028	0.07	7.8	.0031	0.08	10	.0034	0.09	12
40	.0031	0.08	9.6	.0035	0.09	12	.0038	0.10	14
39	.0035	0.09	12	.0039	0.10	15	.0043	0.11	18
38	.0040	0.10	16	.0045	0.11	20	.0049	0.12	24
37	.0045	0.11	20	.0050	0.13	25	.0055	0.14	30
36	.0050	0.13	25	.0056	0.14	31	.0060	0.15	36
35	.0056	0.14	31	.0062	0.16	38	.0067	0.17	45
35	.0056	0.14	31	.0062	0.16	38	.0067	0.17	45
34	.0063	0.16	40	.0069	0.18	48	.0075	0.19	56
33	.0071	0.18	50	.0077	0.20	59	.0085	0.22	72
32	.0080	0.20	64	.0084	0.21	71	.0095	0.24	90
31	.0089	0.23	79	.0092	0.23	85	.0105	0.27	110
30 <sup>1/2</sup>	.0095	0.24	90	.0099	0.25	98	.0111	0.28	123
30	.0100	0.25	100	.0106	0.27	112	.0116	0.29	135
29 <sup>1/2</sup>	.0107	0.27	115	.0114	0.29	130	.0123	0.31	151
29	.0113	0.29	128	.0120	0.30	144	.0130	0.33	169
28 <sup>1/2</sup>	.0120	0.30	144	.0126	0.32	159	.0137	0.35	187
28	.0126	0.32	159	.0136	0.35	185	.0144	0.37	207
27 <sup>1/2</sup>	.0134	0.34	180	.0144	0.37	207	.0153	0.39	234
27	.0142	0.36	202	.0152	0.39	231	.0161	0.41	259
26 <sup>1/2</sup>	.0151	0.38	225	.0160	0.41	256	.0170	0.43	289
26	.0159	0.40	258	.0170	0.43	289	.0179	0.45	320
25 <sup>1/2</sup>	.0169	0.43	289	.0180	0.46	324	.0190	0.48	361

### Technical Information (Continued)

Circular Mil Area (CMA) and Diameter for Magnet Wires (AWG Wire Size Range 25–8)

AWG Bare Wire	Bare Wire Dia.		CMA Bare	Single Film Coated Dia.		CMA Single Film Coated	Heavy Film Coated Dia.		CMA Heavy Film Coated
	in.	mm		in.	mm		in.	mm	
25	.0179	0.45	320	.0190	0.48	361	.0200	0.51	400
24 <sup>1/2</sup>	.0190	0.48	361	.0200	0.51	400	.0212	0.54	449
24	.0201	0.51	404	.0213	0.54	455	.0223	0.57	497
23 <sup>1/2</sup>	.0214	0.54	458	.0226	0.57	511	.0236	0.60	557
23	.0226	0.57	511	.0238	0.60	566	.0249	0.63	620
22 <sup>1/2</sup>	.0240	0.61	576	.0252	0.64	635	.0263	0.67	692
22	.0253	0.64	640	.0266	0.68	708	.0277	0.70	767
21 <sup>1/2</sup>	.0269	0.68	724	.0282	0.72	795	.0293	0.74	858
21	.0285	0.72	812	.0298	0.76	888	.0310	0.79	961
20 <sup>1/2</sup>	.0303	0.77	918	.0315	0.80	992	.0328	0.83	1,076
20	.0320	0.81	1,024	.0334	0.85	1,116	.0346	0.88	1,197
19 <sup>1/2</sup>	.0340	0.86	1,156	.0353	0.90	1,246	.0365	0.93	1,340
19	.0359	0.91	1,289	.0373	0.95	1,391	.0386	0.98	1,490
18 <sup>1/2</sup>	.0381	0.97	1,452	.0395	1.00	1,560	.0409	1.04	1,673
18	.0403	1.02	1,624	.0418	1.06	1,747	.0431	1.09	1,858
17 <sup>1/2</sup>	.0428	1.09	1,832	.0443	1.13	1,962	.0456	1.16	2,079
17	.0453	1.15	2,052	.0468	1.19	2,190	.0482	1.22	2,323
16 <sup>1/2</sup>	.0481	1.22	2,314	.0496	1.26	2,460	.0510	1.30	2,601
16	.0508	1.29	2,581	.0524	1.33	2,746	.0583	1.37	2,894
15 <sup>1/2</sup>	.0540	1.37	2,916	.0560	1.42	3,136	.0570	1.45	3,249
15	.0571	1.45	3,260	.0587	1.49	3,446	.0602	1.53	3,624
14 <sup>1/2</sup>	.0606	1.54	3,672	.0622	1.58	3,869	.0639	1.62	4,082
14	.0641	1.63	4,109	.0658	1.67	4,330	.0675	1.71	4,556
13 <sup>1/2</sup>	.0681	1.73	4,638	.0698	1.77	4,872	.0711	1.81	5,055
13	.0720	1.83	5,184	.0738	1.87	5,446	.0749	1.90	5,670
12 <sup>1/2</sup>	.0764	1.94	5,837	.0783	1.99	6,131	.0793	2.01	6,188
12	.0808	2.05	6,529	.0827	2.10	6,839	.0838	2.13	7,090
11 <sup>1/2</sup>	.0858	2.18	7,362	.0877	2.23	7,691	.0888	2.26	7,885
11	.0907	2.30	8,226	.0927	2.35	8,593	.0938	2.38	8,892
10 <sup>1/2</sup>	.0963	2.35	9,274	.0983	2.50	9,663	.0994	2.52	9,880
10	.1019	2.59	10,384	.1040	2.64	10,820	.1050	2.67	11,151
9	.1144	2.91	13,087	.1166	2.96	13,600	.1177	2.99	13,971
8	.1285	3.26	16,512	.1307	3.32	17,080	.1318	3.35	17,530

**Technical Information** (Continued)

Circular Mil Area (CMA) and Diameter for Lead Wires (AWG Wire Size Range 30–8)

Wire Size	Strands		Wire Area in Circ. Mils
	No.	Dia. (Mils)	
30	7	4.0	112
30	1	10.0	100
28	7	5.0	175
28	19	3.1	181
28	1	12.6	159
27	7	5.6	219
27	1	14.2	202
26	6	6.3	238
26	10	5.0	250
26	16	4.0	256
26	8	5.6	251
26	1	15.9	253
26	26	3.1	250
26	7	6.3	278
26	3	10.0	300
26 AN	12	5.0	300
25	10	5.6	314
25	8	6.3	318
25	1	17.9	320
24	10	6.3	397
24	8	7.1	403
24	16	5.0	400
24	4	10.0	400
24	1	20.1	404
24	26	4.0	416
24	13	5.6	408
24	7	8.0	448
24	56	2.8	439
24 AN	19	5.0	475
23	10	7.1	504
23	8	8.0	512
23	1	22.6	511
—	21	5.0	525
22	6	10.0	600
22	8	8.9	634
22	16	6.3	635
22	10	8.0	640
22	1	25.3	640
22	7	10.0	700
22 AN	19	6.3	754
20	10	10.0	1,000
20	1	10.0	1,024
20	26	6.3	1,032
20	7	12.6	1,111
20 AN	19	7.9	1,186
18	19	9.2	1,608
—	16	10.0	1,600
18	1	40.3	1,624
18	7	15.2	1,617
18	65	5.0	1,625
18	7	15.3	1,639

Wire Size	Strands		Wire Area in Circ. Mils
	No.	Dia. (Mils)	
—	41	6.3	1,627
—	7	16.0	1,792
18 AN	19	10.0	1,900
18 AN	19	11.3	2,426
16	7	19.2	2,580
16	1	50.8	2,581
16	65	6.3	2,580
16	19	11.7	2,601
16	105	5.0	2,625
—	26	10.0	2,600
16	7	20.0	2,800
14 AN	19	14.2	3,831
14	37	10.5	4,079
14	7	24.2	4,099
14	19	14.7	4,106
14	1	64.4	4,109
—	41	10.0	4,100
14	105	6.3	4,167
14	168	5.0	4,200
14	84	7.1	4,234
—	7	25.3	4,481
12	19	17.9	6,088
12 AN	19	17.9	6,088
12	259	5.0	6,475
12	19	18.5	6,503
12	7	30.5	6,512
12	37	13.3	6,545
12	1	80.8	6,529
12	165	6.3	6,549
12	84	8.9	6,654
10	7	36.0	9,072
—	37	16.0	9,472
10	414	5.0	10,350
10	37	16.7	10,319
10	1	101.9	10,384
10	7	38.5	10,376
10	19	23.4	10,404
—	41	15.9	10,365
10	105	10.0	10,500
9	7	43.0	12,943
9	1	114.4	13,087
9	525	5.0	13,125
8	7	45.0	14,175
8	133	11.1	16,386
8	37	21.1	16,472
8	1	128.5	16,512
8	7	48.6	16,533
8	19	29.5	16,534
8	49	18.4	16,589
8 AN	133	11.3	16,982



















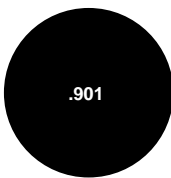

## Terminal Stud Hole Size

### Use to Select Proper Size Terminal

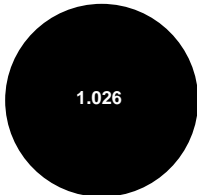
The chart shows sizes and dimensions of various studs and the corresponding terminal stud hole sizes used with AMP devices.

For example, with stud #5 (.125 [3.18] Diameter), use AMP device listed for #5 stud (.129 [3.28] Hole Diameter).

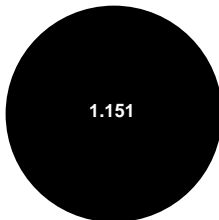
Terminal stud hole sizes may easily be checked by fitting sample terminal to black circle.

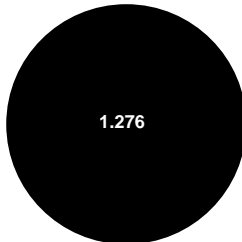
Stud Size		Stud Dia.	Minimum Terminal Hole Diameter	Stud Size		Stud Dia.	Minimum Terminal Hole Diameter	
U.S. Cust.	Metric			U.S. Cust.	Metric			
#0		.060		.064				
#1		.073		.077	5/8"	M16	.625	
#2	M2	.086		.090				
#3		.099		.103				
#4		.112		.116	3/4"		.750	
#5	M3	.125		.129				
#6	M3.5	.138		.142				
#8	M4	.164		.168	7/8"	M22	.875	
#10		.190		.194				
#12		.216		.220				
#14		.242		.247	1"		1.000	
1/4"	M6	.250		.260				
5/16"	M8	.312		.323				
3/8"		.375		.385	1-1/8"		1.125	
7/16"		.437		.448				
1/2"	M12	.500		.510	1-1/4"		1.250	

Dimensions are in inches and millimeters unless otherwise specified. Values in brackets are metric equivalents.

Dimensions are shown for reference purposes only. Specifications subject to change.

Technical Support  
USA: 1-800-522-6752  
Canada: 1-905-475-6222  
Mexico: 01-800-733-8926

www.tycoelectronics.com

## Part Number Index

Note: This index lists all cataloged parts by base no. only. Complete part nos. (with prefixes and/or suffixes) are shown on the page(s) indicated.

Part No.	Page	Part No.	Page	Part No.	Page
41765	50	61710	54	62743	18
41766	50	62000	49	62755	53
41770	50	62001	49	62766	8
41899	50	62002	49	62780	26
41900	50	62040	49	62781	26
41904	50	62044	51	62816	27
42076	50	62069	56	62833	5
42119	50	62080	56	62835	53
42192	50	62131	60	62841	5
42776	50	62157	49	62842	5
42778	50	62194	51	62874	11
42779	50	62200	49	62888	18
42780	50	62201	49	62895	7
50717	87	62243	62	62896	7
50719	86	62244	62	62897	7
50720	86	62295	49	62898	7
51826	84	62303	49	62903	8
51941	84	62304	49	62904	17
51942	84	62305	49	62912	5
51979	86	62306	49	62922	55
51982	87	62307	49	62923	21
51986	87	62308	49	62928	10
51989	87	62309	49	62934	11
51992	87	62310	49	62935	5
51995	87	62311	49	62938	11
52001	84	62341	51	62939	20
52004	84	62381	58	62958	10
52007	84	62420	5	62992	9
52010	84	62429	5	63005	8
52013	84	62430	11	63018	18
52016	84	62431	5	63026	20
52019	84	62438	11	63027	20
52587	86	62439	11	63036	10
52590	86	62445	55	63039	10
52745	85	62447	55	63041	27
52746	85	62458	9	63044	5
52747	85	62459	9	63055	20
52748	85	62511	17	63062	16
52749	85	62512	17	63063	16
52750	85	62513	17	63064	21
52751	85	62514	17	63087	8
52752	85	62524	5	63107	18
52791	85	62526	5	63108	18
52792	85	62527	5	63109	18
60177	57	62600	20	63110	15
60318	53	62606	26	63128	20
60319	53	62608	10	63132	20
60320	53	62609	10	63133	20
60321	53	62610	10	63136	56
60322	53	62651	20	63140	56
60323	53	62652	20	63145	16
60325	53	62653	20	63147	53
60384	56	62655	20	63155	21
60385	56	62656	20	63159	20
60752	54	62657	20	63160	11
61074	50	62658	20	63161	27
61151	54	62661	17	63165	56
61166	51	62663	17	63177	15
61440	55	62665	9	63178	15
61442	55	62666	9	63199	27
61603	55	62670	51	63200	20
61604	55	62678	17	63203	20



## Part Number Index (Continued)

Part No.	Page	Part No.	Page	Part No.	Page	Part No.	Page
63207	20	63486	16	63708	19	63898	20
63208	14	63489	13	63710	23	63899	13
63209	14	63494	17	63711	23	63903	24
63216	12	63495	21	63712	23	63906	62
63218	7	63499	20	63713	23	63907	62
63235	9	63505	18	63714	23	63908	62
63236	9	63506	57	63716	23	63909	12
63237	9	63510	17	63717	23	63910	12
63247	12	63511	17	63718	23	63920	20
63253	10	63529	15	63719	23	63926	12
63254	18	63530	15	63720	23	63927	12
63255	18	63531	8	63722	14	63940	57
63256	18	63532	8	63725	5	63941	57
63263	21	63533	8	63734	23	63942	57
63273	17	63544	18	63735	23	63944	57
63276	15	63551	5	63736	23	63955	27
63277	14	63561	50	63737	23	63956	27
63278	14	63562	50	63738	23	63964	58
63293	17	63564	50	63740	23	63965	12
63308	14	63565	11	63741	23	63972	13
63309	20	63569	14	63742	23	63973	13
63319	15	63570	14	63743	23	63974	13
63326	14	63571	20	63744	23	63975	6
63328	20	63574	7	63746	16	63983	19
63330	15	63584	17	63754	5	63995	19
63331	15	63585	17	63760	18	63996	19
63336	21	63590	5	63762	19	63999	27
63340	18	63591	5	63773	12	184076	86
63353	19	63598	21	63775	7	184079	86
63364	7	63599	19	63776	17	184082	87
63371	21	63601	20	63777	16	184084	87
63376	15	63607	20	63778	27	184087	87
63397	7	63612	53	63782	18	184090	87
63399	53	63613	26	63786	5	184092	87
63403	20	63614	20	63788	14	184094	87
63410	7	63618	20	63789	5	281006	60
63420	9	63621	51	63795	26	350571	54
63425	21	63622	56	63806	12	360033	60
63427	19	63623	56	63807	12	360050	60
63428	19	63631	7	63808	12	360051	61
63429	18	63632	6	63810	12	360052	61
63431	51	63636	5	63816	21	466010	56
63433	15	63641	9	63818	11	466510	55
63434	15	63643	19	63819	11	466816	56
63443	14	63645	11	63827	16	485044	53
63444	14	63649	53	63828	27	485079	53
63446	53	63658	5	63829	17	505036	54
63447	18	63659	10	63844	26	505044	54
63448	60	63660	10	63845	26	505071	53
63453	62	63661	10	63852	17	505072	53
63454	62	63662	5	63855	5	505075	53
63455	62	63663	17	63856	10	505079	54
63458	7	63664	17	63864	54	520995	61
63459	21	63665	17	63870	55	521078	60
63460	21	63666	19	63871	55	566410	57
63461	17	63667	19	63879	14	566411	57
63463	12	63668	17	63880	14	567343	56
63464	21	63669	17	63881	21	567451	56
63465	21	63670	17	63882	21	640212	54
63478	18	63675	27	63883	21	680353	57
63480	58	63690	9	63888	24	680421	57
63484	55	63702	11	63889	55	770642	55

Dimensions are in inches and millimeters unless otherwise specified. Values in brackets are metric equivalents.

Dimensions are shown for reference purposes only. Specifications subject to change.

Technical Support  
USA: 1-800-522-6752  
Canada: 1-905-475-6222  
Mexico: 01-800-733-8926

www.tycoelectronics.com

## Part Number Index (Continued)

Part No.	Page	Part No.	Page	Part No.	Page	Part No.	Page
964156	49	1217384	50	1601005	36	1601151	36
1217000	27	1217405	11	1601006	37	1601155	35
1217004	18	1217406	7	1601008	35	1601159	38
1217011	5	1217417	57	1601009	35	1601161	38
1217013	11	1217426	6	1601011	37	1601421	29, 32, 34, 39
1217026	5	1217427	6	1601013	37	1601423	29, 37, 38
1217029	55	1217428	6	1601018	37	1601424	29, 35, 39
1217031	20	1217429	6	1601020	37	1601425	29, 35-39
1217032	12	1217430	16	1601021	37	1601427	29, 37
1217039	55	1217457	9	1601028	38	1601431	29, 35, 36
1217042	19	1217458	9	1601033	37	1601432	30, 39
1217051	12	1217459	11	1601035	37	1601433	30, 32, 34
1217052	12	1217460	11	1601037	35	1601434	30, 37
1217065	17	1217470	7	1601039	36	1601435	30, 38
1217067	6	1217491	19	1601040	37	1601436	30, 32
1217068	6	1217492	19	1601041	35	1601437	30
1217069	6	1217493	18	1601044	38	1601438	30, 35, 38
1217072	55	1217497	23	1601045	36	1601440	30, 32, 34
1217073	55	1217516	23	1601046	32	1601447	30, 32, 35-39
1217075	19	1217529	27	1601049	37	1601462	30, 32
1217084	5	1217533	6	1601051	35	1601463	30, 32
1217090	19	1217538	9	1601052	38	1601470	30, 39
1217122	62	1217579	6	1601056	32	1601503	80
1217128	17	1217588	21	1601058	37	1601504	80
1217132	7	1217592	18	1601059	36	1601507	77
1217146	10	1217593	13	1601061	38	1601511	79
1217152	20	1217595	12	1601063	35	1601513	79
1217172	62	1217596	13	1601064	36	1601514	77
1217173	62	1217613	8	1601065	35	1601520	76
1217174	62	1217624	57	1601066	35	1601528	78
1217175	62	1217641	11	1601068	37	1601529	78
1217176	62	1217642	11	1601072	37	1601531	78
1217178	17	1217666	23	1601073	36	1601532	78
1217181	61	1217670	62	1601074	32	1601538	72
1217186	61	1217671	62	1601075	39	1601539	72
1217187	61	1217672	62	1601077	39	1601540	72
1217189	5	1217688	6	1601085	36	1601542	80
1217190	5	1217689	6	1601095	35	1601545	80
1217191	5	1217690	6	1601097	36	1601546	80
1217192	5	1217691	6	1601099	35	1601547	80
1217196	11	1217709	24	1601104	35	1601548	79
1217200	61	1217714	23	1601110	35	1601549	79
1217209	8	1217736	5	1601112	36	1601550	76
1217210	13	1217745	13	1601115	38	1601551	76
1217211	13	1217746	13	1601116	36	1601553	76
1217214	7	1217757	5	1601117	32	1601555	80
1217221	6	1217783	16	1601118	38	1601559	72
1217231	27	1217804	27	1601120	35	1601560	72
1217234	5	1217824	5	1601121	35	1601562	80
1217243	17	1217830	27	1601125	32	1601564	80
1217261	61	1217835	56	1601128	35	1601566	79
1217262	60	1217853	8	1601130	39	1601569	79
1217263	60	1217856	20	1601131	39	1601571	79
1217264	60	1217857	18	1601133	36	1601572	76
1217302	10	1217858	8	1601136	32	1601573	76
1217324	7	1217860	20	1601137	39	1601575	75
1217339	19	1217870	20	1601138	35	1601577	75
1217355	6	1217875	7	1601139	38	1601578	75
1217356	6	1601000	32	1601140	34	1601580	80
1217357	6	1601002	38	1601142	37	1601582	80
1217358	6	1601003	38	1601147	35	1601583	80
1217368	5	1601004	37	1601149	39	1601584	80

**Part Number Index** (Continued)

Part No.	Page	Part No.	Page	Part No.	Page	Part No.	Page
1601586	79	1601640	79	1601706	71	1601807	76
1601587	77	1601642	78	1601707	71	1601808	79
1601588	77	1601644	72	1601709	78	1601809	79
1601591	77	1601646	72	1601710	78	1601810	79
1601593	75	1601647	72	1601711	78	1601811	77
1601596	80	1601649	80	1601712	78	1601814	71
1601597	79	1601650	79	1601716	72	1601818	77
1601599	79	1601651	79	1601717	71	1601819	77
1601600	79	1601652	79	1601718	71	1601820	77
1601601	77	1601654	79	1601719	71	1601823	71
1601603	77	1601655	77	1601721	79	1601824	71
1601604	72	1601656	77	1601722	79	1601825	80
1601606	72	1601658	77	1601723	79	1601827	79
1601607	71	1601660	77	1601726	78	1601828	77
1601608	71	1601661	77	1601729	78	1601829	77
1601610	80	1601664	77	1601730	78	1601832	72
1601611	80	1601665	77	1601731	78	1601833	71
1601612	80	1601667	77	1601733	78	1601835	71
1601614	79	1601668	77	1601750	71	1601837	79
1601617	79	1601669	76	1601754	78	1601841	78
1601618	79	1601675	72	1601755	78	1601842	71
1601619	79	1601677	71	1601761	71	1601844	72
1601620	77	1601678	71	1601764	78	1601845	72
1601623	77	1601680	78	1601765	78	1601846	71
1601625	77	1601681	78	1601766	78	1601847	71
1601628	77	1601682	78	1601768	76	1601848	71
1601629	77	1601683	72	1601769	75	1601852	78
1601630	77	1601687	79	1601771	75	1601853	75
1601631	77	1601689	78	1601793	72	1601857	71
1601632	75	1601691	78	1601794	71	1601953	91
1601633	75	1601693	78	1601795	80	111-000-001	91
1601635	80	1601694	78	1601797	76		
1601637	72	1601695	78	1601798	76		
1601639	71	1601705	71	1601800	72		

---

**Engineering Notes**

---



**Power Splice** (Continued)



Type	Magnet Wire Range CMA	Lead Wire Range CMA	Part Number Reeled
A	15,000-30,000	4200-10,900	1601953-11

<sup>1</sup> Total combined CMA not to exceed 38000.

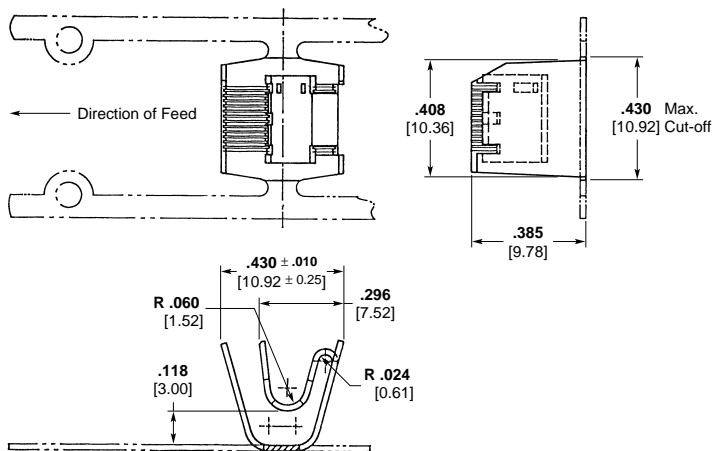
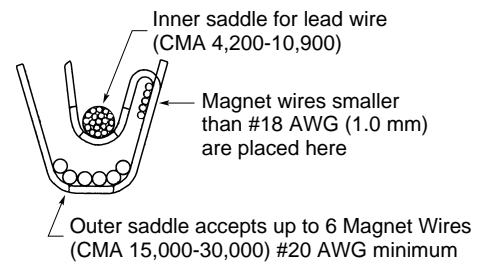
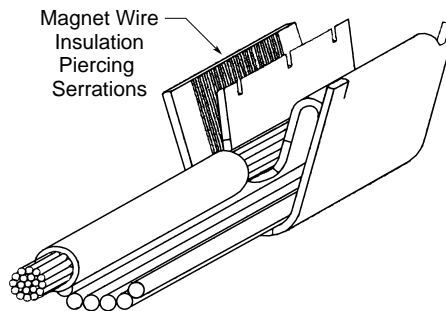

Part Number 111-000-001

Power Splice

## Application Tooling

### Power Splice Machine for Mag Wire/Lead Wire Pigtail Splice Termination

#### Product Facts

- Terminate Mag Wire and Lead Wire Together
- Maximum 38,000 CMA Crimp
- Servo-Driven 5-Ton Terminator
- Heavy Duty Air-Feed Applicator
- One Control Cabinet Operates 2 Terminators
- Programmable Crimping Ram Stroke
- Hand Held Control Pendant
- Crimp Force Monitoring
- Crimp Height Sequencing



For quick, easy and reliable pigtail splice termination of magnet wire and solid or stranded lead wire, Tyco Electronics offers the new Power Splice terminator and applicator.

The Power Splice terminator and applicator will terminate pigtail splices consisting up to two (2) solid or stranded copper lead wires in wire size from 10-14 AWG and having a Circular Mil Area (CMA) of 4,200-10,000. The splice will simultaneously accept combinations of multiple copper magnet wires in a range of 11-20 AWG. Total magnet wire CMA can fall in the range of 8,000-30,000. Total CMA capable of being crimped in the Power Splice terminal is between 8,000-38,000.

The Power Splice terminator incorporates a servo motor drive 5-ton terminator with an air feed applicator to create a high quality crimp. The application equipment is controlled through a handheld pendant and incorporates crimp force monitoring, crimp height sequencing, and a programmable ram stroke. A special machine guard to facilitate proper wire placement into the terminal is also provided to ease terminal loading and provide operator safety.

#### Solderless Pigtail Splice Terminations

- No need to pre-strip the magnet wire
- No wire embrittlement due to solder
- No Solder fumes
- Compact clean termination

## X-ON Electronics

Largest Supplier of Electrical and Electronic Components

*Click to view similar products for [Terminals](#) category:*

*Click to view products by [TE Connectivity](#) manufacturer:*

Other Similar products are found below :

[HT-13-10](#) [71M-250-32-NB](#) [01-2065-1-0216](#) [00581P0075](#) [M10-10RX](#) [M10BCK](#) [60205-1](#) [604200-1](#) [60598-1-CUT-TAPE](#) [60617-1-C](#) [60873-1](#) [M14-516R/SK](#) [M14-6RSX](#) [M18-10FLX](#) [M18-8FBX](#) [M18-8R/LX](#) [M18BCK](#) [61314-6-C](#) [61-S](#) [61-SN-A](#) [62-NBM-A](#) [63-S](#) [640179-1](#) [640917-2-CUT-TAPE](#) [6501550002](#) [66107-2-C](#) [66107-4-C](#) [696683-1](#) [696834-1](#) [696861-1](#) [696931-1](#) [696999-1](#) [M8-516RK](#) [M86700006](#) [MA250DMFMX-A](#) [701-2007](#) [701-2307](#) [701-7761-03](#) [70F-110-32-PB](#) [718-N-A](#) [71M-187-20-NBL](#) [71M-250-32-NBL](#) [72F-187-20-NBL](#) [72M-250-32-NBL](#) [7310](#) [73F-250-32](#) [73F-250-32-NBL](#) [73F-250-32-NL](#) [F14-10C](#) [F-1M](#)