

Customer: _____

No. F3853574M

Date: Nov. 16, 1994

Attention: _____

Your ref. No: _____

Your Part. No: STEC11B01

SPECIFICATIONS

STÜCK ANGEBOTSMUSTER BEIGEFÜGT
PIECES QUOTATION SAMPLE(S) ATTACHED

ALPS: _____

MODEL EC11B15242

Spec. No. : _____

Sample No. : F3853574M

RECEIPT STATUS

RECEIVED

By. Date _____

Signature _____

Name

Title

ALPS ELECTRIC CO., LTD.

HEAD OFFICE
1-7, YUKIGAYA-OHTSUKA-CHO.
OHTA-KU, TOKYO 145 JAPAN

DSG'D

H. Miura

APP'D

S. Mizushima

ENG. DEPT. DIVISION

Sales _____

SPECIFICATIONS

1. THIS SPECIFICATIONS APPLY TO EC11B15242 ROTARY ENCODER

2. CONTENTS OF THIS SPECIFICATIONS.

4LA211-11
4LA2114-11
LA2114229

3. MARKING

· MARKING ON ALL UNITS
DATE CODE

4. REMARKS

· FURNISH PACKAGE
NUT: 1, WASHER: 1
· NOTES

· Marking ⇒ in specifications shows standard and condition for application.

1. 一般事項 General

1-1 適用範囲 SCOPE

この仕様書は主として電子機器に用いる微小電流回路用11形薄形ロータリーエンコーダに適用する。
This specification applies to 11mm size low-profile rotary encoder (incremental type) for microscopic current circuits, used in electronic equipment.

1-2 標準状態 Standard atmospheric conditions

測定は特に指定のない限り、次の状態で行なう。
Unless otherwise specified, the standard range of atmospheric conditions for making measurements and tests is as follows:

温度 Ambient temperature : ~~5°C to 35°C~~ 15°C to 35°C
 相対湿度 Relative humidity : ~~45% to 85%~~ 25% to 85%
 気圧 Air pressure : 860hPa to 1060hPa

但し、疑義を生じた場合は、次の標準状態で行なう。

If there is any doubt about the results, measurements shall be made within the following limits:

温度 Ambient temperature : ~~20 ± 2°C~~ 20 ± 1°C
 相対湿度 Relative humidity : ~~60% to 70%~~ 63% to 67%
 気圧 Air pressure : 860hPa to 1060hPa

1-3 使用温度範囲

Operating temperature range : -30°C to +70°C

1-4 保存温度範囲

Storage temperature range : -40°C to +85°C

2. 構造 Construction

2-1 寸法 Dimensions

添付組立図による。
Refer to attached drawing.

3. 定格 Rating

3-1 定格容量

Rating D. C. 5V 10mA (1mA MIN)

4. 電気的性能 Electrical characteristics

項目 Item	条件 Conditions	規格 Specifications													
4-1 出力信号 Output signal format	<Fig 1>	A, B2信号の位相差出力とし、詳細は<fig. 1>の通りとする。 (破線はクリック付きの場合のクリックの位置を示す。) 2 Phase-different signals (SignalA, signalB) Details shown in <fig. 1>. (The broken line shows detent position of with-detent type.)													
		<table border="1"> <thead> <tr> <th>軸回転方向 Shaft rotational direction</th> <th>信号 Signal</th> <th>出力波形状 Output</th> </tr> </thead> <tbody> <tr> <td rowspan="2" style="text-align: center;">時計方向 C. W.</td> <td>A(A-C端子番) A(Terminal A-C)</td> <td></td> </tr> <tr> <td>B(B-C端子番) B(Terminal B-C)</td> <td></td> </tr> <tr> <td rowspan="2" style="text-align: center;">反時計方向 C. C. W.</td> <td>A(A-C端子番) A(Terminal A-C)</td> <td></td> </tr> <tr> <td>B(B-C端子番) B(Terminal B-C)</td> <td></td> </tr> </tbody> </table>	軸回転方向 Shaft rotational direction	信号 Signal	出力波形状 Output	時計方向 C. W.	A(A-C端子番) A(Terminal A-C)		B(B-C端子番) B(Terminal B-C)		反時計方向 C. C. W.	A(A-C端子番) A(Terminal A-C)		B(B-C端子番) B(Terminal B-C)	
		軸回転方向 Shaft rotational direction	信号 Signal	出力波形状 Output											
		時計方向 C. W.	A(A-C端子番) A(Terminal A-C)												
B(B-C端子番) B(Terminal B-C)															
反時計方向 C. C. W.	A(A-C端子番) A(Terminal A-C)														
	B(B-C端子番) B(Terminal B-C)														

ALPS ALPS ELECTRIC CO., LTD.

APPR 設 2 93.8.-6	CHKD. W設 2 92.8.-3 溝淵	DSGD 設 2 93.8.-3 三浦	TITLE ROTATIONAL ENCODER 回転形エンコーダ
△ 2 74-0303	石川 溝淵 三浦	石川	DOCUMENT NO. 4LA211-11 (1/5)
SYMB	DATE	APPD	CHKD

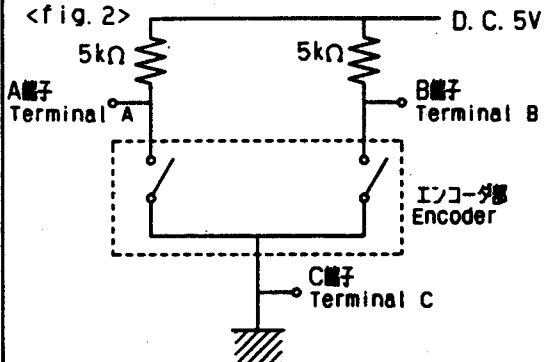
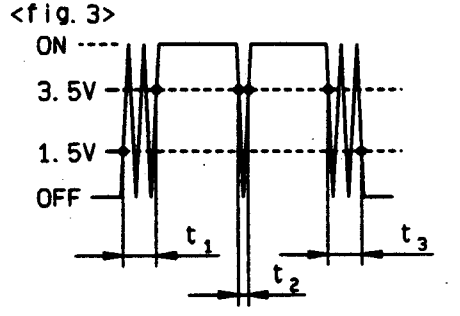
項目 Item	条件 Conditions	規格 Specifications
4-2 分解能 Resolution	1回転で出力されるパルス数 Number of pulses in 360° rotation.	各相 15パルス/360° 15 pulses/360° for each phase (2クリックパルス) (2click 1pulse)
4-3 スイッチング特性 Switching characteristics	下記測定回路<fig. 2>を用い、回転角を360°・S ⁻¹ の速さで回転し測定する。 Measurement shall be made under the condition as follows. 1) Shaft rotational speed : 360°・S ⁻¹ 2) Test circuit : <fig. 2>  <fig. 3>  (注記) コードON状態 : 出力電圧が3.5V以上の状態を言う。 コードOFF状態 : 出力電圧が1.5V以下の状態を言う。 (note) Code-ON area : The area which the voltage is 3.5V or more. code-OFF area : The area which the voltage is 1.5V or less.	
1) チャタリング Chattering	コードのOFF→ON及びON→OFFの際の、出力1.5V~3.5Vの通過時間にて規定する。 Specified by the signal's passage time from 3.5V to 1.5V or from 1.5V to 3.5V of each switching position (code OFF→ON or ON→OFF).	$t_1, t_3 \leq 2\text{ms}$
2) 揺動ノイズ (バウンス) Sliding noise (Bounce)	コードONの部分の3.5V以下の電圧変動時間とし、チャタリング t_1, t_3 両者との間に1mS以上の3.5V以上のON部分を有するものとする。また、揺動ノイズ間に3.5V以上の範囲が1mSある場合は、別の揺動ノイズと判断する。 Specified by the time of voltage change exceed 3.5V in code-ON area. When the bounce has code-ON time less than 1mS between chatterings (t_1 or t_3), the voltage change shall be regarded as a part of chattering. When the code-ON time between 2 bounces is less than 1mS, they are regarded as 1 linked bounce.	$t_2 \leq 2\text{ms}$
3) 揺動ノイズ Sliding noise	コードOFFの部分の電圧変動 The voltage change in code-OFF area.	1.5V以下 1.5V MAX

ALPS ALPS ELECTRIC CO., LTD.				
APPD.	CHKD.	DSGD.	TITLE ROTATIONAL ENCODER 回転形エンコーダ	
設2 93.8.-6 石川	1V設2 92.7.28 溝淵	設2 93.7.23 三浦	DOCUMENT NO. 4LA211-11 (2/5)	
SYMB	DATE	APPD	CHKD	DSGD

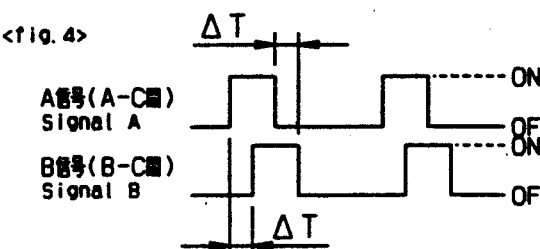
項目 Item	条件 Conditions	規格 Specifications
4-4 位相差 Phase-difference	<p>360°・S⁻¹の定速にて操作軸を回転する。 Measurement shall be made under the condition which the shaft is rotated in 360°・S⁻¹ (constant speed).</p> <p><fig. 4></p>  <p>注意事項 露出接点ですので手動操作時の出力波形はご使用されるツマミ径、軸の回転速度によって変化します。回転設計時は実機にて確認願います。 Note : Above specification (4-4) is changeable. When operate by manual. Please check performance using actual circuit and knob.</p>	<p><fig. 4>において ΔT ≥ 6msec In <fig. 4></p>
4-5 絶縁抵抗 Insulation resistance	<p>端子-軸受間にてD. C. 250V1mA印加する。 Measurement shall be made under the condition which a voltage of 250V D. C. 1mA is applied between individual terminals and bushing.</p>	<p>端子-軸受間にて100MΩ以上 Between individual terminals and bushing: 100MΩ MIN.</p>
4-6 耐電圧 Dielectric strength	<p>端子-軸受間にてA. C. 300V1分間又は、A. C. 360V2秒間印加する。(リーク電流1mA) A voltage of 300V A. C. shall be applied for 1min or a voltage of 360V A. C. shall be applied for 2sec between individual terminals and bushing. (Leak current:1mA)</p>	<p>焼損・アーク・絶縁破壊がないこと。 Without damage to parts arcing or breakdown.</p>

500VAC

5. 機械的性能 Mechanical characteristics

項目 Item	条件 Conditions	規格 Specifications
5-1 全回転角度 Total rotational angle		<p>360° (エンドレス) 360° (Endless)</p>
5-2 クリックトルク Detent torque	<p>→ (クリック付きのみ適用) (Applied for with-detent type)</p>	<p>12 ± 7mN・m (122.4 ± 71.4gf・cm)</p>
回転トルク Rotational torque	<p>(クリックなしのみ適用) (Applied for without-detent type)</p>	<p>5mN・m 以下。 (51gf・cm MAX.)</p>
5-3 クリック点数及び位置 Number and position of detents.	<p>→ (クリック付きのみ適用) (Applied for with-detent type)</p>	<p>30点クリック 30 detents (ステップ角度 12° ± 3°) (Step angle: 12° ± 3°)</p>
5-4 端子強度 Terminal strength	<p>端子先端の任意の方向に5N(510gf)の静荷重を1分間加える。 A static load of 5N(510gf) be applied to the tip of terminals for 1minute in any direction.</p>	<p>端子の破損、著しい力タがないこと。 但し、端子の曲がりは可とする。 Without damage or excessive looseness of terminals. Terminal bend is permitted.</p>
5-5 軸の押し引き強度 Push-pull strength of shaft	<p>軸の押し及び引き方向に100N(10.2kgf)の静荷重を10秒間加える。(セッティング後) Push and pull static load of 100N(10.2kgf) shall be applied to the shaft in the axial direction for 10s. (After installing)</p>	<p>軸の破損、著しいガタのないこと。 過剰に異音がないこと。△ Without damage or excessive play in shaft. No excessive abnormality in rotational feeling.</p>

 ALPS ELECTRIC CO., LTD.				
APPD	CHKD	DSGD	TITLE ROTATIONAL ENCODER 回転形エンコーダ	
設2 93.8.6 石川	WR2 92.7.28 溝淵	設2 93.7.23 三浦	DOCUMENT NO.	
△2	94-03-03	石川	溝淵	三浦
SYMB	DATE	APPD	CHKD	DSGD
			4LA211-11 (3/5)	

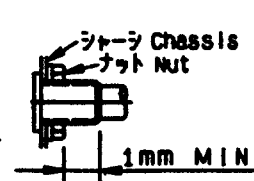
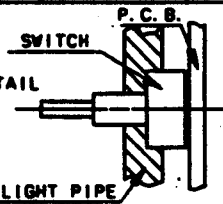
項目 Item	条件 Conditions	規格 Specifications								
5-6 軸受ネジ締付強度 Bushing nut tightening strength	(ネジ 付きのみ適用) (Applied for with-thread type) <fig. 5>を満足するように締付る。 Tighten the nut according to <fig. 5> <div style="text-align: right; margin-top: 10px;">  <p>シャシ Chassis ナット Nut 1mm MIN</p> </div>	1N·m(10.2kgf·cm)以上 1N·m(10.2kgf·cm) MIN.								
5-7 軸ガタ Shaft wobble	軸先端から55mmの位置に50mN·m(510gf·cm)の曲げモーメントを加える。 A momentary load of 50mN·m(510gf·cm) shall be applied at the point 5mm from the tip of the shaft in a direction perpendicular to the axis of shaft.	<table border="1" style="width:100%; border-collapse: collapse;"> <tr> <td>軸受長 Bushing length (mm)</td> <td>軸ガタ Wobble 以下 (mm-p less)</td> </tr> <tr> <td>3.5</td> <td>1.4xL/30</td> </tr> <tr> <td>5</td> <td>1.1xL/30</td> </tr> <tr> <td>7</td> <td>0.7xL/30</td> </tr> </table> Lは取付長さで比例計算する。 L: Measurement point from mounting surface of bushing.	軸受長 Bushing length (mm)	軸ガタ Wobble 以下 (mm-p less)	3.5	1.4xL/30	5	1.1xL/30	7	0.7xL/30
軸受長 Bushing length (mm)	軸ガタ Wobble 以下 (mm-p less)									
3.5	1.4xL/30									
5	1.1xL/30									
7	0.7xL/30									
5-8 軸のラスト方向ガタ Shaft play in axial direction		0.4mm-p以下 0.4mm-p MAX.								
5-9 軸の回転方向ガタ Rotation play at the click position	(クリック付きのみ適用) (Applied for with-detent type) 角度器にて測定する。 Measure with Jig for rotational angle.	5度以内 5° MAX.								
5-10 はんだ耐熱 Resistance to soldering heat	7条の「はんだ付け条件」による。 Specified by the clause 7 "Soldering conditions".	絶縁体の変形、破壊のないこと。 成形品に異常のないこと。 There shall be no deformation or cracks in molded part. No excessive abnormality in rotational feeling.								
5-11 取付け上の注意 Notice for mounting	右図の挿込スイッチ本体を挿えてご使用下さい。セッ側でスイッチ本体の引き及び回転方向の「イト」が無い場合は、はんだ付けだけの固定となり、はんだ付け信頼性及びスイッチ本体強度が不安定となる可能性があります。 Hold the bushing use front panel or light pipe. Because this switch not has thread. If don't hold the bushing, the switch maybe become intermittent or rough mounting after soldering by knob stopper face.									

6. 耐久性能 Endurance characteristics.

項目 Item	条件 Conditions	規格 Specifications
6-1 回転寿命性能 Rotational life	無負荷で軸を毎時500サイクルの速で、15,000回転連続動作を行う。但し、試験途中5,000で中間測定を行う。(1サイクルは、360°1往復) The shaft of encoder shall be rotated to 15,000 cycles at a speed of 500cycles per hour without electrical load. after which measurements shall be made. However, an interim measurement shall be made immediately after 5,000 cycles. (1 cycle: rotate 360° CCW rotate 360° CW)	クリックトルク: 初回規格値に対し ^{+10%} その他、初回規格を満足すること。 Detent torque: Relative to the previously specified value. ^{+10%} Except above items, specifications in Δ clause 4.1-5 Δ 4.7-8 and 5.1-3 shall be satisfied.

ALPS ALPS ELECTRIC CO., LTD.				
	APPD.	CHKD.	DSGD.	TITLE ROTATIONAL ENCODER 回転形エンコーダ
	設2 93.8.5 石川	WR2 92.7.28 清洲	設2 93.7.23 三浦	DOCUMENT NO.
Δ 2	94.03.03	石川	清洲	三浦
SYMB	DATE	APPD	CHKD	DSGD
				4LA211-11 (4/5)
				O R

CLASS No.	TITLE	
-----------	-------	--

7. はんだ付け条件 Soldering conditions

7-1 手はんだの場合 Manual soldering

温度300°C以下、時間3秒以内
 Bit temperature of soldering iron : 300°C or less.
 Application time of soldering iron : within 3s.

7-2 ティップはんだの場合 Dip soldering

使用基板 : t1.6両面銅箔基板
 Printed wiring board: Both-sided copper clad laminate board with thickness of 1.6mm.

フラックス : 比重0.82以上のフラックスを用い泡立式フラクサーにて浸漬高さは、基板厚の3分の2。

- Flux:
- Specific gravity: 0.82 or more.
 - Flux shall be applied to the board using a bubble foaming type fluxer.
 - The board shall be soaked in the flux bubble only to the 2/3 of its thickness.

プリヒート : 基板表面温度100°C以下、時間1分以内
 Preheating:
 -Surface temperature of board: 100°C or less.
 -Preheating time: within 1 min.

はんだ : 温度260°C以下、時間3秒以内
 Soldering:
 -Solder temperature: 260°C or less.
 -Immersion time: within 3s.

以上の工程を1回または2回通過する。
 Apply the above soldering process for 1 or 2 times.

					 ALPS ELECTRIC CO., LTD.			
					APPD.	CHKD.	DSGD.	TITLE ROTATIONAL ENCODER
					設2	WVZ 2	設2	回転エンコーダ
					93.8.-6	92.7.28	93.7.23	DOCUMENT NO.
					石川	溝淵	三浦	4LA211-11 (5/5)
SYMB	DATE	APPD	CHKD	OSGD				

OR

CLASS NO.	TITLE プッシュモーメンタリスイッチ規格書 PUSH MOMENTARY SWITCH SPECIFICATION	(SW02)
-----------	---	--------

1. 定格容量(抵抗負荷) D. C. 16V3A (10mA MIN)
Switch rating (Resistor load)

2. 電気的性能 Electrical characteristics

項目 Item	条件 Conditions	規格 Specifications
2-1 接触抵抗 contact resistance	D. C. 5V10mA電圧降下法にて測定する。 Measured by the 10mA 5V D. C. voltage drop method.	100mΩ以下 100mΩ MAX.
2-2 チャタリング Chattering	1サイクル (OFF-ON-OFF) 1秒で動作させる。 Switch is operated at the rate of 1 cycle 1 sec. The 1 cycle shall be OFF-ON-OFF.	10msec以下 Less than 10msec
2-3 絶縁抵抗 Insulation resistance	端子-軸受間にD. C. 250V1mA印加する。 Measurement shall be made under the condition which a voltage of 250V D. C. 1mA is applied between individual terminals and bushing.	端子-軸受間にて100MΩ以上 Between individual terminals and bushing: 100MΩ MIN.
2-4 耐電圧 Dielectric strength	端子-軸受間にA. C. 300V1分間又は、A. C. 360V2秒間印加する。(リーク電流1mA) A voltage of 300V A. C. shall be applied for 1min or a voltage of 300V A. C. shall be applied for 2sec between individual terminals and bushing. (Leak current:1mA)	焼損・アーク・絶縁破壊がないこと。 Without damage to parts arcing or breakdown.

注記: 軸・スイッチ端子間は絶縁されております。
Note: Shaft is insulated from switch terminal.

3. 機械的性能 Mechanical characteristics

項目 Item	条件 Conditions	規格 Specifications
3-1 スイッチ回路・接点数 Contact arrangement		単極単投(Push on) S. P. S. T. (Push on)
3-2 スイッチ移動量 Switching stroke		0.5 ^{±0.05} mm
3-3 スイッチ作動力 Switch operation force		6±3N(612±306gf)

4. 耐久性能 Endurance characteristics.

項目 Item	条件 Conditions	規格 Specifications
4-1 寿命特性 Operating life	定格負荷にて25,000回に断続動作を行う。 但し、試験途中5,000で中間測定を行う。 The shaft of encoder shall be rotated to 25,000 cycles at a speed of 500cycles per hour without electrical load. after which measurements shall be made. However, an interim measurement shall be made immediately after 5,000 cycles.	接触抵抗: 200mΩ以下 その他、初期規格を満足すること。 Switch contact resistance: 200mΩ MAX. Except above items, specifications in clause 2. 1~4. and 3. 1~3 shall be satisfied.

△4.5 △5.4 △6

					ALPS ALPS ELECTRIC CO., LTD.		
		APPD.	CHKD.	DSGD.	TITLE PUSH MOMENTARY SWITCH プッシュモーメンタリスイッチ		
		設2 93.8-6 石川	W設2 92.7.28 溝淵	設2 93.7.28 三浦	DOCUMENT NO. 4LA2114-11 (/)		
△3	94.03.03	石川	溝淵	三浦			
SYMB	DATE	APPD	CHKD	DSGD			

OR

注記 軸受材質：亜鉛ダイキャスト
 軸材質：アルミニウム

NOTES BUSHING MATERIAL: ZINC ALLOY DIE CASTING
 SHAFT MATERIAL: ALUMINIUM

商標の向きは
任意とする。

THE DIRECTION
OF TRADE MARK
IS OPTIONAL.

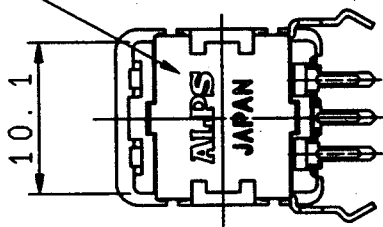

スリ割り角度は任意とする。
STROKE SLOT IS
OPTIONAL ANGLE

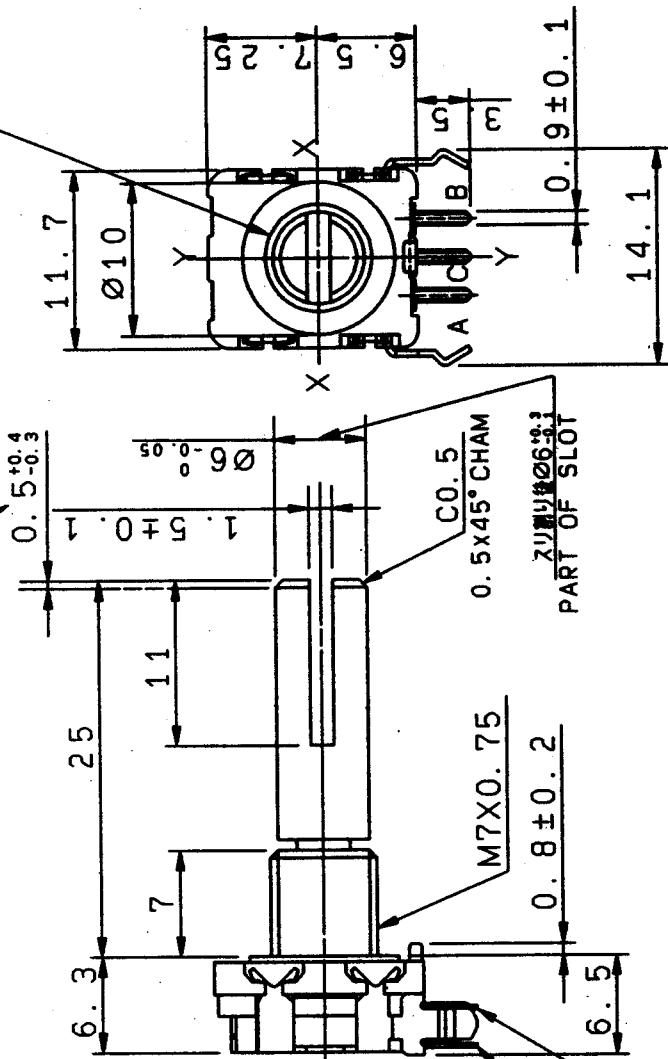

SW移動量

スリ割り後Ø6±0.1

0.5

1.5±0.1

0.5

7.25

6.5

6.5

0.9±0.1

14.1

11.7

Ø10

X

Y

A

B

C

L

S

取付穴寸法図 許容差±0.1 (挿入側より)

P.W.B. MOUNTING DETAIL
TOLERANCE±0.1
VIEWED FROM MOUNTING SIDE

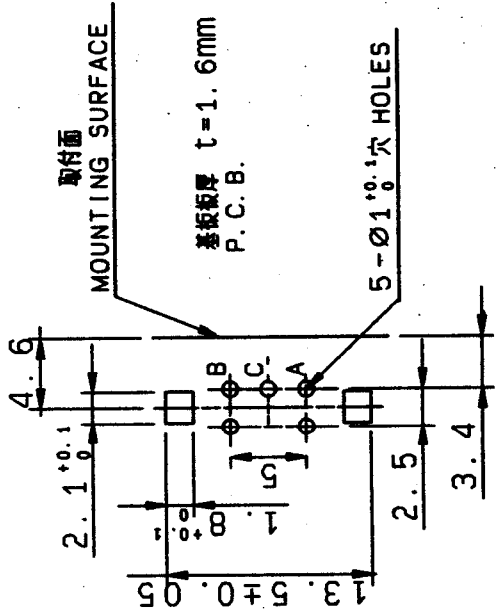

シャフト止めの詳細図
LOCATING LUG DETAIL

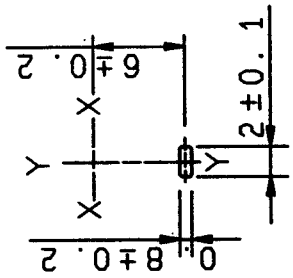

指定なき部分の許容差 TOLERANCES UNLESS OTHERWISE SPEC	L ≤ 10	±0.3
	10 < L < 100	±0.5
	100 < L	±0.8
角度 ANGULAR DIMENSION		±5°

PART NO.	NAME	MATERIAL NAME & CODE	FINISH
ALPS ELECTRIC CO., LTD.			
SYMB	DATE	APPD	CHKD
		94.11.16	94.11.16
		清湖	竹沢
		1-設2	1-設2
		94.11.15	三浦
		UNIT. mm	SCALE
		DSGD	TITLE 11形1軸 PUSH ON SW付薄形エンコーダ - DOCUMENT NO. LA2114229

OR

X-ON Electronics

Largest Supplier of Electrical and Electronic Components

Click to view similar products for [Encoders](#) category:

Click to view products by [ALPS](#) manufacturer:

Other Similar products are found below :

[6-1393048-5](#) [62AG22-H5-P](#) [62B22-LP-030C](#) [62D22-02-P](#) [62R22-01-040S](#) [63K25](#) [63K32](#) [63KS100](#) [63KS64](#) [63R100](#) [63R50-020](#) [63RS256-060](#) [700-09-36](#) [E6C2-CWZ6C-10 500P/R 5M](#) [E6C3-CWZ5GH 1000P/R 2M](#) [25LB22-G-Z](#) [T101-5C2-111-M1](#) [T101-5C3-111-M1](#) [T101-5C4-111-M1](#) [25LB45-Q-Z](#) [HEDS-8905](#) [385001M0439](#) [385001M0216](#) [DPL12SV2424A25K3](#) [E69-1](#) [E69-DF15](#) [E69-FBA-02](#) [E69-FCA](#) [E6B2-CWZ1X 2000P/R 0.5M](#) [E6B2-CWZ3E 600P/R 0.5M](#) [E6C3-CWZ3EH 800P/R 2M](#) [ENA1D-472-L00050L](#) [61S64-2](#) [62B11-LP-100S](#) [62B11-LPP-P](#) [62C1111-02-020C](#) [62N11-P](#) [62S22-H9-120S](#) [62S30-L0-200C](#) [62V15-02-080S](#) [62V22-02-030C](#) [632911-128](#) [63K64](#) [63KS100-040](#) [63R64-050](#) [63RS256](#) [63RS64](#) [700-16-16](#) [3-1393048-1](#) [63KS128](#)