

FEATURES

1. Low-profile, space-saving design (pitch: 0.3mm)

The 0.9mm height, 3.0mm depth contributes to the miniaturization and thickness reduction of target products.
* The total depth including the lever is 3.2mm.

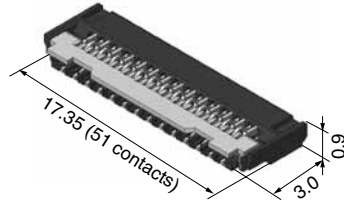

- 3. Equipped with soldering terminals for higher mounting strength
- 4. Easy-to-handle front lock structure
- 5. Wiring patterns can be located underneath the connector.
- 6. Ni barrier with high resistance to solder creep

APPLICATIONS

Compact mobile devices “Cellular phones, Digital cameras and DVC, etc”

2. Compatible with FPC without tabs, allowing smooth FPC insertion
Compatible with without FPC tabs, allowing smooth FPC insertion (Y3FT is compatible with FPC with tabs.)

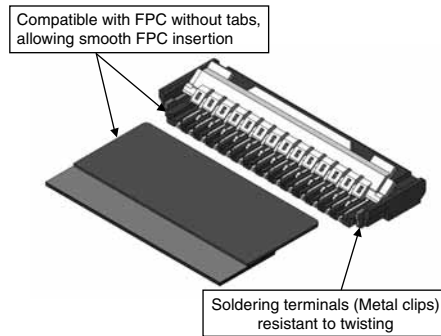

Compliance with RoHS Directive

ORDERING INFORMATION

AYF **3** **2** **1** **5**

32: FPC Connector 0.3 mm pitch
(Front lock, ZIF type without FPC tabs)

Number of contacts (2 digits)

Contact direction
1: Bottom contact

Surface treatment (Contact portion / Terminal portion)
5: Au plating/Au flash plating (Ni barrier)

PRODUCT TYPES

Height	Number of contacts	Part number	Packing	
			Inner carton	Outer carton
0.9 mm	15	AYF321515	5,000 pieces	10,000 pieces
	17	AYF321715		
	23	AYF322315		
	25	AYF322515		
	27	AYF322715		
	29	AYF322915		
	31	AYF323115		
	33	AYF323315		
	35	AYF323515		
	39	AYF323915		
	41	AYF324115		
	45	AYF324515		
	51	AYF325115		

Notes: 1. Order unit;

For mass production: in 1-inner carton (1-reel) units

Samples for mounting check: in 50-connector units. Please contact our sales office.

2. Please contact are sales office for connectors having a number of contacts other than those listed above.

SPECIFICATIONS

1. Characteristics

	Item	Specifications	Conditions
Electrical characteristics	Rated current	0.2A/contact	
	Rated voltage	50V AC/DC	
	Insulation resistance	Min. 1,000M Ω (initial)	Using 250V DC megger (applied for 1 min.)
	Breakdown voltage	150V AC for 1 min.	No short-circuiting or damage at a detection current of 1 mA when the specified voltage is applied for one minute.
	Contact resistance	Max. 80m Ω	Based on the contact resistance measurement method specified by JIS C 5402.
Mechanical characteristics	FPC holding force	Min. 0.13N/contacts \times contacts (initial)	Measurement of the maximum force applied until the inserted compatible FPC is pulled out in the insertion axis direction while the connector lever is closed
	Contact holding force	Min. 0.2N/contacts	Measuring the maximum force. As the contact is axially pull out.
	Soldering terminal holding force	Min. 0.2N/contacts	Measuring the maximum force. As the soldering terminal is axially pull out.
Environmental characteristics	Ambient temperature	-55°C to +85°C	No freezing at low temperatures. No dew condensation.
	Storage temperature	-55°C to +85°C (product only) -40°C to +50°C (emboss packing)	
	Thermal shock resistance (with FPC inserted)	5 cycles, insulation resistance min. 100M Ω , contact resistance max. 80m Ω	Sequence 1. -55 $\frac{3}{8}$ °C, 30 minutes 2. ~, Max. 5 minutes 3. 85 $\frac{3}{8}$ °C, 30 minutes 4. ~, Max. 5 minutes
	Humidity resistance (with FPC inserted)	120 hours, insulation resistance min. 100M Ω , contact resistance max. 80m Ω	Bath temperature 40 \pm 2°C, humidity 90 to 95% R.H.
	Saltwater spray resistance (with FPC inserted)	24 hours, insulation resistance min. 100M Ω , contact resistance max. 80m Ω	Bath temperature 35 \pm 2°C, saltwater concentration 5 \pm 1%
	H ₂ S resistance (with FPC inserted)	48 hours, contact resistance max. 80m Ω	Bath temperature 40 \pm 2°C, gas concentration 3 \pm 1 ppm, humidity 75 to 80% R.H.
	Soldering heat resistance	Peak temperature: 260°C or less 300°C within 5 sec. 350°C within 3 sec.	Reflow soldering Soldering iron
Lifetime characteristics	Insertion and removal life	30 times	Repeated insertion and removal: min. 10 sec./time
Unit weight		51-contact type: 0.09 g	

2. Material and surface treatment

Part name	Material	Surface treatment
Molded portion	Housing: LCP resin (UL94V-0) Lever: LCP resin (UL94V-0)	—
Contact	Copper alloy	Contact portion; Base: Ni plating, Surface: Au plating Terminal portion; Base: Ni plating, Surface: Au plating
Soldering terminal portion	Copper alloy	Base: Ni plating, Surface: Au plating

DIMENSIONS (Unit: mm)

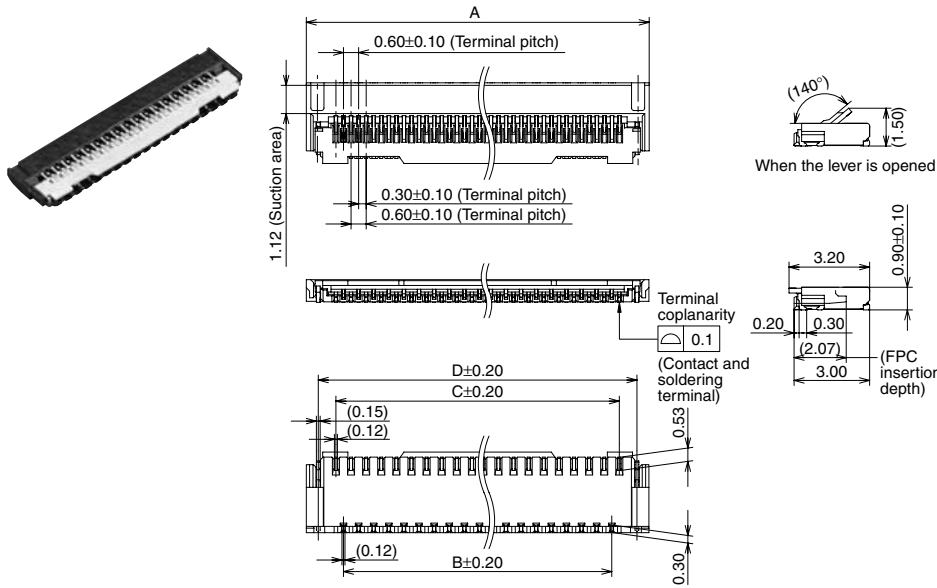

Number of contacts/ dimension	A	B	C	D
15	6.55	3.60	4.20	5.60
17	7.15	4.20	4.80	6.20
23	8.95	6.00	6.60	8.00
25	9.55	6.60	7.20	8.60
27	10.15	7.20	7.80	9.20
29	10.75	7.80	8.40	9.80
31	11.35	8.40	9.00	10.40
33	11.95	9.00	9.60	11.00
35	12.55	9.60	10.20	11.60
39	13.75	10.80	11.40	12.80
41	14.35	11.40	12.00	13.40
45	15.55	12.60	13.20	14.60
51	17.35	14.40	15.00	16.40

RECOMMENDED FPC DIMENSIONS

(Finished thickness: $t = 0.2 \pm 0.03$)

The conductive parts should be based by Ni plating and then Au plating.

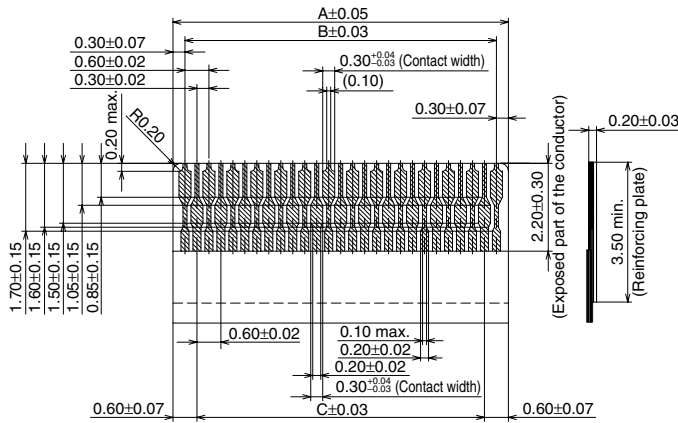

Number of contacts/ dimension	A	B	C
15	4.80	4.20	3.60
17	5.40	4.80	4.20
23	7.20	6.60	6.00
25	7.80	7.20	6.60
27	8.40	7.80	7.20
29	9.00	8.40	7.80
31	9.60	9.00	8.40
33	10.20	9.60	9.00
35	10.80	10.20	9.60
39	12.00	11.40	10.80
41	12.60	12.00	11.40
45	13.80	13.20	12.60
51	15.60	15.00	14.40

EMBOSSED TAPE DIMENSIONS (Unit: mm) (Common for respective contact type)

• Specifications for taping

(In accordance with JIS C 0806-1990. However, not applied to the mounting-hole pitch of some connectors.)

• Specifications for the plastic reel

(In accordance with EIAJ ET-7200B.)

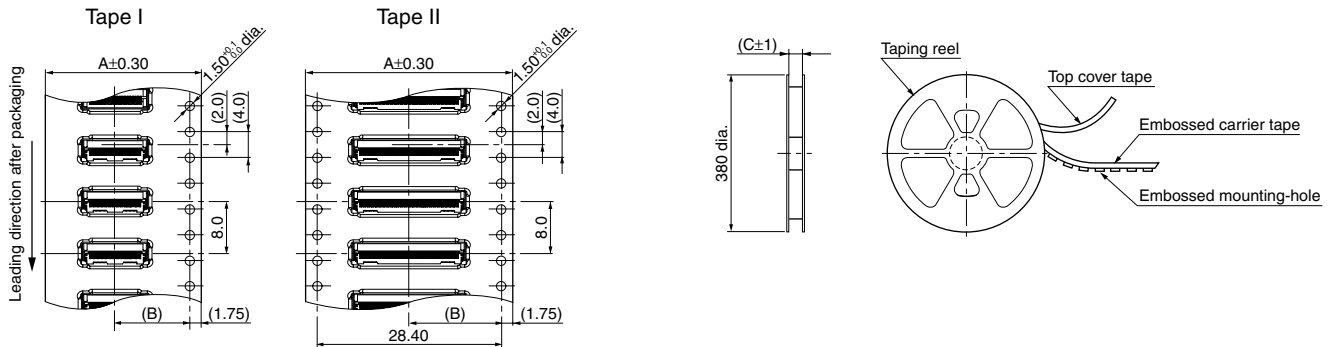

• Dimension table (Unit: mm)

Number of contacts	Type of taping	A	B	C	Quantity per reel
15 and 17 contacts	Tape I	16.0	7.5	17.4	5,000
23 to 45 contacts	Tape I	24.0	11.5	25.4	5,000
51 contacts	Tape II	32.0	14.2	33.4	5,000

• Connector orientation with respect to embossed tape feeding direction

Direction of tape progress ↓	Type Y3F	
---------------------------------	-------------	--

NOTES

1. Recommended PC board and metal mask patterns

Appropriate control of solder amount is required to minimize solder bridges and other defects for connectors with 0.3 mm, 0.4 mm or 0.5 mm pitch terminals, which require high-density mounting. Refer to the recommended PC board pattern.

Recommended PC board pattern (Mount pad arrangement pattern)

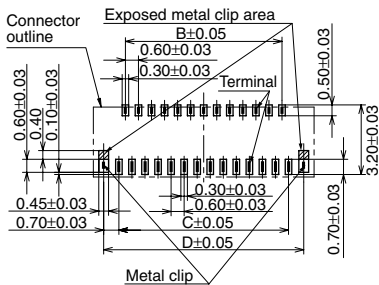

Number of contacts/ dimension	B	C	D
15	3.60	4.20	5.60
17	4.20	4.80	6.20
23	6.00	6.60	8.00
25	6.60	7.20	8.60
27	7.20	7.80	9.20
29	7.80	8.40	9.80
31	8.40	9.00	10.40
33	9.00	9.60	11.00
35	9.60	10.20	11.60
39	10.80	11.40	12.80
41	11.40	12.00	13.40
45	12.60	13.20	14.60
51	14.40	15.00	16.40

2. Precautions for insertion/removal of FPC

To open the lever, hold its center and turn it up. A load applied to the lever unevenly or on only one side may deform and break the lever. Do not apply an excessive load to the lever in the opening direction; otherwise, the terminals may be deformed. Don't further apply an excessive load to the fully opened lever; otherwise, the lever may be deformed. Fully open the lever to insert an FPC. Since this product connects at the bottom, please insert the FPC so that its electrode plane is facing the board to which it will be mounted. Do not insert the FPC in the reverse direction of the contact section; otherwise, operation failures or malfunctions may be caused.

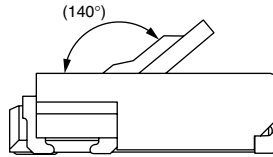

Completely insert the FPC horizontally. An FPC inserted at an excessive angle to the board may cause the deformation of metal parts, FPC insertion failures, and FPC circuit breakages.

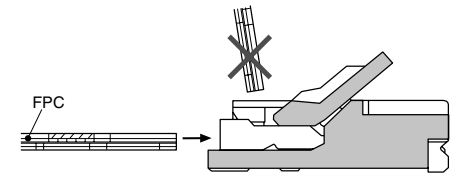

Insert the FPC to the full depth of the connector without altering the angle. When closing the lever, use the ball(s) of your finger to push the entire lever or both sides of it. Be careful. If pressure to the lever is applied unevenly, such as to an edge only, it may deform or break. Also, make sure that the lever is closed completely. Not doing so will cause a faulty connection. Avoid applying an excessive load to the top of the lever during or after closing the lever. Otherwise, the terminals may be deformed. Remove the FPC at parallel with the lever fully opened. If the lever is closed, or if the FPC is forcedly pulled, the molded part may break. After an FPC is inserted, carefully handle it so as not to apply excessive stress to the base of the FPC.

For other details, please verify with the product specification sheets.

FPC CONNECTORS COMMON CAUTIONS FOR USE

COMMON CAUTIONS FOR USE

■ PC board design

Design the recommended foot pattern in order to secure the mechanical strength in the soldered areas of the terminal.

■ FPC and equipment design

Design the FPC based on the recommended dimensions to ensure the required connector performance.

In addition, carefully check the equipment design and take required measures for the equipment to prevent the FPC from being removed subsequent to a fall, vibration, or other impact due to the FPC size, weight, or the reaction force of the routed FPC.

■ Connector mounting

In case the connector is picked up by chucking during mounting, an excessive moulder chucking force may deform the molded or metal part of the connector. Consult us in advance if chucking is to be applied.

■ Soldering

1) Manual soldering.

• Due to the low profile, if an excessive amount of solder is applied to this product during manual soldering, the solder may creep up to near the contact points, or interference by solder may cause imperfect contact.

• Make sure that the soldering iron tip is heated within the temperature and time limits indicated in the specifications.

• Flux from the solder wire may adhere to the contact surfaces during soldering operations. After soldering, carefully check the contact surfaces and clean off any flux before use.

• Be aware that a load applied to the connector terminals while soldering may displace the contact.

• Thoroughly clean the iron tip.

2) Reflow soldering

• Screen-printing is recommended for printing paste solder.

Y3FT/Y3F/Y3B

To determine the relationship between the screen opening area and the PC board foot pattern area, refer to the diagrams in the recommended patterns for PC boards and metal masks when setting.

Note that excess solder on the terminals prevents complete insertion of the FPC, and that excess solder on the metal clips prevents the lever from rotating.

Y5S

Note that excess solder inhibits the slider lock operation.

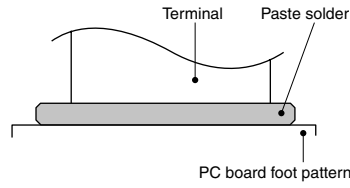

- Screen thickness of 120 μ m is recommended for paste solder printing.
- Consult us when using a screen-printing thickness other than that recommended.
- Depending on the size of the connector being used, self alignment may not be possible. Accordingly, carefully position the terminal with the PC board pattern.
- The recommended reflow temperature profile is given in the figure below

Recommended reflow temperature profile

Y3FT/Y3F/Y3B

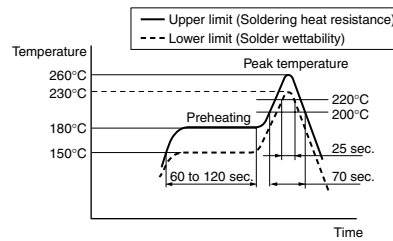

Y5S

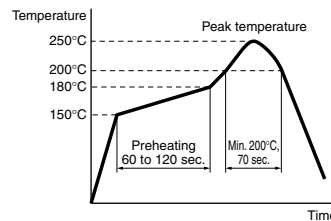

Y5F

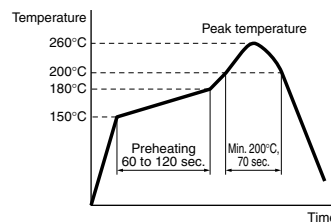

- The temperature is measured on the surface of the PC board near the connector terminal.
- Some solder and flux types may cause serious solder creeping. Take the solder and flux characteristics into consideration when setting the reflow soldering conditions.

• When performing reflow soldering on the back of the PC board after reflow soldering the connector, secure the connector using, for example, an adhesive. (Double reflow soldering on the same side is possible)

3) Reworking on a soldered portion

• Finish reworking in one operation.

• For reworking of the solder bridge, use a soldering iron with a flat tip. Do not add flux, otherwise, the flux may creep to the contact parts.

• Use a soldering iron whose tip temperature is within the temperature range specified in the specifications.

■ **Do not drop the product or handle carelessly. Otherwise, the terminals may become deformed due to excessive force or the solderability during reflow soldering may degrade.**

■ **Don't open/close the lever or insert/remove an FPC until the connector is soldered. Forcibly applied external pressure on the terminals can weaken the adherence of the terminals to the molded part or cause the terminals to lose their evenness. In addition, do not insert an FPC into the connector before soldering the connector.**

■ **When cutting or bending the PC board after mounting the connector, be careful that the soldered sections are subjected to excessive forces.**

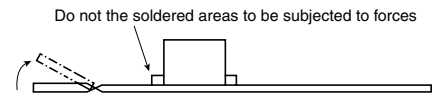

■ Other Notes

When coating the PC board after soldering the connector to prevent the deterioration of insulation, perform the coating in such a way so that the coating does not get on the connector.

The connectors are not meant to be used for switching.

For other details, please verify with the product specification sheets.

X-ON Electronics

Largest Supplier of Electrical and Electronic Components

Click to view similar products for [FFC & FPC Connectors](#) category:

Click to view products by [Panasonic](#) manufacturer:

Other Similar products are found below :

[HFW11R-1STE1H1LF](#) [FH29B-100S-0.2SHW\(99\)](#) [FA5S008HP1](#) [FH29B-120S-0.2SHW\(99\)](#) [FH29B-80S-0.2SHW\(99\)](#) [FHS-16](#) [FPH-2022G](#)
[52610-1075](#) [52610-1275](#) [52610-1934](#) [XF3M\(1\)-1415-1B-R100](#) [501864-3091-TR225](#) [0525594033](#) [086210010340800](#) [086222026001800](#)
[52271-2869-CUT-TAPE](#) [62674-201121DLF](#) [62684-36210E9ALF](#) [52610-1675](#) [52746-1671-TR250](#) [10051922-2810EHLF](#) [6-520415-9](#)
[BD021-09A-A1-0350-0200-0550-LD](#) [SFV6R-1STE9HLF](#) [XF3M-2915-1B-R100](#) [1658549-1](#) [62674-221121ALF](#) [46214008010800](#)
[046298003000883](#) [151660622](#) [842-816-2630-035](#) [AYF530665TA](#) [AYF351525](#) [046296011930846+](#) [AYF352325A](#) [046254020000800+](#)
[FH19C-13S-0.5SH\(99\)](#) [FH39J-51S-0.3SHW\(99\)](#) [AYF355125A](#) [AYF530365TA](#) [FH29B-44S-0.2SHW\(99\)](#) [SFW5R-2STAE9LF](#) [AYF351125A](#)
[AYF350725A](#) [62684-502100AHLF](#) [FH39-61S-0.3SHW\(99\)](#) [AYF414035A](#) [10064555-172520HLF](#) [AYF212335A](#) [504754-2500](#)