

T140 Series Axial MIL-PRF-39003 Polar Type and T242 (CSR23 Style)

Overview

The KEMET standard MIL case hermetically sealed T140 Series (Extended Capacitance Range) is compact, ruggedly built and designed for miniaturized circuitry. The capacitors are especially well-suited for coupling, bypass filtering and RC timing circuits. The T140 Series exhibits excellent stability, low DC leakage

current, dissipation factor, and ESR/impedance over a wide temperature and frequency range. Available in standard EIA capacitance values from 0.82 μF to 1,200 μF in $\pm 20\%$ and $\pm 10\%$ tolerances and working voltages of 6 VDC to 60 VDC.

Benefits

- Taped and reeled per EIA Specification RS-296
- Marking per MIL-STD-1285
- Qualified to MIL-PRF-39003 (CSR23 Style)
- Failure rate options: Graded - B, C, D and G
Exponential - M, P, R, and S*
- Capacitance values of 0.82 μF to 1200 μF
- Tolerances of $\pm 10\%$ and $\pm 20\%$
- Voltage rating of 6 VDC–60 VDC
- Operating temperature range of -55°C to $+125^{\circ}\text{C}$
- Case sizes: A, B, C, D

*Failure rates apply to military products only



Applications

Typical applications include coupling, bypass, filtering and RC timing circuits in miniaturized circuitry.

Ordering Information – T140

T	140	A	105	K	050	A	S	7200
Capacitor Class	Series	Case Size	Capacitance Code (pF)	Capacitance Tolerance	Rated Voltage (VDC)	Failure Rate/Military Product Only	Termination Finish	Specification
T = Tantalum	Hermetically Sealed Axial Capacitor	A, B, C, D	First two digits represent significant figures. Third digit specifies number of zeros.	K = ±10% M = ±20%	006 = 6 010 = 10 015 = 15 020 = 20 030 = 30 035 = 35 060 = 60 050 = 50 060 = 60	A = N/A	S = Standard (Sn/Pb) T = 100% Tin	All capacitors are sleeved unless specified. 0100 = Without sleeve 7200 = Tape & Reel 7293 & 7443 = Ammo 4250 = 10 cycles, 25°C after Weibull 4251 = 10 cycles, -55 & 85°C after Weibull 4252 = 10 cycles, -55 & 85°C before Weibull

Ordering Information – T242 (CSR23 Style)

T	242	A	105	K	050	A	S	C
Capacitor Class	Series	Case Size	Capacitance Code (pF)	Capacitance Tolerance	Rated Voltage (VDC)	Failure Rate/Military Product Only	Termination Finish	Specification
T = Tantalum	T242 = CSR23	A, B, C, D	First two digits represent significant figures. Third digit specifies number of zeros.	K = ±10% M = ±20%	006 = 6 010 = 10 015 = 15 020 = 20 030 = 30 035 = 35 060 = 60 050 = 50 060 = 60	Graded: B = 0.1%/k hours C = 0.01%/k hours D = 0.001%/k hours G = 1.0%/k hours Exponential: M = 1%/k hours P = 0.1%/k hours R = 0.01%/k hours S = 0.001%/k hours	S = Standard	All capacitors are sleeved unless specified. 0100 = Without sleeve 7200 = Tape & Reel 7293 & 7443 = Ammo 4250 = 10 cycles, 25°C after Weibull 4251 = 10 cycles, -55 & 85°C after Weibull 4252 = 10 cycles, -55 & 85°C before Weibull

Ordering Information – MIL-PRF 39003

M39003	/03	3075	A
Capacitor Class	Slash	Dash Number	Surge Option
Military Specification Number	Specification Sheet Number	Failure Rate Level	A = C-4250 B = C-4251 C = C-4252 Blank - No surge

Orders should be entered by the military specification number, including the dash number and surge option letter (A, B or C).

Performance Characteristics

Item	Performance Characteristics
Operating Temperature	-55°C to 125°C
Rated Capacitance Range	0.82 – 1,200 µF at 120 Hz/25°C
Capacitance Tolerance	K Tolerance (10%), M Tolerance (20%)
Rated Voltage Range	6 – 60 V
DF (120 Hz at 25°C)	Refer to Part Number Electrical Specification Table
ESR and Impedance (100 kHz at 25°C)	Refer to Part Number Electrical Specification Table (for reference only)
Leakage Current	Refer to Part Number Electrical Specification Table (at rated voltage up to +85°C and 2/3 of rated voltage applied at 125°C)
Failure Rate (MIL-39003, CSR13 capacitors only)	Approved failure rate: S (0.001%/k hours) - Exponential, D (0.001%/k hours) - Graded

Dimensions – Inches (Millimeters)

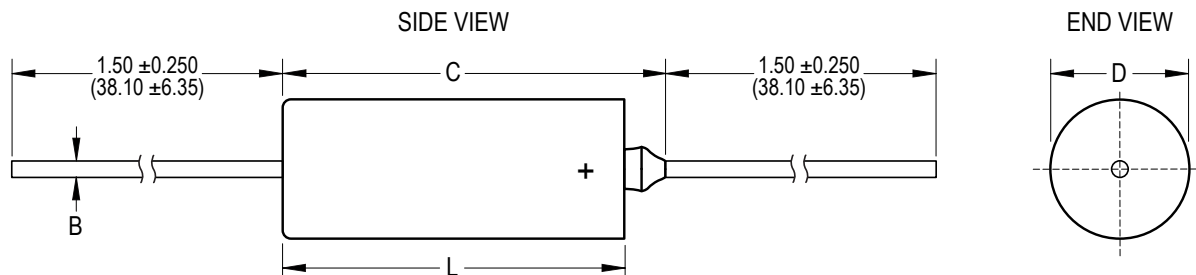

Case Size	Uninsulated		Insulated		B ±0.002 ±(0.05)	C Maximum
	D ±0.005 ±(0.13)	L ±0.031 ±(0.79)	D ±0.010 ±(0.25)	L ±0.031 ±(0.79)		
A	0.125 (3.18)	0.250 (6.35)	0.135 (3.43)	0.286 (7.26)	0.020 (0.51)	0.422 (10.72)
B	0.175 (4.45)	0.438 (11.13)	0.185 (4.70)	0.474 (12.04)	0.020 (0.51)	0.610 (15.49)
C	0.279 (7.09)	0.650 (16.51)	0.289 (7.34)	0.686 (17.42)	0.025 (0.64)	0.822 (20.88)
D	0.341 (8.66)	0.750 (19.05)	0.351 (8.92)	0.786 (19.96)	0.025 (0.64)	0.922 (23.42)

Table 1 – Ratings & Part Number Reference

Rated Voltage	Rated Cap	Case Size Code	KEMET Part Number	DC Leakage	DF % at 25°C	MIL-PRF-39003 (CSR23) Capacitors										KEMET Equivalent Military		
						Dash Number Reference												
						Failure Rate Level (%/1,000 Hours)												
						MIL-PRF-39003/3F				MIL-PRF-39003/3F								
						Exponential				Graded								
VDC	µF		(See below for part options)	µA at 25°C Max/5 Minutes	120 Hz Maximum	M (1.0)	P (0.1)	R (0.01)	S (0.001)	G (1)	B (0.1)	C (0.01)	D (0.001)	Part Number				
6	8.2	A	T140A825(1)006A(3)	0.9	6													
6	10.0	A	T140A106K006A(3)	0.9	6	0101	0201	0301	0401	5001	2001	3001	4001	T242A106K006(2)S				
6	10.0	A	T140A106M006A(3)	0.9	6	0102	0202	0302	0402	5002	2002	3002	4002	T242A106M006(2)S				
6	12.0	A	T140A126K006A(3)	1.0	6	0103	0203	0303	0403	5003	2003	3003	4003	T242A126K006(2)S				
6	12.0	A	T140A126M006A(3)	1.0	6													
6	68.0	B	T140B686(1)006A(3)	3.0	6													
6	82.0	B	T140B826(1)006A(3)	3.0	6													
6	100.0	B	T140B107K006A(3)	6.0	6	0104	0204	0304	0404	5004	2004	3004	4004	T242B107K006(2)S				
6	100.0	B	T140B107M006A(3)	6.0	6	0105	0205	0305	0405	5005	2005	3005	4005	T242B107M006(2)S				
6	220.0	C	T140C227(1)006A(3)	10.0	8													
6	270.0	C	T140C277(1)006A(3)	10.0	8													
6	330.0	C	T140C337K006A(3)	10.0	8	0106	0206	0306	0406	5006	2006	3006	4006	T242C337K006(2)S				
6	330.0	C	T140C337M006A(3)	10.0	8	0107	0207	0307	0407	5007	2007	3007	4007	T242C337M006(2)S				
6	390.0	C	T140C397K006A(3)	10.0	10	0108	0208	0308	0408	5008	2008	3008	4008	T242C397K006(2)S				
6	390.0	C	T140C397M006A(3)	10.0	10													
6	470.0	C	T140C477K006A(3)	10.0	10	0109	0209	0309	0409	5009	2009	3009	4009	T242C477K006(2)S				
6	470.0	C	T140C477M006A(3)	10.0	10	0110	0210	0310	0410	5010	2010	3010	4010	T242C477M006(2)S				
6	560.0	D	T140D567(1)006A(3)	20.0	10													
6	680.0	D	T140D687K006A(3)	20.0	10	0111	0211	0311	0411	5011	2011	3011	4011	T242D687K006(2)S				
6	680.0	D	T140D687M006A(3)	20.0	10	0112	0212	0312	0412	5012	2012	3012	4012	T242D687M006(2)S				
6	820.0	D	T140D827K006A(3)	20.0	10	0113	0213	0313	0413	5013	2013	3013	4013	T242D827K006(2)S				
6	820.0	D	T140D827M006A(3)	20.0	10													
6	1000.0	D	T140D108K006A(3)	20.0	10	0114	0214	0314	0414	5014	2014	3014	4014	T242D108K006(2)S				
6	1000.0	D	T140D108M006A(3)	20.0	10	0115	0215	0315	0415	5015	2015	3015	4015	T242D108M006(2)S				
6	1200.0	D	T140D128M006A(3)	20.0	10													
10	5.6	A	T140A565(1)010A(3)	1.0	4													
10	6.8	A	T140A685K010A(3)	1.0	6	0116	0216	0316	0416	5016	2016	3016	4016	T242A685K010(2)S				
10	6.8	A	T140A685M010A(3)	1.0	6	0117	0217	0317	0417	5017	2017	3017	4017	T242A685M010(2)S				
10	8.2	A	T140A825K010A(3)	1.2	6	0118	0218	0318	0418	5018	2018	3018	4018	T242A825K010(2)S				
10	8.2	A	T140A825M010A(3)	1.2	6													
10	47.0	B	T140B476K010A(3)	4.0	6	0119	0219	0319	0419	5019	2019	3019	4019	T242B476K010(2)S				
10	47.0	B	T140B476M010A(3)	4.0	6	0120	0220	0320	0420	5020	2020	3020	4020	T242B476M010(2)S				
10	56.0	B	T140B566K010A(3)	5.0	6	0121	0221	0321	0421	5021	2021	3021	4021	T242B566K010(2)S				
10	56.0	B	T140B566M010A(3)	5.0	6													
10	68.0	B	T140B686K010A(3)	6.0	6	0122	0222	0322	0422	5022	2022	3022	4022	T242B686K010(2)S				
10	68.0	B	T140B686M010A(3)	6.0	6	0123	0223	0323	0423	5023	2023	3023	4023	T242B686M010(2)S				
10	82.0	B	T140B826K010A(3)	7.0	6	0124	0224	0324	0424	5024	2024	3024	4024	T242B826K010(2)S				
10	82.0	B	T140B826M010A(3)	7.0	6													
10	150.0	C	T140C157(1)010A(3)	8.0	8													
10	180.0	C	T140C187(1)010A(3)	8.0	8													
10	220.0	C	T140C227K010A(3)	12.0	8	0125	0225	0325	0425	5025	2025	3025	4025	T242C227K010(2)S				
10	220.0	C	T140C227M010A(3)	12.0	8	0126	0226	0326	0426	5026	2026	3026	4026	T242C227M010(2)S				
10	270.0	C	T140C277K010A(3)	13.0	8	0127	0227	0327	0427	5027	2027	3027	4027	T242C277K010(2)S				
10	270.0	C	T140C277M010A(3)	13.0	8													
10	330.0	D	T140D337(1)010A(3)	16.0	8													
10	390.0	D	T140D397K010A(3)	16.0	10	0128	0228	0328	0428	5028	2028	3028	4028	T242D397K010(2)S				
10	390.0	D	T140D397M010A(3)	16.0	10													
10	470.0	D	T140D477K010A(3)	16.0	10	0129	0229	0329	0429	5029	2029	3029	4029	T242D477K010(2)S				
VDC	µF		(See below for part options)	µA at 25°C Max/5 Minutes	120 Hz Maximum	M (1.0)	P (0.1)	R (0.01)	S (0.001)	G (1)	B (0.1)	C (0.01)	D (0.001)	Part Number				
Rated Voltage	Rated Cap	Case Size Code	KEMET Part Number	DC Leakage	DF % at 25°C	MIL-PRF-39003 (CSR23) Capacitors												

(1) To complete KEMET part number, insert M for ±20% or K for ± 10%. Designates capacitance tolerance.
(2) To complete KEMET part number (T242), insert failure rate code from Ordering Information table.
(3) To complete KEMET T140 Part Number, insert Lead Material designator: S – Standard or T – 100% Matte Tin. Designates termination finish.

Table 1 – Ratings & Part Number Reference cont'd

Rated Voltage	Rated Cap	Case Size Code	KEMET Part Number	DC Leakage	DF % at 25°C	MIL-PRF-39003 (CSR23) Capacitors										KEMET Equivalent Military		
						Dash Number Reference								Failure Rate Level (%/1,000 Hours)				
						MIL-PRF-39003/3F				MIL-PRF-39003/3F								
						Exponential				Graded								
						VDC	µF	(See below for part options)	µA at 25°C Max/5 Minutes	120 Hz Maximum	M (1.0)	P (0.1)	R (0.01)	S (0.001)	G (1)		B (0.1)	C (0.01)
10	470.0	D	T140D477M010A(3)	16.0	10	0130	0230	0330	0430	5030	2030	3030	4030	T242D477M010(2)S				
10	560.0	D	T140D567K010A(3)	20.0	10	0131	0231	0331	0431	5031	2031	3031	4031	T242D567K010(2)S				
10	560.0	D	T140D567M010A(3)	20.0	10													
15	3.9	A	T140A395(1)015A(3)	1	4													
15	4.7	A	T140A475K015A(3)	1	4	0132	0232	0332	0432	5032	2032	3032	4032	T242A475K015(2)S				
15	4.7	A	T140A475M015A(3)	1	4	0133	0233	0333	0433	5033	2033	3033	4033	T242A475M015(2)S				
15	5.6	A	T140A565K015A(3)	1.3	4	0134	0234	0334	0434	5034	2034	3034	4034	T242A565K015(2)S				
15	5.6	A	T140A565M015A(3)	1.3	4													
15	27.0	B	T140B276(1)015A(3)	3	6													
15	33.0	B	T140B336K015A(3)	5	6	0135	0235	0335	0435	5035	2035	3035	4035	T242B336K015(2)S				
15	33.0	B	T140B336M015A(3)	5	6	0136	0236	0336	0436	5036	2036	3036	4036	T242B336M015(2)S				
15	39.0	B	T140B396K015A(3)	5.3	6	0137	0237	0337	0437	5037	2037	3037	4037	T242B396K015(2)S				
15	39.0	B	T140B396M015A(3)	5.3	6													
15	82.0	C	T140C826(1)015A(3)	8	6													
15	100.0	C	T140C107(1)015A(3)	10	6													
15	120.0	C	T140C127(1)015A(3)	10	6													
15	150.0	C	T140C157K015A(3)	15	8	0138	0238	0338	0438	5038	2038	3038	4038	T242C157K015(2)S				
15	150.0	C	T140C157M015A(3)	15	8	0139	0239	0339	0439	5039	2039	3039	4039	T242C157M015(2)S				
15	180.0	C	T140C187K015A(3)	15	8	0140	0240	0340	0440	5040	2040	3040	4040	T242C187K015(2)S				
15	180.0	C	T140C187M015A(3)	15	8													
15	220.0	D	T140D227K015A(3)	20	8	0141	0241	0341	0441	5041	2041	3041	4041	T242D227K015(2)S				
15	220.0	D	T140D227M015A(3)	20	8	0142	0242	0342	0442	5042	2042	3042	4042	T242D227M015(2)S				
15	270.0	D	T140D277K015A(3)	20	8	0143	0243	0343	0443	5043	2043	3043	4043	T242D277K015(2)S				
15	270.0	D	T140D277M015A(3)	20	8													
15	330.0	D	T140D337K015A(3)	20	8	0144	0244	0344	0444	5044	2044	3044	4044	T242D337K015(2)S				
15	330.0	D	T140D337M015A(3)	20	8	0145	0245	0345	0445	5045	2045	3045	4045	T242D337M015(2)S				
20	2.7	A	T140A275K020A(3)	0.8	4	0146	0246	0346	0446	5046	2046	3046	4046	T242A275K020(2)S				
20	2.7	A	T140A275M020A(3)	0.8	4													
20	3.3	A	T140A335K020A(3)	1.0	4	0147	0247	0347	0447	5047	2047	3047	4047	T242A335K020(2)S				
20	3.3	A	T140A335M020A(3)	1.0	4	0148	0248	0348	0448	5048	2048	3048	4048	T242A335M020(2)S				
20	3.9	A	T140A395K020A(3)	1.2	4	0149	0249	0349	0449	5049	2049	3049	4049	T242A395K020(2)S				
20	3.9	A	T140A395M020A(3)	1.2	4													
20	18.0	B	T140B186K020A(3)	3.0	6	0150	0250	0350	0450	5050	2050	3050	4050	T242B186K020(2)S				
20	18.0	B	T140B186M020A(3)	3.0	6													
20	22.0	B	T140B226K020A(3)	3.0	6	0151	0251	0351	0451	5051	2051	3051	4051	T242B226K020(2)S				
20	22.0	B	T140B226M020A(3)	3.0	6	0152	0252	0352	0452	5052	2052	3052	4052	T242B226M020(2)S				
20	27.0	B	T140B276K020A(3)	4.0	6	0153	0253	0353	0453	5053	2053	3053	4053	T242B276K020(2)S				
20	27.0	B	T140B276M020A(3)	4.0	6													
20	56.0	C	T140C566K020A(3)	7.0	6	0154	0254	0354	0454	5054	2054	3054	4054	T242C566K020(2)S				
20	56.0	C	T140C566M020A(3)	7.0	6													
20	68.0	C	T140C686K020A(3)	8.0	6	0155	0255	0355	0455	5055	2055	3055	4055	T242C686K020(2)S				
20	68.0	C	T140C686M020A(3)	8.0	6	0156	0256	0356	0456	5056	2056	3056	4056	T242C686M020(2)S				
20	82.0	C	T140C826K020A(3)	10.0	6	0157	0257	0357	0457	5057	2057	3057	4057	T242C826K020(2)S				
20	82.0	C	T140C826M020A(3)	10.0	6													
20	100.0	C	T140C107K020A(3)	12.0	6	0158	0258	0358	0458	5058	2058	3058	4058	T242C107K020(2)S				
20	100.0	C	T140C107M020A(3)	12.0	6	0159	0259	0359	0459	5059	2059	3059	4059	T242C107M020(2)S				
20	120.0	C	T140C127K020A(3)	12.0	6	0160	0260	0360	0460	5060	2060	3060	4060	T242C127K020(2)S				
20	120.0	C	T140C127M020A(3)	12.0	6													
Rated Voltage	Rated Cap	Case Size Code	(See below for part options)	µA at 25°C Max/5 Minutes	120 Hz Maximum	M (1.0)	P (0.1)	R (0.01)	S (0.001)	G (1)	B (0.1)	C (0.01)	D (0.001)	Part Number				
Rated Voltage	Rated Cap	Case Size Code	KEMET Part Number	DC Leakage	DF % at 25°C	MIL-PRF-39003 (CSR23) Capacitors												

(1) To complete KEMET part number, insert M for ±20% or K for ± 10%. Designates capacitance tolerance.
 (2) To complete KEMET part number (T242), insert failure rate code from Ordering Information table.
 (3) To complete KEMET T140 Part Number, insert Lead Material designator: S – Standard or T – 100% Matte Tin. Designates termination finish.

Table 1 – Ratings & Part Number Reference cont'd

Rated Voltage	Rated Cap	Case Size Code	KEMET Part Number	DC Leakage	DF % at 25°C	MIL-PRF-39003 (CSR23) Capacitors										KEMET Equivalent Military		
						Dash Number Reference												
						Failure Rate Level (%/1,000 Hours)												
						MIL-PRF-39003/3F				MIL-PRF-39003/3F								
						Exponential				Graded								
VDC	µF		(See below for part options)	µA at 25°C Max/5 Minutes	120 Hz Maximum	M (1.0)	P (0.1)	R (0.01)	S (0.001)	G (1)	B (0.1)	C (0.01)	D (0.001)	Part Number				
20	150.0	D	T140D157K020A(3)	15.0	8	0161	0261	0361	0461	5061	2061	3061	4061	T242D157K020(2)S				
20	150.0	D	T140D157M020A(3)	15.0	8	0162	0262	0362	0462	5062	2062	3062	4062	T242D157M020(2)S				
20	180.0	D	T140D187K020A(3)	15.0	8	0163	0263	0363	0463	5063	2063	3063	4063	T242D187K020(2)S				
20	180.0	D	T140D187M020A(3)	15.0	8													
30	1.2	A	T140A125(1)030A(3)	1.0	4													
30	1.5	A	T140A155(1)030A(3)	1.0	4													
30	1.8	A	T140A185(1)030A(3)	1.0	4													
30	2.2	A	T140A225(1)030A(3)	1.0	4													
30	2.7	A	T140A275(1)030A(3)	1.0	4													
30	12.0	B	T140B126(1)030A(3)	3.0	4													
30	15.0	B	T140B156(1)030A(3)	3.0	4													
30	18.0	B	T140B186(1)030A(3)	3.0	4													
30	33.0	C	T140C336(1)030A(3)	6.0	6													
30	39.0	C	T140C396(1)030A(3)	6.0	6													
30	47.0	C	T140C476(1)030A(3)	7.0	6													
30	56.0	C	T140C566(1)030A(3)	7.0	6													
30	68.0	C	T140C686(1)030A(3)	7.0	6													
30	82.0	D	T140D826(1)030A(3)	10.0	6													
30	100.0	D	T140D107(1)030A(3)	10.0	8													
35	1.2	A	T140A125(1)035A(3)	0.6	4													
35	1.5	A	T140A155(1)035A(3)	0.8	4													
35	1.8	A	T140A185K035A(3)	1.0	4	0164	0264	0364	0464	5064	2064	3064	4064	T242A185K035(2)S				
35	1.8	A	T140A185M035A(3)	1.0	4													
35	8.2	B	T140B825K035A(3)	3.0	4	0165	0265	0365	0465	5065	2065	3065	4065	T242B825K035(2)S				
35	8.2	B	T140B825M035A(3)	3.0	4													
35	10.0	B	T140B106K035A(3)	3.0	4	0166	0266	0366	0466	5066	2066	3066	4066	T242B106K035(2)S				
35	10.0	B	T140B106M035A(3)	3.0	4	0167	0267	0367	0467	5067	2067	3067	4067	T242B106M035(2)S				
35	27.0	C	T140C276(1)035A(3)	7.0	6													
35	33.0	C	T140C336K035A(3)	8.0	6	0168	0268	0368	0468	5068	2068	3068	4068	T242C336K035(2)S				
35	33.0	C	T140C336M035A(3)	8.0	6	0169	0269	0369	0469	5069	2069	3069	4069	T242C336M035(2)S				
35	39.0	C	T140C396K035A(3)	10.0	6	0170	0270	0370	0470	5070	2070	3070	4070	T242C396K035(2)S				
35	39.0	C	T140C396M035A(3)	10.0	6													
35	47.0	C	T140C476K035A(3)	10.0	6	0171	0271	0371	0471	5071	2071	3071	4071	T242C476K035(2)S				
35	47.0	C	T140C476M035A(3)	10.0	6	0172	0272	0372	0472	5072	2072	3072	4072	T242C476M035(2)S				
35	56.0	D	T140D566K035A(3)	12.0	6	0173	0273	0373	0473	5073	2073	3073	4073	T242D566K035(2)S				
35	56.0	D	T140D566M035A(3)	12.0	6													
35	68.0	D	T140D686K035A(3)	12.0	6	0174	0274	0374	0474	5074	2074	3074	4074	T242D686K035(2)S				
35	68.0	D	T140D686M035A(3)	12.0	6	0175	0275	0375	0475	5075	2075	3075	4075	T242D686M035(2)S				
35	82.0	D	T140D826(1)035A(3)	20.0	8													
35	100.0	D	T140D107(1)035A(3)	20.0	8													
50	1.2	A	T140A125K050A(3)	0.6	4	0176	0276	0376	0476	5076	2076	3076	4076	T242A125K050(2)S				
50	1.2	A	T140A125M050A(3)	0.6	4													
50	1.5	A	T140A155K050A(3)	0.8	4	0177	0277	0377	0477	5077	2077	3077	4077	T242A155K050(2)S				
50	1.5	A	T140A155M050A(3)	0.8	4	0178	0278	0378	0478	5078	2078	3078	4078	T242A155M050(2)S				
50	5.6	B	T140B565K050A(3)	2.5	4	0179	0279	0379	0479	5079	2079	3079	4079	T242B565K050(2)S				
50	5.6	B	T140B565M050A(3)	2.5	4													
50	6.8	B	T140B685K050A(3)	2.5	4	0180	0280	0380	0480	5080	2080	3080	4080	T242B685K050(2)S				
50	6.8	B	T140B685M050A(3)	2.5	4	0181	0281	0381	0481	5081	2081	3081	4081	T242B685M050(2)S				
VDC	µF	Case Size Code	(See below for part options)	µA at 25°C Max/5 Minutes	120 Hz Maximum	M (1.0)	P (0.1)	R (0.01)	S (0.001)	G (1)	B (0.1)	C (0.01)	D (0.001)	Part Number				
Rated Voltage	Rated Cap	Case Size Code	KEMET Part Number	DC Leakage	DF % at 25°C	MIL-PRF-39003 (CSR23) Capacitors												

(1) To complete KEMET part number, insert M for ±20% or K for ± 10%. Designates capacitance tolerance.
(2) To complete KEMET part number (T242), insert failure rate code from Ordering Information table.
(3) To complete KEMET T140 Part Number, insert Lead Material designator: S – Standard or T – 100% Matte Tin. Designates termination finish.

Table 1 – Ratings & Part Number Reference cont'd

Rated Voltage	Rated Cap	Case Size Code	KEMET Part Number	DC Leakage	DF % at 25°C	MIL-PRF-39003 (CSR23) Capacitors									
						Dash Number Reference								KEMET Equivalent Military	
						Failure Rate Level (%/1,000 Hours)									
						MIL-PRF-39003/3F				MIL-PRF-39003/3F					
						Exponential				Graded					
VDC	µF		(See below for part options)	µA at 25°C Max/5 Minutes	120 Hz Maximum	M (1.0)	P (0.1)	R (0.01)	S (0.001)	G (1)	B (0.1)	C (0.01)	D (0.001)	Part Number	
50	22.0	C	T140C226K050A(3)	7.0	6	0182	0282	0382	0482	5082	2082	3082	4082	T242C226K050(2)S	
50	22.0	C	T140C226M050A(3)	7.0	6	0183	0283	0383	0483	5083	2083	3083	4083	T242C226M050(2)S	
50	27.0	C	T140C276K050A(3)	8.0	6	0184	0284	0384	0484	5084	2084	3084	4084	T242C276K050(2)S	
50	27.0	C	T140C276M050A(3)	8.0	6										
50	33.0	D	T140D336K050A(3)	10.0	6	0185	0285	0385	0485	5085	2085	*	*	T242D336K050(2)S	
50	33.0	D	T140D336M050A(3)	10.0	6	0186	0286	0386	0486	5086	2086	*	*	T242D336M050(2)S	
50	39.0	D	T140D396K050A(3)	10.0	6	0187	0287	0387	0487	5087	2087	*	*	T242D396K050(2)S	
50	39.0	D	T140D396M050A(3)	10.0	6										
50	47.0	D	T140D476M050A(3)	10.0	6										
60	0.82	A	T140A824(1)060A(3)	0.5	4										
60	1.0	A	T140A105(1)060A(3)	0.5	4										
60	4.7	B	T140B475(1)060A(3)	3.0	4										
60	5.6	B	T140B565(1)060A(3)	3.0	4										
60	15.0	C	T140C156(1)060A(3)	5.0	6										
60	18.0	C	T140C186(1)060A(3)	6.0	6										
60	22.0	C	T140C226(1)060A(3)	7.0	6										
60	27.0	D	T140D276(1)060A(3)	10.0	6										
60	33.0	D	T140D336(1)060A(3)	10.0	6										
VDC	µF	Case Size Code	(See below for part options)	µA at 25°C Max/5 Minutes	120 Hz Maximum	M (1.0)	P (0.1)	R (0.01)	S (0.001)	G (1)	B (0.1)	C (0.01)	D (0.001)	Part Number	
Rated Voltage	Rated Cap	Case Size Code	KEMET Part Number	DC Leakage	DF % at 25°C	MIL-PRF-39003 (CSR23) Capacitors									

- (1) To complete KEMET part number, insert M for ±20% or K for ± 10%. Designates capacitance tolerance.
- (2) To complete KEMET part number (T242), insert failure rate code from Ordering Information table.
- (3) To complete KEMET T140 Part Number, insert Lead Material designator: S – Standard or T – 100% Matte Tin. Designates termination finish.

Ripple Current/Ripple Voltage

Permissible AC ripple voltage is related to the ESR of the capacitor and the power dissipation capabilities of a particular case size. Thermal capacities for the various case sizes have been determined empirically and are listed below.

Temperature Compensation Multipliers for Maximum Power Dissipation		
T ≤ 25°C	T ≤ 85°C	T ≤ 125°C
1.00	0.90	0.40

T = Environmental Temperature

Case Size	Maximum Power Dissipation (P max)	T2XX
A	0.09	0.070
B	0.100	0.090
C	0.125	–
D	0.180	–

Permissible AC ripple current can be determined by the following:

$$I(max) = Z \sqrt{P_{max}/R}$$

P max = maximum watts

R = ESR at specified frequency (ohms)

I = rms ripple current (amperes)

Z = capacitor impedance in ohms at the specified frequency

Maximum Power Dissipation: 25°C Ambient

Optimum Solder Wave Profile

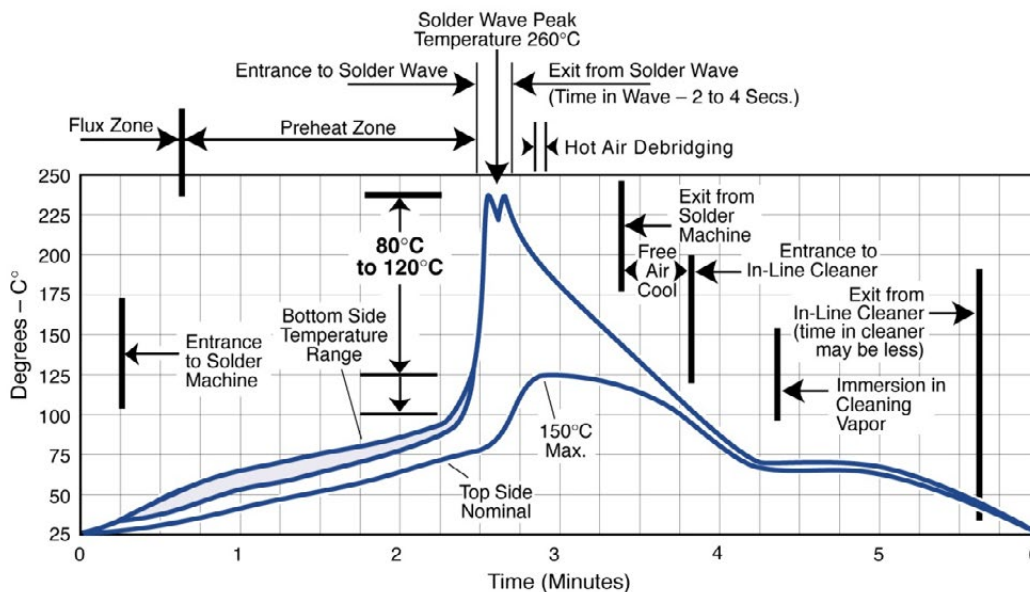

Reverse Voltage

Although these are polar capacitors, some degree of transient voltage reversal is permissible, as seen below. The capacitors should not be operated continuously in reverse mode, even within these limits.

Temperature	Percentage of Rated Voltage
+25°C	15
+85°C	5
+125°C	1

Mounting

All enclosed capacitors will pass the Resistance to Soldering Heat Test of MIL-STD-202, Method 210, Condition C. This test simulates wave solder of topside board mount product. This demonstration of resistance to solder heat is in accordance with what is believed to be the industry standard. More severe treatment must be considered reflective of an improper soldering process. The above figure is a recommended solder wave profile for both axial and radial leaded solid tantalum capacitors. Construction

Construction

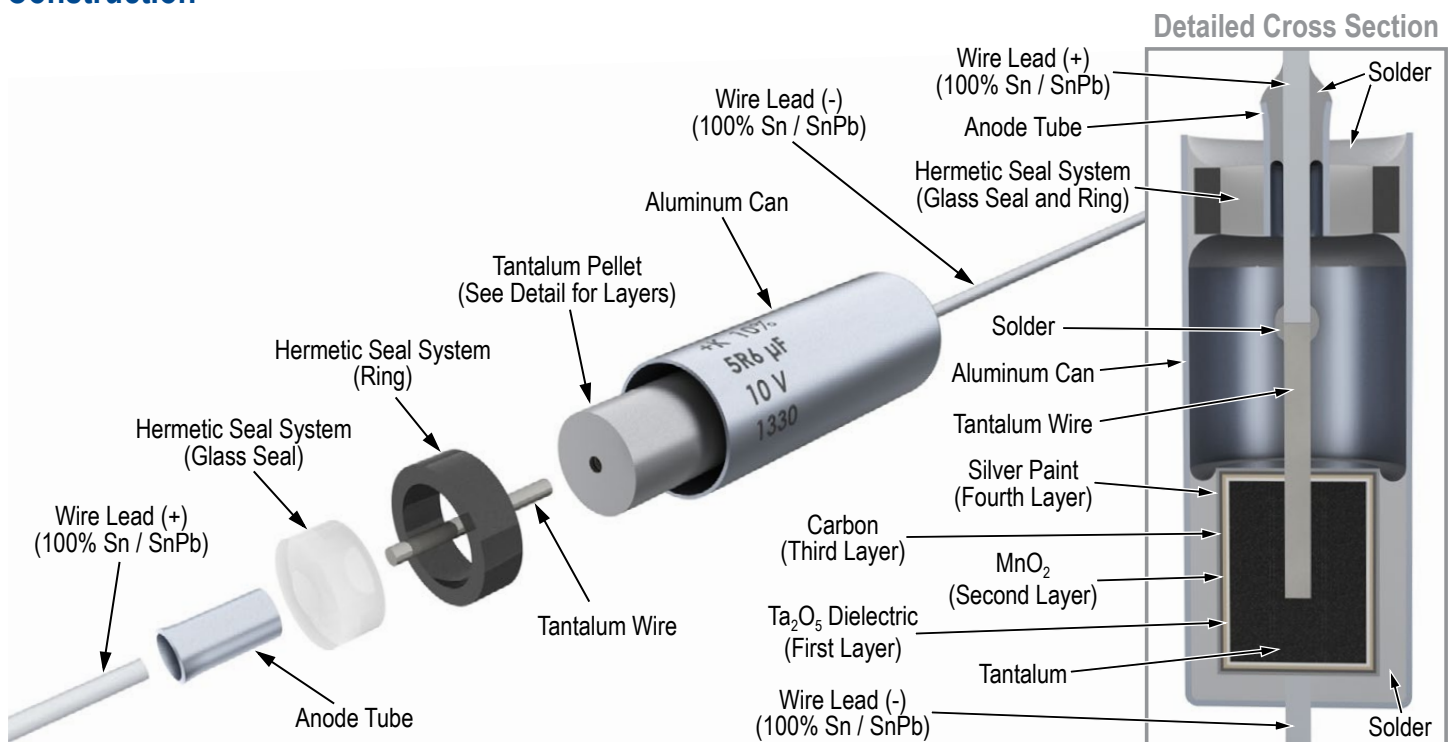

Capacitor Marking

T140

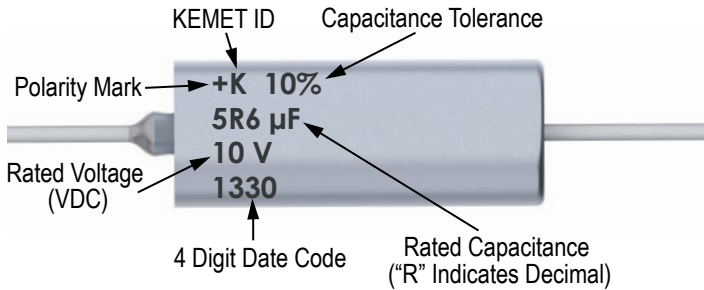

Date Code	3 Digit	4 Digit
Year	5 = 2015	15 = 2015
	6 = 2016	16 = 2016
	7 = 2017	17 = 2017
	8 = 2018	18 = 2018
	9 = 2019	19 = 2019
Week	01 = 1 st week of the year to 52 = 52 nd week of the year	

T242 – A Case

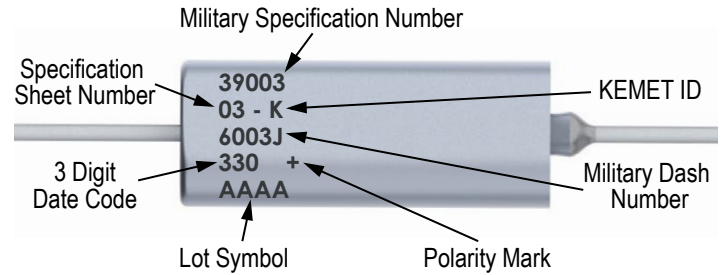

T242 – B Case

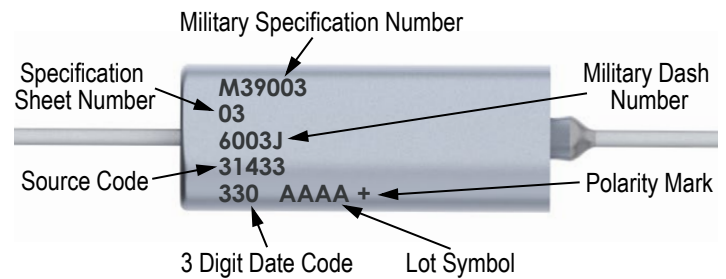

T242 – C & D Case

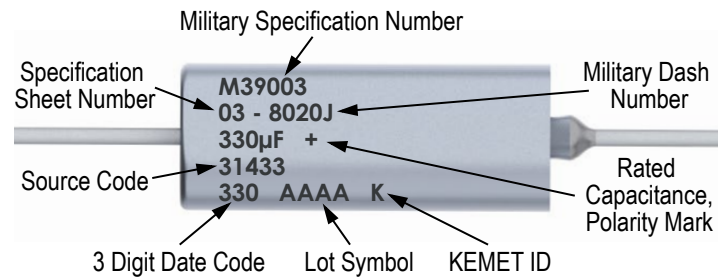

Storage

Tantalum hermetically sealed capacitors should be stored in normal working environments. While the capacitors themselves are quite robust in other environments, solderability will be degraded by exposure to high temperatures, high humidity, corrosive atmospheres, and long term storage. In addition, packaging materials will be degraded by high temperature– reels may soften or warp and tape peel force may increase. KEMET recommends that maximum storage temperature not exceed 40°C and maximum storage humidity not exceed 60% relative humidity. Temperature fluctuations should be minimized to avoid condensation on the parts and atmospheres should be free of chlorine and sulphur bearing compounds. For optimized solderability capacitors stock should be used promptly, preferably within three years of receipt.

Tape & Reel Packaging Information

KEMET offers standard reeling of Solid Tantalum Capacitors for automatic insertion or lead forming machines per EIA Specification RS-296E.

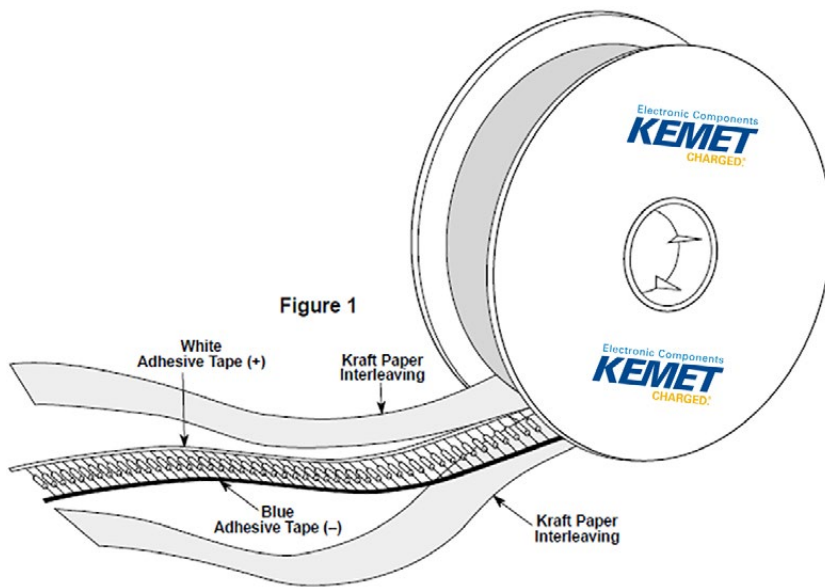

Table 2 – Packaging Quantity

Case Size	Standard Bulk Quantity	Standard Reel Quantity	Reel C-Spec	Ammo Pack Quantity	Ammo Pack C-Spec
A	150/Box	3,500	C-7200	1,500	C-7293
B	75/Box	2,500	C-7200	1,000	Class I
C	20/Tray	500	C-7200	250	C-7442
D	20/Tray	400	C-7200	250	Class II C-7443 Class III

Figure 2

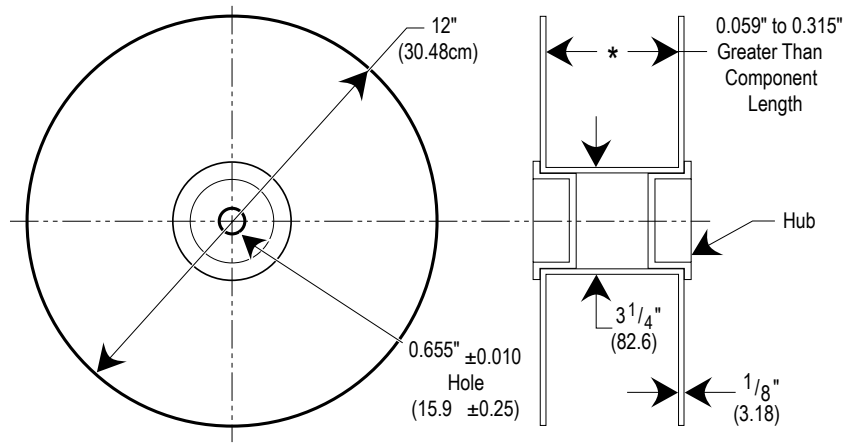

Figure 3

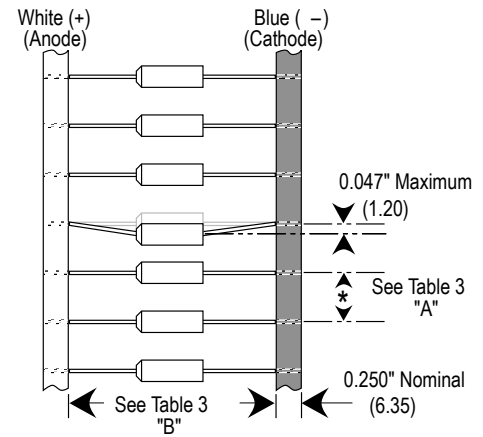

Table 3 – Tape Dimensions

Component Body Diameter	Component Pitch "A"	Inside Tape Spacing "B" ±1.5 mm (0.059")		
		I	II	III
0" (0 mm) to 0.197" (5 mm)	0.020" or (±0.5 mm)	2.062"	2.500"	2.874"
0.197" (5.01 mm) to 0.394" (10 mm)	0.400 or (10 mm)	(52.4 mm)	(63.5 mm)	(73 mm)

Capacitors are reeled so that positive leads are oriented as shown in Figure 3. Kraft paper (50lb. test minimum) is inserted between the layers of capacitors wound on reels for component pitch ≤ 0.200 " sizes and corrugated paper (70 lb. test minimum), single faced is inserted for component pitch ≥ 0.400 " sizes. Capacitor lead length may extend only a maximum of .031" (0.8 mm) beyond the tape's edges. Capacitors are centered in a row between the two tapes and will deviate only ± 0.031 " (0.79 mm) from the row center. Figures 1 and 2 show the KEMET standard chipboard tape reel. A minimum of 36" (91.5 cm) leader tape is provided at each end of the reeled capacitors. Universal splicing clips are used to connect the tape.

KEMET Corporation World Headquarters

2835 KEMET Way
Simpsonville, SC 29681

Mailing Address:
P.O. Box 5928
Greenville, SC 29606

www.kemet.com
Tel: 864-963-6300
Fax: 864-963-6521

Corporate Offices
Fort Lauderdale, FL
Tel: 954-766-2800

North America

Northeast

Wilmington, MA
Tel: 978-658-1663

Southeast

Lake Mary, FL
Tel: 407-855-8886

Central

Novi, MI
Tel: 248-994-1030

Irving, TX
Tel: 972-915-6041

West

Milpitas, CA
Tel: 408-433-9950

Mexico

Guadalajara, Jalisco
Tel: 52-33-3123-2141

Europe

Southern Europe

Sasso Marconi, Italy
Tel: 39-051-939111

Skopje, Macedonia
Tel: 389-2-55-14-623

Central Europe

Landsberg, Germany
Tel: 49-8191-3350800

Kamen, Germany
Tel: 49-2307-438110

Northern Europe

Wyboston, United Kingdom
Tel: 44-1480-273082

Espoo, Finland
Tel: 358-9-5406-5000

Asia

Northeast Asia

Hong Kong
Tel: 852-2305-1168

Shenzhen, China
Tel: 86-755-2518-1306

Beijing, China
Tel: 86-10-5877-1075

Shanghai, China
Tel: 86-21-6447-0707

Seoul, South Korea
Tel: 82-2-6294-0550

Taipei, Taiwan
Tel: 886-2-27528585

Southeast Asia

Singapore
Tel: 65-6701-8033

Penang, Malaysia
Tel: 60-4-6430200

Bangalore, India
Tel: 91-806-53-76817

Note: KEMET reserves the right to modify minor details of internal and external construction at any time in the interest of product improvement. KEMET does not assume any responsibility for infringement that might result from the use of KEMET Capacitors in potential circuit designs. KEMET is a registered trademark of KEMET Electronics Corporation.

Disclaimer

All product specifications, statements, information and data (collectively, the "Information") in this datasheet are subject to change. The customer is responsible for checking and verifying the extent to which the Information contained in this publication is applicable to an order at the time the order is placed.

All Information given herein is believed to be accurate and reliable, but it is presented without guarantee, warranty, or responsibility of any kind, expressed or implied.

Statements of suitability for certain applications are based on KEMET Electronics Corporation's ("KEMET") knowledge of typical operating conditions for such applications, but are not intended to constitute – and KEMET specifically disclaims – any warranty concerning suitability for a specific customer application or use. The Information is intended for use only by customers who have the requisite experience and capability to determine the correct products for their application. Any technical advice inferred from this Information or otherwise provided by KEMET with reference to the use of KEMET's products is given gratis, and KEMET assumes no obligation or liability for the advice given or results obtained.

Although KEMET designs and manufactures its products to the most stringent quality and safety standards, given the current state of the art, isolated component failures may still occur. Accordingly, customer applications which require a high degree of reliability or safety should employ suitable designs or other safeguards (such as installation of protective circuitry or redundancies) in order to ensure that the failure of an electrical component does not result in a risk of personal injury or property damage.

Although all product-related warnings, cautions and notes must be observed, the customer should not assume that all safety measures are indicated or that other measures may not be required.

X-ON Electronics

Largest Supplier of Electrical and Electronic Components

Click to view similar products for [kemet manufacturer](#):

Other Similar products are found below :

[C0603C151K5GAC7867](#) [49AN3470ZB01M](#) [CWR11KH106KCT250](#) [T543D477K006ATE015](#) [C1206N102K1GSLT500](#)
[C0805N330K1GSLT500](#) [CDR34BX154AKUS71897505](#) [C1206N393K5XSLT500](#) [C0805N100K1GSLT500](#) [C322C104M1U5TATR](#)
[C1206C223J1RAC7800](#) [C0603C120C5GAC7867](#) [C0402C222J4GACAUTO7411](#) [M39003/01-5168](#) [M39003/09-3052](#) [M39014/02-1238](#)
[ESK477M025AH1EA](#) [F161WP225K050V](#) [MMK10104K100A01L16.5TR18](#) [MMK10473K250A01L4BULK](#) [PEG130HJ4480QL1](#)
[PEH200YK4100MU2](#) [PHE426HD7220JR06L2](#) [ACA16B331JGS](#) [R46KR34704001K](#) [R474N32200001K](#) [R71PI36804030M](#)
[R75PR41504030J](#) [ALC10A181DC550](#) [ALC40A471DH450](#) [ALS30A332LF400](#) [EDK227M010A9HAA](#) [EFF\(03\)-240X240](#) [EFR\(03\)-240X240](#)
[EFX\(02\)-240X240T0800](#) [EFX\(05\)-240X240](#) [C0402C153K5RACTU](#) [C0402C182J3GACTU](#) [C0402C220J5GACAUTO](#)
[C0402C273K3RACTU](#) [C0402C331K5RACTU](#) [C0603C102J5GACAUTO](#) [C0603C102K3RACAUTO](#) [C0603C109B5GACTU](#)
[C0603C109C1GACTU](#) [C0603X152K5RAC7867](#) [C0805C101K2GACAUTO](#) [C0805C105K4RAC7800](#) [C0805C221J1GACAUTO](#)
[C0805C221J5GACTU](#)