

Tri-Start™ TV-CTV

MIL-DTL-38999 III subminiature cylindrical connectors



GENERAL CHARACTERISTICS

Main features

- **Shell material**
 - Composite
 - Aluminium
 - Marine bronze
 - Stainless steel
- **Finish**
 - Olive drab cadmium plating
 - Nickel plating
 - Passivation (for steel versions)
- 9 shell sizes from 09 to 25
- **Contacts**
 - More than 60 arrangements of contacts, including high density versions
 - Size 8, 10, 12, 16, 20, 22 D contacts
 - Signal, power, twinax, coaxial contacts, MOV, optical termini
- **Contact protection**
 - 100% scoop-proof shell
 - Interfacial seal ensures sealing around each contact and prevents electrolytic erosion
- **EMI/RFI protection**
 - Shell to shell bottoming
 - Grounding fingers on the plug shell
- **Quick coupling**
 - completely mates and self locks in a 360° turn of the coupling nut
- Performs sine and random vibration tests by an anti-decoupling device
- Receptacles are intermountable with MIL-DTL-38999 series I standard (same panel drilling)



Additional information

Amphenol Socapex offers a global solution: besides the TV-CTV wide range of connectors, the following products are available (please consult data sheets):

- Contacts (please refer to data sheet E114)
- Tooling (please refer to data sheet E119)
- Rear accessories (please refer to data sheet E121)
- FTV filtered connectors (French version only)



DESCRIPTION

The TV-CTV connectors are in accordance with MIL-DTL-38999 series III standard. These connectors offer the highest performance capabilities for both general duty and severe environment applications. Besides the most commonly used aluminium shell, different shell materials are available:

- The **composite** connector is a lightweight (17 to 70 % weight savings), corrosion resistant (withstanding 2000 hours of salt spray exposure) connector
 - The **nickel aluminium bronze** connector offers a high corrosion resistance and robustness for marine applications
 - The **stainless steel** connector provides a firewall capability
- The Amphenol TV connectors range also offers the following specific versions:
- **Ground Plane version** with a conductive insert for specific use with coaxial or triaxial contacts
 - **Receptacles** with reinforced sealing
 - **Hermetic version** in Y and N classes
 - **Filtered versions** using tubular or planar technology (please consult us)

High performance threaded cylindrical connectors

TV-CTV

APPLICATIONS

- **Military and aeronautic applications:** battlefields, ground vehicles, aircrafts
- **Advanced industrial applications:** high vibration requirements, high density



Amphenol

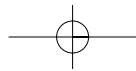
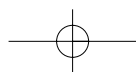
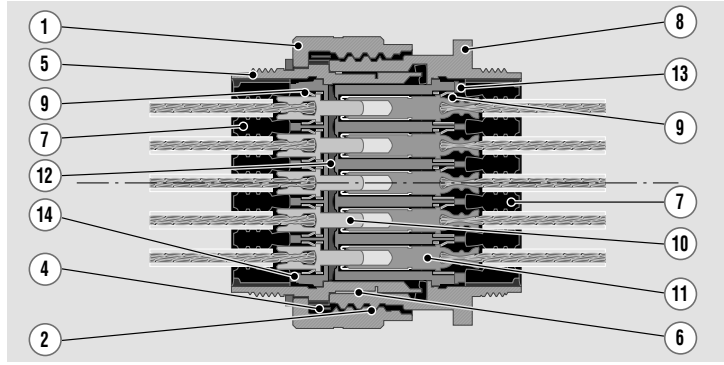
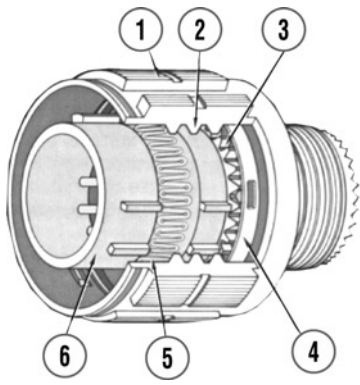

TABLE OF CONTENTS

GENERAL CHARACTERISTICS	1
TECHNICAL CHARACTERISTICS	
• Mechanical characteristics	3
• Environmental characteristics	4
• Electrical characteristics	5
• Insert arrangements	6
• Coding – Polarization	10
CTV COMPOSITE SHELLS	
• Presentation	11
• Overall dimensions	
Square flange receptacle	11
Jam nut receptacle	12
Straight plug	12
TV METALLIC SHELLS	
• Aluminium shells presentation	13
• Bronze shells presentation	13
• Stainless steel shells presentation	13
• Overall dimensions	
Square flange receptacle	14
Jam nut receptacle	14
Straight plug	15
PANEL DRILLING FOR COMPOSITE AND METALLIC RECEPTACLES	15
PRINTED CIRCUIT BOARD DRILLING	16
DATA BUS “GROUND PLANE” RECEPTACLES	19
TVS-Y/TVS-YN HERMETIC RECEPTACLES	
• Presentation	20
• Overall dimensions	
Square flange receptacle	20
Jam nut receptacle	21
Solder mounting receptacle	21
LANYARD RELEASE PLUGS	
• Presentation	22
• Overall dimensions	
Lanyard release plug – MIL-STD-1760	22
Lanyard release plug	23
ACCESSORIES	
• Protection caps	24
• Plastic dust caps	25
• Standard contacts	25
• Sealing plugs	25
• Holding support with dummy receptacles	25
• Torque value for rear accessories	25
TOOLING	
• Crimping tools	26
• Insertion and removal tools	26
CONNECTORS ORDERING INFORMATION	
• Composite and metallic versions . . . Amphenol designation (TV/CTV)	27
Military designation (JD38999)	28
• Data bus “ground plane” receptacles	28
• Hermetic versions	
Amphenol designation (TV)	29
Military designation (JD38999)	29
• MIL-STD-1760 Lanyard release plugs	30
• Lanyard release plugs	31
• Cross references (Amphenol and military designations)	32





- | | |
|--------------------------|----------------------------|
| 1 Locking ring | 8 Receptacle shell |
| 2 Quick coupling thread | 9 Contact retention clips |
| 3 Ratchet | 10 Crimping pin contact |
| 4 Anti decoupling device | 11 Crimping socket contact |
| 5 Plug shell | 12 Interfacial seal |
| 6 Spring fingers (EMI) | 13 Socket insert |
| 7 Grommet | 14 Pin insert |

Mechanical characteristics

- Thermoplastic insert
- Silicone rubber back insert and interfacial seal
- Durability: - 500 cycles
- 1500 cycles with composite connector " CTV " fitted with " H " and " J " contact types
- Shocks: half sine wave of 300 G magnitude during 3ms per MIL - STD - 0901
- Sine vibrations: - 60 g from - 55°C to + 175°C (olive drab cadmium finish)
- 60 g from - 55°C to 200°C (nickel finish and firewall version)
- Random vibrations: - 1 G² / Hz at 175°C olive drab cadmium finish
- 1 G² / Hz at 200°C nickel finish and firewall version
- 5G² / Hz at ambient
- Bending moment

Shell size	Bending moment	
	Series III MIL-DTL-38999	Amphenol
A	09	11.3
B	11	33.9
C	13	45.2
D	15	56.5
E	17	67.8
F	19	79.1
G	21	90.4
H	23	101.7
J	25	113.0

- Contact retention force

Contact size	22D	20	16	12	10	8
Maximum load (N)	45	67	110	110	150	150

TECHNICAL CHARACTERISTICS

TV-CTV



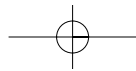

Environmental characteristics

- Salt spray exposure and working temperature:

- Waterproof shells

Shell material	Shell finish	Salt spray exposure per MIL. STD 1344/1009	Class norm	Amphenol	Working temperature	
					mini	maxi
Composite	Electroless Nickel O.D cadmium	2000 H	M	CTV-RF	-65°C	+200°C
		2000 H	J	CTV-RW	-65°C	+175°C
Aluminium	Electroless Nickel O.D cadmium	48 H	F	TVS-RF	-65°C	+200°C
		500 H	W	TV-RW	-65°C	+175°C
Stainless steel	Nickel —	48 H	S	TVS-RS	-65°C	+200°C
		500 H	K	TVS-RK	-65°C	+200°C
Bronze	—	1000 H		TVS-RB	-65°C	+200°C

- Hermetic shells

Shell material	Shell finish	Salt spray exposure per MIL. STD 1344/1009	Class norm	Amphenol	Working temperature	
					mini	maxi
Stainless steel	Nickel —	48 H	N	TVS-YN	-65°C	+200°C
		500 H	Y	TVS-Y	-65°C	+200°C

- **Humidity:** per MIL-DTL-38999: § 3.29
- **Altitude immersion:** according to MIL-DTL-38999 III standard (except hermetics)
- **Air leakage** $< 1.10^{-7}$ cm³/s under 1 bar of pressure differential (hermetics only)
- **Fluid resistance (per MIL-DTL-38999), § 3.33:**
 - MIL-L-7808 (lubricating oil)
 - MIL-L-23699 (lubricating oil)
 - MIL-H-5606 (hydraulic fluid)
 - Hydraulic fluid (Chevron M2V)
 - MIL-A-8243 (defrosting fluid)
 - MIL-C-87936 type I
 - MIL-T-5624 (JP5)
 - MIL-C-47220 or Coolanol 25 or equivalent
 - MIL-G-3056 type I (gasoline)
 - Isopropyl alcohol per TT-I-735 grade A or B mixed with mineral spirit TT-T-291 type I or P-D-680 type I

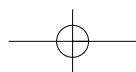

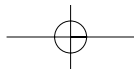

Electrical characteristics

- **Contact rating:** nominal current per contact

Contact size	22D	20	16	12	10	8
Crimp (A)	5	7.5	13	23	33	60
Hermetic (A)	3	5	10	17	—	—

- **Contact resistance**

Contact size	22D	20	16	12	10	8
Contact resistance (mΩ)	8	4.7	2	1.1	0.6	0.6

- **Insulation resistance**

Insulation resistance (500 V)	Crimp	Hermetic
Ambient temperature	≥ 10 ⁵ MΩ	≥ 5 x 10 ³ MΩ
Maximum temperature	≥ 10 ³ MΩ	≥ 5 x 10 ² MΩ

- **Service rating**

Service	Dielectric withstanding voltage (Vrms)								Working voltage	
	At sea level		15000 meters		21000 meters		34000 meters		Vrms	Vdc
	mated	unmated	mated	unmated	mated	unmated	mated	unmated		
M	1300	1300	800	550	800	350	800	200	400	550
N	1000	1000		400		260		200	300	450
I	1800	1800	1000	600	1000	400	1000	200	600	850
II	2300	2300	1000	800	1000	500	1000	200	900	1250

- **Dimensions of acceptable contacts and cables**

Contact Size	Contact Diameter mm	Crimp barrel Diameter mm	Crimp barrel Depth mm	Acceptable cables						
				Gauge AWG				Outside diameter (mm)		
				Section mm ²				Min	Average	Max
22D	0.76	0.88+/-0.03	3.58	22	24	26	28	0.76	1.20	1.37
				0.38	0.22	0.15	0.095			
20	1	1.19+/-0.03	5.30	20	22	24		1.02	1.83	2.11
				0.60	0.38	0.22				
16	1.57	1.70+/-0.03	5.30	16	18	20		1.68	2.41	2.77
				1.34	0.93	0.60				
12	2.36	2.54+/-0.06	5.30	12	14			2.46	3.20	3.61
				3.30	1.94					
10	3.17	3.48+/-0.06	9	10	12			2.97		3.88
				5	3					
8 Power	3.60	4.6+0.05/-0	10	8				4.5		5.8
				8.98 Max acceptable: 10mm ²						

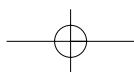

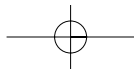

Insert arrangements

Front face view of male insert

The major keyway is shown in the «normal» position

Contact size	22D	20	16	12	10	8
Caption						

- ① MIL insert arrangement reference
- ② TV-CTV insert arrangement reference
- ③ Service class
- ④ Number of contacts
- ⑤ Contact sizes

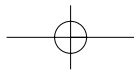
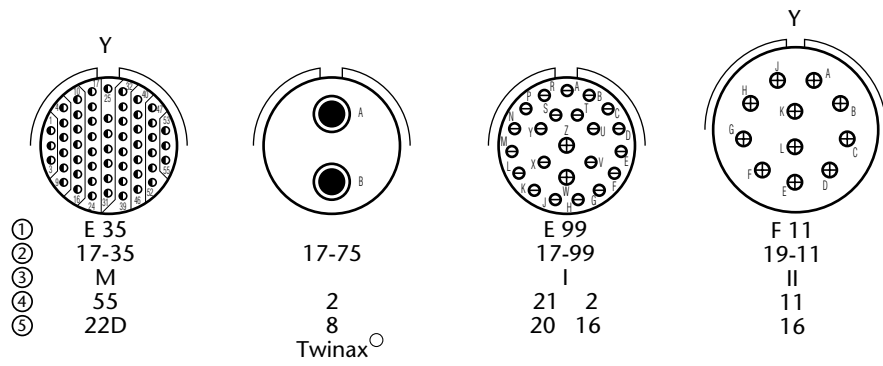
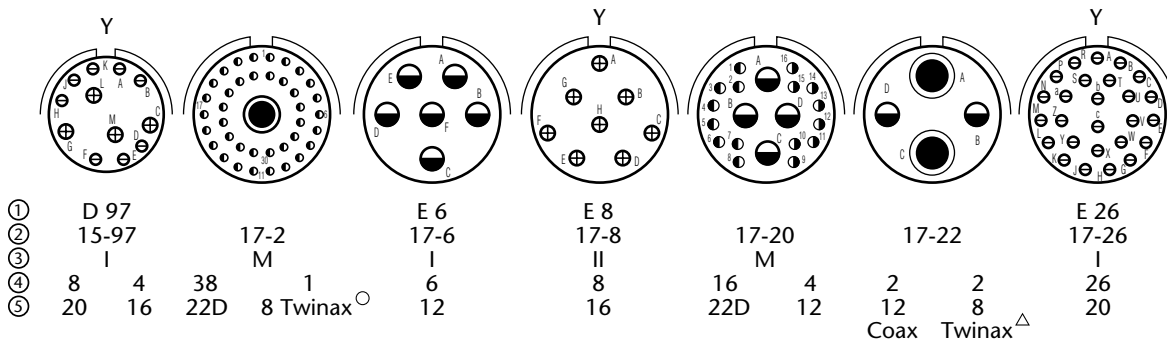
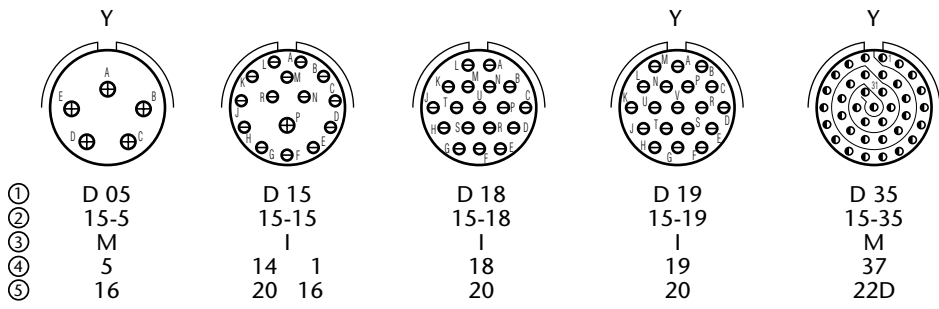
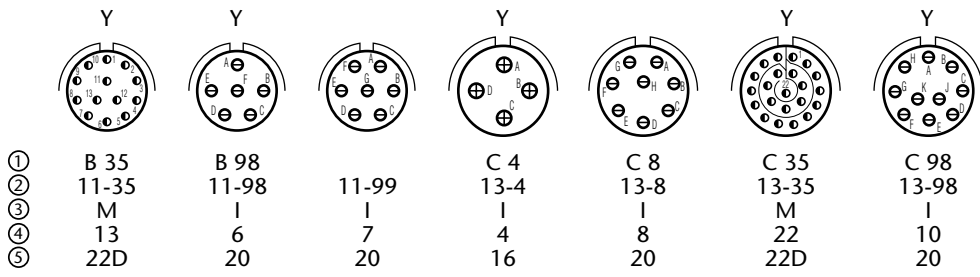
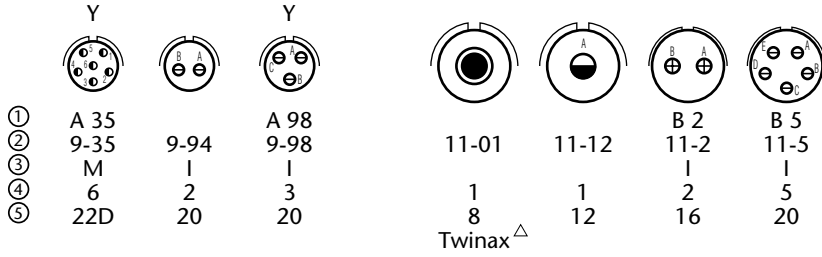

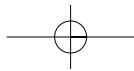

Insert arrangements

Front face view of male insert

The major keyway is shown in the «normal» position

Contact size	22D	20	16	12	10	8
Caption						

- ① MIL insert arrangement reference
- ② TV-CTV insert arrangement reference
- ③ Service class
- ④ Number of contacts
- ⑤ Contact sizes

①	19-17	19-28	19-30	19-31	F 32	F 35
②	M	I	I	M	19-32	19-35
③	10	26	29	2	I	M
④	1	2	1	12	32	66
⑤	22D	20	16	8 Coax 12 22D	20	22D
①	G 11	G 16	G 35	G 39		
②	21-11	21-16	21-35	21-39		
③	I	II	M	I		
④	11	16	79	37		
⑤	12	16	22D	20		
①	G 41	21-48	G 75	23-6		
②	21-41	M	21-75	M		
③	I	4	M	4		
④	41	8 Power	8 Coax or 8 Twinax*	8 Twinax [○]		
⑤	20					
①	H 21	23-32	H 35	H 53	23-54	H 55
②	23-21	I	23-35	23-53	M	23-55
③	II	32	M	I	40	I
④	21	20	100	53	9	55
⑤	16		22D	20	22D	20
①	J 4	25-7	25-8	J 11		
②	25-4	M		25-11***		
③	I			N		
④	48	97	8	2		
⑤	8	22D	8 Twinax [○]	20		
	20			10 Power		
	16					

INSERT ARRANGEMENTS

TV-CTV



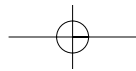

Insert arrangements

Front face view of male insert

The major keyway is shown in the «normal» position

Contact size	22D	20	16	12	10	8
Caption	●	⊖	⊕	◐	◎	⦿

- ① MIL insert arrangement reference
- ② TV-CTV insert arrangement reference
- ③ Service class
- ④ Number of contacts
- ⑤ Contact sizes

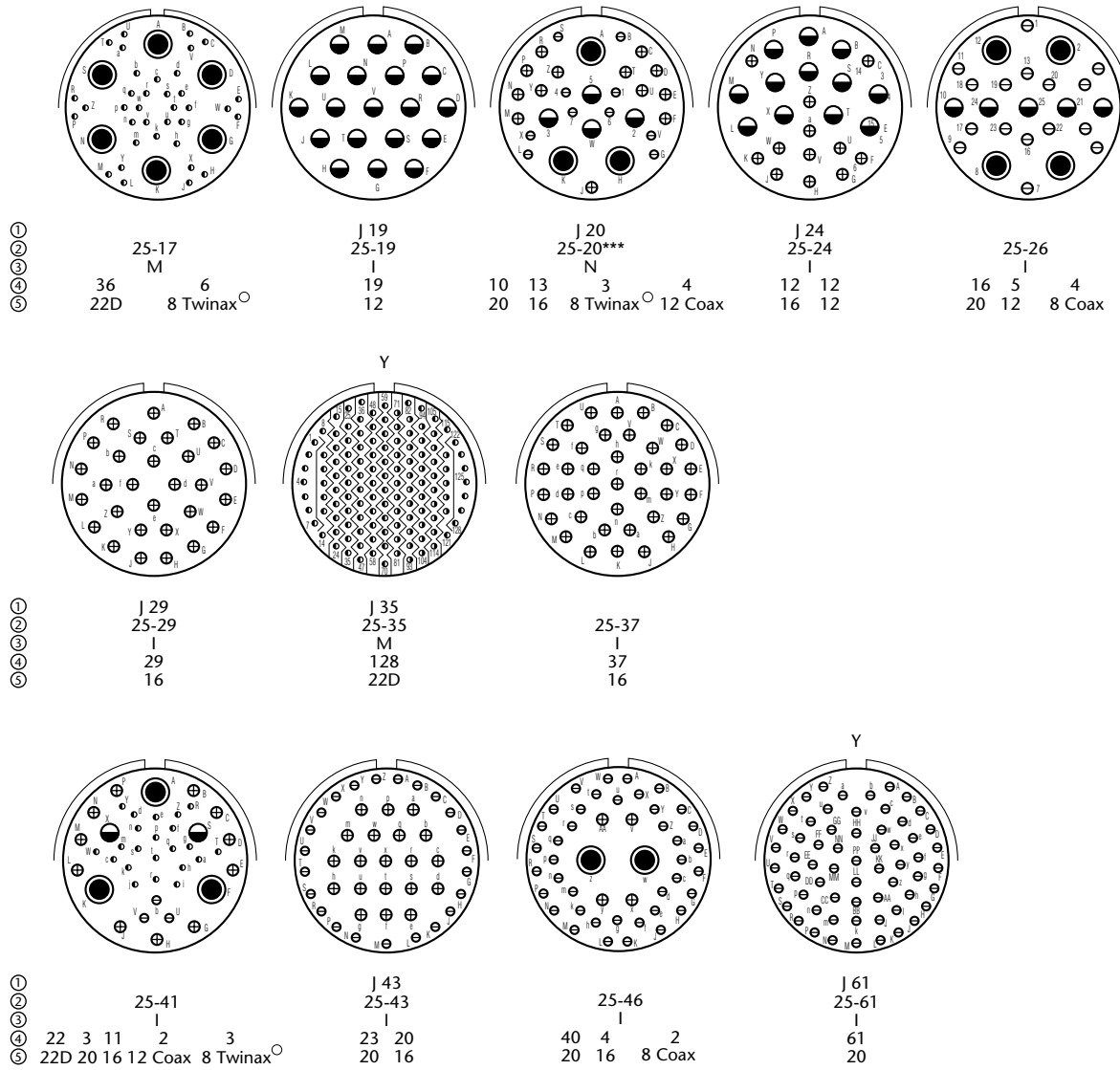

* Military P/N delivered with 8 twinax and proprietary P/N delivered with size 8 coaxial contacts for RG 180 and RG 195 wire

*** For MIL STD 1760 application

Y Available in hermetic version

△ Delivered with twinax contacts for double braid cable (PAN 6421, AECMA Pr EN 3375 - 004, Raychem 10613, EPD44692, EPD44693).

○ Delivered with twinax contacts for simple braid cable (M17/1760002, AECMA Pr EN 3375 - 003, Raychem 10612, EPD44690, EPD44691).

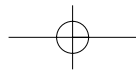



Arrangements CTV	TV	Service Class	Total number of contacts	Number and size of contacts											Grounded insert availability**				
				22D	20	16	16G**	12	12 coax	12G**	10 power	8 power	8 coax	8 triax of twinax	8G**	P	S		
9-5**	9-5**		1														1	X	X
9-35	9-35	M	6	6															
9-94	9-94	M	2		2														
9-98	9-98	I	3		3														
11-1	11-1		1												1				
11-2**	11-2**		2				2											X	
11-2	11-2	I	2			2													
11-5	11-5	I	5		5														
11-12	11-12	II	1					1											
11-35	11-35	M	13	13															
11-98	11-98	I	6		6														
11-99	11-99	I	7		7														
13-4**	13-4**		4				4											X	
13-4	13-4	I	4			4													
13-8	13-8	I	8		8														
13-35	13-35	M	22	22															
13-98	13-98	I	10		10														
15-5**	15-5**		5				5											X	
15-5	15-5	II	5			5													
15-15	15-15	I	15		14	1													
15-18	15-18	I	18		18														
15-19	15-19	I	19		19														
15-35	15-35	M	37	37															
15-97	15-97	I	12		8	4													
17-2	17-2	M	39	38										1					
17-6**	17-6**		6						6									X	
17-6	17-6	I	6					6											
17-8**	17-8**		8				8											X	X
17-8	17-8	II	8			8													
17-20	17-20	M	20	16				4											
17-22**	17-22**		4						2						2		X		
17-22	17-22		4						2					2					
17-26	17-26	I	26		26														
17-35	17-35	M	55	55															
17-75	17-75	I	2										2						
17-99	17-99	I	23		21	2													
19-11	19-11	II	11			11													
19-17	19-17	M	17	10	1	4								2					
19-28	19-28	I	28		26	2													
19-30	19-30	I	30		29	1													
19-31	19-31	M	15	12				1					2						
19-32	19-32	I	32		32														
19-35	19-35	M	66	66															
21-11	21-11	I	11					11											
21-16**	21-16**		16				16											X	
21-16	21-16	II	16			16													
21-35	21-35	M	79	79															
21-39	21-39	I	39		37	2													
21-41	21-41	I	41		41														
21-48	21-48		4									4							
21-75	21-75	M	4										4						
21-75**	21-75**		4											4		X			

Legend: ** Grounded version (metallic insert for use with coaxial or twinax contacts, for receptacle only). For details, please refer to page 19
 *** 25-11 and 25-20 arrangements used for interconnection per MIL-STD-1760

INSERT ARRANGEMENTS

TV-CTV

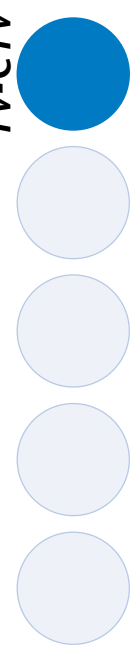

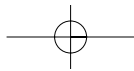

Arrangements CTV	TV	Service Class	Total number of contacts	Number and size of contacts											Grounded insert availability		
				22D	20	16	16G**	12	12 coax	12G**	10 power	8	8 coax	8 triax of twinax	8G**	P	S
23-6	23-6	M	6												6		
23-6**	23-6**	M	6												6		X
23-21	23-21	II	21			21											
23-21**	23-21	II	21				21										X
23-32	23-32	I	32		32												
23-35	23-35	M	100	100													
23-53	23-53	I	53		53												
23-54	23-54	M	53	40		9		4									
23-55	23-55	I	55		55												
25-4	25-4	I	56		48	8											
25-7	25-7	M	99	97										2			
25-8	25-8	M	8											8			
25-8**	25-8**	M	8											8			X
25-11***	25-11***	N	11		2					9							
25-17	25-17	M	42	36										6			
25-19	25-19	I	19					19									
25-19**	25-19**	I	19						19								X
25-20***	25-20***	N	30		10	13			4*					3			
25-24	25-24	I	24			12		12									
25-26	25-26	I	25		16			5					4				
25-29**	25-29**	I	29				29										X
25-29	25-29	I	29			29											
25-35	25-35	M	128	128													
25-37	25-37	I	37			37											
25-41	25-41	I	41	22	3	11			2*					3			
25-43	25-43	I	43		23	20											
25-46	25-46	I	46		40	4							2				
25-61	25-61	I	61		61												

Legend: ** Grounded version (metallic insert for use with coaxial or twinax contacts, for receptacle only). For details, please refer to page 19
 *** 25-11 and 25-20 arrangements used for interconnection per MIL-STD-1760

Coding - polarization

To avoid cross-plugging problems in applications requiring the use of more than one MIL-DTL-38999 III connector of the same size, alternate key-rotations are available as indicated in the accompanying chart. As shown in the diagram below, the secondary keys rotate clockwise from the major one.

In the reference system, the polarization is shown by the letters N, A, B, C, D or E.

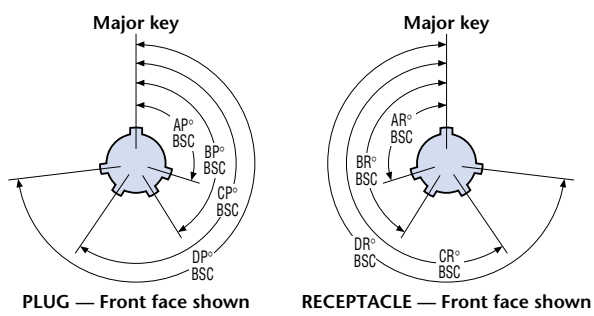

Shell size	Coding identification letter	AR° or AP° BSC	BR° or BP° BSC	CR° or CP° BSC	DR° or DP° BSC
9	N	105	140	215	265
	A	102	132	248	320
	B	80	118	230	312
	C	35	140	205	275
	D	64	155	234	304
	E	91	131	197	240
11 13 and 15	N	95	141	208	236
	A	113	156	182	292
	B	90	145	195	252
	C	53	156	220	255
	D	119	146	176	298
17 and 19	E	51	141	184	242
	N	80	142	196	293
	A	135	170	200	310
	B	49	169	200	244
	C	66	140	200	257
	D	62	145	180	280
21 23 and 25	E	79	153	197	272
	N	80	142	196	293
	A	135	170	200	310
	B	49	169	200	244
	C	66	140	200	257
D	62	145	180	280	
	E	79	153	197	272

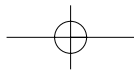

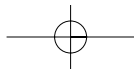

CTV composite shells

Presentation

Tri-Start CTV series are in accordance with MIL-DTL-38999-III.

The composite used for this series was developed to meet aeronautic market requirements:

- Mass saving (20-40% compared to Aluminium versions / 60-70% compared to stainless steel versions)
- Great corrosion resistance
- Useful life extension
- Great EMI-RFI shielding

CTV Connectors are intermatable and intermountable with TV metallic versions.

Note: Locking rings and hexagonal nuts are delivered without plating (black)

Main characteristics

- Shell to shell conductivity: - Individual value: 3 millivolts
- Value after test: 6 millivolts
- Durability: - 500 cycles with standards contacts
- 1500 cycles with "H" type (M 39029) pin contacts and "J" type (M 39029) socket contacts
- Hydrostatic stability: NASA OUTGASSING SP-R 0022 , § 40
- Ozone exposure: § 3.32 MIL-DTL-38999
- Moisture exposure: MIL-STD-810C, method 508-2
- Standard MIL wiring tools

Overall dimensions - Composite versions

CTVP00RW JD38999/20J
CTVPS00RF JD38999/20M
Square flange receptacle

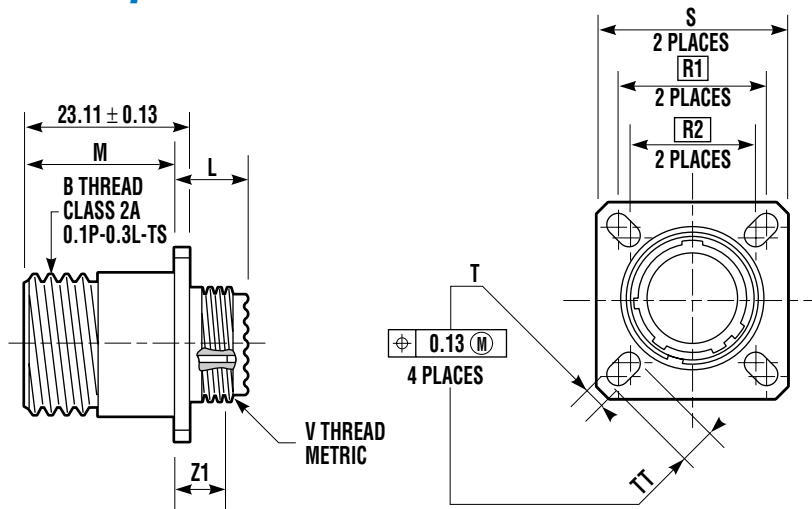

Shell size		B Thread (inches)	L Max (mm)	M +0.00 -0.13 (mm)	R ¹ (mm)	R ² (mm)	S ±0.25 (mm)	T +0.20 -0.13 (mm)	Z1 Max (mm)	TT +0.20 -0.13 (mm)	V thread metric
MIL-DTL-38999 Series III	Amphenol Socapex										
A	9	.6250	13.055	19.685	18.26	15.09	23.83	3.25	5.03	5.49	M12x1-6g
B	11	.7500	13.055	19.685	20.62	18.26	26.19	3.25	5.03	4.93	M15x1-6g
C	13	.8750	13.055	19.685	23.01	20.62	28.58	3.25	5.03	4.93	M18x1-6g
D	15	1.0000	13.055	19.685	24.61	23.01	30.96	3.25	5.03	4.39	M22x1-6g
E	17	1.1875	13.055	19.685	26.97	24.61	33.32	3.25	5.03	4.93	M25x1-6g
F	19	1.2500	13.055	19.685	29.36	26.97	36.53	3.25	5.03	4.93	M28x1-6g
G	21	1.3750	13.843	18.923	31.75	29.36	39.67	3.25	5.79	4.93	M31x1-6g
H	23	1.5000	13.843	18.923	34.93	31.75	42.88	3.91	5.79	6.15	M34x1-6g
J	25	1.6250	13.843	18.923	38.10	34.93	46.02	3.91	5.79	6.15	M37x1-6g

For panel drilling, please refer to page 15
For PCB contacts stickout, please refer to page 16

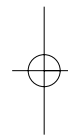
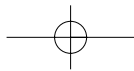

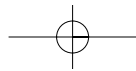

CTV07 RW JD38999/24J
 CTVS07 RF JD38999/24M
 Jam nut receptacle

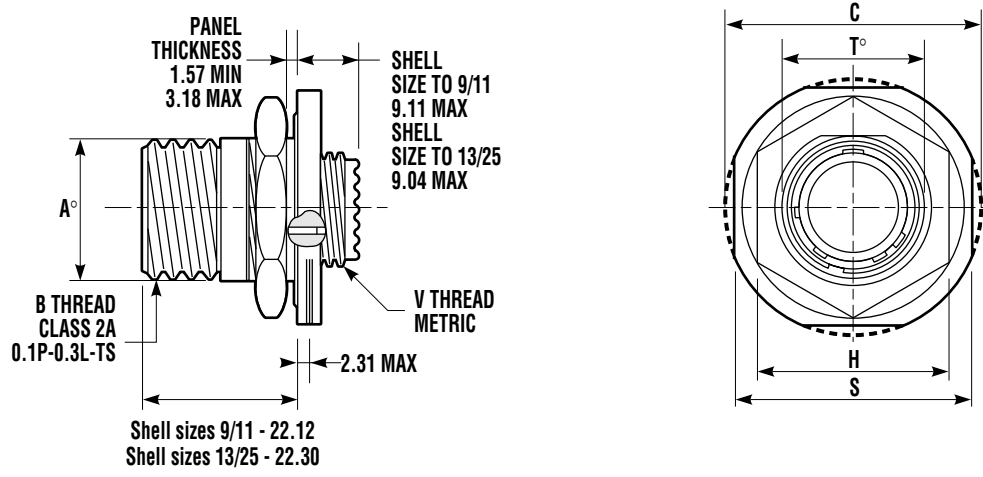

Shell size		A	B	C	H Hex	S	T	V thread	Hex nut
MIL-DTL-38999 Series III	Amphenol Socapex	+0.00 -0.025 (mm)	Thread (inches)	Max (mm)	+0.043 -0.041 (mm)	+0.028 -0.025 (mm)	±0.025 -0.000 (mm)	metric	max torque N.m
A	9	16.99	.6250	30.45	22.23	26.97	17.70	M12x1-6g	4.1
B	11	19.53	.7500	35.20	25.40	31.75	20.88	M15x1-6g	5.3
C	13	24.26	.8750	38.38	30.17	34.92	25.58	M18x1-6g	6.9
D	15	27.53	1.0000	41.55	33.32	38.10	28.80	M22x1-6g	8.6
E	17	30.68	1.1875	44.73	36.52	41.28	31.98	M25x1-6g	9.8
F	19	33.86	1.2500	49.50	39.67	46.02	35.15	M28x1-6g	10.9
G	21	37.06	1.3750	52.65	42.87	49.22	38.28	M31x1-6g	12.7
H	23	40.00	1.5000	55.85	46.02	52.37	41.50	M34x1-6g	13.8
J	25	43.41	1.6250	59.00	50.80	55.57	44.68	M37x1-6g	15

For panel drilling, please refer to page 15
 For PCB contacts stickout, please refer to page 16

CTV06 RW JD38999/26J
 CTVS06 RF JD38999/26M
 Straight plug

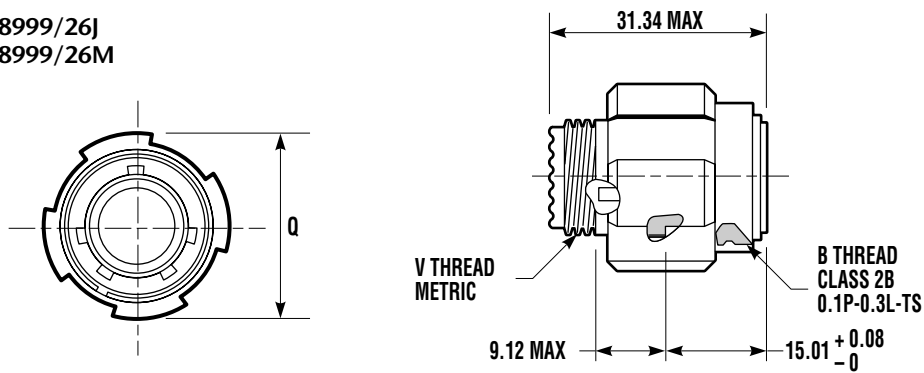

Shell size		B	Q	V thread
MIL-DTL-38999 Series III	Amphenol Socapex	Thread (inches)	Max (mm)	metric (mm)
A	9	.6250	21.82	M12x1-6g
B	11	.7500	24.99	M15x1-6g
C	13	.8750	29.39	M18x1-6g
D	15	1.0000	32.49	M22x1-6g
E	17	1.1875	35.69	M25x1-6g
F	19	1.2500	38.48	M28x1-6g
G	21	1.3750	41.68	M31x1-6g
H	23	1.5000	44.88	M34x1-6g
J	25	1.6250	47.98	M37x1-6g

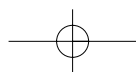

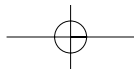

TV metallic shells

TVS-F / TV-W Aluminium shells

Presentation

Aluminium TV shell connectors are used in professional and international electronic defense programs in standard environmental conditions.

Main characteristics

- Material shell: Aluminium alloy.
- Shell to shell conductivity:
 - 1 mΩ for F class
 - 2.5 mΩ for W class
- EMI-RFI shielding:
 - 65 db to 10 Ghz, F class
 - 50 db to 10 Ghz, W class
 - 85 db to 1 Ghz, F and W class
- Standard MIL wiring tools

TVS-B Marine bronze shells

Presentation

TVS-B bronze shell connectors are not defined in MIL-DTL-38999-III-J standard but they are based on its requirements.

TVS-B connectors conform to the European standard CECC 75.201.002.

This series was initially selected by the British Navy for a new generation of ships. By extension a lot of the NATO Navy choose this series as a standard of interconnection.

TVS-B connector is now the most popular circular connector to be used in marine application.

Main characteristics

- Material shell: Nickel aluminium bronze DGS 1043.
- EMI-RFI shielding: > 65 dB at 100 Mhz to 10 Ghz.
- Standard MIL wiring tools

TVS-K / TVS-S Stainless steel shells

Presentation

Stainless steel shell connectors are used in high temperature environments and in harsh vibration conditions. They provide FIREWALL capabilities.

Main characteristics

- Thermosetting insert
- Working temperature:
 - 65°C, + 200°C
 - 1093°C during 20 minutes
- Shell to shell conductivity:
 - 10 millivolts for K class
 - 1 millivolts for S class
- EMI-RFI shielding:
 - 45 dB mini at 10 Ghz for K class
 - 65 dB mini at 10 Ghz for S class



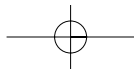

Overall dimensions / Metallic versions

TVP00RW JD38999/20W
 TVPS00RF JD38999/20F
 TVPS00RB
 TVPS00RK JD38999/20K
 TVPS00RS JD38999/20S
 Square flange receptacle

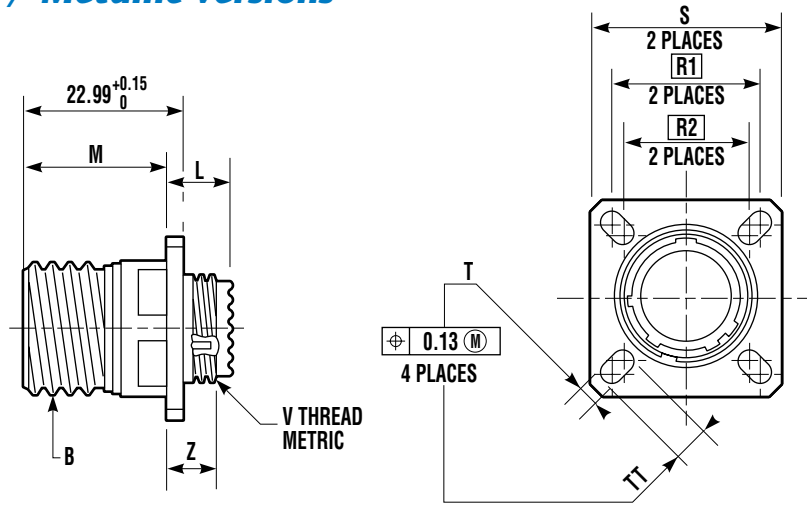

Shell size		B Thread Class 2A 0.1P-0.3L-TS (inches)	L Max (mm)	M +0.00 -0.13 (mm)	R' (mm)	R'' (mm)	S ±0.25 (mm)	T +0.20 -0.13 (mm)	Z Max (mm)	TT +0.20 -0.13 (mm)	V thread metric
MIL-DTL-38999 Series III	Amphenol Socapex										
A	9	.6250	11.91	20.83	18.26	15.09	23.83	3.25	3.89	5.49	M12x1-6g
B	11	.7500	11.91	20.83	20.62	18.26	26.19	3.25	3.89	4.93	M15x1-6g
C	13	.8750	11.91	20.83	23.01	20.62	28.58	3.25	3.89	4.93	M18x1-6g
D	15	1.0000	11.91	20.83	24.61	23.01	30.96	3.25	3.89	4.39	M22x1-6g
E	17	1.1875	11.91	20.83	26.97	24.61	33.32	3.25	3.89	4.93	M25x1-6g
F	19	1.2500	11.91	20.83	29.36	26.97	36.53	3.25	3.89	4.93	M28x1-6g
G	21	1.3750	12.70	20.07	31.75	29.36	39.67	3.25	4.65	4.93	M31x1-6g
H	23	1.5000	12.70	20.07	34.93	31.75	42.88	3.91	4.65	6.15	M34x1-6g
J	25	1.6250	12.70	20.07	38.10	34.93	46.02	3.91	4.65	6.15	M37x1-6g

For panel drilling, please refer to page 15
 For PCB contacts stickout, please refer to page 16

TV07RW JD38999/24W
 TVS07RF JD38999/24F
 TVS07RB
 TVS07RK JD38999/24K
 TVS07RS JD38999/24S
 Jam nut receptacle

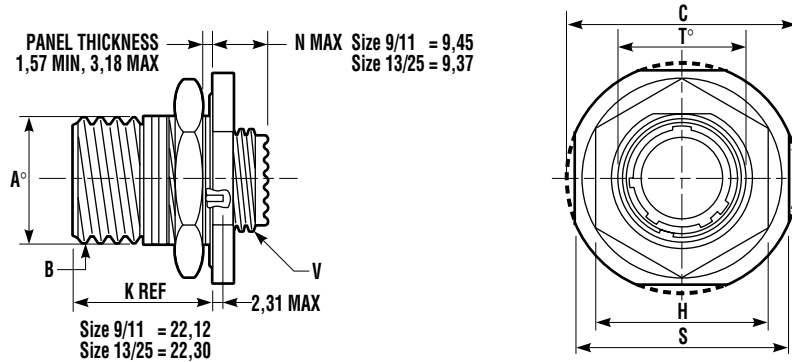

Shell size		B Thread Class 2A 0.1P-0.3L-TS (inches)	A +0.00 -0.025 (mm)	C Max (mm)	H Hex +0.043 -0.041 (mm)	S ±0.25 (mm)	T ±0.025 -0.000 (mm)	V thread metric	Hex nut max torque value N.m
MIL-DTL-38999 Series III	Amphenol Socapex								
A	9	.6250	16.99	30.45	22.23	26.97	17.70	M12x1-6g	4.1
B	11	.7500	19.53	35.20	25.40	31.75	20.88	M15x1-6g	5.3
C	13	.8750	24.26	38.38	30.17	34.93	25.58	M18x1-6g	6.9
D	15	1.0000	27.53	41.55	33.32	38.10	28.80	M22x1-6g	8.6
E	17	1.1875	30.68	44.73	36.52	41.28	31.98	M25x1-6g	9.8
F	19	1.2500	33.86	49.50	39.67	46.02	35.15	M28x1-6g	10.9
G	21	1.3750	37.06	52.65	42.87	49.23	38.28	M31x1-6g	12.7
H	23	1.5000	40.00	55.85	46.02	52.37	41.50	M34x1-6g	13.8
J	25	1.6250	43.41	59.00	50.80	55.58	44.68	M37x1-6g	15

For panel drilling, please refer to page 15
 For PCB contacts stickout, please refer to page 16

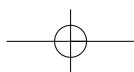

TV06RW JD38999/26W
 TVS06RF JD38999/26F
 TVS06RB
 TVS06RK JD38999/26K
 TVS06RS JD38999/26S
 Straight plug

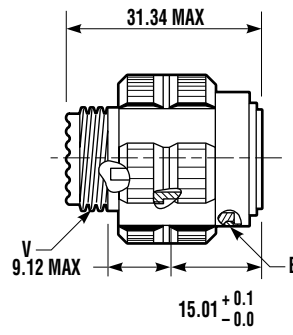
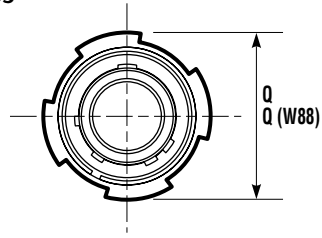

Shell size		B Thread Class 2A 0.1P-0.3L-TS (mm)	Q Max (mm)	V thread metric	Q (W88)* (mm)
MIL-DTL-38999 Series III	Amphenol Socapex				
A	9	.6250	21.82	M12x1-6g	21.1
B	11	.7500	24.62	M15x1-6g	23.8
C	13	.8750	28.98	M18x1-6g	28.2
D	15	1.0000	32.16	M22x1-6g	31.4
E	17	1.1875	35.33	M25x1-6g	36.5
F	19	1.2500	38.10	M28x1-6g	39.3
G	21	1.3750	41.28	M31x1-6g	42.5
H	23	1.5000	44.45	M34x1-6g	45.3
J	25	1.6250	47.63	M37x1-6g	48.4

* Conforms to CECC 75.201.002

Panel drilling for composite and metallic receptacles

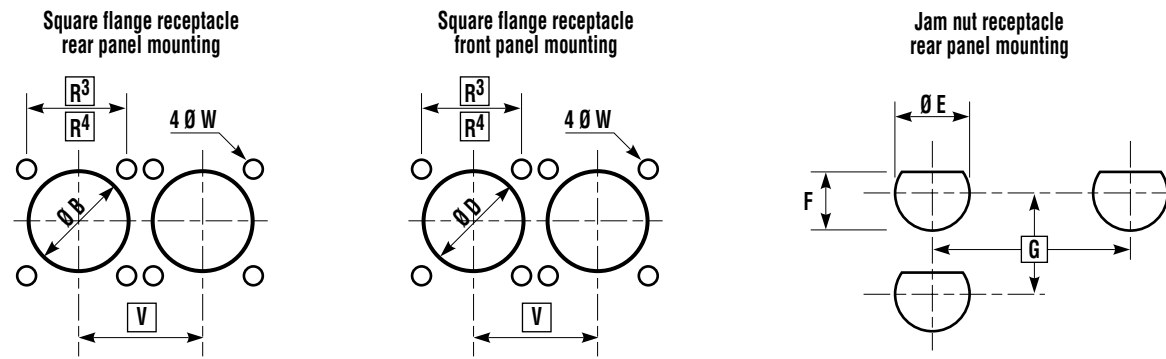

Shell size		R ³	R ⁴	V	Ø W	G	Ø E	F	Ø B	Ø D
MIL-DTL-38999 Series III	Amphenol Socapex	(mm)	(mm)	Mini (mm)	+0 -0.25 (mm)	Mini (mm)	Mini (mm)	+0 -0.25 (mm)	Mini (mm)	Mini (mm)
A	9	18.26	15.09	24.60	3.25	27.80	17.70	16.99	16.66	13.11
B	11	20.62	18.26	27.00	3.25	32.60	20.88	19.53	20.22	15.88
C	13	23.01	20.62	31.50	3.25	36.00	25.58	24.26	23.42	19.05
D	15	24.61	23.01	34.50	3.25	39.60	28.80	27.53	26.59	23.01
E	17	26.97	24.61	28.00	3.25	43.30	31.98	30.68	30.96	25.81
F	19	29.36	26.97	40.50	3.25	47.00	35.16	33.86	32.94	28.98
G	21	31.75	29.36	44.00	3.25	50.60	38.28	37.06	36.12	32.16
H	23	34.93	31.75	47.00	3.81	54.20	41.50	40.01	39.29	34.93
J	25	38.10	34.93	50.00	3.81	59.70	44.68	43.41	42.47	37.69

PANEL DRILLING FOR COMPOSITE AND METALLIC RECEPTACLES

TV-CTV



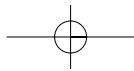

Printed circuit board drilling

Receptacles equipped with size 22D contacts

The marking of contact cavities is shown on the mating side view of the male receptacle. The marking on the female plug is symmetrical in relation to the +X/-Y axis.

Cavity marking	x (mm)	y (mm)
1	+1.14	+1.98
2	+1.98	-1.14
3	0	-2.29
4	-1.98	-1.14
5	-1.14	+1.98
6	0	0

9-35

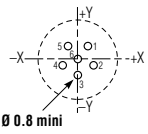

6 contacts size 22D

Cavity marking	x (mm)	y (mm)
1	0	+3.71
2	+2.16	+3.00
3	+3.51	+1.14
4	+3.51	-1.14
5	+2.16	-3.00
6	0	-3.71
7	-2.16	-3.00
8	-3.51	-1.14
9	-3.51	+1.14
10	-2.16	+3.00
11	0	+4.2
12	+1.24	-0.89
13	-1.24	-0.89

11-35

13 contacts size 22D

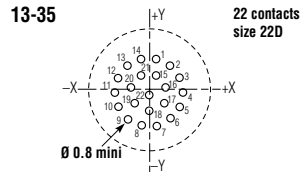
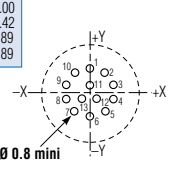

22 contacts size 22D

Cavity marking	x (mm)	y (mm)
1	+1.14	+5.00
2	+3.20	+4.01
3	+4.62	+2.24
4	+5.16	0

Cavity marking	x (mm)	y (mm)
5	+4.62	-2.24
6	+3.20	-4.01
7	+1.14	-5.00
8	-1.14	-5.00

Cavity marking	x (mm)	y (mm)
9	-3.20	-4.01
10	-4.62	-2.24
11	-5.16	0
12	-4.62	+2.24
13	-3.20	+4.01
14	-1.14	+5.00
15	+1.14	+2.72
16	+2.97	+0.66
17	+2.36	-1.91
18	0	-3.05
19	-2.36	-1.91
20	-2.97	+0.66
21	-1.14	+2.72
22	0	-0.76

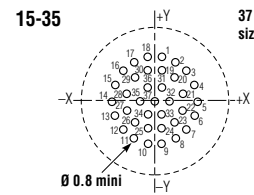

37 contacts size 22D

Cavity marking	x (mm)	y (mm)
17	-3.12	+5.51
18	-1.14	+6.65
19	+1.14	+4.35
20	+3.12	+3.02
21	+4.32	+1.02
22	+4.32	-1.27
23	+3.12	-3.23
24	+1.14	-4.37
25	-1.14	-4.37
26	-3.12	-3.23
27	-4.32	-1.27
28	-4.32	+1.02
29	-3.12	+3.02
30	-1.14	+4.37
31	+1.14	+1.88
32	+2.29	-0.10
33	+1.14	-2.08
34	-1.14	-2.08
35	-2.29	-0.10
36	-1.14	+1.88
37	0	-0.10

Cavity marking	x (mm)	y (mm)
1	+1.14	+6.65
2	+3.12	+5.51
3	+5.36	+4.06
4	+6.45	+2.03
5	+6.76	-0.25
6	+6.27	-2.49
7	+5.08	-4.45
8	+3.30	-5.89

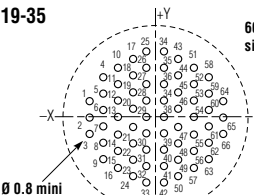

66 contacts size 22D

Cavity marking	x (mm)	y (mm)
35	+1.14	+6.86
36	+1.14	+4.57
37	+1.14	+2.29
38	+1.14	0
39	+1.14	-2.29
40	+1.14	-4.57
41	+1.14	-6.86
42	+1.14	-9.14
43	+3.12	+8.00
44	+3.12	+5.72
45	+3.12	+3.43
46	+3.12	+1.14
47	+3.12	-1.14
48	+3.12	-3.43
49	+3.12	-5.72
50	+3.12	-8.00
51	+5.11	-6.86
52	+5.11	+4.57
53	+5.11	+2.29
54	+5.11	0
55	+5.11	-2.29
56	+5.11	-4.57
57	+5.11	-6.86
58	+5.11	-9.14
59	+7.09	+3.43
60	+7.09	+1.14
61	+7.09	-1.14
62	+7.09	-3.43
63	+7.09	-5.72
64	+9.07	+2.29
65	+9.07	0
66	+9.07	-2.29

Cavity marking	x (mm)	y (mm)
1	-9.07	+2.29
2	-9.07	0
3	-9.07	-2.29
4	-7.09	+5.72
5	-7.09	+3.43
6	-7.09	+1.14
7	-7.09	-1.14
8	-7.09	-3.43
9	-7.09	-5.72
10	-5.11	+6.86
11	-5.11	+4.57
12	-5.11	+2.29
13	-5.11	0
14	-5.11	-2.29
15	-5.11	-4.57
16	-5.11	-6.86
17	-3.12	+8.00

Cavity marking	x (mm)	y (mm)
1	+1.35	+10.82
2	+3.71	+10.26
3	+5.89	+9.19
4	+7.77	+7.67
5	+9.27	+5.77
6	+10.31	+3.58
7	+10.85	+1.22
8	+10.85	-1.22
9	+10.31	-3.58
10	+9.27	-5.77
11	+7.77	-7.67
12	+5.89	-9.19
13	+3.71	-10.26
14	+1.35	-10.82
15	-1.35	-10.82
16	-3.71	-10.26
17	-5.89	-9.19
18	-7.77	-7.67
19	-9.27	-5.77
20	-10.31	-3.58
21	-10.85	-1.22
22	-10.85	+1.22
23	-10.31	+3.58
24	-9.27	+5.77
25	-7.77	+7.67
26	-5.89	+9.19
27	-3.71	+10.26

Cavity marking	x (mm)	y (mm)
28	-1.35	+10.82
29	0	+8.20
30	+2.49	+8.18
31	+4.67	+7.11
32	+6.55	+5.59
33	+7.90	+3.58
34	+8.43	+1.22
35	+8.43	-1.22
36	+7.90	-3.58
37	+6.55	-5.59
38	+4.67	-7.11
39	+2.49	-8.18
40	0	-8.84
41	-2.49	-8.18
42	-4.67	-7.11
43	-6.55	-5.59
44	-7.90	-3.58
45	-8.43	-1.22
46	-8.43	+1.22
47	-7.90	+3.58
48	-6.55	+5.59
49	-4.67	+7.11
50	-2.49	+8.18
51	-1.22	+6.12
52	+1.22	+6.12
53	+3.40	+5.05
54	+5.28	+3.53

21-35

79 contacts size 22D

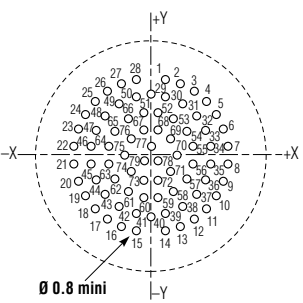

23-35

100 contacts size 22D

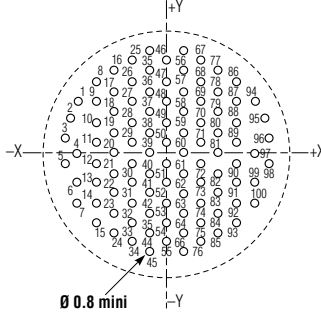

Cavity marking	x (mm)	y (mm)
55	+6.02	+1.22
56	+6.02	-1.22
57	+5.28	-3.53
58	+3.40	-5.05
59	+1.22	-6.12
60	-1.22	-6.12
61	-3.40	-5.05
62	-5.28	-3.53
63	-6.02	-1.22
64	-6.02	+1.22
65	-5.28	+3.53
66	-3.40	+5.05
67	-1.22	+6.12
68	-1.22	+3.71
69	+3.18	+2.29
70	+3.94	0
71	+3.18	-2.29
72	+1.22	-3.71
73	-1.22	-3.71
74	-3.18	-2.29
75	-3.94	0
76	-3.18	+2.29
77	0	+1.35
78	+1.22	-0.74
79	-1.22	-0.74

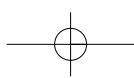

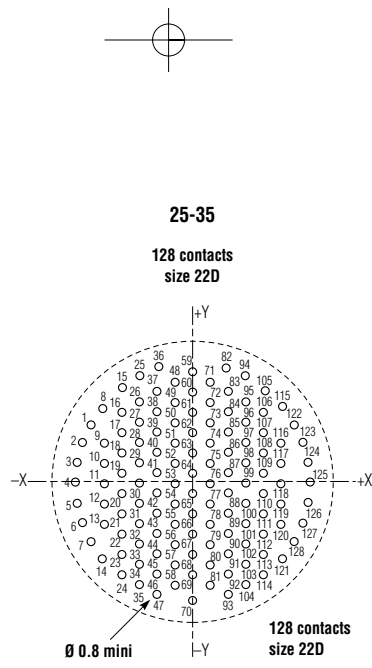

Cavity marking	x (mm)	y (mm)	Cavity marking	x (mm)	y (mm)	Cavity marking	x (mm)	y (mm)	Cavity marking	x (mm)	y (mm)	Cavity marking	x (mm)	y (mm)	Cavity marking	x (mm)	y (mm)
1	-2.17	+7.09	23	-8.43	-8.43	45	-4.22	-8.43	67	0	-6.02	89	+4.22	-3.61	111	+8.43	-3.61
2	-13.21	+4.83	24	-8.43	-10.85	46	-4.22	-10.85	68	0	-8.43	90	+4.22	-6.02	112	+8.43	-6.02
3	-13.87	+2.41	25	-6.32	+12.60	47	-4.22	-13.26	69	0	-0.85	91	+4.22	-8.43	113	+8.43	-8.43
4	-14.10	0	26	-6.32	+9.65	48	-2.11	+12.07	70	0	-14.10	92	+4.22	-10.85	114	+8.43	-10.85
5	-13.87	-2.41	27	-6.32	+7.24	49	-2.11	+9.65	71	+2.11	+12.70	93	+4.22	-13.26	115	+10.77	+9.07
6	-13.21	-4.83	28	-6.32	+4.83	50	-2.11	+7.24	72	+2.11	+9.65	94	+6.32	-12.60	116	+10.54	+4.83
7	-12.17	-7.09	29	-6.32	+2.41	51	-2.11	+4.83	73	+2.11	+7.24	95	+6.32	+9.65	117	+10.54	+2.41
8	-10.77	+9.07	30	-6.32	0	52	-2.11	+2.41	74	+2.11	+4.83	96	+6.32	+7.24	118	+10.54	0
9	-10.54	+4.83	31	-6.32	-2.41	53	-2.11	0	75	+2.11	+2.41	97	+6.32	+4.83	119	+10.54	-2.41
10	-10.54	+2.41	32	-6.32	-4.83	54	-2.11	-2.41	76	+2.11	0	98	+6.32	+2.41	120	+10.54	-4.83
11	-10.54	0	33	-6.32	-7.24	55	-2.11	-4.83	77	+2.11	-2.41	99	+6.32	0	121	+10.77	-9.07
12	-10.54	-2.41	34	-6.32	-9.65	56	-2.11	-7.24	78	+2.11	-4.83	100	+6.32	-2.41	122	+12.07	+7.09
13	-10.54	-4.83	35	-6.32	-12.07	57	-2.11	-9.65	79	+2.11	-7.24	101	+6.32	-4.83	123	+13.21	+4.83
14	-10.77	-9.07	36	-4.06	+13.49	58	-2.11	-12.07	80	+2.11	-9.65	102	+6.32	-7.24	124	+13.87	+2.41
15	-8.43	+11.28	37	-4.22	+10.85	59	0	+13.26	81	+2.11	-12.07	103	+6.32	-9.65	125	+14.10	0
16	-8.43	+8.43	38	-4.22	+8.43	60	0	+10.85	82	+4.06	+13.49	104	+6.32	-12.07	126	+13.87	-2.41
17	-8.43	+6.02	39	-4.22	+6.02	61	0	+8.43	83	+4.22	+10.85	105	+8.43	+11.28	127	+13.21	-4.83
18	-8.43	+3.61	40	-4.22	+3.61	62	0	+6.02	84	+4.22	+8.43	106	+8.43	+8.43	128	+12.17	-7.09
19	-8.43	+1.19	41	-4.22	+1.19	63	0	+3.61	85	+4.22	+6.02	107	+8.43	+6.02			
20	-8.43	-1.19	42	-4.22	-1.19	64	0	+1.19	86	+4.22	+3.61	108	+8.43	+3.61			
21	-8.43	-3.61	43	-4.22	-3.61	65	0	-1.19	87	+4.22	+1.19	109	+8.43	+1.19			
22	-8.43	-6.02	44	-4.22	-6.02	66	0	-3.61	88	+4.22	-1.19	110	+8.43	-1.19			

Receptacles equipped with size 20 contacts

The marking of contact cavities is shown on the mating side view of the male receptacle. The marking on the female plug is symmetrical in relation to the +X/-Y axis.

Cavity marking	x (mm)	y (mm)
A	+1.65	+0.97
B	0	-1.91
C	-1.65	+0.97

9-98

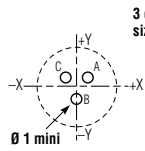

3 contacts size 20

Cavity marking	x (mm)	y (mm)
A	0	+3.30
B	+3.30	0
C	+1.65	-2.87
D	-1.65	-2.87
E	-3.30	0
F	0	0

11-98

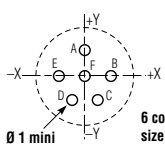

6 contacts size 20

10 contacts size 20

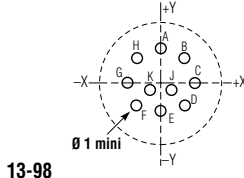

13-98

Cavity marking	x (mm)	y (mm)
A	0	+4.95
B	+3.18	+3.81
C	+4.90	+0.76
D	+4.17	-2.67
E	0	-3.43
F	-4.17	-2.67
G	-4.90	+0.76
H	-3.18	+3.81
J	+1.65	-0.38
K	-1.65	-0.38

15-19

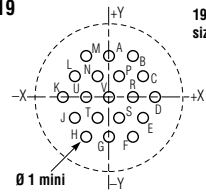

19 contacts size 20

Cavity marking	x (mm)	y (mm)	Cavity marking	x (mm)	y (mm)
A	0	+5.72	C	+4.95	+2.87
B	+3.30	+5.72	D	+6.60	0

Cavity marking	x (mm)	y (mm)
E	+4.95	-2.87
F	+3.30	-5.72
G	0	-5.72
H	-3.30	-5.72
J	-4.95	-2.87
K	-6.60	0
L	-4.95	+2.87
M	-3.30	+5.72
N	-1.65	+2.87
P	+1.65	+2.87
R	+3.30	0
S	+1.65	-2.87
T	-1.65	-2.87
U	-3.30	0
V	0	0

Cavity marking	x (mm)	y (mm)	Repère contact	x (mm)	y (mm)
A	0	+8.15	E	+8.10	-0.86
B	+3.33	+7.44	F	+7.06	-4.09
C	+6.07	+5.44	G	+4.80	-6.60
D	+7.75	+2.51	H	+1.70	-7.98

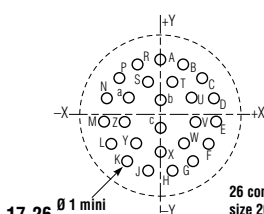

17-26 0.1 mini 26 contacts size 20

Cavity marking	x (mm)	y (mm)
J	-1.70	-7.98
K	-4.80	-6.60
L	-7.06	-4.09
M	-8.10	-0.86
N	-7.75	+2.51
P	-6.07	+5.44
R	-3.33	+7.44
S	-1.78	+4.50
T	+1.78	+4.50
U	+4.45	+2.39
V	+4.52	-0.91
X	0	+5.16
Y	-3.02	-3.84
Z	-4.52	-0.91
a	-4.45	+2.39
b	0	+1.65
c	0	-1.65

PRINTED CIRCUIT BOARD DRILLING

TV-CTV



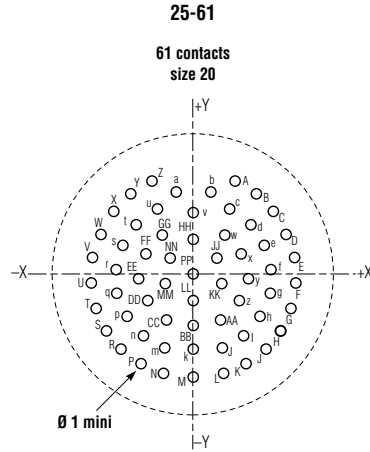
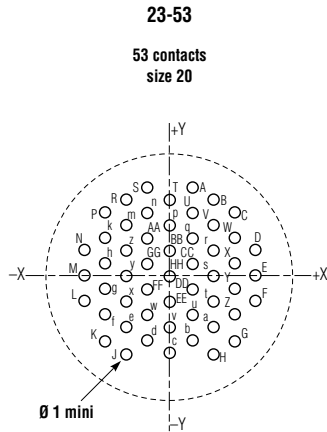
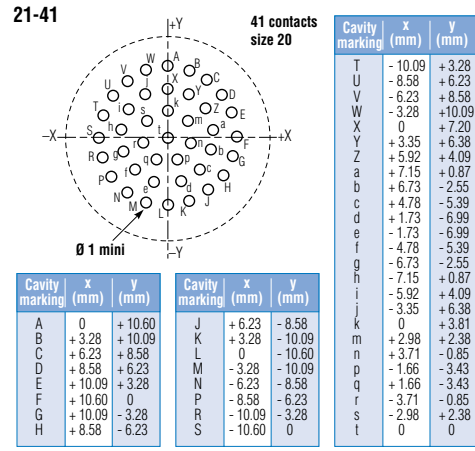
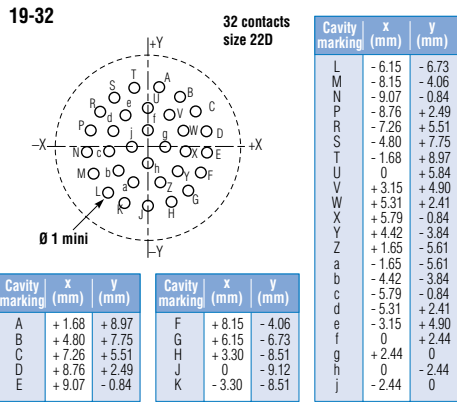
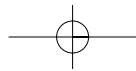

Please consult us for other insert arrangements.

Standard PCB - tail dimensions at the rear of receptacles (in mm)

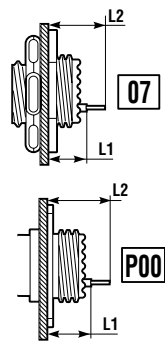

		TV 07 & CTV 07		TVP 00		CTVP 00		
		09 to 11	13 to 25	09 to 19	21 to 25	09 à 19	21 to 25	
		P	L1	min	10.13	9.95	11.55	12.31
max	11.07			10.89	12.39	13.15	13.52	14.28
L2	min		15.03	14.85	16.45	17.21	17.61	18.37
	max		16.17	15.99	17.49	18.25	18.62	19.38
S	L1	min	9.93	9.75	11.35	12.11	12.51	13.27
		max	10.87	10.69	12.19	12.95	13.32	14.08
	L2	min	14.83	14.65	16.25	17.01	17.41	18.17
		max	15.97	15.79	17.29	18.05	18.42	19.18

Please refer to data sheet E114 for other PCB-tail versions.

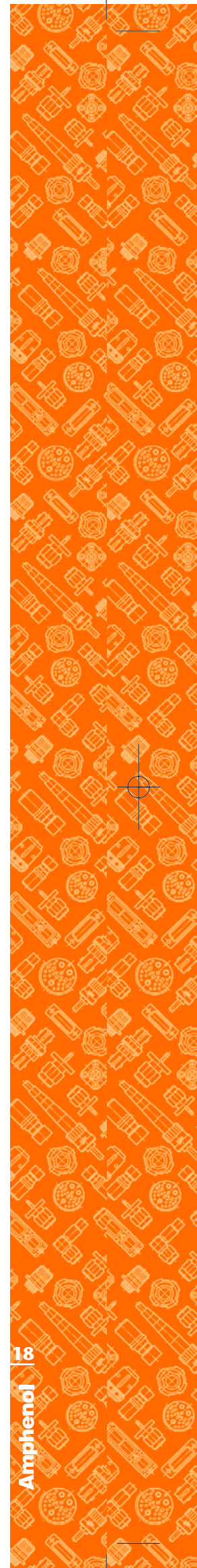
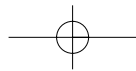

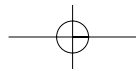

Data bus "ground plane" receptacle

Presentation

With Data Bus "Ground Plane" receptacles the electrical link between the outer shielding of coaxial or twinax contacts and the shell of the connector is realized, avoiding any cabling operation between the cable braid and the shell.

Main characteristics

- Composite shells (for TV metallic shells, please consult us)
- Olive drab cadmium or electroless nickel plating
- Mate with standard CTV (or TV) plugs
- Connect the BUS per STANAG 3910 20 Mbits and STANAG 3838 1 Mbits
- Contact resistance < 10 mΩ (Test report BCO 9-8523-1 available)

Insert arrangements

Front face view of male insert

The major keyway is shown in the «normal» position

Contact size	8 G Grounded	12 G Grounded	16 G Grounded
Caption			

- ① MIL insert arrangement reference
- ② TV-CTV insert arrangement reference
- ③ Service class
- ④ Number of contacts
- ⑤ Contact sizes

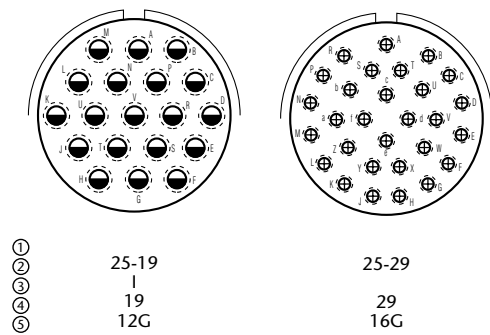
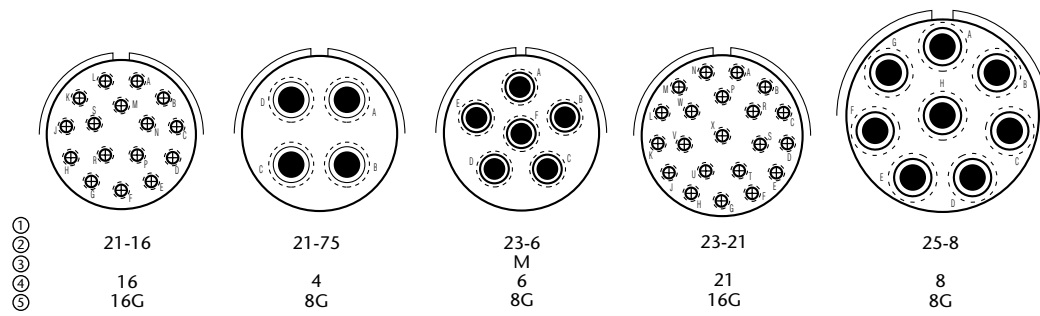
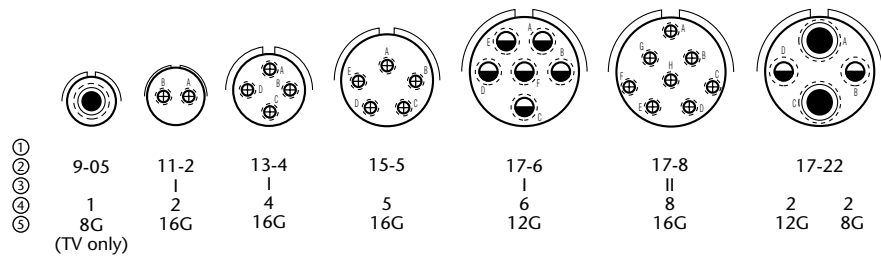

For insert availability, please refer to pages 9-10.
For panel drilling, please refer to page 15.

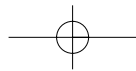

DATA BUS "GROUND PLANE" RECEPTACLES

TV-CTV

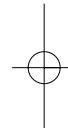
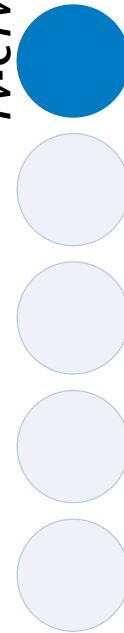

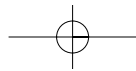

TVS-Y / TVS-YN hermetic receptacles

Presentation

Hermetic receptacles TVS-Y and TVS-YN are used in applications which require the maintenance of pressure in the shell or box and in equipments imposing reduce bulk at the rear of connectors.

Main characteristics

- 9 shell sizes (stainless steel)
- Solder pin contacts in nickel alloy
- Contact plating in active zone: Gold
- Glass insert
- Air leakage < 1.10^{-7} cm³/s under 1 bar of pressure differential
- Passivation or nickel plating

Overall dimensions - Hermetic versions

TVPS02Y JD38999/21Y

TVPS02YN JD38999/21N

Square flange receptacle

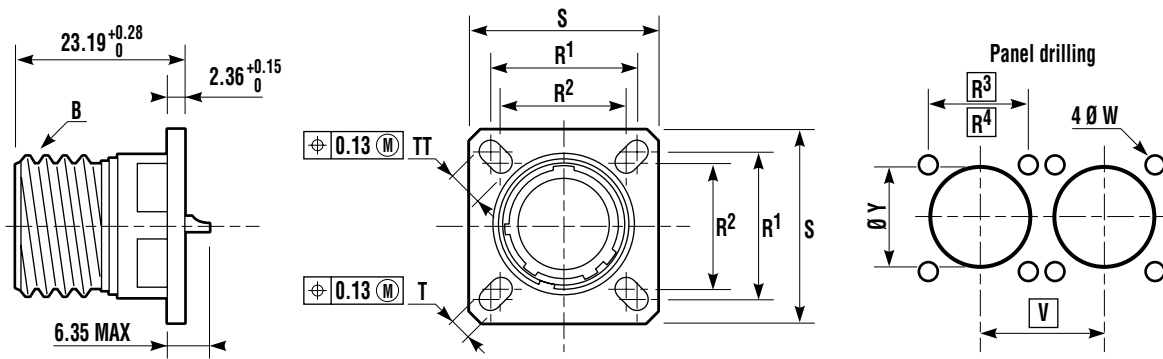

Shell size		B Thread Class 2A 0.1P-0.3L-TS (inches)	R ¹ (mm)	R ² (mm)	S ±0.25 (mm)	T +0.20 -0.13 (mm)	TT +0.20 -0.13 (mm)	Ø W +0 -0.25 (mm)	R ³ (mm)	R ⁴ (mm)	V Mini (mm)	Ø Y Mini (mm)
MIL-DTL-38999 Series III	Amphenol Socapex											
A	9	.6250	18.26	15.09	23.83	3.25	5.49	3.25	18.26	15.09	24.60	16.66
B	11	.7500	20.62	18.26	26.19	3.25	4.93	3.25	20.62	18.26	27.00	20.22
C	13	.8750	23.01	20.62	28.58	3.25	4.93	3.25	23.01	20.62	31.50	23.42
D	15	1.0000	24.61	23.01	30.96	3.25	4.39	3.25	24.61	23.01	34.50	26.59
E	17	1.1875	26.97	24.61	33.32	3.25	4.93	3.25	26.97	24.61	28.00	30.96
F	19	1.2500	29.36	26.97	36.53	3.25	4.93	3.25	29.36	26.97	40.50	32.94
G	21	1.3750	31.75	29.36	39.67	3.25	4.93	3.25	31.75	29.36	44.00	36.12
H	23	1.5000	34.93	31.75	42.88	3.91	6.15	3.81	34.93	31.75	47.00	39.29
J	25	1.6250	38.10	34.93	46.02	3.91	6.15	3.81	38.10	34.93	50.00	42.47

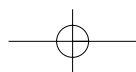

TVS07Y JD38999/23Y
 TVS07YN JD38999/23N
 Jam nut receptacle

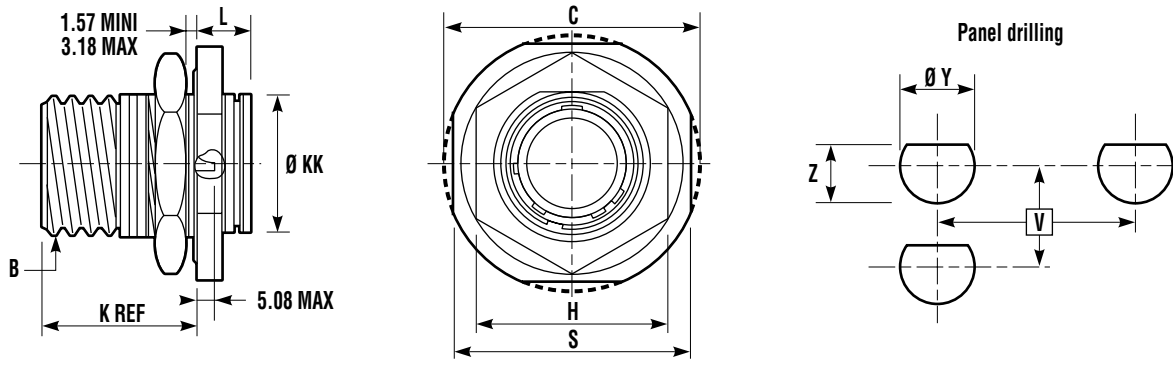

Shell size		B Thread Class 2A 0.1P-0.3L-TS (inches)	C Maxi (mm)	H/plats +0.043 -0.41 (mm)	L Maxi (mm)	Ø KK +0.28 0 (mm)	B ±0.25 (mm)	V Mini (mm)	Ø Y Mini (mm)	Z +0 -0.25 (mm)	Hex nut max torque value N.m
MIL-DTL-38999 Series III	Amphenol Socapex										
A	9	.6250	30.45	22.23	9.07	16.31	26.97	27.80	17.70	16.99	4.1
B	11	.7500	35.20	25.40	9.07	19.46	31.75	32.60	20.88	19.53	5.3
C	13	.8750	38.38	30.18	9.07	22.66	34.93	36.00	25.58	24.26	6.9
D	15	1.0000	41.55	33.32	9.07	25.86	38.10	39.60	28.80	27.53	8.6
E	17	1.1875	44.73	36.53	9.07	29.01	41.28	43.30	31.98	30.68	9.8
F	19	1.2500	49.50	39.67	9.68	32.21	46.02	47.00	35.16	33.86	10.9
G	21	1.3750	52.65	42.80	9.68	35.36	49.23	50.60	38.28	37.06	12.7
H	23	1.5000	65.85	46.02	9.68	38.56	52.37	54.20	41.50	40.01	13.8
J	25	1.6250	59.00	50.80	9.68	41.71	55.58	59.70	44.68	43.41	15

TVSIY JD38999/25Y
 TVSIYN JD38999/25N
 Solder mounting receptacle

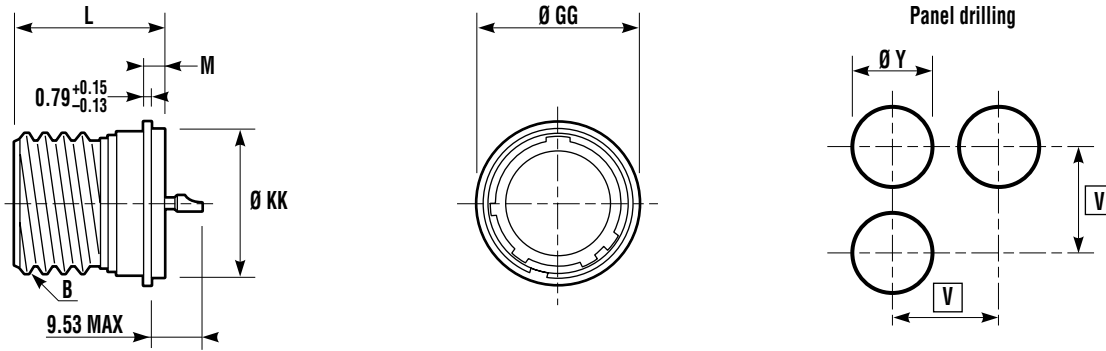

Shell size		B Thread Class 2A 0.1P-0.3L-TS (inches)	Ø GG +0.28 -0.25 (mm)	Ø KK +0.03 -0.13 (mm)	L +0.28 -0 (mm)	M +0.15 -0.13 (mm)	V Mini (mm)	Ø Y Mini (mm)
MIL-DTL-38999 Series III	Amphenol Socapex							
A	9	.6250	19.05	17.07	20.47	3.18	24.60	17.60
B	11	.7500	21.44	19.84	20.47	3.18	27.00	20.40
C	13	.8750	24.61	23.01	20.47	3.18	31.50	23.50
D	15	1.0000	27.79	26.19	20.47	3.18	24.50	26.70
E	17	1.1875	30.94	29.36	20.47	3.18	38.00	29.90
F	19	1.2500	33.32	31.75	20.47	3.18	40.50	32.30
G	21	1.3750	36.53	34.93	20.47	3.18	44.00	35.50
H	23	1.5000	39.70	38.10	21.29	3.96	47.00	38.60
J	25	1.6250	42.88	41.28	21.29	3.96	50.00	41.80

TVS-Y / TVS-YN HERMETIC RECEPTACLES

TV-CTV



Lanyard release plugs

Presentation

Lanyard release plugs meet the requirements of the standard MIL-DTL-38999 III standard, as well as the specific MIL-STD-1760 version that also meets MIL-STD-1760 and STANAG 3837 AA.

2 insert arrangements are available in MIL-STD-1760 lanyard release plugs, in accordance with the definition of BUS 1553 B standards in N coding (arrangement 25-20) and in A coding (arrangement 25-11) - Refer to pages 7 to 8 - insert arrangements marked with***

Other shell sizes and insert arrangements are also available in the MIL-DTL-38999 standard version. Please refer to pages 6 to 8 and consult us for further information.

Main characteristics

- Lanyard release plugs mate with standard TV receptacles, JD38999/20 and /24 types
- They accept MIL-C-85049 accessories
- They are 100% scoop-proof
- Applications: - Quick disconnect
- Weapon systems
- Ejector seats

Overall dimensions

Lanyard release plugs - MIL-STD-1760

Low profile version (ordering information on page 30)

TVFBRW JD38999/31W

Lanyard release plugs - MIL-STD-1760

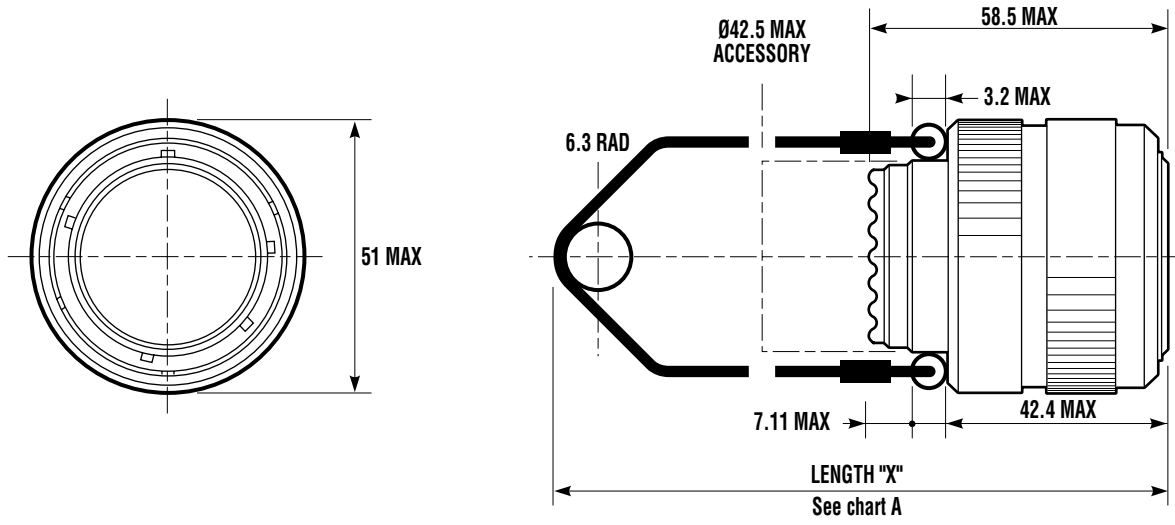

CHART A

Length "X" MIL-STD 1760 coding	mm
D	140
E	153
F	166
G	178
H	191
J	407
K	229
M	254
X	432

Other lengths are also available under TVFBRW proprietary designation. Consult us.

Lanyard release plugs

Standard version

(ordering information page 31)

885565...P JD38999/29W
 915565...P JD38999/29F
 885565...S JD38999/30W
 915565...S JD38999/30F

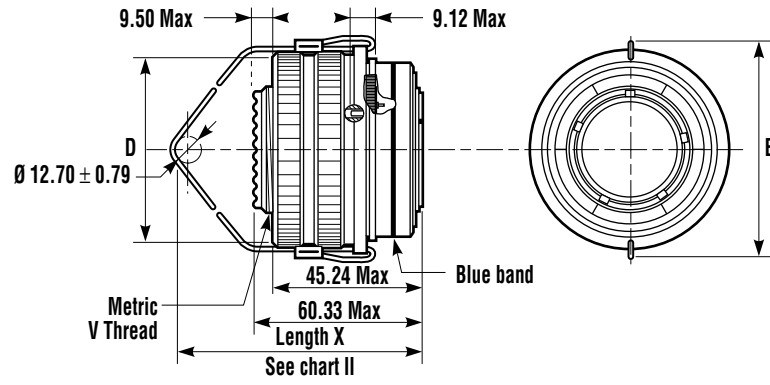

CHART I

Arrangement code	Insert arrangement
04	11-4
06	11-35
07	11-98
10	13-4
11	13-8
13	13-98
14	13-35
18	15-5
19	15-19
20	15-35
27	17-6
28	17-8
29	17-26
30	17-35
31	17-99
37	19-11
38	19-28
39	19-32
40	19-35
47	21-11
48	21-16
49	21-35
50	21-41
51	21-39
57	23-21
58	23-35
59	23-53
66	25-19
67	25-29
68	25-35
69	25-43
70	25-61
71	25-4
72	25-24

CHART II

Shell size		metric V thread	B Max (mm)	D Max (mm)
MIL-DTL-38999 Series III	Amphenol			
B	11	M15x1.0-6g	46.89	28.17
C	13	M18x1.0-6g	50.09	31.75
D	15	M22x1.0-6g	52.81	34.93
E	17	M25x1.0-6g	56.01	38.10
F	19	M28x1.0-6g	58.45	41.28
G	21	M31x1.0-6g	62.79	44.45
H	23	M34x1.0-6g	65.89	47.63
J	25	M37x1.0-6g	68.71	50.08

CHART III

Length "X" (mm)	Code MS/Amphenol
102	A
115	B
127	C
140	D
153	E
166	F
178	G
191	H
203	I
216	J
229	K
242	L
254	M
267	N
280	P
293	R
305	S
318	T
331	U
356	V
381	W
407	X
432	Y
458	Z

LANYARD RELEASE PLUGS

TV-CTV



Protection caps

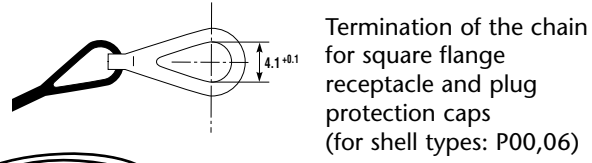
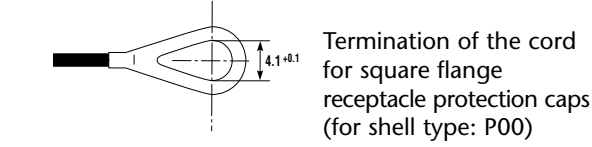
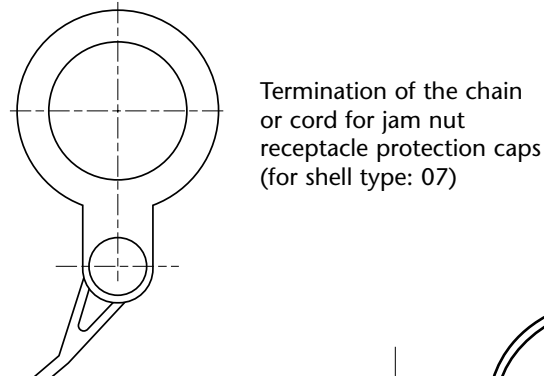
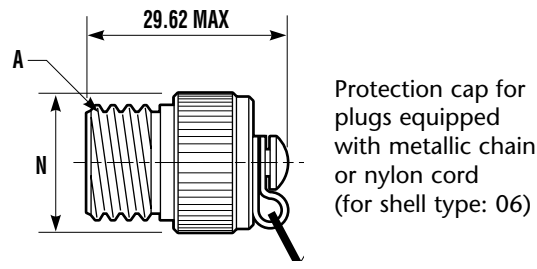
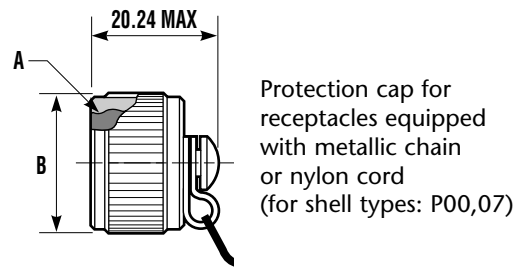

Termination of the cord for plugs protection caps (for shell type: 06)

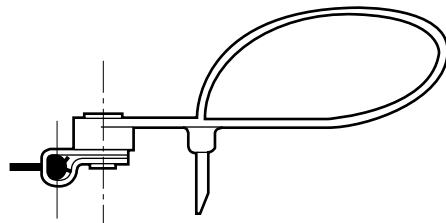

Cord length for plugs: 160 mm
 Cord length for receptacles: 105 mm
 Chain length for plugs: 127 mm
 Chain length for receptacles: 152 mm

Shell size		A Thread 0.1P-0.3L-TS Class 2B (inches)	B Dia Max (mm)	N Dia Max (mm)
MIL-DTL-38999 Series III	Amphenol Socapex			
A	9	.6250	22.23	22.73
B	11	.7500	25.40	25.40
C	13	.8750	28.58	29.74
D	15	1.0000	31.75	32.99
E	17	1.1875	36.53	36.47
F	19	1.2500	38.10	39.19
G	21	1.3750	41.28	42.42
H	23	1.5000	44.45	45.39
J	25	1.6250	47.63	48.62

Ordering information

CAP Series	B	EC	N	TV	W	15
Protection cap type EC: For square flange receptacle ER: For jam nut receptacle F: For plug						
Wire type N: Nylon cord Blank: Metallic chain						
Connector type						
Finish B: Bronze F: Electroless nickel plated, aluminium version W: Olive drab cadmium plated, aluminium version						
Corresponding connector shell size: 09/11/13/15/17/19/21/23/25						

For composite or stainless steel caps, please consult us

Plastic dust caps

For protection during transport and storage, plastic dust caps are available upon request.



Standard crimp and PCB contacts

Version	Contact Size	Pin contacts		Socket contacts	
		Proprietary No	Military No	Proprietary No	Military No
Standard	8 (coax)*	900130	M39029/60-367	900140	M39029/59-366
	8 (power)	900197	-	900217	-
		900198-91**	-	-	-
	10 (power)	900006	-	900046	-
	12 (coax)	900340	M39029/28-211	900350	M39029/75-416
	12	900005	M39029/58-365	900045	M39029/56-353
	16 (coax)	900132	M39029/76-424	900142	M39029/77-428
	16	900000	M39029/58-364	900040	M39029/56-352
	20	900001	M39029/58-363	900041	M39029/56-351
22D	900004	M39029/58-360	900044	M39029/56-348	
PCB	12	900238-91	-	-	-
	16	900240-91	-	900263	-
	20	900241	-	900251	-
	22	900245-91	-	900256	-

Above part numbers include standard 500 – cycle finish designation – gold plating over suitable underplate in accordance with MIL-C-39029.

* For use with RG180B/U and RG195A/U cable. For other size 8, 12 and 16 coaxial contacts please refer to data sheet E114.

** For arrangement 21-48 only

For other contacts (coaxial, triaxial, optical termini, PCB, thermocouple), please refer to data sheet E114

For details regarding size 8 piggy back grommets range, please refer to data sheet E114

Sealing plugs

Contact Size	Proprietary No	Military No
8 (Coax)	900024	NA
8 (Power)	900029	NA
10 (Power)	10.576225	NA
12	900023	MS27488-12
16	900020	MS27488-16
20	900021	MS27488-20
22D	900022	MS27488-22

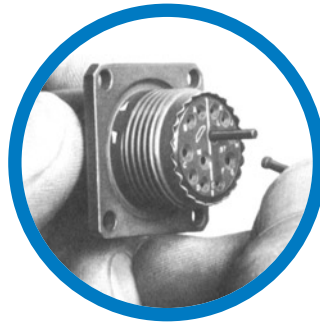

Holding support equipped with olive drab cadmium dummy receptacles

Amphenol Socapex reference: 809 931

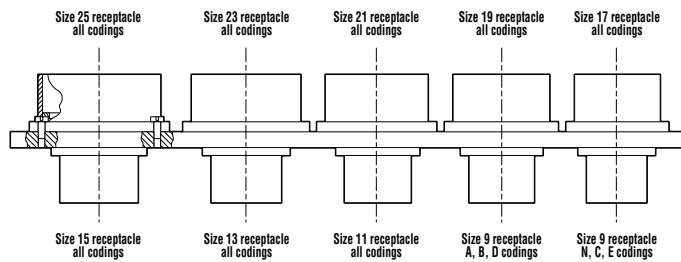

Torque value for rear accessories

For metallic accessories on metallic shells only.
For composite, please consult us.

Shell Size	Max. torque value N.m	Shell Size	Max. torque value N.m
9	11.30	19	22.60
11	11.30	21	28.30
13	17.00	23	28.30
15	22.60	25	28.30
17	22.60		

ACCESSORIES

TV-CTV



Crimping tools

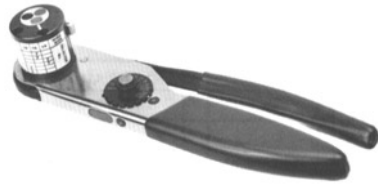

Contact size	Contact part number		Crimping tool		Positioner	
	Proprietary No	Military No	Proprietary No	Military No	Proprietary No	Military No
8 coax	Inner pin & socket		809 801	M22520/2-01	-	M22520/2-31
	Outer pin & socket		809 914	M22520/5-01	809 915	M22520/5-41
8 power	900 198/91	-	809 872	-	809 873	-
	900 197	-	809 872	-	809 873	-
	900 217	-	809 872	-	809 873	-
10 power	900 006	-				
	900 046	-				
12 coax	Inner pin & socket		809 801	M22520/2-01	809 932	M22520/2-34
	Outer pin & socket		809 926	M22520/31-01	809 927	M22520/31-02
12	900 005	M39029/58-365	809 857	M22520/1-01	809 858	M22520/1-04
	900 045	M39029/56-353	809 857	M22520/1-01	809 858	M22520/1-04
16 coax	Inner pin & socket		809 801	M22520/2-01	809 862	M22520/2-35
	Outer pin & socket		809 863	M22520/4-01	809 864	M22520/4-02
16	900 000	M39029/58-364	809 857	M22520/1-01	809 858	M22520/1-04
	900 040	M39029/56-352	809 857	M22520/1-01	809 858	M22520/1-04
20	900 001	M39029/58-363	809 857	M22520/1-01	809 858	M22520/1-04
			809 801	M22520/2-01	809 826	M22520/2-10
	900 041	M39029/56-351	809 857	M22520/1-01	809 858	M22520/1-04
22D			809 801	M22520/2-01	809 826	M22520/2-10
	900 004	M39029/58-360	809 801	M22520/2-01	809 810	M22520/2-09
	900 044	M39029/56-348	809 801	M22520/2-01	809 835	M22520/2-07

Insertion and removal tools



Plastic tools

Contact Size	Insertion tools		Removal tools	
	Proprietary No	Military No	Proprietary No	Military No
8 power	*	*	-	-
10 power	-	M81969/14-05	-	M81969/14-05
12	809 859	M81969/14-04	809 859	M81969/14-04
16	809 855	M81969/14-03	809 855	M81969/14-03
20	809 854	M81969/14-10	809 854	M81969/14-10
22D	809 856	M81969/14-01	809 856	M81969/14-01

* Manual insertion



Metallic tools

Contact size	Straight type		Angle type			
	Insertion tools Proprietary No	Removal tools Proprietary No	Insertion tools		Removal tools	
			Proprietary No	Military No	Proprietary No	Military No
8 power/coax	*	809 961	*	*	809 845	-
10 power	-	-	-	M81969/8-11	-	M81969/8-12
12	-	-	809 838	M81969/8-09	809 839	M81969/8-10
16	809 816	809 846	809 812	M81969/8-07	809 820	M81969/8-08
20	809 817	809 847	809 813	M81969/8-05	809 821	M81969/8-06
22D	809 819	809 849	809 815	M81969/8-01	809 823	M81969/8-02

* Manual insertion

Note: For lanyard release plugs, only use straight removal tools.

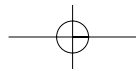

Amphenol designation - Composite and metallic versions

Series	TV	PS00	RF	23	53	P	A	-	-
TV: Metallic shell CTV: Composite shell									
Shell type Square flange receptacle: 175°C (O.D. cadmium): P00 200°C (nickel): PS00 Jam nut receptacle: 175°C (O.D. cadmium): 07 200°C (nickel): S07 Straight plug: 175°C (O.D. cadmium): 06 200°C (nickel): S06									
Shell material, finish and contact type <u>Composite</u> See pages 11 and 12 RW: Olive drab cadmium plated 175°C, crimp contacts WCI: Olive drab cadmium plated 175°C, PCB contacts WDW: Olive drab cadmium plated 175°C, wire-wrap contacts* RF: Electroless nickel plated 200°C, crimp contacts FCI: Electroless nickel plated 200°C, PCB contacts FDW: Electroless nickel plated 200°C, wire-wrap contacts* <u>Aluminium</u> See pages 13 to 15 RW: Olive drab cadmium plated 175°C, crimp contacts WCI: Olive drab cadmium plated 175°C, PCB contacts WDW: Olive drab cadmium plated 175°C, wire-wrap contacts* RF: Electroless nickel plated 200°C, crimp contacts FCI: Electroless nickel plated 200°C, PCB contacts FDW: Electroless nickel plated 200°C, wire-wrap contacts* <u>Stainless steel</u> See pages 13 to 15 RK: Passivated 200°C, firewall capability, crimp contacts KCI: Passivated 200°C, firewall capability, PCB contacts KDW: Passivated 200°C, firewall capability, wire-wrap contacts* RS: Nickel plated 200°C, firewall capability, crimp contacts SCI: Nickel plated 200°C, firewall capability, PCB contacts SDW: Nickel plated 200°C firewall capability, wire-wrap contacts* <u>Bronze</u> See pages 13 to 15 RB: 200°C, crimp contacts BCI: 200°C, PCB contacts BDW: 200°C, wire-wrap contacts*									
Shell size 09/11/13/15/17/19/21/23/25									
Contact arrangement See pages 6 to 8									
Contact type P: Pin (500 cycles) S: Socket (500 cycles) H: Pin (1500 cycles - CTV only) J: Socket (1500 cycles - CTV only)									
Polarization Blank for normal or A, B, C, D, E. See coding system on page 10									
Contacts Blank: Connector delivered with contacts LC: Connector delivered without contacts									
Deviation F404: Tinned PCB contacts W88 (for TVS06 RB only): Coupling nut conforms to CECC75 - 201 - 002A For other deviations (FXXX), please consult us.									

* For information on wire wrap contacts, please refer to data sheet E114.

ORDERING INFORMATION

TV-CTV

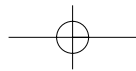

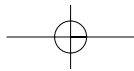

Military designation - Composite and metallic versions

Series	JD38999/	20	F	H	53	P	A
Shell type	20: Square flange receptacle 24: Jam nut receptacle 26: Straight plug						
Shell material and finish	Composite J: Olive drab cadmium plated 175°C M: Electroless nickel plated 200°C Aluminium W: Olive drab cadmium plated 175°C F: Electroless nickel plated 200°C Stainless steel K: Passivated 200°C, firewall capability S: Nickel plated 200°C, firewall capability						
Shell size	A B C D E F G H J MIL 09 11 13 15 17 19 21 23 25 Amphenol						
Contact arrangement	See pages 6 to 8						
Contact and connector type	A: Without pin contact B: Without socket contact P: With pin contacts S: With socket contacts						
Polarization:	N for normal or A, B, C, D, E. See coding system on page 10						

Amphenol designation - Data bus "Ground Plane" receptacle

Series	CTV	P 00	RG	W	15	05	P	-	LC
CTV: Composite shell (for TV metallic shell, please consult us)									
Shell type	Square flange receptacle: 175°C (O.D. cadmium): P 00 200°C (nickel): PS00 Jam nut receptacle: 175°C (O.D. cadmium): 07 200°C (nickel): S07								
Insert type	RG: conductive insert								
Shell finish	W: Olive drab cadmium plated 175°C F: Electroless nickel plated 200°C								
Shell size*	09/11/13/15/17/21/23/25								
Contact arrangement	See page 19								
Contact type	P: Pin S: Socket								
Polarization	Blank for normal or A,B. See coding system on page 10								
Contacts	LC: Connector delivered without contact.								

For other arrangement, shell, coding or deviation, please consult us
 * Shell size 9, available in aluminium (TV version) only.

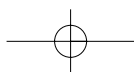

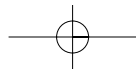

Amphenol designation - Hermetic versions

Series	TV	SI	YN	11	35	P	-
Shell type PS02: Square flange receptacle S07: Jam nut receptacle SI: Solder mounting receptacle							
Shell material and finish Y: Stainless steel passivated YN: Stainless steel nickel plated							
Shell size: 09/11/13/15/17/19/21/23/25							
Contact arrangement See pages 6 to 8 (insert arrangements marked with "Y")							
Contact type P: Pin							
Polarization Blank for normal or A, B, C, D, E. See coding system on page 10.							

Military designation - Hermetic versions

Connector type	JD38999/	25	N	B	35	P	N
Shell type 21: Square flange receptacle 23: Jam nut receptacle 25: Solder mounting receptacle							
Shell material and finish Y: Stainless steel passivated N: Stainless steel nickel plated							
Shell size A B C D E F G H J MIL 09 11 13 15 17 19 21 23 25 Amphenol							
Contact arrangement See pages 6 to 8 (insert arrangements marked with "Y")							
Contact type P: Pin.							
Polarization: N for normal or A, B, C, D, E. See coding system on page 10							

ORDERING INFORMATION

TV-CTV

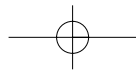
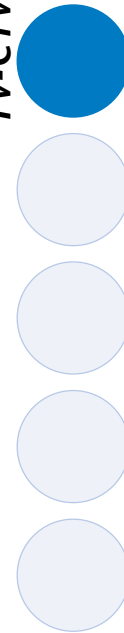

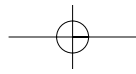

Amphenol designation - MIL-STD-1760 lanyard release plugs

Low profile version

Series	TV	FB	RW	25-11	P	E
FB: MIL-STD-1760 lanyard release plug						
RW: Olive drab cadmium plated						
Arrangement 25-11, 25-20: see pages 6 to 8						
Contact type and polarization G: 25-11 arrangement, pin contacts only (see "polarization chart" on page 31) P: 25-20 arrangement, pin contacts only (see "polarization chart" on page 31)						
Lanyard length D: 140 mm E: 153 mm F: 166 mm G: 178 mm H: 191 mm K: 229 mm M: 254 mm J: 407 mm X: 432 mm Other lengths are available upon request						

Military designation - MIL-STD-1760 lanyard release plugs

Low profile version

Series	JD38999/	31	W	E	11	N	1
Shell and contact type 31: Plug with pin contacts, per MIL-STD-1760							
Shell finish W: Olive drab cadmium plated 175°C							
Lanyard length D: 140 mm E: 153 mm F: 166 mm G: 178 mm H: 191 mm K: 229 mm M: 254 mm J: 407 mm X: 432 mm							
Contact arrangement 11: 25-11 arrangement 20: 25-20 arrangement							
Polarization: N for 25-20 arrangement. See coding on page 10 A for 25-11 arrangement.							
Plug locking ring type 1: Ø 51mm (low profile) 2: Ø 68mm (please consult us)							



Amphenol 30

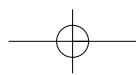

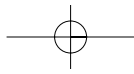

Amphenol designation - Lanyard release plugs

Standard version

Shell finish 88: Olive-drab cadmium plated 91: Nickel plated	88	5565	20	K	P
Connector type					
Shell size and arrangement code See chart I on page 23 Others, please consult us					
Lanyard length A to Z code (see chart III on page 23)					
Contact type and polarization See chart below					

Polarization

MS code	Socket contact code Amphenol	MS code	Pin contact code Amphenol
SN	S (normal)	PN	P (normal)
SA	H	PA	G
SB	J	PB	I
SC	L	PC	K
SD	N	PD	M
SE	T	PE	R

Military designation - Lanyard release plugs

Standard version

Connector type	JD38999/	29	W	D	35	E	N
Shell and contact type 29: Plug with pin contacts 30: Plug with socket contacts							
Shell finish W: Olive drab cadmium plated F: Nickel plated							
Shell size A* B C D E F G H J MIL 09* 11 13 15 17 19 21 23 25 Amphenol * Please consult us							
Contact arrangement See chart I on page 23							
Lanyard length A to Z code (see chart III on page 23)							
Polarization N for normal or A, B, C, D, E. See coding on page 10							

ORDERING INFORMATION

TV-CTV

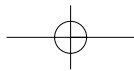

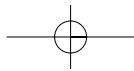

CROSS REFERENCES

SHELL MATERIAL	MIL-DTL-38999 Series III	AMPHENOL
Composite shell	JD38999/20J X XX A °	CTVP00RW □ □ ## P ^ LC
		CTVP00WCI □ □ ## P ^ LC
		CTVP00WDW □ □ ## P ^ LC
	JD38999/20M X XX A °	CTVPS00RF □ □ ## P ^ LC
		CTVPS00FCI □ □ ## P ^ LC
		CTVPS00FDW □ □ ## P ^ LC
	JD38999/24J X XX A °	CTV07RW □ □ ## P ^ LC
		CTV07WCI □ □ ## P ^ LC
		CTV07WDW □ □ ## P ^ LC
	JD38999/24M X XX A °	CTVS07RF □ □ ## P ^ LC
		CTVS07FCI □ □ ## P ^ LC
		CTVS07FDW □ □ ## P ^ LC
	CTV06RW □ □ ## P ^ LC	
JD38999/26M X XX A °	CTVS06RF □ □ ## P ^ LC	
JD38999/20W X XX A °	TVP00RW □ □ ## P ^ LC	
	TVP00WCI □ □ ## P ^ LC	
	TVP00WDW □ □ ## P ^ LC	
JD38999/20F X XX A °	TVPS00RF □ □ ## P ^ LC	
	TVPS00FCI □ □ ## P ^ LC	
	TVPS00FDW □ □ ## P ^ LC	
JD38999/24W X XX A °	TV07RW □ □ ## P ^ LC	
	TV07WCI □ □ ## P ^ LC	
	TV07WDW □ □ ## P ^ LC	
JD38999/24F X XX A °	TVS07RF □ □ ## P ^ LC	
	TVS07FCI □ □ ## P ^ LC	
	TVS07FDW □ □ ## P ^ LC	
JD38999/26W X XX A °	TV06RW □ □ ## P ^ LC	
JD38999/26F X XX A °	TVS06RF □ □ ## P ^ LC	
JD38999/20K X XX A °	TVPS00RK □ □ ## P ^ LC	
	TVPS00KCI □ □ ## P ^ LC	
	TVPS00KDW □ □ ## P ^ LC	
JD38999/20S X XX A °	TVPS00RS □ □ ## P ^ LC	
	TVPS00SCI □ □ ## P ^ LC	
	TVPS00SDW □ □ ## P ^ LC	
JD38999/24K X XX A °	TVS07RK □ □ ## P ^ LC	
	TVS07KCI □ □ ## P ^ LC	
	TVS07KDW □ □ ## P ^ LC	
JD38999/24S X XX A °	TVS07RS □ □ ## P ^ LC	
	TVS07SCI □ □ ## P ^ LC	
	TVS07SDW □ □ ## P ^ LC	
JD38999/26K X XX A °	TVS06RK □ □ ## P ^ LC	
JD38999/26S X XX A °	TVS06RS □ □ ## P ^ LC	
Aluminium bronze shell		TVPS00RB □ □ ## P ^
		TVPS00BCI □ □ ## P ^
		TVPS00BDW □ □ ## P ^
		TVS07RB □ □ ## P ^
		TVS07BCI □ □ ## P ^
Hermetic receptacles	JD38999/21Y X XX P °	TVPS02Y □ □ ## P ^
	JD38999/21N X XX P °	TVPS02YN □ □ ## P ^
	JD38999/23Y X XX P °	TVS07Y □ □ ## P ^
	JD38999/23N X XX P °	TVS07YN □ □ ## P ^
	JD38999/25Y X XX P °	TVSIY □ □ ## P ^
	JD38999/25N X XX P °	TVSIYN □ □ ## P ^

As example, male version without contact (except for bronze and hermetic male versions with contacts).

CAPTION	MIL-DTL-38999 Series III P/N	AMPHENOLP/N
Shell size	X	□ □
Insert arrangement	XX	##
Polarization, rotation of secondary keyways	°	^

Do not hesitate to contact us for further information



Amphenol

Amphenol Socapex
Mil/Aero & Industrial Business Unit

948, Promenade de l'Arve - BP 29
F - 74311 Thyez Cedex
Tel.: +33 (0)4 50 89 28 00 - Fax: +33 (0)4 50 96 19 41
<http://www.amphenol-socapex.com>

Sales office in Paris
Tel.: +33 (0)1 49 05 30 00 - Fax: +33 (0)1 49 05 30 43

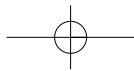

E113/C The information given in this document is as a guideline only. We reserve the right to modify our products in any way we deem necessary. Any duplication is prohibited, unless approved in writing. Médiastyle +33 (0) 1 46 31 36 36

Amphenol



X-ON Electronics

Largest Supplier of Electrical and Electronic Components

Click to view similar products for [Circular MIL Spec Connector](#) category:

Click to view products by [Amphenol](#) manufacturer:

Other Similar products are found below :

[89075GULPR](#) [0025-262-542](#) [0025-264-3014](#) [58-570121-04S](#) [0134-213-1208](#) [0134-213-2209](#) [0025-258-000](#) [60-042022-07P](#) [60-042022-19P](#)
[60-042022-23P](#) [60-042217-10P](#) [0114-201-1278](#) [012-0467-000](#) [602GB06EG24-61SN](#) [0134-201-1207](#) [0134-213-1006](#) [6104-207-2302](#) [6104-](#)
[208-1902](#) [61-168211-04P](#) [61-168617-10P](#) [6131-202-19149P](#) [6131-204-21149P](#) [6131-208-13149P](#) [6131-209-17149P](#) [6131-210-11149P](#) [6131-](#)
[211-19149P](#) [6131-216-19149P](#) [6131-259-21149P](#) [6131-259-23149P](#) [6131-265-17149P](#) [6131-265-19149P](#) [CS3100A18-1P-472](#) [CS3100A-36-](#)
[77P](#) [CS3101A-16-55P](#) [CS3102A-10SL-55P](#) [CS3102A-14S-58P](#) [CS3102A-32-17P](#) [CS3102A32-25S](#) [CS3102C18-4P-472](#)
[CS3106A10SL3S004](#) [CS3106A-18-73S](#) [CS3108A-14S-52S](#) [CS3108A-28-51S](#) [6162-233-1277](#) [6162-324-1231](#) [M243082296Z](#)
[M2884010AC1S1](#) [CT0-24-10SC](#) [CT0M20-7PCAU](#) [M28840/17AC1G3](#)