

# gen4-ESP32-RGB Series



gen4-ESP32-XX (Non-touch)\*

gen4-ESP32-XXT (Resistive touch)\*

gen4-ESP32-XXCT (Capacitive touch)\*

gen4-ESP32-XXCT-CLB (Capacitive touch w/ Cover Lens Bezel)\*

gen4-ESP32-70[T/CT/CT-CLB]-WVA (7.0" Wide Viewing Angle Variants)

\* - XX indicates the display size: 43 (4.3"), 50 (5.0") or 70 (7.0")

## Datasheet

Revision 1.0

Copyright © 2023 4D Systems

Content may change at any time. Please refer to the resource centre for latest documentation.

# Contents

---

1. Description	4
2. Features	6
3. Hardware Overview	8
4. Hardware Interface - Pins	11
4.1. Serial Ports - 3.3V TTL Level	11
4.2. I2C Port - 3.3V TTL Level	11
4.3. SPI Port - 3.3V TTL Level	11
4.4. General Purpose I/O	12
4.5. System Pins	16
4.6. Accessing Other GPIO Pins - Hardware Mods Required	17
5. Module Features	19
5.1. ESP32-S3R8 Processor	19
5.2. Chipsets used	19
5.3. SD/SDHC Memory Cards	20
5.4. microSD Socket Usage	21
5.5. FAT16 vs FAT32	22
5.6. Wide Viewing Angle (WVA)	22
6. Display/Module Precautions	23
7. Hardware Tools	24
7.1. 4D-UPA	24
7.2. USB-C Cable	26
8. Workshop4 IDE	27
8.1. Tools available inside the Workshop IDE	27
9. Programming Language	27
10. Display Module Part Numbers	28
11. Cover Lens Bezel - Tape Spec	29
12. FFC Cable	29
13. Starter Kit	31

14. 4.3" Mechanical Details (Non-Touch, Resistive Touch, Capacitive Touch)	32
15. 4.3" Mechanical Details (Capacitive Touch with CLB)	33
16. 5.0" Mechanical Details (Non-Touch, Resistive Touch, Capacitive Touch)	34
17. 5.0" Mechanical Details (Capacitive Touch with CLB)	35
18. 7.0" Mechanical Details (Non-Touch, Resistive Touch, Capacitive Touch)	36
19. 7.0" Mechanical Details (Capacitive Touch with CLB)	37
20. Schematic Circuit Details	38
21. Specifications	39
22. Revision History	43
23. Legal Notice	44
23.1. Proprietary Information	44
23.2. Disclaimer of Warranties & Limitations of Liabilities	44

# 1. Description

The gen4-ESP32 Series of Intelligent Display Modules, is designed and manufactured by 4D Systems.

These display modules are available in 4.3", 5.0" and 7.0", offering an RGB Interface between the ESP32-S3R8 Processor, and the 800x480 resolution TFT LCD Displays. The 4.3" and 5.0" displays are an IPS TFT LCD's, and the 7.0" is a TN TFT LCD. The 7.0" is also available in WVA (Wide Viewing Angle), which brings IPS like performance to a TN display.

Available in Non-Touch, Resistive Touch, Capacitive Touch, and Capacitive Touch with Cover Lens Bezel (CLB).

The ESP32-S3R8 Processor makes available multiple GPIO which include UART, SPI, I2C, PWM and Analog functionality, while also serving interfaces for the LCD Touch screen, Real Time Clock, Quad SPI Flash, microSD Card, 8bit IO Expander and Native USB-C.

The user interface to the gen4-ESP32 series is a 30-pin FPC/ZIF socket, designed for a 30-way 0.5mm pitch FFC cable, for easy and simple connection to an application or motherboard, or for connecting to accessory boards for a range of functionality advancements.

This series of boards is compatible with the 4D Systems Workshop4 IDE, utilising the Espressif compiler and 4D Systems purpose built libraries, allowing a feature rich design and programming experience.

Any code designed and written to run on other 4D Systems display modules, such as modules featuring Goldelox, Picaso, Pixxi or Diablo16 Graphics Processors, are unfortunately not compatible with the gen4-ESP32 range due to being a totally different processor family. However, please contact 4D Systems Support Team for assistance if you are planning on migrating from a different 4D Systems display model, as there are some similarities between them - such as the graphics, however a majority of the coding will have to be adapted.

From a mechanical perspective, these gen4-ESP32 modules are physically the same mounting size as other gen4 products by 4D Systems. The only difference is the circuitry used. Overall thickness of these gen4-ESP32 modules are greater than other gen4 products, due to the USB-C connector and coin cell battery holder for the RTC. Typically where ever a different gen4 module had been mounted, a gen4-ESP32 module could fit in the same location.

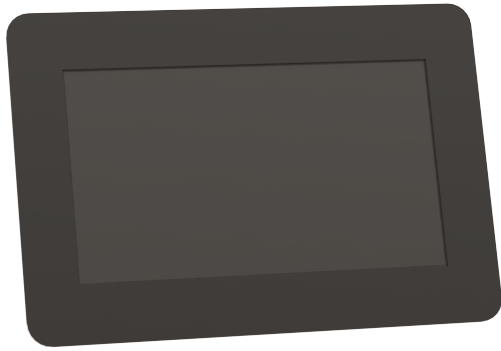

*gen4-ESP32-43CT-CLB Front*

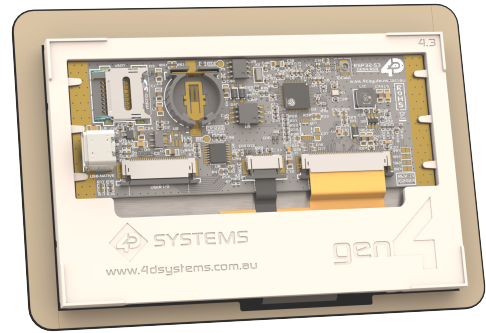

*gen4-ESP32-43CT-CLB Rear*



*gen4-ESP32-43CT Front*

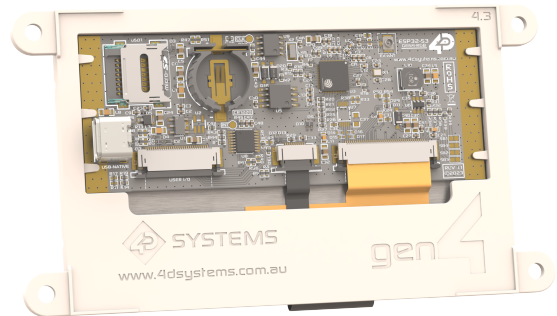

*gen4-ESP32-43CT Rear*

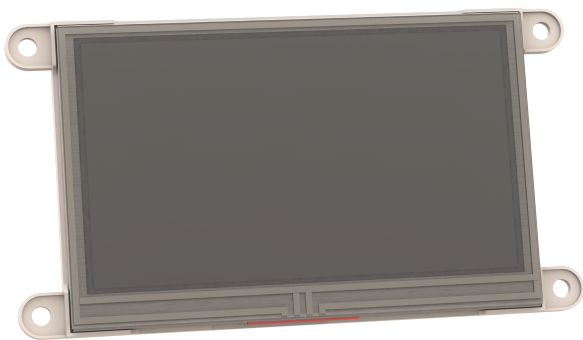

*gen4-ESP32-43T Front*

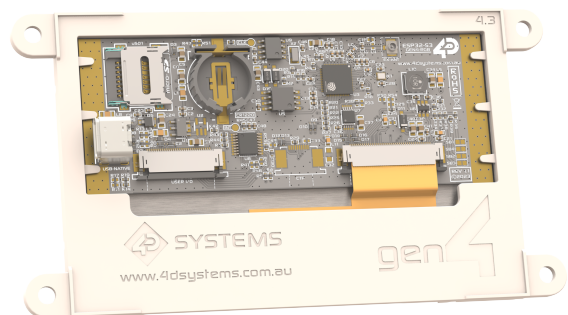

*gen4-ESP32-43T Rear*

## 2. Features

- Powerful ESP32 Graphics Processor by Espressif.
- 800x480 resolution displays utilising RGB-565 colours.
- IPS TFT LCD display for 4.3" and 5.0" and TN TFT LCD display for 7.0" (WVA available for 7.0").
- Available in Non-Touch, Resistive Touch, Capacitive Touch, and Capacitive Touch with Cover Lens Bezel (CLB).
- 16MB of External Quad SPI Flash.
- 8MB of Internal Octal SPI PSRAM.
- 2 native GPIO dedicated to I2C only (As they are used internally on the board) (GPIO17/18).
- Up to 17 GPIO of which
  - Up to 8 GPIO via IO Expander capable of Digital Input/Output (EXT-GPIO0 - EXT-GPIO7).
    - 2 of which are unavailable unless Touch Reset/Interrupt is hardware disabled (EXT-GPIO6/7).
  - 4 native GPIO dedicated to SPI (Shared with microSD card) - CS pin (GPIO38) can be GPIO if SPI not used, and all 4 SPI pins can be GPIO if microSD card not utilised (GPIO38, GPIO11/12/13).
  - 2 native GPIO dedicated to Native USB-C functionality (GPIO19/20) unless that is hardware disabled, it is then available as GPIO.
  - 1 native GPIO available after boot (GPIO0), strapping pin.
  - 2 native GPIO available if the UART is not required (GPIO43/44)
- Serial UART (GPIO43/44), and up to 3 more UART's available by utilising available GPIO.
- On-board Real Time Clock with battery backup (CR1220).
- 30pin FPC connection, for all signals, power, communications, GPIO and UART programming.
- Latch-type micro-SD memory card connector for multimedia storage and data logging purposes.
- Display full colour images, animations, icons and video clips.
- 4.0V to 6.0V range operation (single supply).
- 4x mounting tabs with 4.0mm holes for mechanical mounting using M4 screws (non CLB models only).
- 3M Adhesive around perimeter of Cover Lens Bezel for mounting the CTP-CLB model.
- RoHS and REACH compliant.
- CE/EMC and UKCA compliance pending.
- PCB is UL 94V-0 Flammability Rated.

## • Module dimensions:

- (4.3" non-Touch): 127.6 x 69.3 x 11.8mm
- (4.3" Resistive Touch): 127.6 x 69.3 x 12.9mm
- (4.3" Capacitive Touch): 127.6 x 69.3 x 13.2mm
- (4.3" Capacitive Touch w/ CLB): 123.0 x 84.5 x 13.5mm
- (5.0" non-Touch): 142.8 x 77.9 x 11.7mm
- (5.0" Resistive Touch): 142.8 x 77.9 x 12.9mm
- (5.0" Capacitive Touch): 142.8 x 77.9 x 13.4mm
- (5.0" Capacitive Touch w/ CLB): 140.7 x 93.8 x 13.4mm
- (7.0" non-Touch): 187.0 x 102.1 x 12.3mm
- (7.0" Resistive Touch): 187.0 x 102.1 x 13.4mm
- (7.0" Capacitive Touch): 187.0 x 102.1 x 14.0mm
- (7.0" Capacitive Touch w/ CLB): 190.1 x 121.9 x 14.0mm

## • Weighing (approximately):

- (4.3" non-Touch): ~ 72g
- (4.3" Resistive Touch): ~ 85g
- (4.3" Capacitive Touch): ~ 89g
- (4.3" Capacitive Touch w/ CLB): ~ 93g
- (5.0" non-Touch): ~ 84g
- (5.0" Resistive Touch): ~ 102g
- (5.0" Capacitive Touch): ~ 107g
- (5.0" Capacitive Touch w/ CLB): ~ 112g
- (7.0" non-Touch): ~ 176g
- (7.0" Resistive Touch): ~ 211g
- (7.0" Capacitive Touch): ~ 215g
- (7.0" Capacitive Touch w/ CLB): ~ 228g

 **Note**

The weights and dimensions provided for 7.0" models applies for both WVA and non-WVA variants.

### 3. Hardware Overview

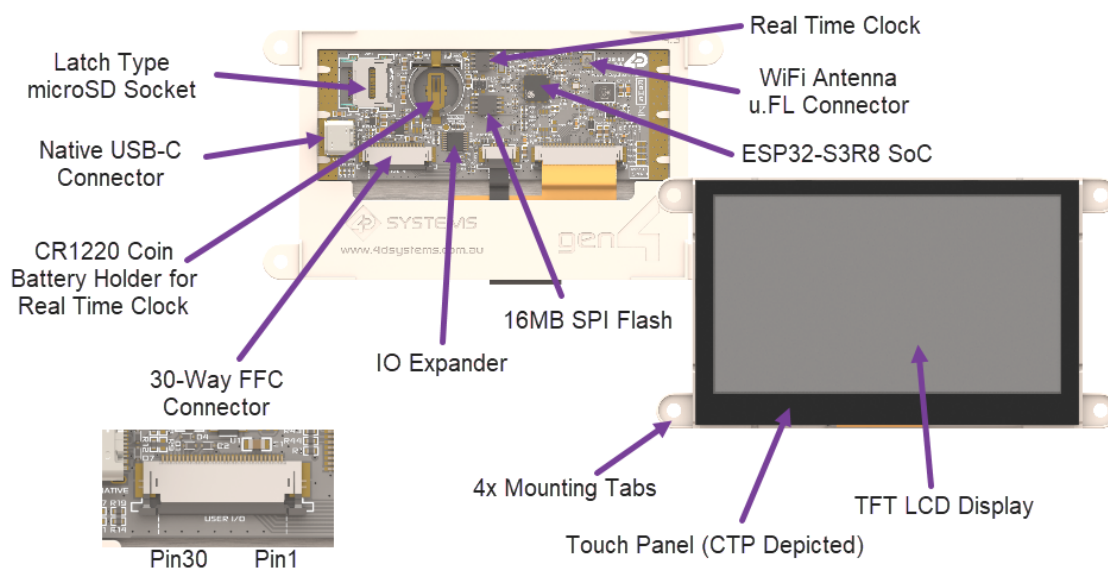

Hardware Layout (4.3" CTP Module depicted)

Pin	Symbol	I/O	Description
1	GND	P	Supply Ground
2	I2C-SDA	I/O	Dedicated I2C pin as its also used internally, SDA - 3.3V logic. This module is Master (GPIO17)
3	I2C-SCL	I/O	Dedicated I2C pin as its also used internally, SCL - 3.3V logic. This module is Master (GPIO18)
4	EXT-GPIO0	I/O	General Purpose I/O pin via IO Expander (Digital Input/Output only). This pin has 3.3V logic and is 5V tolerant for Input
5	EXT-GPIO1	I/O	General Purpose I/O pin via IO Expander (Digital Input/Output only). This pin has 3.3V logic and is 5V tolerant for Input
6	EXT-GPIO2	I/O	General Purpose I/O pin via IO Expander (Digital Input/Output only). This pin has 3.3V logic and is 5V tolerant for Input
7	EXT-GPIO3	I/O	General Purpose I/O pin via IO Expander (Digital Input/Output only). This pin has 3.3V logic and is 5V tolerant for Input
8	EXT-GPIO4	I/O	General Purpose I/O pin via IO Expander (Digital Input/Output only). This pin has 3.3V logic and is 5V tolerant for Input
9	EXT-GPIO5	I/O	General Purpose I/O pin via IO Expander (Digital Input/Output only). This pin has 3.3V logic and is 5V tolerant for Input
10	EXT-GPIO6*	I/O	N/C unless hardware mod, then General Purpose I/O pin via IO Expander (Digital Input/Output only). This pin has 3.3V logic and is 5V tolerant for Input
11	EXT-GPIO7*	I/O	N/C unless hardware mod, then General Purpose I/O pin via IO Expander (Digital Input/Output only). This pin has 3.3V logic and is 5V tolerant for Input



Pin	Symbol	I/O	Description
12	GPIO38/ SPI-CS	I/O	General Purpose Input/Output, SPI CS capable if using SPI Bus. 3.3V Logic.
13	GPIO11/SPI- MOSI	I/O/A	SPI-MOSI (shared with uSD card) however if uSD not required this can be a General Purpose Input/Output capable of Analog, 3.3V logic
14	GPIO12/ SPI-SCLK	I/O/A	SPI-SCLK (shared with uSD card) however if uSD not required this can be a General Purpose Input/Output capable of Analog, 3.3V logic
15	GPIO13/SPI- MISO	I/O/A	SPI-MISO (shared with uSD card) however if uSD not required this can be a General Purpose Input/Output capable of Analog, 3.3V logic
16	GPIO20*	I/O/A	N/C unless hardware mod, then General Purpose Input/Output pin capable of Analog, 3.3V logic
17	GPIO19*	I/O/A	N/C unless hardware mod, then General Purpose Input/Output pin capable of Analog, 3.3V logic
18	NC	-	Not Connected
19	GPIO0	I/O	Available after boot, GPIO0 is used for Programming and Boot Strapping. General Purpose Input/Output, 3.3V logic
20	3.3V	P	3.3V Output for User, connected to system 3.3V bus. Excessive draw will affect system stability. 100mA-200mA draw is OK
21	GND	P	Supply Ground
22	EN-RST	I	Master Reset/Enable signal. Internally pulled up to 3.3V via a 10K resistor. Low will disable the chip, High will activate the chip. Used by a UART programmer for programming sequence.
23	U0RXD	I	Asynchronous Serial Receive pin, 3.3V TTL level. Connect this pin to the Transmit (Tx) signal of other serial devices. Used in conjunction with the U0TXD pin for UART programming or communications. This pin is 3.3V Logic only. (GPIO44)
24	U0TXD	O	Asynchronous Serial Transmit pin, 3.3V TTL level. Connect this pin to the Receive (Rx) signal of other serial devices. Used in conjunction with the U0RXD pin for UART programming or communications. This pin is 3.3V Logic only. (GPIO43)
25	GND	P	Supply Ground
26	5V IN	P	Main Voltage Supply +ve input pin. Reverse polarity protected. The range is 4.0V to 6.0V, nominal 5.0V.
27	5V IN	P	Main Voltage Supply +ve input pin. Reverse polarity protected. The range is 4.0V to 6.0V, nominal 5.0V.
28	5V IN	P	Main Voltage Supply +ve input pin. Reverse polarity protected. The range is 4.0V to 6.0V, nominal 5.0V.
29	5V IN	P	Main Voltage Supply +ve input pin. Reverse polarity protected. The range is 4.0V to 6.0V, nominal 5.0V.
30	GND	P	Supply Ground

 **Note**

1. **I** = Input, **O** = Output, **P** = Power, **A** = Analog Input
2. It is recommended to connect at least 2 or more 5V IN pins to a stable 5V DC power supply, as well as at least 2 or more GND pins, especially important for the 7" display.
3. Please refer to the Espressif ESP32-S3 datasheet for specific detail on the capability of the native ESP32-S3 GPIO, in conjunction with the schematic of this module. Not all GPIO are native ESP32-S3, some are via a Texas Instruments I2C IO Expander (TCA9554APWR).

---

## 4. Hardware Interface - Pins

This section describes in detail the hardware interface pins of the module.

### 4.1. Serial Ports - 3.3V TTL Level

The gen4-ESP32 Series has a single serial UART, which is broken out to the 30-way FFC connector on this module (Pins 23 and 24, GPIO43/44). The module is capable of turning the available native GPIO into more serial UART's also, based on the functionality of the ESP32-S3 processor. Please refer to the Espressif Datasheet for the ESP32-S3 for more detail. <https://docs.espressif.com/projects/esp-idf/en/latest/esp32s3/api-reference/peripherals/uart.html>

Depending which on-board peripherals are used, such as the microSD socket, or the native USB-C, up to 3 additional serial UART's could potentially be configured using GPIO38, GPIO11, GPIO12, GPIO13, GPIO20 and GPIO19.

The module can be programmed over UART (rather than native USB-C) utilising the U0RXD/U0TXD pins, in conjunction with EN-RST and GPIO0. Please refer to the 4D-UPA Programmer, in the Hardware Tools section.

### 4.2. I2C Port - 3.3V TTL Level

The gen4-ESP32 Series has 2 dedicated I2C pins (Pins 2 and 3) available on the 30-way FFC connector, due to I2C being utilised internally for the Touch, Real Time Clock, and IO Expander. These pins can be utilised by the User for general purpose I2C devices also. The gen4-ESP32 module is Master in terms of the I2C bus, so only Slave I2C devices can be added. High traffic I2C devices may cause issues with on board devices.

### 4.3. SPI Port - 3.3V TTL Level

The gen4-ESP32 Series has an SPI Port available to the user, which is shared with the micro-SD connector, however has a dedicated CS pin for the User to connect a single SPI device. Further SPI devices could be added, utilising other spare GPIO to serve as additional CS pins.

## 4.4. General Purpose I/O

There are up to 17 general-purpose Input/Output (GPIO) pins available to the user. Some of these GPIO are native to the ESP32-S3 processor, and some are via an I2C IO Expander.

ESP32-S3 Pin Configurations GPIO					
GPIO/Pin Name	Digital Input	Digital Output	Analog Read	SPI	UART
EXT-GPIO0	Yes	Yes			
EXT-GPIO1	Yes	Yes			
EXT-GPIO2	Yes	Yes			
EXT-GPIO3	Yes	Yes			
EXT-GPIO4	Yes	Yes			
EXT-GPIO5	Yes	Yes			
EXT-GPIO6	Yes**	Yes**			
EXT-GPIO7	Yes**	Yes**			
GPIO38	Yes	Yes		Yes (CS)	Yes*
GPIO11	Yes*	Yes*	Yes*	Yes (MOSI)	Yes*
GPIO12	Yes*	Yes*	Yes*	Yes (SCLK)	Yes*
GPIO13	Yes*	Yes*	Yes*	Yes (MISO)	Yes*
GPIO20	Yes**	Yes**	Yes**		Yes**
GPIO19	Yes**	Yes**	Yes**		Yes**
GPIO0	Yes	Yes			
GPIO43	Yes*	Yes*			Yes (TX)
GPIO44	Yes*	Yes*			Yes (RX)

### Note

1. GPIO marked with \* are only available if the hardware is configured to do so, as by default they will have other functions.
2. GPIO marked with \*\* require hardware modifications to achieve, please refer to the [Hardware Mods section](#) for more detail.

Please refer to the Espressif ESP32-S3 datasheet for information on how to configure the native GPIO for various functions, such as Digital-Input/Digital-Output, Analog Input and SPI.

**EXT-GPIO0**

General purpose I/O pin, connected to the ESP32-S3 via an I2C IO Expander. Capable of Digital Input and Output only. 5V tolerant for input, 3.3V logic level output.

**EXT-GPIO1**

General purpose I/O pin, connected to the ESP32-S3 via an I2C IO Expander. Capable of Digital Input and Output only. 5V tolerant for input, 3.3V logic level output.

**EXT-GPIO2**

General purpose I/O pin, connected to the ESP32-S3 via an I2C IO Expander. Capable of Digital Input and Output only. 5V tolerant for input, 3.3V logic level output.

**EXT-GPIO3**

General purpose I/O pin, connected to the ESP32-S3 via an I2C IO Expander. Capable of Digital Input and Output only. 5V tolerant for input, 3.3V logic level output.

**EXT-GPIO4**

General purpose I/O pin, connected to the ESP32-S3 via an I2C IO Expander. Capable of Digital Input and Output only. 5V tolerant for input, 3.3V logic level output.

**EXT-GPIO5**

General purpose I/O pin, connected to the ESP32-S3 via an I2C IO Expander. Capable of Digital Input and Output only. 5V tolerant for input, 3.3V logic level output.

**EXT-GPIO6**

By default this pin is not available to the User, and is not hardware connected to the 30-way FFC connector. By default this pin is used internally to serve the Capacitive Touch INT signal. This can however be configured to be connected to the 30-way FFC connector if this feature is not required. When modified in hardware (refer to the [Hardware Mods section](#)), this pin is a General purpose I/O pin, connected to the ESP32-S3 via an I2C IO Expander. Capable of Digital Input and Output only. 5V tolerant for input, 3.3V logic level output.

**EXT-GPIO7**

By default this pin is not available to the User, and is not hardware connected to the 30-way FFC connector. By default this pin is used internally to serve the Capacitive Touch RESET signal. This can however be configured to be connected to the 30-way FFC connector if this feature is not required. When modified in hardware (refer to the [Hardware Mods section](#)), this pin is a General purpose I/O pin, connected to the ESP32-S3 via an I2C IO Expander. Capable of Digital Input and Output only. 5V tolerant for input, 3.3V logic level output.

### **GPIO38/SPI-CS**

This pin is typically used as a CS select pin for the SPI Bus, however can be used as a GPIO pin. It is a native ESP32-S3 GPIO pin, capable of Digital Input and Output only. It is 3.3V tolerant only and 3.3V logic level.

### **GPIO11/SPI-MOSI**

This pin is shared with the micro-SD connector, and therefore typically must remain as a MOSI SPI pin. Used in conjunction with the GPIO38/SPI-CS pin, this can be fully utilised by the User as a SPI bus for external devices. If the micro-SD card is not required and not utilised, this pin can be utilised as a GPIO pin. It is native to the ESP32-S3 and can be utilised for Digital Input and Output, as well as Analog Input, amongst other native functionality. This pin is 3.3V tolerant only and 3.3V logic level.

### **GPIO12/SPI-SCLK**

This pin is shared with the micro-SD connector, and therefore typically must remain as a SCLK SPI pin. Used in conjunction with the GPIO38/SPI-CS pin, this can be fully utilised by the User as a SPI bus for external devices. If the micro-SD card is not required and not utilised, this pin can be utilised as a GPIO pin. It is native to the ESP32-S3 and can be utilised for Digital Input and Output, as well as Analog Input, amongst other native functionality. This pin is 3.3V tolerant only and 3.3V logic level.

### **GPIO13/SPI-MISO**

This pin is shared with the micro-SD connector, and therefore typically must remain as a MISO SPI pin. Used in conjunction with the GPIO38/SPI-CS pin, this can be fully utilised by the User as a SPI bus for external devices. If the micro-SD card is not required and not utilised, this pin can be utilised as a GPIO pin. It is native to the ESP32-S3 and can be utilised for Digital Input and Output, as well as Analog Input, amongst other native functionality. This pin is 3.3V tolerant only and 3.3V logic level.

### **GPIO20**

By default this pin is not available to the User, and is not hardware connected to the 30-way FFC connector. By default this pin is used by the native USB-C port (USB D+). This can however be configured to be connected to the 30-way FFC connector if the USB-C port is not required. When modified in hardware (refer to the [Hardware Mods section](#)), this pin is a General Purpose I/O pin native to the ESP32-S3. It is native to the ESP32-S3 and can be utilised for Digital Input and Output, as well as Analog Input, amongst other native functionality. This pin is 3.3V tolerant only and 3.3V logic level.

### **GPIO19**

By default this pin is not available to the User, and is not hardware connected to the 30-way FFC connector. By default this pin is used by the native USB-C port (USB D-). This can however be configured to be connected to the 30-way FFC connector if the USB-C port is not required. When modified in hardware (refer to the [Hardware Mods section](#)), this pin is a General Purpose I/O pin native to the ESP32-S3. It is native to the ESP32-S3 and can be utilised for Digital Input and Output, as well as Analog Input, amongst other native functionality. This pin is 3.3V tolerant only and 3.3V logic level.

### **GPIO0**

Available after boot, GPIO0 is used for Programming via UART and for Boot Strapping. It is a native ESP32-S3 GPIO pin, capable of Digital Input and Output only. It is 3.3V tolerant only and 3.3V logic level.

### **GPIO43**

GPIO43 is used typically as the primary UART, TX pin. If a UART is not required on this pin, then it can be used for GPIO instead. It is a native ESP32-S3 GPIO pin, capable of Digital Input and Output only. It is 3.3V tolerant only and 3.3V logic level.

### **GPIO44**

GPIO44 is used typically as the primary UART, RX pin. If a UART is not required on this pin, then it can be used for GPIO instead. It is a native ESP32-S3 GPIO pin, capable of Digital Input and Output only. It is 3.3V tolerant only and 3.3V logic level.

## 4.5. System Pins

### **5V IN (Module Voltage Input):**

Module supply voltage input pins. At least two (however ideally four) of these pins should be connected to a stable supply voltage in the range of 4.0 Volts to 5.5 Volts DC. Nominal operating voltage is 5.0 Volts. Utilising 4 pins shares the current over the FFC cable, which is important for the larger size displays.

### **GND (Module Ground):**

Device ground pins. At least two (ideally four) pins should be connected to the ground.

### **EN-RST (Module Enable/Disable/Reset):**

This pin is connected to a 10K pull-up resistor, which is pulling the module to the enabled state by default. Pulling this pin to 0V will disable the module, and put it into a reset state. Pulling the pin High or floating (due to build in pull-up resistor) will enable the module. This pin is utilised when utilising the UART Programming method.



---

## 4.6. Accessing Other GPIO Pins - Hardware Mods Required

### GPIO19

GPIO19 by default is USB-D-, part of the USB+/USB- combination for the Native USB-C port.

If there is no desire to utilise the on board USB-C connector, or an external extension is going to be made utilising the 30-way FFC connector, or the pins are desired to be GPIO, it is possible to achieve with a small hardware modification. In order to access this pin on the 30-way FFC, a resistor needs to be removed (R13) and another needs to be added (R8) or a simple solder blob will suffice in this position.

If this is going to be a required modification for your end-product and it will be used in a production application, it is possible to request 4D Systems to move this by default when you order the product. Please contact our Sales team with your requirements.

### GPIO20

GPIO20 by default is USB-D+, part of the USB+/USB- combination for the Native USB-C port.

If there is no desire to utilise the on board USB-C connector, or an external extension is going to be made utilising the 30-way FFC connector, or the pins are desired to be GPIO, it is possible to achieve with a small hardware modification. In order to access this pin on the 30-way FFC, a resistor needs to be removed (R12) and another needs to be added (R9) or a simple solder blob will suffice in this position.

If this is going to be a required modification for your end-product and it will be used in a production application, it is possible to request 4D Systems to move this by default when you order the product. Please contact our Sales team with your requirements.

### EXT-GPIO6

EXT-GPIO6 is one of the GPIO from the IO Expander, and by default is connected to the Touch Panels INT pin.

If there is no requirement for touch (ie you have a non-Touch module), or this pin is required and you plan on modifying the code/library to not utilise this pin, it can be redirected to the 30-way FFC by removing resistor R55, and adding it back into the position of R40 (or simply placing a solder blob).

If this is going to be a required modification for your end-product and it will be used in a production application, it is possible to request 4D Systems to move this by default when you order the product. Please contact our Sales team with your requirements.

## **EXT-GPIO7**

EXT-GPIO7 is one of the GPIO from the IO Expander, and by default is connected to the Touch Panels RESET pin.

If there is no requirement for touch (ie you have a non-Touch module), or this pin is required and you plan on modifying the code/library to not utilise this pin, it can be redirected to the 30-way FFC by removing resistor R56, and adding it back into the position of R41 (or simply placing a solder blob).

If this is going to be a required modification for your end-product and it will be used in a production application, it is possible to request 4D Systems to move this by default when you order the product. Please contact our Sales team with your requirements.

## 5. Module Features

The gen4-ESP32 Series is designed to accommodate a wide variety of applications. Some of the main features of the module are listed below.

### 5.1. ESP32-S3R8 Processor

The module is designed around the ESP32-S3R8 Processor from Espressif. This model of ESP32-S3 has 8MB of built in Octal SPI PSRAM, and utilises External Quad SPI Flash for application storage. Media is typically stored on a micro-SD card, however some types of media can be stored in SPI Flash, but it is very limited for capacity.

A majority of the ESP32-S3's GPIO pins are utilised for driving the RGB display, so this module features a Texas Instruments I2C IO Expander to provide 8 additional GPIO, 2 of which are used internally and the rest are available for the User.

### 5.2. Chipsets used

The gen4-ESP32 Series of modules utilises a few chipsets from various manufacturers, in order for these modules to operate. Please refer to the Schematic for connection details.

- The main processor is an Espressif ESP32-S3R8, as mentioned in the previous section.
- The backlight is controlled using a ETA Solutions ETA1611S2G backlight driver, which takes On/Off/PWM input from the ESP32-S3 using GPIO2.
- For Capacitive Touch models, the chipset for the capacitive touch is I2C driven, and the chipset is found on the Display flex itself. These utilise Focaltech FT5446 controllers for 4.3", 5.0" and 7.0" models.
- For Resistive Touch models, the chipset used is the NSIWAY NS2009 Resistive Touch driver, which is a 4-wire controller, and is I2C driven.
- The Real Time Clock utilises the NXP PCF8563T/5 real time clock, which is also I2C driven. This is battery backed up with a CR1220 coin cell battery.
- The IO Expander which provides 8 additional GPIO to the module, is the Texas Instruments TCA9554APWR controller, which is I2C driven.
- The Quad SPI Flash memory used on these modules, is the Giga-Devices GD25Q127C, which is 16MB in capacity, and interfaces to the ESP32-S3 on the same Octal/Quad SPI bus as the PSRAM which is built into the ESP32-S3R8 chipset itself.
- The micro-SD card interface, while not a chipset, is still worthy of note. It utilises a dedicated 1-bit SPI bus from the ESP32-S3, which can be shared with the User if required. The micro-SD cards used must be SPI compatible due to the interface type - more detail below.

### 5.3. SD/SDHC Memory Cards

The gen4-ESP32 modules use off-the-shelf standard SDHC/SD/microSD memory cards with up to 4GB capacity usable with FAT16 formatting, and much higher with FAT32 formatting. For any FAT file-related operations, before the memory card can be used it must first be formatted. The formatting of the card can be done on any PC system with a card reader.

Cards with a FAT16 formatting (4GB or under partition) are capable of operating faster on this display module, compared to the same card (16GB for example) with a single FAT32 partition, due to the nature of FAT16 vs FAT32 file transfers. If your application media can fit inside a 4GB partition, it is recommended to use FAT16 to gain the maximal speed possible.

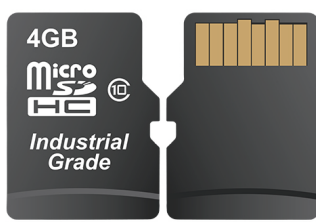

RMPET, a 4D Systems Tool found in the Workshop4 IDE, is capable of repartitioning and formatting microSD cards for FAT16, to be the appropriate type and format. This tool should be used for all cards as it also employs an offset which is critical when using Industrial microSD cards which feature Read Disturb Prevention firmware, which is a special firmware inside the microSD card designed to prevent Read Disturb occurring on NAND based Flash media. Further discussed in the note.

#### Note

1. An SPI Compatible SDHC/SD/microSD card MUST be used. The gen4-ESP32 modules requires SPI mode to communicate with the SD card. If a non-SPI compatible SD card is used, then the processor will not be able to mount the card.
2. Read disturbance is a well-known issue with flash memory devices, such as microSD cards, where reading data from a flash cell can cause the nearby cells in the same memory block to change over time. This issue can be prevented by using industrial-grade microSD cards with read disturb protection. Industrial-grade microSD cards have firmware that actively monitors the read operation and refreshes areas of memory that have high traffic and even move data around to prevent read disturb error from occurring. Furthermore, manufacturers may choose to implement read disturb protection on a specific part of the flash memory only, such that the beginning part of the memory might not be protected. The RMPET utility in Workshop4 is designed to create the first partition at an offset from the start of the microSD card to account for this situation. It is therefore recommended to always partition and format an industrial microSD card using the RMPET utility before using it with 4D Systems modules. Many commercial grade cards designed for Cameras etc, do not handle read disturb well at all, and therefore it is always recommended to use an Industrial grade microSD card with 4D modules. 4D offers one that is tried and tested, on our website.

## 5.4. microSD Socket Usage

On the gen4-ESP32 modules is a Latch-Type microSD socket. To use this socket is simple if you follow these easy steps.

- Unlock the empty socket by sliding/unlocking the socket towards the edge of the PCB (away from the battery holder).
- Lifting the lid of the socket, and hinging it up off the PCB, towards the edge of the module.
- Placing a microSD card into the socket.
- Lowering the lid of the socket back down, by hinging it down towards the PCB again.
- Locking the socket back in place by sliding/locking the socket towards the battery holder.

Please refer to the following diagram for guidance:

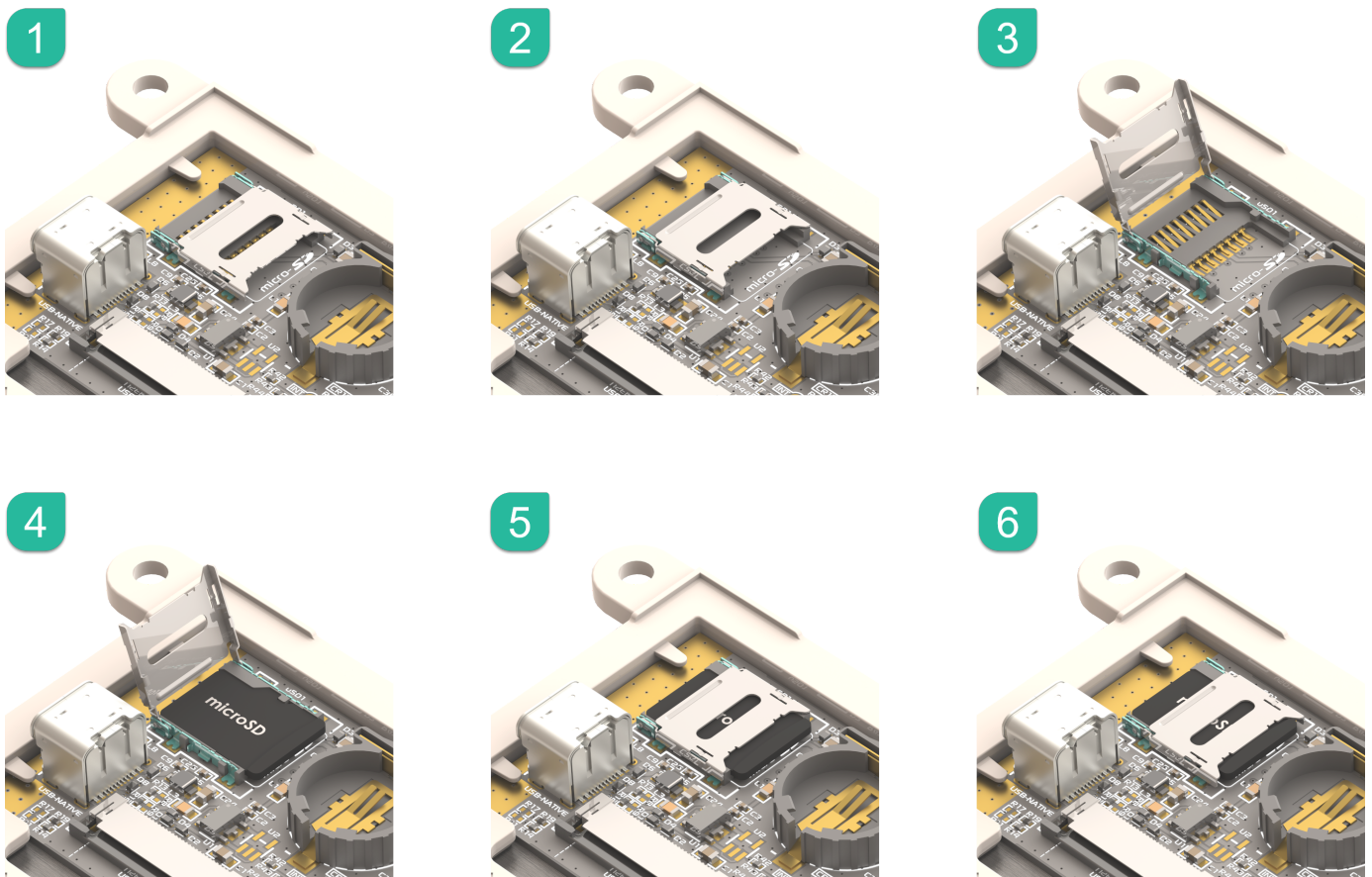

## 5.5. FAT16 vs FAT32

FAT16 is capable of having a partition with up to 4GB capacity usable. While this might seem like a limitation, it still offers the best performance for small processor systems such as the ESP32-S3. Larger partitions are possible with FAT32 formatting, however smaller cluster size results, giving slightly worse performance.

For any FAT file-related operations, before the memory card can be used it must first be formatted correctly. Built into Workshop4 is a tool created by 4D, called RMPET (please refer to the Tools menu, in any Environment, inside the Workshop4 IDE). RMPET allows the User to easily partition and format microSD cards, to make their file system ready to be used with 4D Systems modules. The formatting of the card can be done on any Windows PC system with a card reader.

## 5.6. Wide Viewing Angle (WVA)

The 7.0" model in this gen4 series has the option to use a WVA-type display, rather than the standard TN display. While WVA is physically still a TN display, it features much wider viewing angles and prevents image inversion when viewing at steep viewing angles. The outcome is a similar effect and visual improvement to an IPS display, while still using a cost-effective TN display technology. Many applications can benefit from wider viewing angles.

---

## 6. Display/Module Precautions

- Avoid having to display the same image/object on the screen for lengthy periods. This can cause a burn-in which is a common problem with all types of display technologies. Blank the screen after a while or dim it very low by adjusting the contrast. Better still; implement a screen saver feature.
- Moisture and water can damage the display. Moisture on the surface of a powered display should not cause any problems, however, if water is to enter the display either from the front or from the rear, or come in contact with the PCB, it will damage. Wipe off any moisture gently or let the display dry before usage. If using this display module in an environment where it can get wet, ensure an appropriate enclosure is used.
- Dirt from fingerprint oil and fat can easily stain the surface of the display. Gently wipe off any stains with a soft lint-free cloth.
- The performance of the display will degrade under high temperatures and humidity. Avoid such conditions when storing.
- Do not tamper with the display flex cable that is connected to the control board. This may affect the connection between the display and the driving circuitry and cause failure.
- Displays are susceptible to mechanical shock and any force exerted on the module may result in deformed zebra stripes, a cracked display cell and a broken backlight.
- Always use the mounting holes on the module's to mount the display where possible, or mount using the CLB for CLB based modules.
- Display modules have a finite life, which is typically dictated by the display itself, more specifically the backlight. The backlight contains LEDs, which fade over time. In the [Specifications section](#) is a figure for the typical life of the display, and the criteria are listed.
- The resistive Touch model features a touch-sensitive film over the display which is sensitive to pressure. When mounting the display module in an enclosure, you should not apply pressure to the surface of the display by the enclosure. It could result in false touches or the touch will simply not function at all.

## 7. Hardware Tools

The following hardware tools are required for full control of the gen4-ESP32 Display Modules.

### 7.1. 4D-UPA

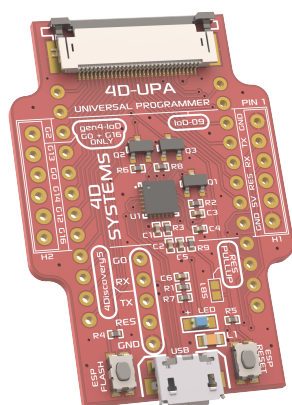

4D-UPA Front

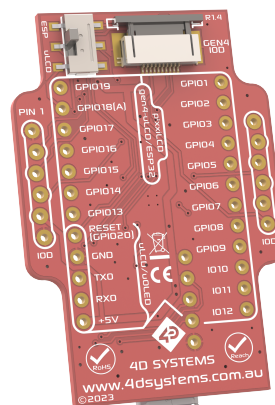

4D-UPA Back

The 4D-UPA minimizes the connections and modules required for programming the gen4-ESP32 series via its UART - creating a single module with a micro USB interface, and DIP style pads for GPIO breakout of all the signals used on the gen4 Display interface, which is useful for development or final product use.

The GPIO naming convention on the 4D-UPA does not reflect the GPIO naming of the actual display module, due to the 4D-UPA being universal and able to be used with many 4D Products. Please review the 4D-UPA datasheet for information on mapping the GPIO naming from this module, with the GPIO naming on the 4D-UPA, to ensure you connect to the correct pins you desire.

Typically a 4D-UPA should not be required for programming the gen4-ESP32 series of modules, as they have USB-C on board, however if problems occur or situations arise that the USB-C is non functional, then the 4D-UPA would be required, so it is a good tool to have on hand.



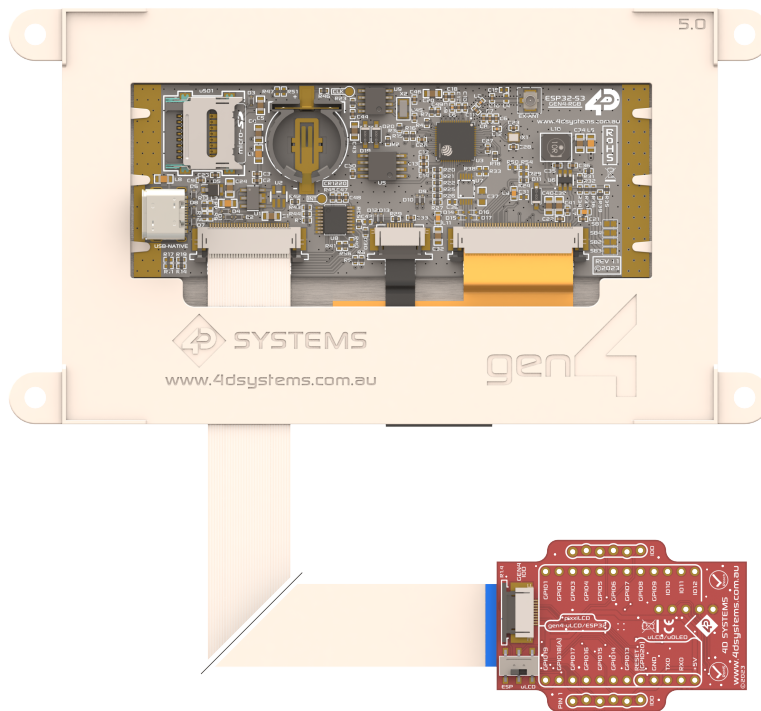

The 4D-UPA is connected to the ESP32 module using the supplied 30-way FFC Cable. The connectors on both the ESP32 module, and the 4D-UPA, are Top-Contact, meaning the FFC cable pins should be facing upwards, and the blue stiffener, should be facing down towards the PCB.

 **Note**

1. 4D-UPA REV 1.4 and higher is required to program a ESP32 processor. Anything < REV 1.4 will not work for programming ESP32 based products. Please be sure to refer to the 4D-UPA Datasheet.
2. If using the 4D-UPA, only the supplied FFC cable (or same type) can be used. The type of cable supplied, as described in the **FFC Cable** section, is an Opposite type (contacts on opposite sides to each other at end end). If a straight cable (contacts on the same side at both ends) is sourced, this will NOT work when connecting to the 4D-UPA, as the connections will be swapped. Please refer to the information provided for more detail.

## 7.2. USB-C Cable

A USB-C Cable is the primary way to program a gen4-ESP32 module from 4D Systems, aside from using a 4D-UPA, as described previously.

A USB-C cable is not supplied with the modules, as they can be sourced from any computer or hardware store, and come with most Cell Phones these days too.

Connection of the USB-C cable to the module is simple, and simply plugs into the USB-C connector on the board, clearing the gen4 plastics on the side.

The USB-C provides power as well as USB Data communications, for while developing software on the module and programming it. The USB-C cable can be used in the end product use if desired, or the use of the FFC-Cable directly to the projects main Application PCB as an alternative.

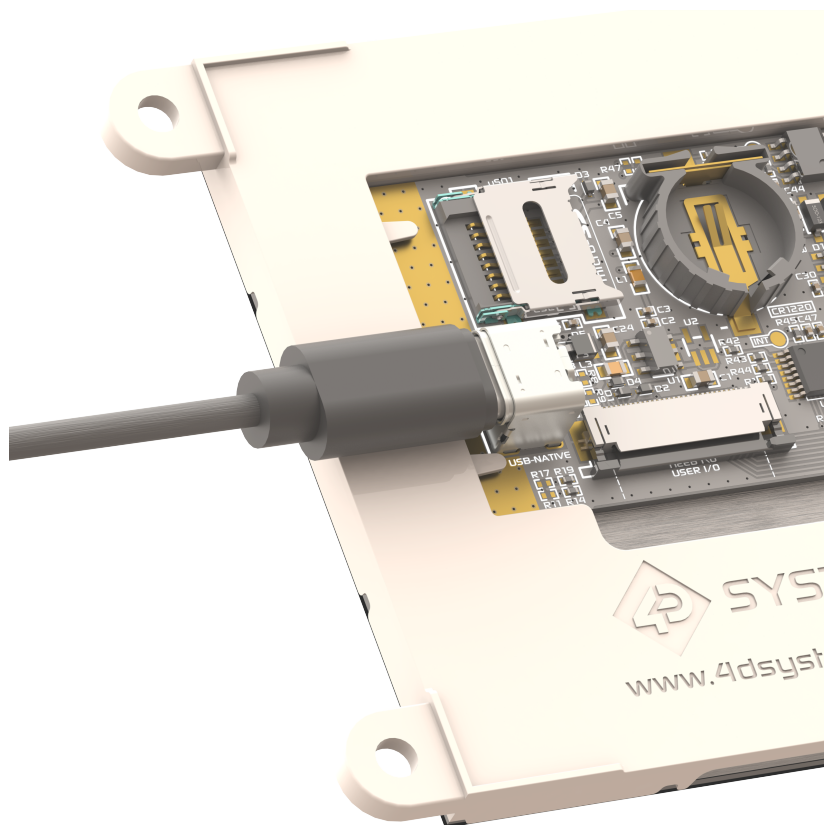

*USB-C Connection*

## 8. Workshop4 IDE

Workshop4 is a comprehensive software IDE that provides an integrated software development platform for all of the 4D family of processors and modules, as well as some 3rd party processors such as the Espressif ESP32.

The IDE provides an Editor and WYSIWYG design area for gen4-ESP32 based modules, to develop complete application code with various widgets and media references as required. All user application code is developed within the Workshop4 IDE, and is easily coupled with graphics and media, so is a one stop shop for development with these modules.

The Workshop4 IDE utilises the Arduino IDE 2.x CLI to handle the compiling, linking and downloading of ESP32 based projects, using the ESP32 Arduino Core and associated libraries, without having to interface with the Arduino IDE at all.

### Note

Arduino IDE 2.x and Arduino CLI is not included when installing Workshop4 and must be installed separately.

For complete development setup instructions, please refer to the [Workshop4 ESP32 Development Manual](#)

### 8.1. Tools available inside the Workshop IDE

Built into Workshop4 are a number of tools which are available to aid the programming of the gen4-ESP32 series of displays.

**Terminal**, as the name implies, is a terminal application that can be used to communicate with the display module and is primarily used for basic debugging. It displays incoming Serial messages from the display module in ASCII and HEX format. It is capable of sending character or hex strings as well as keystrokes to the display.

**RMPET** is a partitioning and formatting tool, used to correctly set up a micro-SD card for use with 4D Systems products. This is further discussed in the [SD/SDHC Memory Cards section](#)

## 9. Programming Language

The programming language used in the Workshop4 IDE to program the gen4-ESP32 series of modules, is C++, which is the same as native Arduino IDE written code.

The Arduino programming language is a user-friendly coding system tailored for Arduino microcontrollers. It simplifies microcontroller coding, bridging the gap between users and hardware. Its approachability and community support make it ideal for various projects.

## 10. Display Module Part Numbers

The following is a breakdown of the part numbers and what they mean.

### Examples:

- gen4-ESP32-43T
- gen4-ESP32-50CT
- gen4-ESP32-70CT-CLB-WVA

### Example Starter Kits

- SK-gen4-ESP32-43T
- SK-gen4-ESP32-50CT
- SK-gen4-ESP32-70CT-CLB-WVA

where:

```
SK - Starter Kit (kitting of multiple parts)
gen4 - gen4 Display Range
ESP32 - ESP32 Display Family
43 - Display size (4.3")
50 - Display size (5.0")
70 - Display size (7.0")
T - Resistive Touch
CT - Capacitive Touch
CLB - Cover Lens Bezel
WVA - Wide Viewing Angle display (7.0" only)
```

### Note

- The SK at the start denotes it's a Starter Kit, and the rest of the part number describes the display module in the Starter Kit.
- A product without a T or CT in the part number is a non-touch variant.
- Cover Lens Bezels (CLB) are glass fronts for the display module with overhanging edges, which allow the display module to be mounted directly into a panel using special adhesive on the overhanging glass. This is available for capacitive touch only.
- Resistive Touch models are not available in CLB, as a CLB is made of glass and resistive touch relies on the mechanical flexing of a membrane to trigger touch.
- WVA stands for Wide Viewing Angle and is a special and optional addition to the 7" range of modules, which boosts viewing angles of the display and prevents image inversion when viewing at steep viewing angles. The outcome is a similar effect and visual improvement to an IPS display, however, it uses a TN display. This is only an option for the 7". WVA models are the same physical dimensions as a regular 7".

## 11. Cover Lens Bezel - Tape Spec

The perimeter of the CLB display modules features double-sided adhesive tape, designed to stick directly onto a panel, enclosure, box etc without the need for any mounting screws or hardware.

The tape used is 3M 9495LE tape, which uses well-known and strong 3M 300LSE adhesives. The double-sided adhesive has a thickness of 0.175mm once the backing has been removed.

More information on this adhesive can be found on the 3M website.

## 12. FFC Cable

The FFC cables supplied by 4D Systems (included with products) have the following specifications:

- **30 Pin** Flexible Flat Cable, 150mm Long, 0.5mm (0.02") pitch
- Cable Type: AWM 20624 80C 60V VW-1
- Heat Resistance 80 Degrees Celsius
- Connections on the opposite side at each end (Type B)

You can get different cable lengths from the 4D Systems website.

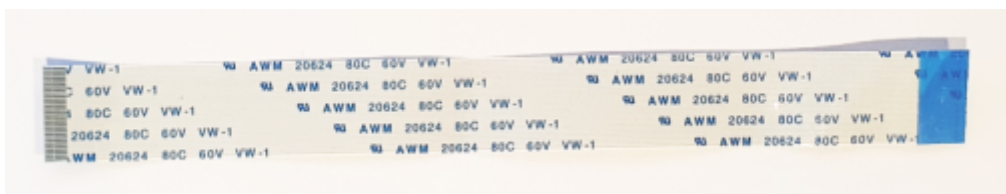

### Note

If you are interfacing with this module directly to your product via the 30-way FFC rather than utilising a breakout board or 4D-UPA, suitable connectors are readily available from many electronics suppliers, such as Digikey, Mouser, Farnell, RS, etc.

A standard 30-pin, 0.5mm pitch, 0.3mm thick FFC, FFC connector. They are available in Top Contact and Bottom Contact, so depending how you orientate the cable on your product, will determine which one you need. Please however take care of the pinout and how it flows from the display module, through the FFC and into your product, to ensure Pin1 and Pin30 are where you expect them to be.

The ESP32 modules are designed with gen4 plastics and the FFC cable can either be connected and sit above the plastics, or can thread underneath and out the bottom.

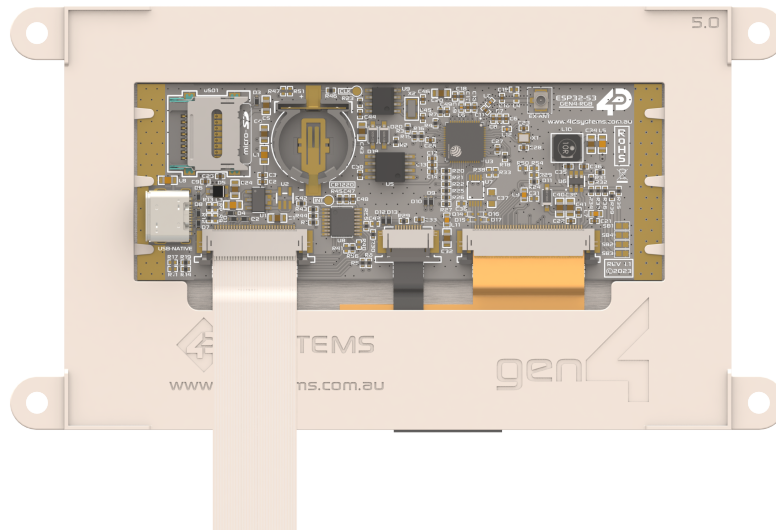

*FFC Cable - Over Plastics*

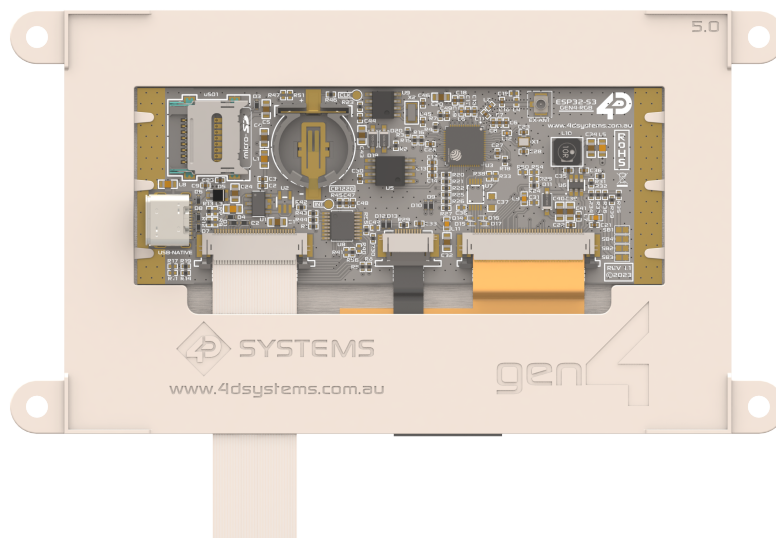

*FFC Cable - Under Plastics*

---

## 13. Starter Kit

4D Systems highly recommends all first-time buyers of 4D Systems' displays, to purchase the Starter Kit when purchasing their first 4D Systems display solution.

The Starter Kit provides all the hardware that is required to get the User up and running.

### **Starter Kits typically include:**

- gen4 ESP32 Display Module
- gen4 Breakout Board (gen4-Breakout)
- 4D Universal Programming Adaptor (4D-UPA REV1.4 or higher)
- 4GB micro-SD Card
- 150mm 30-way FFC cable for connecting display to gen4-Breakout, 4D-UPA, or Users System
- WiFi Antenna (u.FL to SMA, and screw on SMA antenna)

Please refer to the [4D Systems website](#) for the current components included in the Starter Kit.

Simply select the Starter Kit option when purchasing the chosen display module on the 4D Systems shopping cart, or from your local distributor.

# 14. 4.3" Mechanical Details (Non-Touch, Resistive Touch, Capacitive Touch)

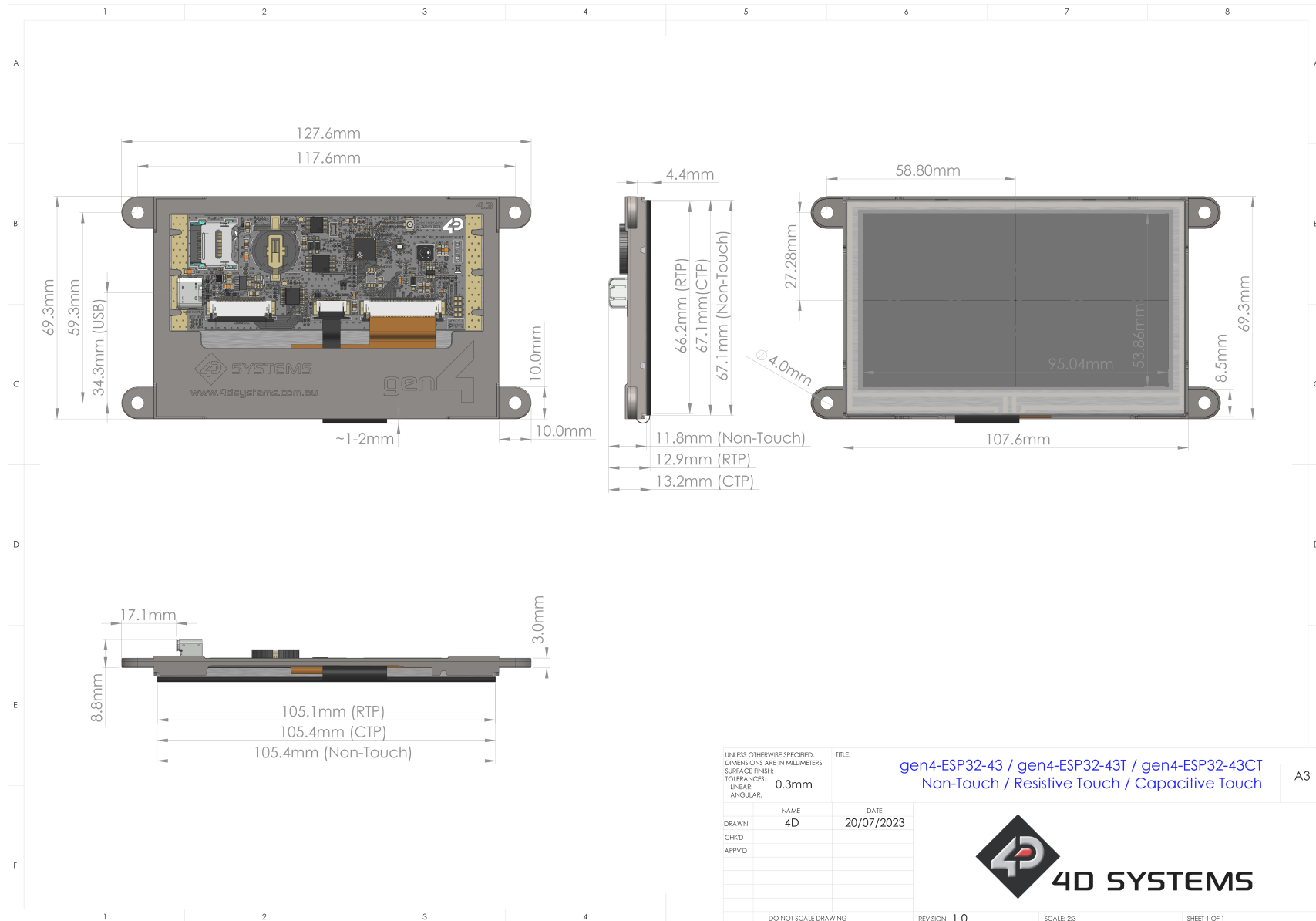



# 15. 4.3" Mechanical Details (Capacitive Touch with CLB)

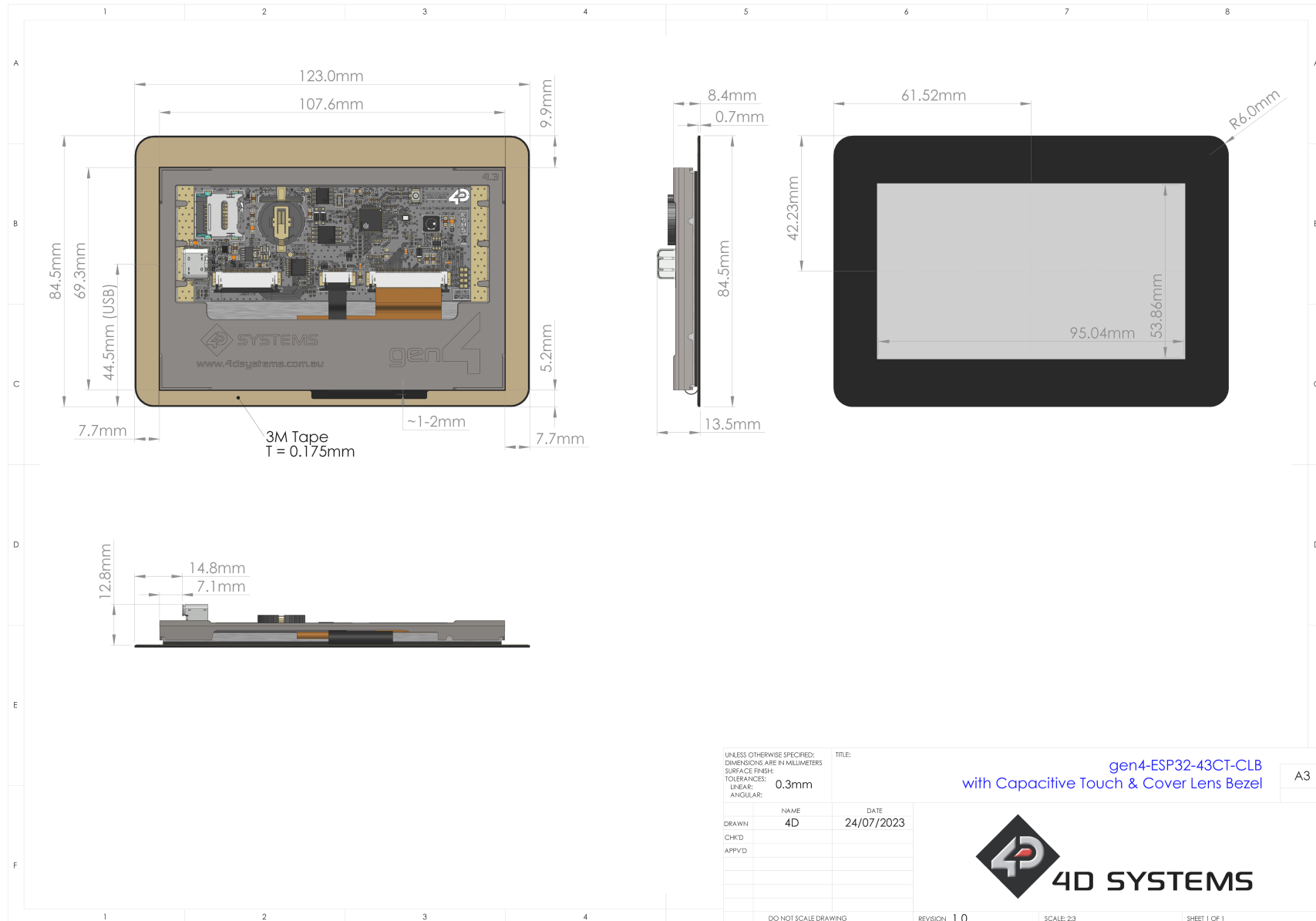

UNLESS OTHERWISE SPECIFIED: DIMENSIONS ARE IN MILLIMETERS SURFACE FINISH: TOLERANCES: LINEAR: 0.3mm ANGULAR:		TITLE:  gen4-ESP32-43CT-CLB with Capacitive Touch & Cover Lens Bezel	A3
DRAWN: CHK'D: APP'VD:	NAME: 4D	DATE: 24/07/2023	
DO NOT SCALE DRAWING		REVISION 1.0	SCALE: 2:3
			SHEET 1 OF 1

# 16. 5.0" Mechanical Details (Non-Touch, Resistive Touch, Capacitive Touch)

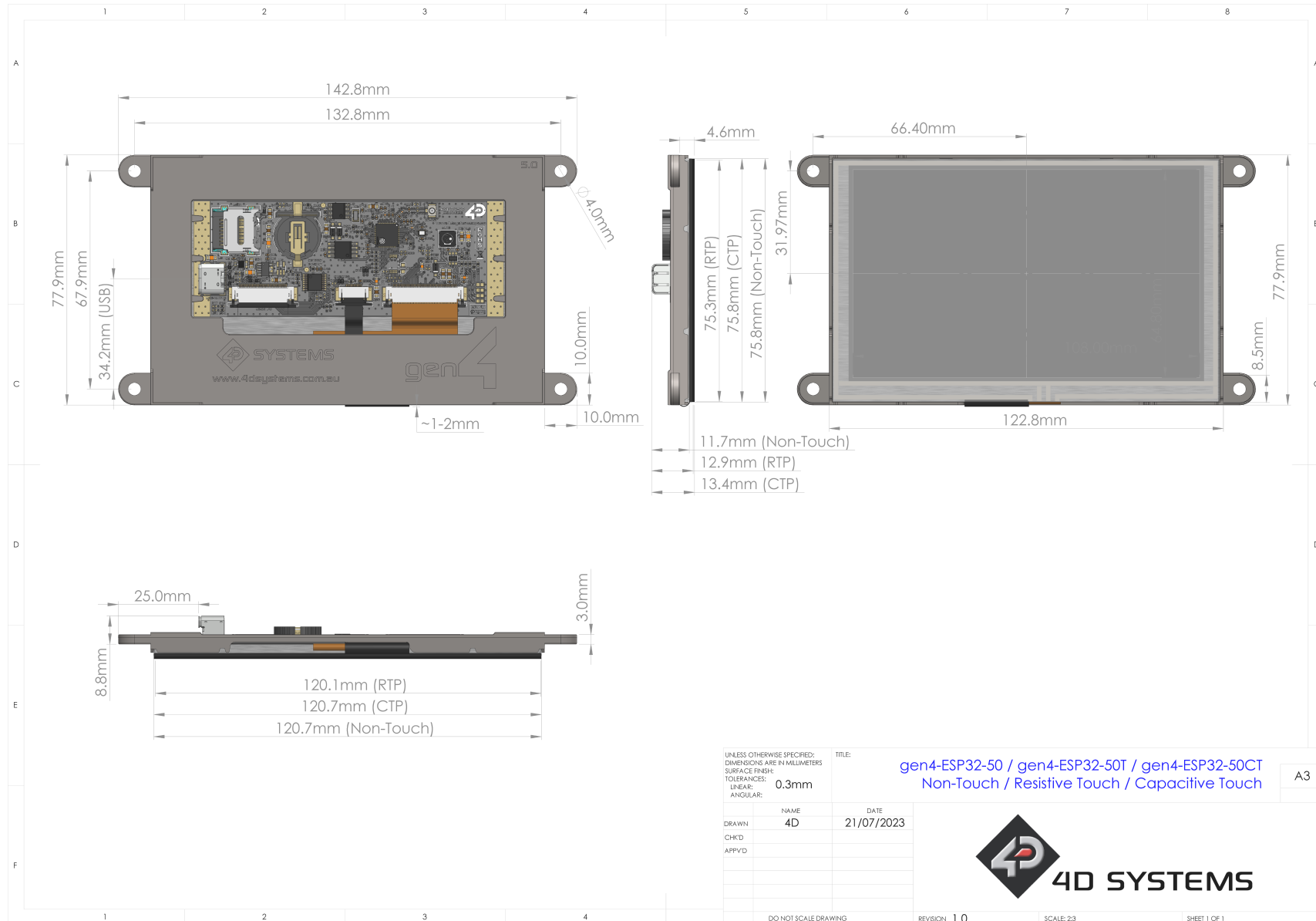

# 17. 5.0" Mechanical Details (Capacitive Touch with CLB)

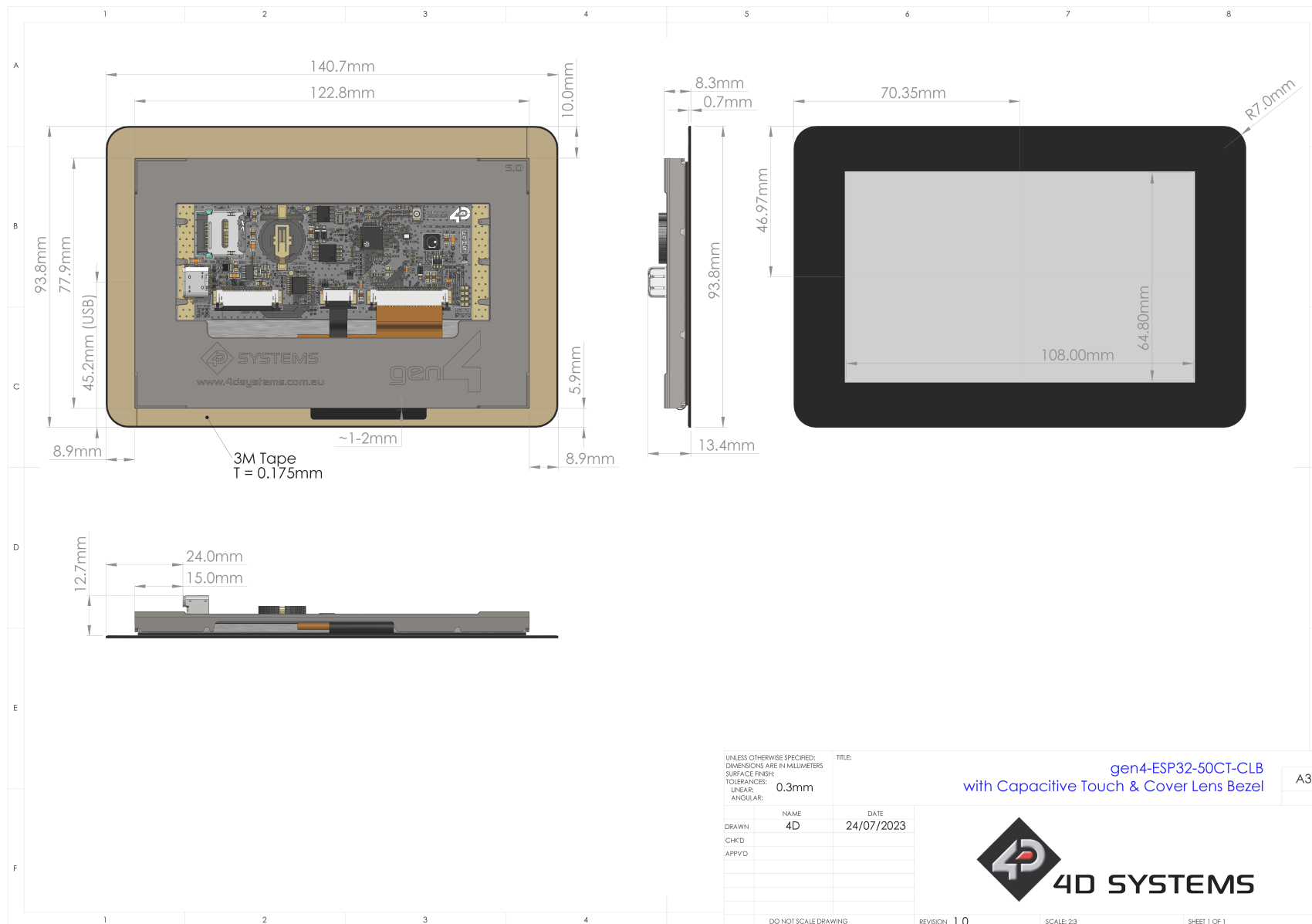

# 18. 7.0" Mechanical Details (Non-Touch, Resistive Touch, Capacitive Touch)

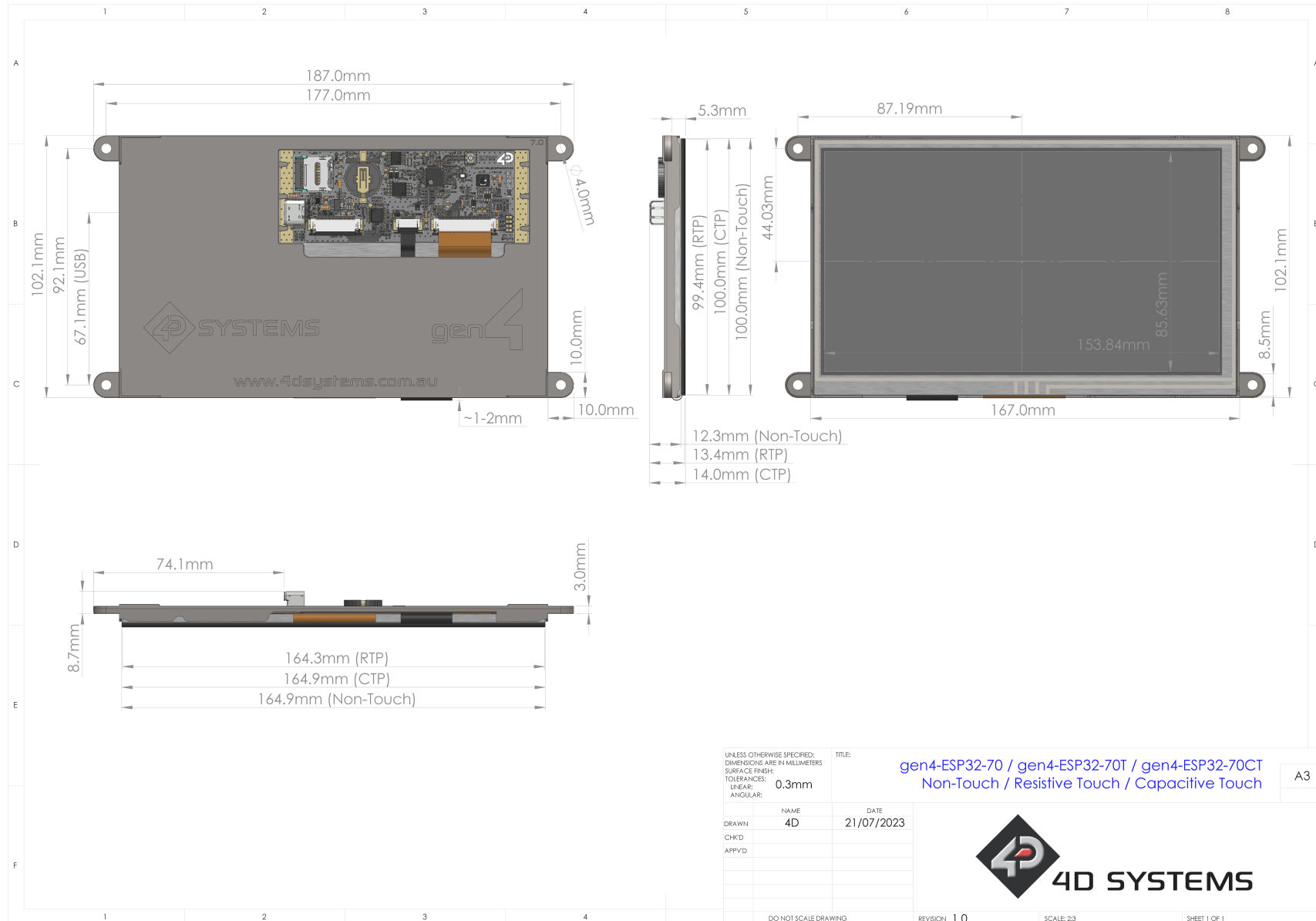

# 19. 7.0" Mechanical Details (Capacitive Touch with CLB)

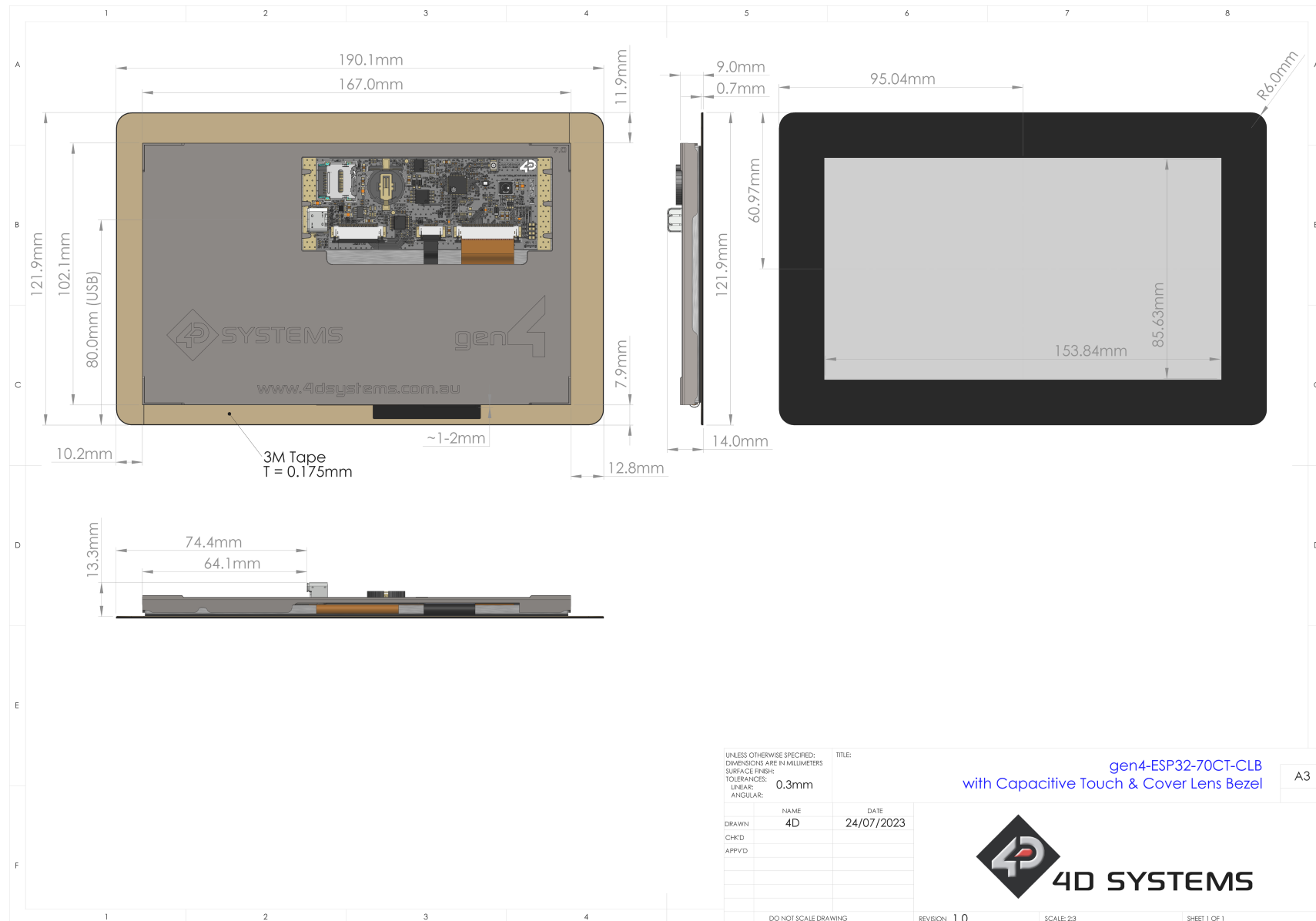

UNLESS OTHERWISE SPECIFIED: DIMENSIONS ARE IN MILLIMETERS SURFACE FINISH: TOLERANCES: LINEAR: 0.3mm ANGULAR:		TITLE: <b>gen4-ESP32-70CT-CLB with Capacitive Touch &amp; Cover Lens Bezel</b>	A3
DRAWN: CHK'D: APP'VD:	NAME: <b>4D</b>	DATE: <b>24/07/2023</b>	
DO NOT SCALE DRAWING		REVISION: 1.0	SCALE: 2:3
			SHEET 1 OF 1

# 20. Schematic Circuit Details

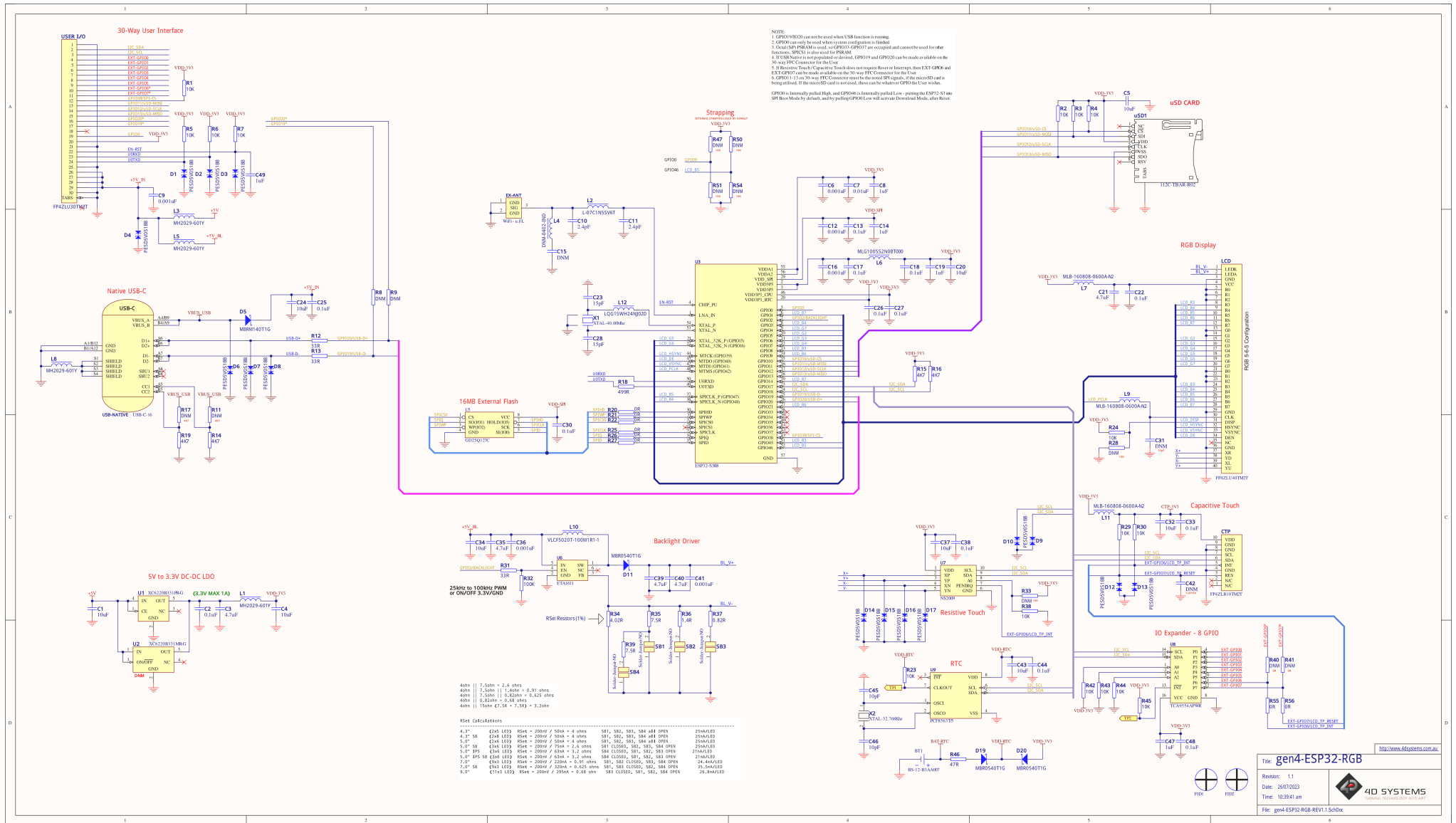

## 21. Specifications

### Absolute Maximum Ratings

Operating ambient temperature	-20°C to +65°C (see note 1 and 2)
Storage temperature	-30°C to +80°C
Voltage on any digital input pin (ESP32) with respect to GND	-0.3V to 3.6V
Voltage on any digital input pin (IO Expander) with respect to GND	-0.3V to 6.0V
Voltage on VCC with respect to GND	-0.3V to 6.5V

### Note

#### 1. Quote Espressif

"Ambient temperature specifies the recommended temperature range of the environment immediately outside an Espressif chip. For ESP32-S3R8 if the PSRAM ECC function is enabled, the maximum ambient temperature can be improved to 85°C, while the usable size of PSRAM will be reduced by 1/16"

#### 2. Temperature range for Ambient and Storage, are determined by a combination of components used on these modules. While some components may be capable of exceeding these temperatures, some are not, so the minimums/maximums are determined by the weakest device on the modules. Based on the 65°C/85°C note above, if the ESP32-S3R8 is increased to 85°C capability, the next 'weakest' component on the module is the TFT LCD, which is capable of -20°C to 70°C Operating Temp.

#### 3. Stresses above those listed here may cause permanent damage to the device. This is for stress rating only and functional operation of the device at those or any other conditions above those indicated in the recommended operation listings of this specification is not implied. Exposure to maximum rating conditions for extended periods may affect device reliability.

### Recommended Operating Conditions

Parameter	Conditions	Min	Typ	Max	Units
Supply Voltage (VCC)	Stable external supply required	4.0	5.0	6.0	V
Processor voltage (VP)		--	3.3	--	V
Input Low Voltage (VIL)	all pins	0	--	0.25VP	V
Input High Voltage (VIH)	non 5V tolerant pins	0.75VP	--	VP+0.3	V
Input High Voltage (VIH)	5V tolerant pins	0.8VP	--	5.5	V

**Global Characteristics Based on Operating Conditions**

Parameter	Conditions	Min	Typ	Max	Units
Supply Current (ICC) ***	gen4-ESP32-43 (Contrast = 15)	--	208	--	mA
	gen4-ESP32-43T (Contrast = 15)	--	210	--	mA
	gen4-ESP32-43CT (Contrast = 15)	--	216	--	mA
	gen4-ESP32-43CT-CLB (Contrast = 15)	--	216	--	mA
	gen4-ESP32-50 (Contrast = 15)	--	318	--	mA
	gen4-ESP32-50T (Contrast = 15)	--	320	--	mA
	gen4-ESP32-50CT (Contrast = 15)	--	326	--	mA
	gen4-ESP32-50CT-CLB (Contrast = 15)	--	326	--	mA
	gen4-ESP32-70 (Contrast = 15)	--	598	--	mA
	gen4-ESP32-70T (Contrast = 15)	--	600	--	mA
	gen4-ESP32-70CT (Contrast = 15)	--	607	--	mA
	gen4-ESP32-70CT-CLB (Contrast = 15)	--	607	--	mA
	gen4-ESP32-70-WVA (Contrast = 15)	--	598	--	mA
	gen4-ESP32-70T-WVA (Contrast = 15)	--	600	--	mA
	gen4-ESP32-70CT-WVA (Contrast = 15)	--	607	--	mA
gen4-ESP32-70CT-CLB-WVA (Contrast = 15)	--	607	--	mA	
Display Endurance	Hours of operation, measured to when display is 50% original brightness	30000	--	--	H
Touch Screen Endurance (Resistive Touch)	Number of touches/hits with a 12.5mm tip at a rate of 2x per second with 250gf force	--	1M	--	Touches
	Slide stylus on screen, 100gf force, 60mm/s speed with a 0.8mm polyacetal tip stylus pen	--	100K	--	Slides
Touch Screen Transparency	Resistive Touch	82	--	--	%
	Capacitive Touch	90	--	--	%
Touch Screen Operational Force (Resistive Touch)	Only use Finger or Stylus, do not use anything sharp or metal	20	--	100	Gf
CLB Hardness	Cover Lens Bezel Glass Hardness	--	6	--	H

**Note**

Typical Supply Current (ICC) figures are without WiFi enabled, without microSD card inserted, and using simple display operations only. Any additional load such as GPIO sourcing, WiFi etc, will increase this figure. This is a typical figure only, not a Maximum.



 **LCD DISPLAY INFORMATION (TN DISPLAY)**

Parameter	Conditions	Specification
Display Type		TN - TFT Transmissive LCD
Display Size		7.0" Diagonal
Display Resolution		800 x 480 (Landscape/Wide Viewing)
Display Brightness	gen4-ESP32-70 (Contrast = 15)	500 cd/m2
	gen4-ESP32-70T (Contrast = 15)	400 cd/m2
	gen4-ESP32-70CT (Contrast = 15)	475 cd/m2
	gen4-ESP32-70CT-CLB (Contrast = 15)	475 cd/m2
	gen4-ESP32-70-WVA (Contrast = 15)	470 cd/m2
	gen4-ESP32-70T-WVA (Contrast = 15)	376 cd/m2
	gen4-ESP32-70CT-WVA (Contrast = 15)	446 cd/m2
	gen4-ESP32-70CT-CLB-WVA (Contrast = 15)	446 cd/m2
	Display Contrast Ratio	Typical
Display Viewing Angles	Above Centre (non WVA models)	70 Degrees
	Below Centre (non WVA models)	60 Degrees
	Left of Centre (non WVA models)	70 Degrees
	Right of Centre (non WVA models)	70 Degrees
	Above Centre (WVA only)	85 Degrees
	Below Centre (WVA only)	80 Degrees
	Left of Centre (WVA only)	85 Degrees
	Right of Centre (WVA only)	85 Degrees
Display Viewing Direction		12 O'clock Display (Optimal viewing is from above when in Landscape/Wide mode)
Display Backlighting	All 7.0" models	9x3 Parallel LED's
Pixel Pitch	Width x Height – Landscape	0.1925 x 0.179 mm (non-Square pixels)
Pixel Density	Number of pixels in 1 row in 25.4mm, 7.0"	132 DPI/PPI (Horizontal)
		142 DPI/PPI (Vertical)

 **LCD DISPLAY INFORMATION (IPS DISPLAY)**

Parameter	Conditions	Specification
Display Type		IPS - TFT Transmissive LCD
Display Size	4.3" Models	4.3" Diagonal
	5.0" Models	5.0" Diagonal
Display Resolution		800 x 480 (Landscape/Wide Viewing)
Display Brightness	gen4-ESP32-43 (Contrast = 15)	600 cd/m2
	gen4-ESP32-43T (Contrast = 15)	510 cd/m2
	gen4-ESP32-43CT (Contrast = 15)	540 cd/m2
	gen4-ESP32-43CT-CLB (Contrast = 15)	540 cd/m2
	gen4-ESP32-50 (Contrast = 15)	600 cd/m2
	gen4-ESP32-50T (Contrast = 15)	510 cd/m2
	gen4-ESP32-50CT (Contrast = 15)	540 cd/m2
	gen4-ESP32-50CT-CLB (Contrast = 15)	540 cd/m2
Display Contrast Ratio	Typical (4.3")	800:1
	Typical (5.0")	1000:1
Display Viewing Angles	Above Centre	80 Degrees
	Below Centre	80 Degrees
	Left of Centre	80 Degrees
	Right of Centre	80 Degrees
Display Viewing Direction		ALL (wide viewing IPS Display)
Display Backlighting	4.3" Models	2x5 Parallel LED's
	5.0" Models	3x6 Parallel LED's
Pixel Pitch	4.3" Models	0.1188 x 0.1122 mm (Almost Square pixels)
	5.0" Models	0.135 x 0.135 mm (Square pixels)
Pixel Density	4.3" Number of pixels in 1 row in 25.4mm	213 DPI/PPI (Horizontal) 226 DPI/PPI (Vertical)
	5.0" Number of pixels in 1 row in 25.4mm	183 DPI/PPI

 **Note**

Relevant for all TN and IPS displays, the Displays used are of the highest rated 'Grade A', which allows for 0-4 defective pixels. A defective pixel could be solid Black (Dead), White, Red, Green or Blue.

## 22. Revision History



### Datasheet Revision

Revision Number	Date	Description
0.1	09/05/2023	Internal Use Only
1.0	12/09/2023	Initial Public Release Version



### Hardware Revision

Revision Number	Date	Description
1.0	20/04/2023	Initial Internal Version
1.1	30/06/2023	Initial Public Release Version

---

## 23. Legal Notice

### 23.1. Proprietary Information

The information contained in this document is the property of 4D Systems Pty. Ltd. and may be the subject of patents pending or granted, and must not be copied or disclosed without prior written permission. 4D Systems endeavours to ensure that the information in this document is correct and fairly stated but does not accept liability for any error or omission. The development of 4D Systems products and services is continuous and published information may not be up to date. It is important to check the current position with 4D Systems. 4D Systems reserves the right to modify, update or makes changes to Specifications or written material without prior notice at any time.

All trademarks belong to their respective owners and are recognised and acknowledged.

### 23.2. Disclaimer of Warranties & Limitations of Liabilities

4D Systems makes no warranty, either expressed or implied with respect to any product, and specifically disclaims all other warranties, including, without limitation, warranties for merchantability, non-infringement and fitness for any particular purpose.

Information contained in this publication regarding device applications and the like is provided only for your convenience and may be superseded by updates. It is your responsibility to ensure that your application meets with your specifications.

Images and graphics used throughout this document are for illustrative purposes only. All images and graphics used are possible to be displayed on the 4D Systems range of products, however the quality may vary.

In no event shall 4D Systems be liable to the buyer or to any third party for any indirect, incidental, special, consequential, punitive or exemplary damages (including without limitation lost profits, lost savings, or loss of business opportunity) arising out of or relating to any product or service provided or to be provided by 4D Systems, or the use or inability to use the same, even if 4D Systems has been advised of the possibility of such damages.

4D Systems products are not fault tolerant nor designed, manufactured or intended for use or resale as on line control equipment in hazardous environments requiring fail - safe performance, such as in the operation of nuclear facilities, aircraft navigation or communication systems, air traffic control, direct life support machines or weapons systems in which the failure of the product could lead directly to death, personal injury or severe physical or environmental damage ('High Risk Activities'). 4D Systems and its suppliers specifically disclaim any expressed or implied warranty of fitness for High Risk Activities.

Use of 4D Systems' products and devices in 'High Risk Activities' and in any other application is entirely at the buyer's risk, and the buyer agrees to defend, indemnify and hold harmless 4D Systems from any and all damages, claims, suits, or expenses resulting from such use. No licenses are conveyed, implicitly or otherwise, under any 4D Systems intellectual property rights.

## X-ON Electronics

Largest Supplier of Electrical and Electronic Components

*Click to view similar products for [Display Development Tools](#) category:*

*Click to view products by [4D Systems](#) manufacturer:*

Other Similar products are found below :

[TW8819-NA2-CR-EVAL](#) [LCD-16396](#) [KIT-19297](#) [EA 9781-2USB](#) [7inch HDMI LCD \(C\)](#) [1.28inch LCD Module](#) [1.54inch e-Paper](#) [1.02inch e-Paper](#) [LPU4CG031B](#) [MCIMX-LVDS1](#) [MIKROE-2453](#) [BREAK OUT BOARD 20](#) [BREAK OUT BOARD 36](#) [131](#) [LCD8000-43T](#) [DEV-13628](#) [1590](#) [MIKROE-2269](#) [1673](#) [1770](#) [1947](#) [1987](#) [KIT 60125-3](#) [KIT 67110-3](#) [2050](#) [2218](#) [2219](#) [2260](#) [2345](#) [2423](#) [2454](#) [2478](#) [2674](#) [SK-220RD-PI](#) [1811](#) [627](#) [SK-GEN4-50DCT-CLB-SB-AR](#) [MIKROE-2789](#) [3130](#) [MIKROE-2659](#) [3163](#) [FIT0477](#) [P0075](#) [333](#) [3330](#) [1774](#)  
[DFR0486](#) [334](#) [NHD-TFT40](#) [DFR0260](#)