

Accessories Multimode Relay MT

- Snap-on mounting on DIN-rail
- Screw mounting
- Pozidrive screws with rising clamp terminals
- Logical layout of input-/output connections
- White marking area

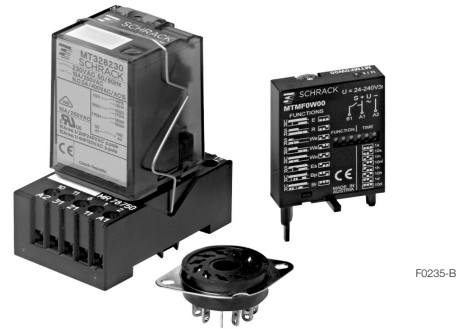

MT DIN-rail sockets with screw-type terminals

- MT 78 750** MT3 DIN-rail socket with screw-type terminals, 11-pin
- MT 78 755** MT2 DIN-rail socket with screw-type terminals, 8-pin

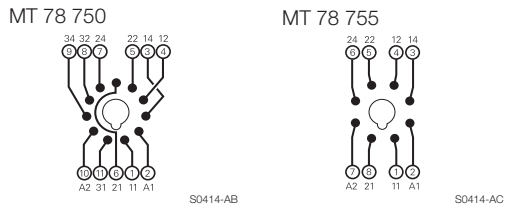
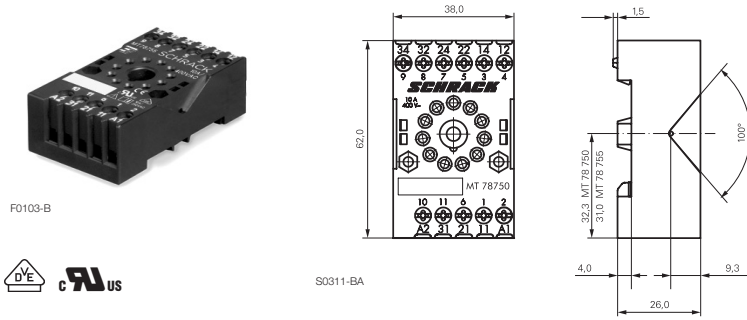

- MT78 760** MT3 DIN-rail socket with screw-type terminals, 11-pin

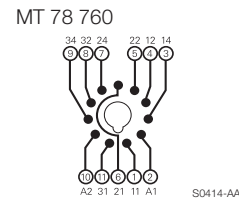
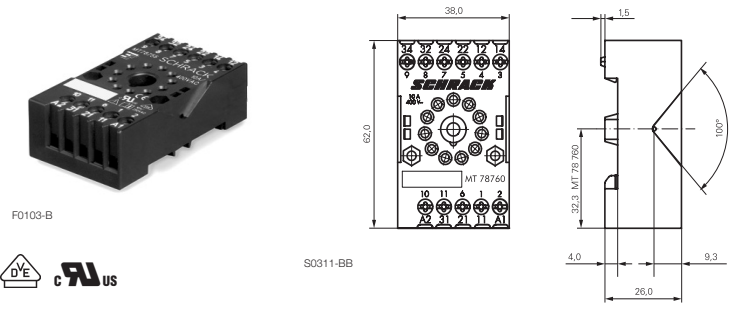

- MT 78 740** MT3 DIN-rail socket with screw-type terminals, 11-pin
- MT 78 745** MT2 DIN-rail socket with screw-type terminals, 8-pin

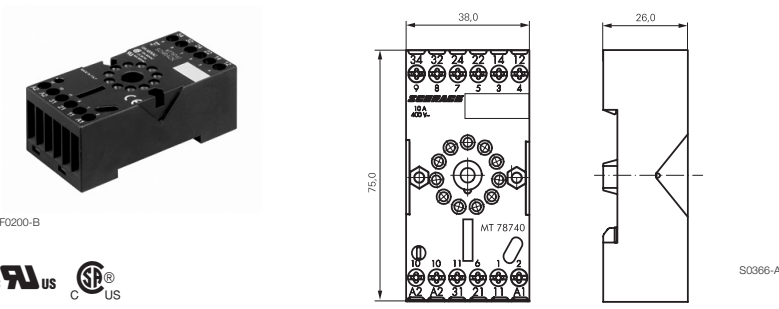

- Socket system MT 78 740 and MT 78 745
- 8/11 pin socket for MT2 / MT3
 - Double A2 screw for simple further connection of coil supply

Accessories Multimode Relay MT (Continued)

Approvals

VDE Cert. No. 40009096, cULus E135149

Technical data MT78 750/755/760/740/745

Rated voltage/Max. switching voltage AC	240/400 VAC
Rated current	10 A
Dielectric strength	
coil-contact circuit	2500 V _{rms}
open contact circuit	1500 V _{rms}
adjacent contact circuit	2500 V _{rms}
Clearance / creepage coil-contact circuit	≥ 2.8/4 mm
Material group of insulation parts	IIIa
Insulation to IEC 60664-1	
Type of insulation coil-contact circuit	basic
open contact circuit	functional
adjacent contact circuits	basic
Rated insulation voltage	250 V
Pollution degree	2
Rated voltage system	230/400 V
Overvoltage category	III
Material compliance: EU RoHS/ELV, China RoHS, REACH, Halogen content refer to the Product Compliance Support Center at www.te.com/customer-support/rohssupportcenter	
Ambient temperature range	-20...+80°C
Terminals	screw
Terminal screw torque acc. IEC 61984	0.5 Nm
max.	0.7 Nm
Wire strip length	9 mm
Wire cross section	
single wire	2 x 2.5 mm ²
fine wire	2 x 2.5 mm ²
with bootlace crimp (DIN 46228/1)	2 x 1.5 mm ²
Insertion cycles	A (10)
Max. Insertion Force total	100 N
Mounting distance	≥ 0 mm, dense packing
Weight	
MT 78 750/760	54 g
MT 78 755	47 g
MT 78 740	62 g
MT 78 745	56 g
Packaging unit	25 pcs

DIN-rail sockets with screw-type terminals

Type		Part Number
MT 78 750	DIN-rail socket with screw-type terminals, 11-pin	1415035-1
MT 78 755	DIN-rail socket with screw-type terminals, 8-pin	3-1415035-1
MT 78 760	DIN-rail socket with screw-type terminals, 11-pin	8-1415034-1
MT 78 740	DIN-rail socket with screw-type terminals, 11-pin	8-1393163-3
MT 78 745	DIN-rail socket with screw-type terminals, 11-pin	8-1393163-4

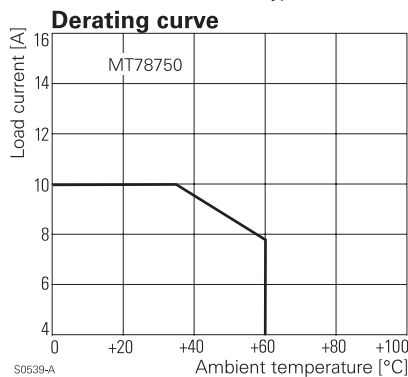

Accessories for MT 78 750, MT 78 755, MT 78 760, MT 78 740, MT 78 745

Type		Part Number
MT 28 800	Metal retaining clip MT	8-1393163-0

LED and Protection modules for MT 78 740, MT 78 745

Type		Part Number
MTM TO 0A0	Protection diode 1N4007 (A1+, A2-)	7-1393163-6
MTM U0 730	RC-network 110...230 VAC	7-1393163-8
MTM LO 024	red LED 24 VAC / VDC	7-1393163-4



Function modules for MT 78 740, MT 78 745

Type		Part Number
MTM ZO W00	Delay ON	7-1393163-9
MTM FO W00	Multifunction	7-1393163-3



Technical data - Function modules

Nominal voltage	24...240 VDC / VAC
Mains frequency	48...63 Hz
Precision of time setting	+ 0.5 %
Readiness for repetition	≤ 0.5 % or 5 ms
Influence of temperature	≤ 0.1 %/°C
Time range switchable	0.05s...240h in 8 ranges
Material compliance: EU RoHS/ELV, China RoHS, REACH, Halogen content refer to the Product Compliance Support Center at www.te.com/customer-support/rohssupportcenter	
Ambient temperature range	-25...+55°C

X-ON Electronics

Largest Supplier of Electrical and Electronic Components

Click to view similar products for [Relay Sockets & Hardware](#) category:

Click to view products by [TE Connectivity](#) manufacturer:

Other Similar products are found below :

[7-1393143-3](#) [7-1616347-8](#) [7-1616350-5](#) [8-1616360-0](#) [8-1616360-6](#) [9-1616339-5](#) [9-1616358-1](#) [9-1616359-7](#) [9-1616360-2](#) [PLC-10](#) [PT08QN](#)
[PT 1/8 D = 3.2](#) [12082001](#) [R99-11 FOR MY\(NAMEPLATE\)](#) [RES100K](#) [1393824-3](#) [13900001](#) [1415526-1](#) [1419106-5](#) [1423683-1](#) [1415037-1](#)
[14486001](#) [1423685-1](#) [MS-24H](#) [16-1328](#) [1616339-8](#) [MT78N60](#) [17540001](#) [20584002](#) [20C419](#) [2-1393102-4](#) [2-1419106-9](#) [2-1608090-1](#)
[P70A AC100/110](#) [PB-4H](#) [21B212](#) [RSE120027](#) [9-1616337-0](#) [9-1616337-6](#) [9-1616358-3](#) [27E1038](#) [27E448](#) [S82Y-RN](#) [2944533](#) [LMC-1](#) [16-](#)
[1340](#) [16154040](#) [9P40X1](#) [17891020](#) [17892040](#)