

# DATA SHEET

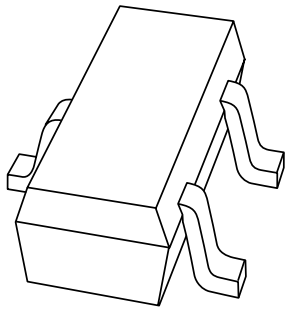

## **BC856T; BC857T series** PNP general purpose transistors

Product data sheet  
Supersedes data of 1999 Apr 26

2000 Nov 15

# PNP general purpose transistors

# BC856T; BC857T series

### FEATURES

- Low current (max. 100 mA)
- Low voltage (max. 65 V).

### APPLICATIONS

- General purpose switching and amplification, especially in portable equipment.

### DESCRIPTION

PNP transistor in an SC-75 (SOT416) plastic package. NPN complements: BC846T; BC847T series.

### MARKING

TYPE NUMBER	MARKING CODE
BC856AT	3A
BC856BT	3B
BC857AT	3E
BC857BT	3F
BC857CT	3G

### PINNING

PIN	DESCRIPTION
1	base
2	emitter
3	collector

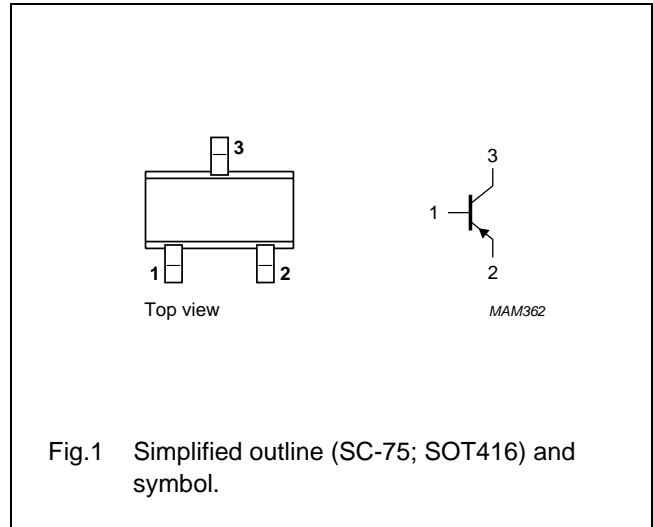

### LIMITING VALUES

In accordance with the Absolute Maximum Rating System (IEC 60134).

SYMBOL	PARAMETER	CONDITIONS	MIN.	MAX.	UNIT
V <sub>CBO</sub>	collector-base voltage	open emitter	–	–80	V
	BC856AT; BC856BT BC857AT; BC857BT; BC857CT		–	–50	V
V <sub>CEO</sub>	collector-emitter voltage	open base	–	–65	V
	BC856AT; BC856BT BC857AT; BC857BT; BC857CT		–	–45	V
V <sub>EBO</sub>	emitter-base voltage	open collector	–	–5	V
I <sub>C</sub>	collector current (DC)		–	–100	mA
I <sub>CM</sub>	peak collector current		–	–200	mA
I <sub>BM</sub>	peak base current		–	–100	mA
P <sub>tot</sub>	total power dissipation	T <sub>amb</sub> ≤ 25 °C; note 1	–	150	mW
T <sub>stg</sub>	storage temperature		–65	+150	°C
T <sub>j</sub>	junction temperature		–	150	°C
T <sub>amb</sub>	operating ambient temperature		–65	+150	°C

### Note

1. Transistor mounted on an FR4 printed-circuit board.

## PNP general purpose transistors

## BC856T; BC857T series

## THERMAL CHARACTERISTICS

SYMBOL	PARAMETER	CONDITIONS	VALUE	UNIT
$R_{th\ j-a}$	thermal resistance from junction to ambient	in free air; note 1	833	K/W

## Note

1. Transistor mounted on an FR4 printed-circuit board.

## CHARACTERISTICS

$T_{amb} = 25\text{ °C}$  unless otherwise specified.

SYMBOL	PARAMETER	CONDITIONS	MIN.	TYP.	MAX.	UNIT
$I_{CBO}$	collector-base cut-off current	$V_{CB} = -30\text{ V}; I_E = 0$	–	–	–15	nA
		$V_{CB} = -30\text{ V}; I_E = 0; T_j = 150\text{ °C}$	–	–	–5	$\mu\text{A}$
$I_{EBO}$	emitter cut-off current	$V_{EB} = -5\text{ V}; I_C = 0$	–	–	–100	nA
$h_{FE}$	DC current gain BC856AT; BC857AT BC856BT; BC857BT BC857CT	$V_{CE} = -5\text{ V}; I_C = -2\text{ mA}$				
			125	–	250	
			220	–	475	
			420	–	800	
$V_{CEsat}$	collector-emitter saturation voltage	$I_C = -10\text{ mA}; I_B = -0.5\text{ mA}$	–	–	–200	mV
		$I_C = -100\text{ mA}; I_B = -5\text{ mA}; \text{note 1}$	–	–	–400	mV
$V_{BE}$	base-emitter voltage	$I_C = -2\text{ mA}; V_{CE} = -5\text{ V}$	–580	–	–700	mV
		$I_C = -10\text{ mA}; V_{CE} = -5\text{ V}$	–	–	–770	mV
$C_c$	collector capacitance	$V_{CB} = -10\text{ V}; f = 1\text{ MHz}; I_E = I_C = 0$	–	–	2.5	pF
$C_e$	emitter capacitance	$V_{EB} = -0.5\text{ V}; f = 1\text{ MHz}; I_C = I_E = 0$	–	10	–	pF
$f_T$	transition frequency	$I_C = -10\text{ mA}; V_{CE} = -5\text{ V}; f = 100\text{ MHz}$	100	–	–	MHz
F	noise figure	$I_C = -200\text{ }\mu\text{A}; V_{CE} = -5\text{ V}; R_S = 2\text{ k}\Omega; f = 1\text{ kHz}; B = 200\text{ Hz}$	–	–	10	dB

## Note

1. Pulse test:  $t_p \leq 300\text{ }\mu\text{s}; \delta \leq 0.02$ .

PNP general purpose transistors

BC856T; BC857T series

GRAPHICAL INFORMATION BC857AT

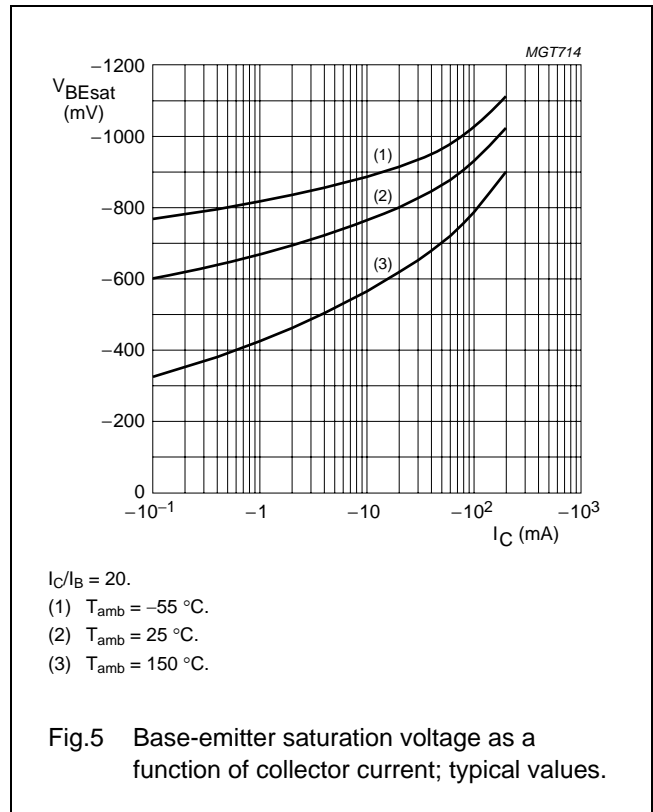
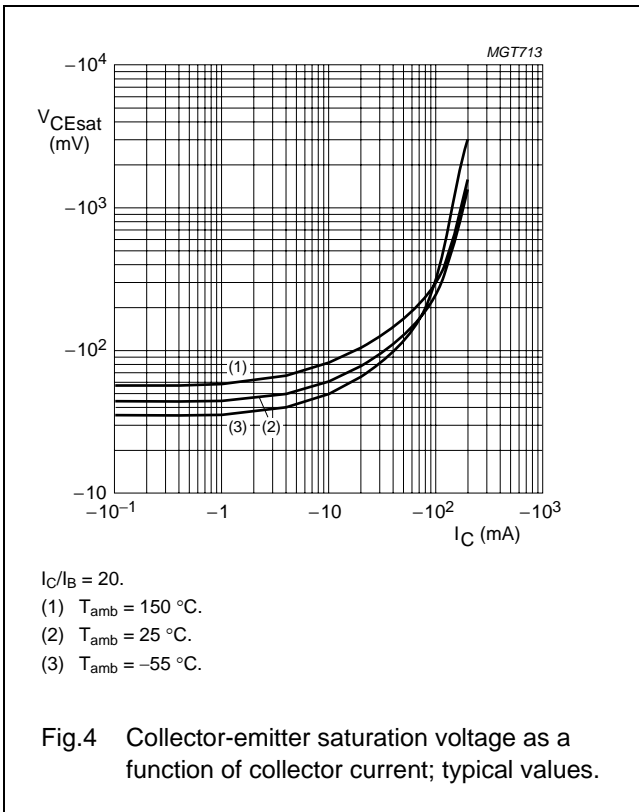
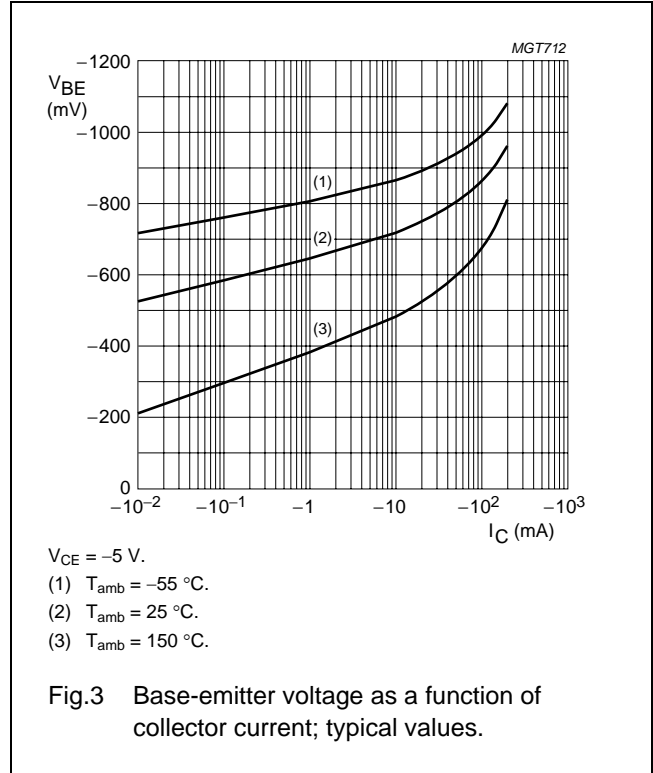
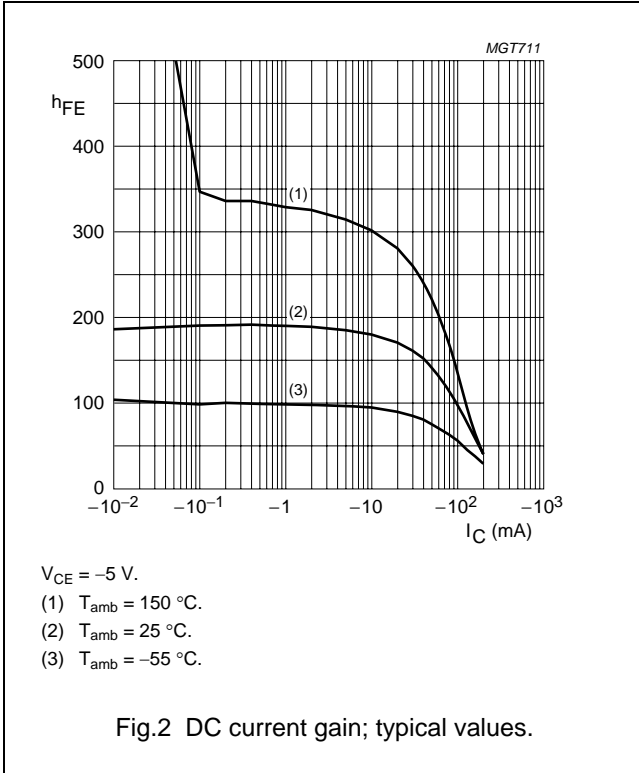

PNP general purpose transistors

BC856T; BC857T series

GRAPHICAL INFORMATION BC857BT

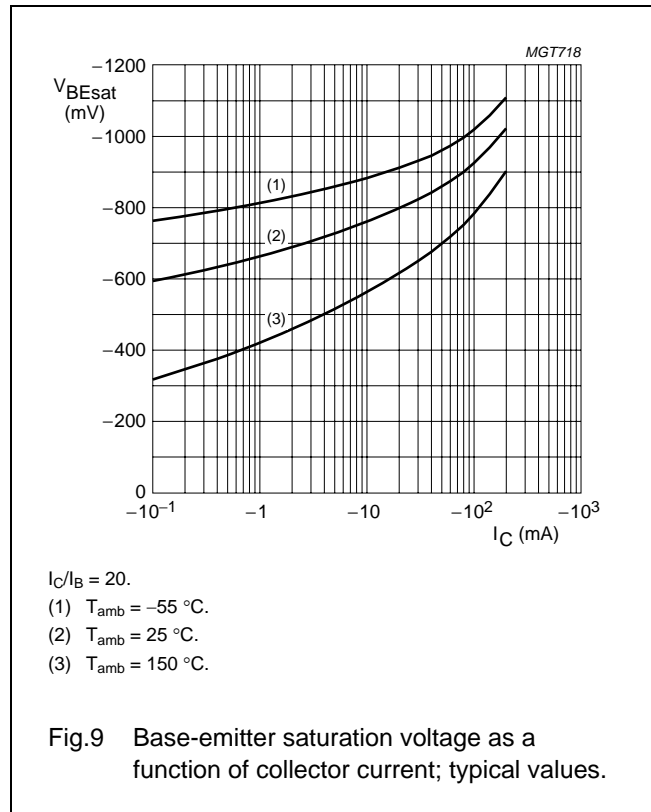
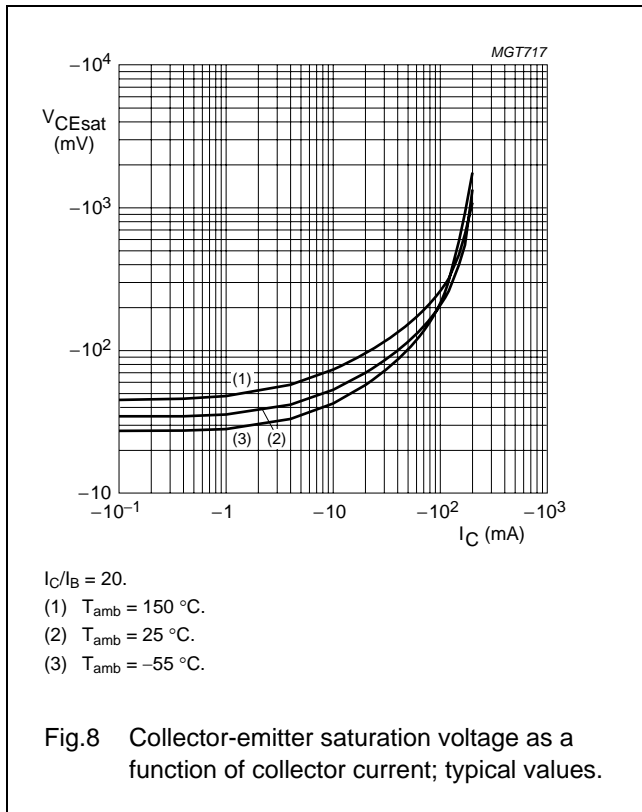
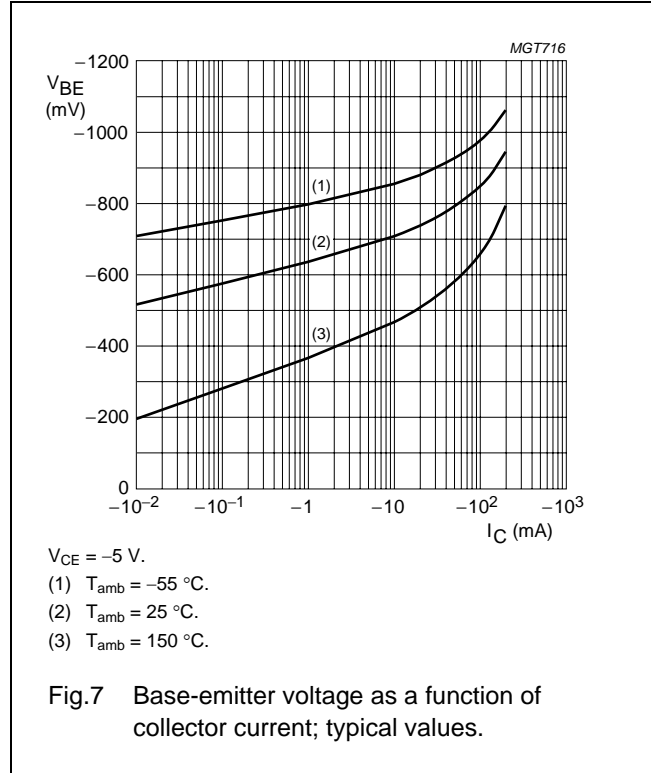
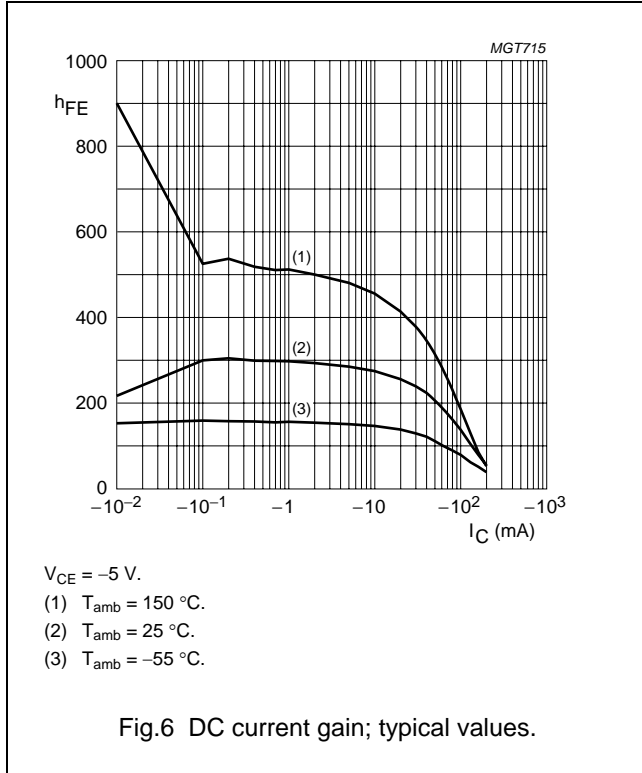

PNP general purpose transistors

BC856T; BC857T series

GRAPHICAL INFORMATION BC857CT

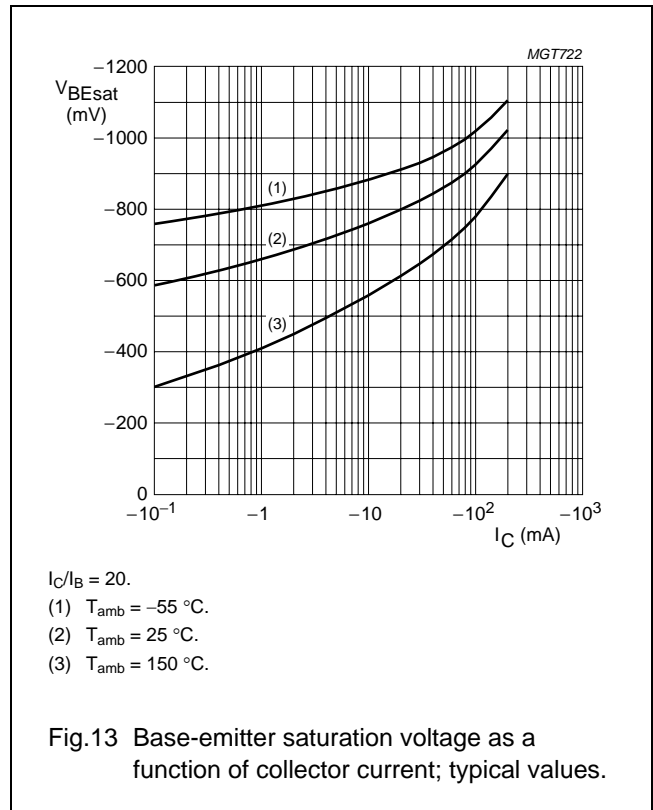
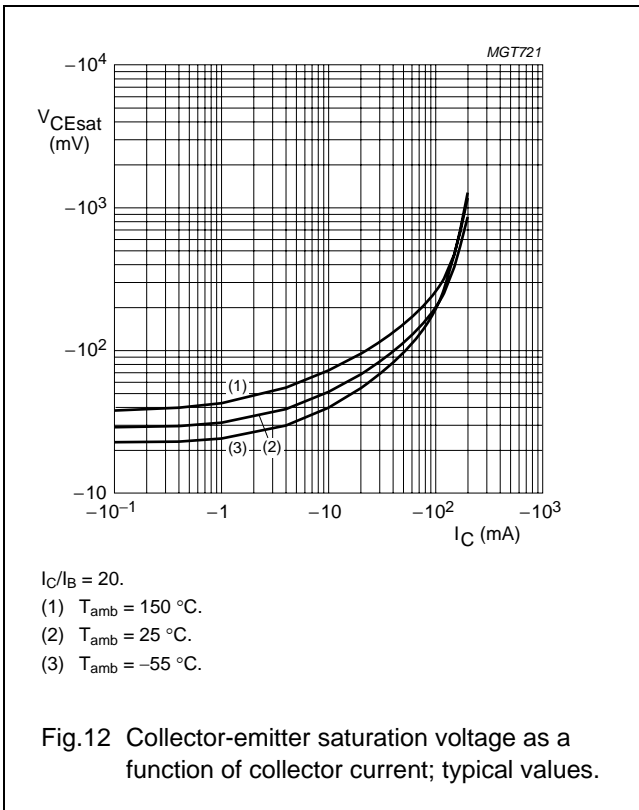
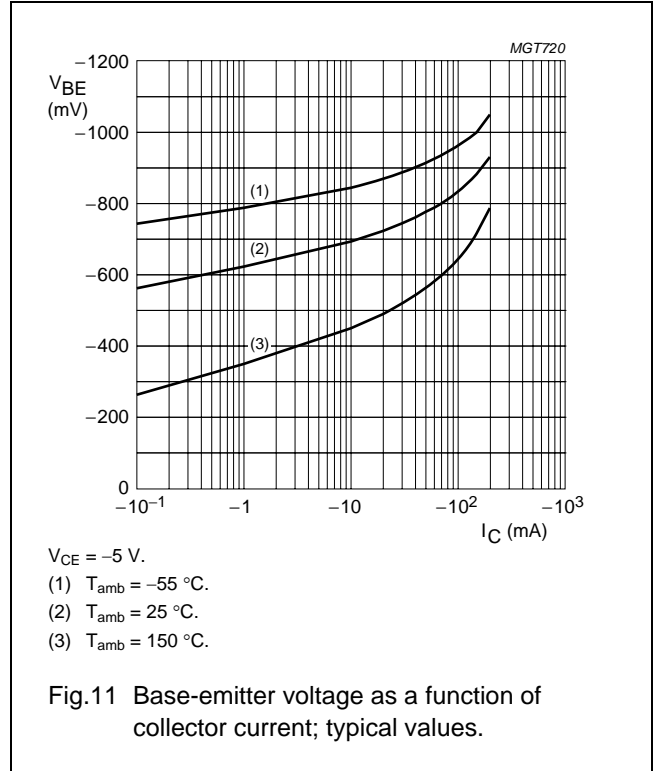
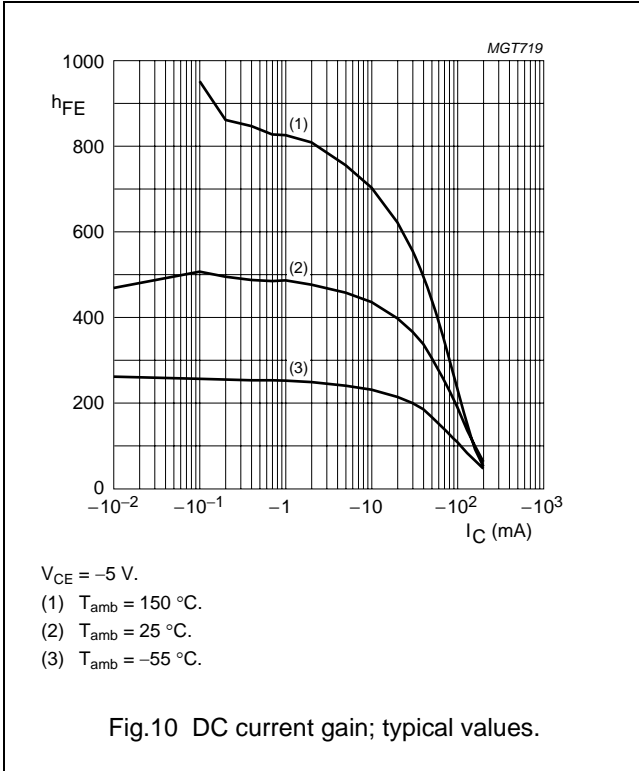

PNP general purpose transistors

BC856T; BC857T series

PACKAGE OUTLINE

Plastic surface mounted package; 3 leads

SOT416

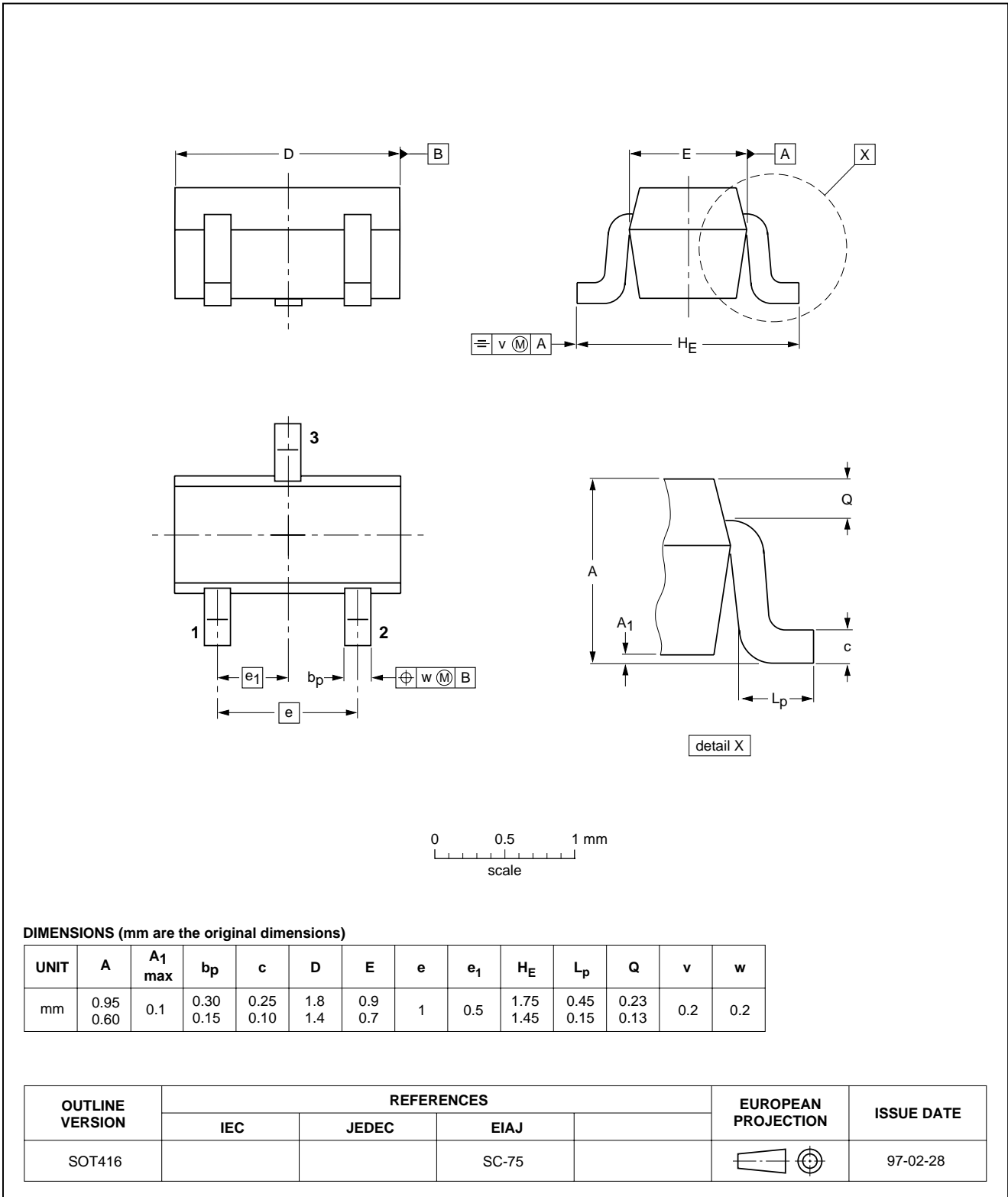

PNP general purpose transistors

BC856T; BC857T series

**DATA SHEET STATUS**

DOCUMENT STATUS <sup>(1)</sup>	PRODUCT STATUS <sup>(2)</sup>	DEFINITION
Objective data sheet	Development	This document contains data from the objective specification for product development.
Preliminary data sheet	Qualification	This document contains data from the preliminary specification.
Product data sheet	Production	This document contains the product specification.

**Notes**

1. Please consult the most recently issued document before initiating or completing a design.
2. The product status of device(s) described in this document may have changed since this document was published and may differ in case of multiple devices. The latest product status information is available on the Internet at URL <http://www.nxp.com>.

**DISCLAIMERS**

**General** — Information in this document is believed to be accurate and reliable. However, NXP Semiconductors does not give any representations or warranties, expressed or implied, as to the accuracy or completeness of such information and shall have no liability for the consequences of use of such information.

**Right to make changes** — NXP Semiconductors reserves the right to make changes to information published in this document, including without limitation specifications and product descriptions, at any time and without notice. This document supersedes and replaces all information supplied prior to the publication hereof.

**Suitability for use** — NXP Semiconductors products are not designed, authorized or warranted to be suitable for use in medical, military, aircraft, space or life support equipment, nor in applications where failure or malfunction of an NXP Semiconductors product can reasonably be expected to result in personal injury, death or severe property or environmental damage. NXP Semiconductors accepts no liability for inclusion and/or use of NXP Semiconductors products in such equipment or applications and therefore such inclusion and/or use is at the customer's own risk.

**Applications** — Applications that are described herein for any of these products are for illustrative purposes only. NXP Semiconductors makes no representation or warranty that such applications will be suitable for the specified use without further testing or modification.

**Limiting values** — Stress above one or more limiting values (as defined in the Absolute Maximum Ratings System of IEC 60134) may cause permanent damage to the device. Limiting values are stress ratings only and operation of the device at these or any other conditions

above those given in the Characteristics sections of this document is not implied. Exposure to limiting values for extended periods may affect device reliability.

**Terms and conditions of sale** — NXP Semiconductors products are sold subject to the general terms and conditions of commercial sale, as published at <http://www.nxp.com/profile/terms>, including those pertaining to warranty, intellectual property rights infringement and limitation of liability, unless explicitly otherwise agreed to in writing by NXP Semiconductors. In case of any inconsistency or conflict between information in this document and such terms and conditions, the latter will prevail.

**No offer to sell or license** — Nothing in this document may be interpreted or construed as an offer to sell products that is open for acceptance or the grant, conveyance or implication of any license under any copyrights, patents or other industrial or intellectual property rights.

**Export control** — This document as well as the item(s) described herein may be subject to export control regulations. Export might require a prior authorization from national authorities.

**Quick reference data** — The Quick reference data is an extract of the product data given in the Limiting values and Characteristics sections of this document, and as such is not complete, exhaustive or legally binding.



# ***NXP Semiconductors***

## **Customer notification**

This data sheet was changed to reflect the new company name NXP Semiconductors. No changes were made to the content, except for the legal definitions and disclaimers.

## **Contact information**

For additional information please visit: **<http://www.nxp.com>**

For sales offices addresses send e-mail to: **[salesaddresses@nxp.com](mailto:salesaddresses@nxp.com)**

© NXP B.V. 2009

All rights are reserved. Reproduction in whole or in part is prohibited without the prior written consent of the copyright owner.

The information presented in this document does not form part of any quotation or contract, is believed to be accurate and reliable and may be changed without notice. No liability will be accepted by the publisher for any consequence of its use. Publication thereof does not convey nor imply any license under patent- or other industrial or intellectual property rights.

Printed in The Netherlands

613514/03/pp9

Date of release: 2000 Nov 15

Document order number: 9397 750 07525



## X-ON Electronics

Largest Supplier of Electrical and Electronic Components

*Click to view similar products for [Bipolar Transistors - Pre-Biased](#) category:*

*Click to view products by [NXP](#) manufacturer:*

Other Similar products are found below :

[MMUN2217LT1G](#) [FP101-TL-E](#) [RN1607\(TE85L,F\)](#) [DRC9A14E0L](#) [DTA124GKAT146](#) [DTA144WETL](#) [DTA144WKAT146](#)

[DTC113EET1G](#) [DTC115TETL](#) [DTC115TKAT146](#) [DTC124TETL](#) [DTC144ECA-TP](#) [DTC144VUAT106](#) [MUN5241T1G](#)

[BCR158WH6327XTSA1](#) [NSBA114TDP6T5G](#) [NSBA143TF3T5G](#) [NSBA143ZF3T5G](#) [NSBC114EF3T5G](#) [NSBC114YF3T5G](#)

[NSBC123TF3T5G](#) [NSBC143TF3T5G](#) [NSVMUN2212T1G](#) [NSVMUN5111DW1T3G](#) [NSVMUN5314DW1T3G](#) [NSVUMC2NT1G](#)

[SMMUN2134LT1G](#) [SMUN2212T1G](#) [SMUN5235T1G](#) [SMUN5330DW1T1G](#) [SSVMUN5312DW1T2G](#) [2SC3650-TD-E](#) [RN1303\(TE85L,F\)](#)

[RN4605\(TE85L,F\)](#) [BCR135SH6327XT](#) [TTEPROTOTYPE79](#) [UMC3NTR](#) [DTA113EET1G](#) [EMA2T2R](#) [EMH15T2R](#) [SDTA114YET1G](#)

[SMMUN2111LT3G](#) [SMMUN2113LT1G](#) [SMMUN2114LT1G](#) [SMMUN2211LT3G](#) [SMUN2214T3G](#) [SMUN5113DW1T1G](#)

[SMUN5335DW1T1G](#) [NSBA114YF3T5G](#) [NSBC114TF3T5G](#)