

U.I. Lapp GmbH	<h1>DATASHEET</h1>	
	<b>EPIC® KIT M23 D6 12-POL FEMALE</b>	75009702 29.11.2013

Inserts for M23 circular connectors

Universal further processing of the M23 inserts through different packaging units. Fully assembled with suitable solder contacts or unpopulated for individual assembly with crimp or solder contacts



Good chemical resistance



Industrial machinery and plant engineering



Mechanical resistance



Assembly time



Robust



Wind Energy



Variety of approval certifications

### Application range

Plant engineering  
Measurement and control technology  
Apparatus construction

### Remark

The inserts are suitable for both male and female contacts. For a complete connection, you will need one P-component and one E-component. P-component = left turning (anticlockwise), E-component = right turning (clockwise)  
Photographs are not to scale and do not represent detailed images of the respective products.

Product Management	Document: EPIC® KIT M23 D6 12-POL FEMALE	1 / 6
--------------------	--	-------

U.I. Lapp GmbH	<b>DATASHEET</b>	
	<b>EPIC® KIT M23 D6 12-POL FEMALE</b>	<b>75009702</b> <b>29.11.2013</b>

### Technical Data

Article number:	75009702
Rated voltage (V):	according to IEC 61984: 100 V
Rated impulse voltage:	1.5 kV
Rated current (A):	7 A
Contact resistance:	< 4 mOhm
Contacts:	Gold-plated brass
Number of contacts:	12
Termination methods:	Crimp termination: 0.14 - 1.0 mm <sup>2</sup> Solder termination: up to 1.0 mm <sup>2</sup>
Cycle of mechanical operation:	100
Temperature range:	-25°C až +125°C
VDE-tested:	Certified production control: VDE-REG. no. C24 (according to EN 61984, SELV according to DIN VDE 0100-410 has to be guaranteed) UL File Number: E249137
Degree of soiling:	3

Product Management	Document: EPIC® KIT M23 D6 12-POL FEMALE	2 / 6
--------------------	--	-------

U.I. Lapp GmbH	<h1>DATASHEET</h1>	
	<b>EPIC® KIT M23 D6 12-POL FEMALE</b>	75009702 29.11.2013



Product Management	Document: EPIC® KIT M23 D6 12-POL FEMALE	3 / 6
--------------------	--	-------

U.I. Lapp GmbH	<b>DATASHEET</b>	 <b>LAPP GROUP</b>
	<b>EPIC® KIT M23 D6 12-POL FEMALE</b>	75009702 29.11.2013

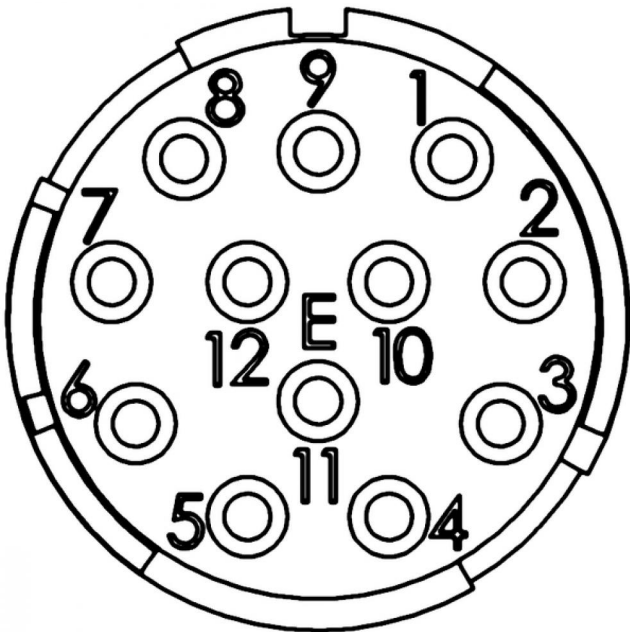
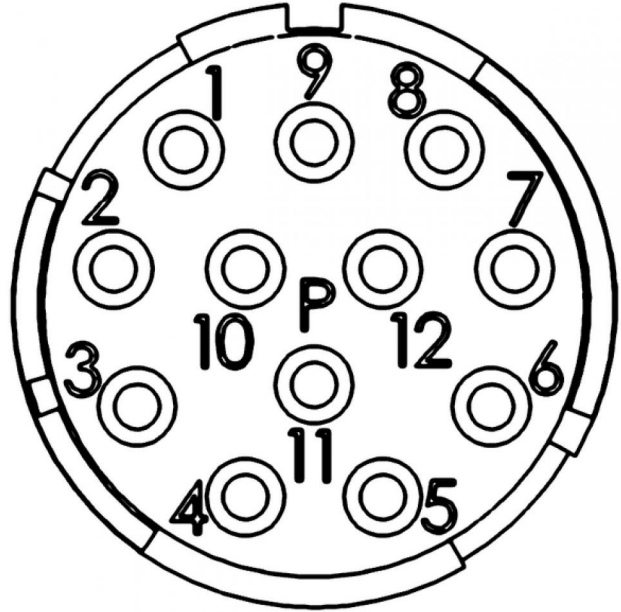

Product Management	Document: EPIC® KIT M23 D6 12-POL FEMALE	4 / 6
--------------------	--	-------

U.I. Lapp GmbH	<b>DATASHEET</b>	
	<b>EPIC® KIT M23 D6 12-POL FEMALE</b>	75009702 29.11.2013

Circular connectors for Servo Cables and encoders  
Low-resistance screen contact, optimum EMC protection  
Use of high quality materials for increased reliability



Good chemical resistance



Industrial machinery and plant engineering



Optimum strain relief



Robust



Integrated SKINTOP® cable gland



Wind Energy



### Info

Robust metal connector with integrated EMC cable gland

### Application range

Plant engineering  
Servo drives and servo assemblies  
Measurement and control technology

### Remark

Photographs are not to scale and do not represent detailed images of the respective products.

### Technical Data

Article number:	75009702
Material:	Housing: nickel-plated zinc die-casting Sealing: FPM
Protection rating:	IP68 (10h / 1m)
Temperature range:	-25°C až +125°C
VDE-tested:	Certified production control: VDE-REG. no. C24 (according to EN 61984, SELV according to DIN VDE 0100-410 has to be guaranteed) UL File Number: E249137

Product Management	Document: EPIC® KIT M23 D6 12-POL FEMALE	5 / 6
--------------------	--	-------

U.I. Lapp GmbH	<h1>DATASHEET</h1>	
	<b>EPIC® KIT M23 D6 12-POL FEMALE</b>	75009702 29.11.2013

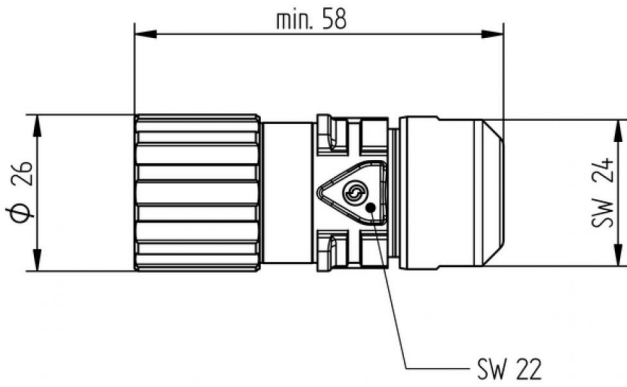

Product Management	Document: EPIC® KIT M23 D6 12-POL FEMALE	6 / 6
--------------------	--	-------

## X-ON Electronics

Largest Supplier of Electrical and Electronic Components

*Click to view similar products for [Circular MIL Spec Connector](#) category:*

*Click to view products by [Lapp Kabel](#) manufacturer:*

Other Similar products are found below :

[89075GULPR](#) [0025-262-542](#) [0025-264-3014](#) [58-570121-04S](#) [0134-213-1208](#) [0134-213-2209](#) [0025-258-000](#) [60-042022-07P](#) [60-042022-19P](#)  
[60-042022-23P](#) [60-042217-10P](#) [0114-201-1278](#) [012-0467-000](#) [602GB06EG24-61SN](#) [0134-201-1207](#) [0134-213-1006](#) [6104-207-2302](#) [6104-](#)  
[208-1902](#) [61-168211-04P](#) [61-168617-10P](#) [6131-202-19149P](#) [6131-204-21149P](#) [6131-208-13149P](#) [6131-209-17149P](#) [6131-210-11149P](#) [6131-](#)  
[211-19149P](#) [6131-216-19149P](#) [6131-259-21149P](#) [6131-259-23149P](#) [6131-265-17149P](#) [6131-265-19149P](#) [CS3100A18-1P-472](#) [CS3100A-36-](#)  
[77P](#) [CS3101A-16-55P](#) [CS3102A-10SL-55P](#) [CS3102A-14S-58P](#) [CS3102A-32-17P](#) [CS3102A32-25S](#) [CS3102C18-4P-472](#)  
[CS3106A10SL3S004](#) [CS3106A-18-73S](#) [CS3108A-14S-52S](#) [CS3108A-28-51S](#) [6162-233-1277](#) [6162-324-1231](#) [M243082296Z](#)  
[M2884010AC1S1](#) [CT0-24-10SC](#) [CT0M20-7PCAU](#) [M28840/17AC1G3](#)