



Quick Reference Guide

AMP CT Connector Series

The AMP CT connectors are a miniature wire-to-board and wire-to-wire interconnect solution. The AMP CT connector series has proven performance in its harness making capability. A variety of harness-making machines are available ranging from hand tools for low volume production to high-speed automatic crimping machines for medium to high volume productions. AMP high-speed automatic crimping machines are easy to operate, eliminating the need for tedious work of changing parts inside the equipment to adapt to changes in harness styles. Two types of housings are available, including Crimp and Mass Terminated (MT), which are preloaded with insulation displacement contacts. The Box or shrouded headers are highly resistant to scooping at mating/unmating.

FEATURES AND BENEFITS

- 2 kinds of termination method: IDC, Crimp
- Discrete wire interconnect
- Circuits range from 2-30
- AWG 22-30
- Kinks for self-retention on boards
- RoHS compliant
- Recognized under the component program of Underwriters Laboratories Inc., file No. E28476
- Certified by Canadian Standards Association, File No. LR 7189-133

PRODUCT APPLICATIONS

- Business Equipment
- Industrial Machines
- PC
- Printer
- Fax
- C-TV
- Audio
- Air conditioner
- Anywhere where signals or power are routed

How to select an AMP CT connector part number

The charts on this page highlight the relationship between the number of contacts (positions) to the part number. Please see the sample chart below that was designed to help you select the correct part number for your needs. For single digit position to dash numbers, attach the digit to the end base number. For double digit position to dash numbers, attach the first digit to the front of the part number, add a dash and the base part number, then follow the base part number with a dash and the second digit.

| Example Base Part Number | Your Criteria | Example Position to Dash Selection | End Part Number Based on Criteria | | | | | |
|--------------------------|--|------------------------------------|-----------------------------------|----|-----|-----|-----|------------|
| | | Position | 8 | 9 | 10 | 11 | 12 | |
| 173977 | You require and 8 position MT housing | Dash Number | -8 | -9 | -10 | -11 | -12 | 173977-8 |
| 173977 | You require and 12 position MT housing | Dash Number | -8 | -9 | -10 | -11 | -12 | 1-173977-2 |

Cable Side Connectors

Mass Termination (MT) vs. Crimp Poke

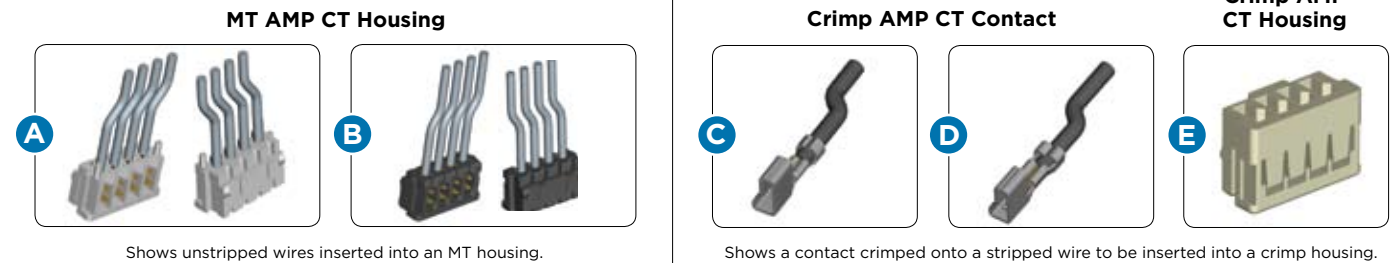

CRIMP TYPE CONNECTORS : Contacts

| Description | PN | Photo | Specifications |
|---|----------|-------|----------------|
| Receptacle Contact - Strip - AWG : 26-30 | 179609-1 | C | D,Y |
| Receptacle Contact - Loose Piece - AWG : 26-30 | 179610-1 | C | D,Y |
| Receptacle Contact - Strip - AWG : 22-26 | 179227-1 | D | D,Y |
| Receptacle Contact - Strip - AWG : 22-26 - Gold plated | 179227-4 | D | D,Y |
| Receptacle Contact - Loose Piece - AWG : 22-26 - receptacle | 179518-1 | D | D,Y |

CRIMP TYPE CONNECTORS : Housing

| Description | PN | Photo | Position to Dash | | | | | | | | | | | | | | |
|---|--------|-------|----------------------|----|----|----|----|----|----|----|-----|-----|-----|-----|-----|-----|--|
| | | | 2 | 3 | 4 | 5 | 6 | 7 | 8 | 9 | 10 | 11 | 12 | 13 | 14 | 15 | |
| Receptacle Housing | 179228 | E | -2 | -3 | -4 | -5 | -4 | -7 | -8 | -9 | -10 | -11 | -12 | -13 | -14 | -15 | |
| Mating PNS : 292253; 292161; 292250; 292164; 292133; 292132; 292165; 292173; 292171; 292172; 292134; 176394; 292138; 292252; 292141; 292254; 292156; 292204; 292177; 292178; 292185; 292182; 292181 | | | Specifications : D,Y | | | | | | | | | | | | | | |

MASS TERMINATION (MT) CONNECTORS : Pre-Loaded Receptacle Housing

| Description | PN | Photo | Position to Dash | | | | | | | | | | | | | | |
|---|--------|-------|----------------------|----|----|----|----|----|----|----|-----|-----|-----|-----|-----|-----|--|
| | | | 2 | 3 | 4 | 5 | 6 | 7 | 8 | 9 | 10 | 11 | 12 | 13 | 14 | 15 | |
| MT receptacle housing (wire application) = AWG : 26-28 | 173977 | A | -2 | -3 | -4 | -5 | -4 | -7 | -8 | -9 | -10 | -11 | -12 | -13 | -14 | -15 | |
| MT receptacle housing (wire application) = AWG : 24 | 179694 | B | -2 | -3 | -4 | -5 | -4 | -7 | -8 | -9 | -10 | -11 | -12 | -13 | -14 | -15 | |
| Mating PNS : 292253; 292161; 292250; 292164; 292133; 292132; 292165; 292173; 292171; 292172; 292138; 292252; 292141; 292254; 292156; 292204; 292178; 292182; 175133; 179608 | | | Specifications : C,X | | | | | | | | | | | | | | |
| MT Receptacle Housing - Au Plated (Wire Application) = AWG: 26~28 | 176392 | A | -2 | -3 | -4 | -5 | -4 | -7 | -8 | -9 | -10 | -11 | -12 | -13 | -14 | -15 | |
| Mating PNS : 292134; 176394 | | | Specifications : C,X | | | | | | | | | | | | | | |

Cable Side Connectors : Tooling Options

APPLICATION TOOLING

| Connector PN | Tooling PN | Description | Application Spec. |
|--------------------|------------|-------------------------------|-------------------|
| 1385047-3* | 1385047-3* | Applicator | 408-8040 |
| 1739772-2 thru -15 | 58074-1 | Manual Handle without head | 408-6790 |
| | 58372-1 | 2 mm AMP CT (IDC) Head | 408-9426 |
| 176392-2 thru -15 | 58473-2 | AMP CT MT Mini Air Terminator | - |
| 179610-1 | 1385047-3* | Applicator | 408-8040 |
| 179227-1 | 680216-3* | Applicator | 408-8040 |
| 179227-4 | 680216-3* | Applicator | 408-8040 |
| 179518-1 | 91572-1** | CERTI-CRIMP Hand Tool | 408-8547 |

* Applicators listed are used in the AMP-O-ELECTRIC Model G, AMP 3K/40 and AMP 5K/40 Terminators. Call the Tooling Assistance Center at 800-722-1111 for applicator numbers for Automatic Cut, Strip and Terminate Leadmakers.
 ** Power tooling options are also available. Call Tooling Sales at 888-777-5917 (717-810-2080) for more information

PCB Side Connectors (Single Row + Dual Row)

Common AMP CT Terminology

Locating Boss

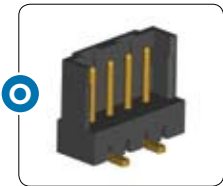
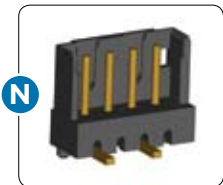

A boss is a mechanical feature that helps orientate the headers onto the PCB.

Without Kinked Leg

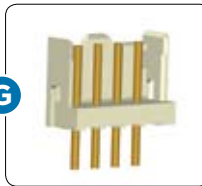
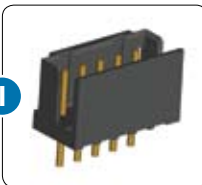

Kinked legs are designed to secure the T/H headers onto the PCB.

With Kinked Leg



Solder Tabs

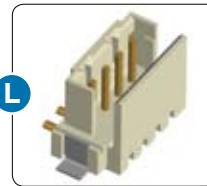
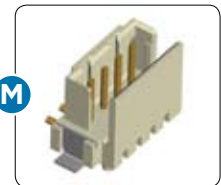

Solder tabs are designed to secure the SMT headers onto the PCB.

Mount Styles

Header Styles

Card Edge



Box

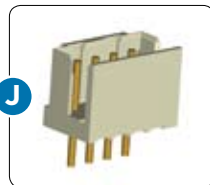

Box headers offer a front and back wall for polarization of the connector.

Standard

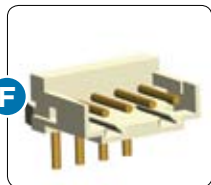

Standard headers offer only a single wall for polarization of the connector.

Free Hanging



Panel Mount

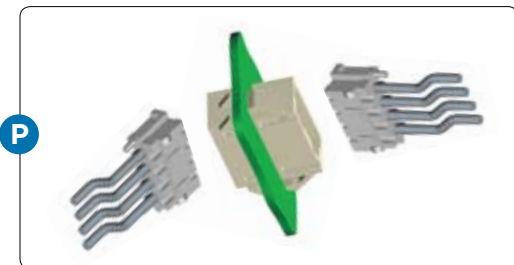

Dual Row Assemblies

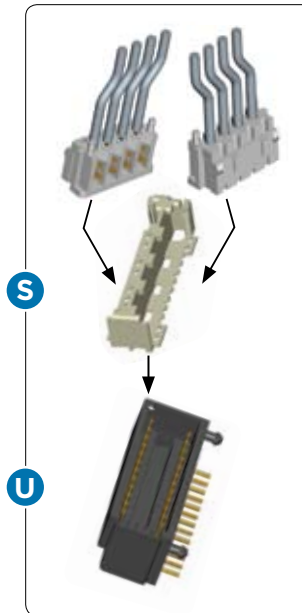

Two Single Row Housings

Captivating Holder

Dual Row Header

Requires a holder to be used along with two single row housings.

Additional Parts

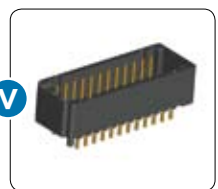

| SINGLE ROW POST HEADER ASSEMBLIES BOARD-MOUNT | | | | | | | | | | | | | | | | | |
|---|---------|--------|-------|------------------|-----|-----|-----|-----|-----|-----|-----|-----|-----|-----|-----|-----|-----|
| Description | Plating | PN | Photo | Position to Dash | | | | | | | | | | | | | |
| | | | | 2 | 3 | 4 | 5 | 6 | 7 | 8 | 9 | 10 | 11 | 12 | 13 | 14 | 15 |
| TH Std Type - Horizontal Mount w/ Kink | TIN | 292253 | F | -2 | -3 | -4 | -5 | -6 | -7 | -8 | -9 | -10 | -11 | -12 | -13 | -14 | -15 |
| TH Std Type - Vertical Mount w/ Kink | TIN | 292161 | G | -2 | -3 | -4 | -5 | -6 | -7 | -8 | -9 | -10 | -11 | -12 | -13 | -14 | -15 |
| TH Box Type - Horizontal Mount w/ Kink | TIN | 292250 | H | -2 | -3 | -4 | -5 | -6 | -7 | -8 | -9 | -10 | -11 | -12 | -13 | -14 | -15 |
| TH Box Type - Vertical Mount w/o Kink | TIN | 292133 | I | -2 | -3 | -4 | -5 | -6 | -7 | -8 | -9 | -10 | -11 | -12 | -13 | -14 | -15 |
| TH Box Type - Vertical Mount w/ Kink | TIN | 292132 | J | -2 | -3 | -4 | -5 | -6 | -7 | -8 | -9 | -10 | -11 | -12 | -13 | -14 | -15 |
| SMT Box Type - Horizontal Mount Type w/ Solder Tab, w/o Boss | TIN | 292173 | K | -22 | -23 | -24 | -25 | -26 | -27 | -28 | -29 | | | | | | |
| SMT Box Type - Horizontal Mount Type w/ Solder Tab, w/ Boss | TIN | 292173 | K | -2 | -3 | -4 | -5 | -6 | -7 | -8 | -9 | | | | | | |
| SMT Box Type - Vertical Mount Type w/ Solder Tab, w/o Boss | TIN | 292175 | L | -22 | -23 | -24 | -25 | -26 | -27 | -28 | -29 | | | | | | |
| SMT Box Type - Vertical Mount Type w/ Solder Tab, w/ Boss (Natural) | TIN | 292174 | M | -2 | -3 | -4 | -5 | -6 | -7 | -8 | -9 | | | | | | |
| SMT Box Type - Vertical Mount Type w/ Solder Tab, w/ Boss (Black) | TIN | 292174 | M | -22 | -23 | -24 | -25 | -26 | -27 | -28 | -29 | | | | | | |
| SMT Std Type - Vertical Mount w/ Boss | TIN | 292171 | N | -2 | -3 | -4 | -5 | -6 | -7 | -8 | -9 | | | | | | |
| SMT Std Type - Vertical Mount w/o Boss | TIN | 292172 | O | -2 | -3 | -4 | -5 | -6 | -7 | -8 | -9 | | | | | | |
| Mating PNS : (MT) 173977; 179694 or (Crimp) 179228 w/ contact Specifications : A, D | | | | | | | | | | | | | | | | | |
| TH Box Type - Vertical Mount w/ Kink | Gold | 292134 | J | -2 | -3 | -4 | -5 | -6 | | | -9 | -10 | | -12 | | | -15 |
| TH Box Type - Horizontal Mount w/ Kink | Gold | 176394 | H | -2 | | -4 | | -6 | | -8 | | -10 | | | | | |
| Mating PNS : (MT) 173977; 179694 or (Crimp) 179228 w/ 179227-4 Specifications : A (292134)/ C (176394), D | | | | | | | | | | | | | | | | | |

| RECEPTACLE CONNECTOR HOLDERS FOR DUAL ROW HEADERS | | | | | | | | | | | | | | | | | |
|--|--------|-------|------------------|-----|-----|-----|-----|-----|-----|-----|-----|-----|--|--|--|--|--|
| Description | PN | Photo | Position to Dash | | | | | | | | | | | | | | |
| | | | 8 | 12 | 16 | 18 | 20 | 22 | 24 | 26 | 28 | 30 | | | | | |
| Receptacle Housing Captivating Holder (MT) | 175133 | R | -8 | -12 | -16 | -18 | -20 | -22 | -24 | -26 | -28 | -30 | | | | | |
| Receptacle Housing Captivating Holder - Reinforced Retention (MT) | 179608 | S | | | -16 | -18 | -20 | -22 | -24 | -26 | -28 | -30 | | | | | |
| Mating PNS : 2x (MT) 173977, 176392 or 179695 Specifications : B | | | | | | | | | | | | | | | | | |
| Receptacle Housing Captivating Holder - Reinforced Retention (Crimp) | 179472 | T | -8 | -12 | -16 | -18 | -20 | -22 | -24 | -26 | -28 | -30 | | | | | |
| Mating PNS : 2 x (Crimp) 179228 w/ contact Specifications : B | | | | | | | | | | | | | | | | | |

| DUAL ROW POST HEADER ASSEMBLIES - BOARD-MOUNT | | | | | | | | | | | | | | | | | |
|---|--------|-------|------------------|-----|-----|-----|-----|-----|-----|-----|-----|-----|--|--|--|--|--|
| Description | PN | Photo | Position to Dash | | | | | | | | | | | | | | |
| | | | 8 | 12 | 16 | 18 | 20 | 22 | 24 | 26 | 28 | 30 | | | | | |
| Horizontal Mount w/ Boardlocks | 292138 | U | -8 | -12 | -16 | -18 | -20 | -22 | -24 | -26 | -28 | -30 | | | | | |
| Vertical Mount w/o Boss | 292252 | V | | | -16 | -18 | -20 | -22 | -24 | -26 | -28 | -30 | | | | | |
| Vertical Mount w/ Boss | 292141 | V | | | -16 | -18 | -20 | -22 | -24 | -26 | -28 | -30 | | | | | |
| Complementary PNS : 175133, 179608 or 179472 w/ 2 x (MT) or 2 x (Crimp) HDRS Specifications : B | | | | | | | | | | | | | | | | | |

| CARD-EDGE CONNECTORS | | | | | | | | | | | | | | | | | |
|----------------------------|--------|-------|------------------|---|---|---|----|---|----|---|----|--|--|--|--|--|--|
| Description | PN | Photo | Position to Dash | | | | | | | | | | | | | | |
| | | | 2 | 3 | 4 | 5 | 6 | 7 | 8 | 9 | 10 | | | | | | |
| AMP CT Card-Edge Connector | 292204 | W | | | | | -1 | | -2 | | | | | | | | |
| Specifications : E | | | | | | | | | | | | | | | | | |

| SINGLE ROW PANEL-MOUNT HEADERS | | | | | | | | | | | | | | | | | |
|--|--------|-------|------------------|----|----|----|----|----|----|----|-----|-----|-----|-----|-----|-----|--|
| Description | PN | Photo | Position to Dash | | | | | | | | | | | | | | |
| | | | 2 | 3 | 4 | 5 | 6 | 7 | 8 | 9 | 10 | 11 | 12 | 13 | 14 | 15 | |
| Panel Mount Header | 292254 | P | -2 | -3 | -4 | -5 | -4 | -7 | -8 | -9 | -10 | -11 | -12 | -13 | -14 | -15 | |
| Mating PNS : (MT) 173977; 179694 or (Crimp) 179228 w/ contact Specifications : A,D | | | | | | | | | | | | | | | | | |

| SINGLE ROW POST FREE-HANGING WIRE TO WIRE HEADERS | | | | | | | | | | | | | | | | | |
|--|--------|-------|------------------|----|----|----|----|---|---|---|----|----|----|----|----|----|--|
| Description | PN | Photo | Position to Dash | | | | | | | | | | | | | | |
| | | | 2 | 3 | 4 | 5 | 6 | 7 | 8 | 9 | 10 | 11 | 12 | 13 | 14 | 15 | |
| Free Hanging Header | 292156 | Q | -2 | -3 | -4 | -5 | -6 | | | | | | | | | | |
| Mating PNS : (MT) 173977; 179694 or (Crimp) 179228 w/ contact Specifications : A,D | | | | | | | | | | | | | | | | | |

AMP CT Connector Series

Product/Application Specification

| | | RATINGS | | | | | |
|---------------|-----------|---------------|--------|--------|--------|--------|--------|
| Product Specs | | Voltage | 22 AWG | 24 AWG | 26 AWG | 28 AWG | 30 AWG |
| A | 108-60016 | 125 V (AC/DC) | | 3 | 2 | 1 | |
| B | 108-60020 | 125 V (AC/DC) | | | 1 | 1 | |
| C | 108-5218 | 125 V AC | | 3 | 2 | 1 | |
| D | 108-60029 | 125 V AC | 4 | 3 | 2.5 | 1.5 | 1 |
| E | 108-60024 | 125 V AC | | | 1 | | |
| F | 108-60021 | 125 V AC | | | 1 | | |

| Application Specs | |
|-------------------|----------|
| X | 114-5014 |
| Y | 114-5179 |
| Z | 114-5103 |

AMP CT Mount Styles

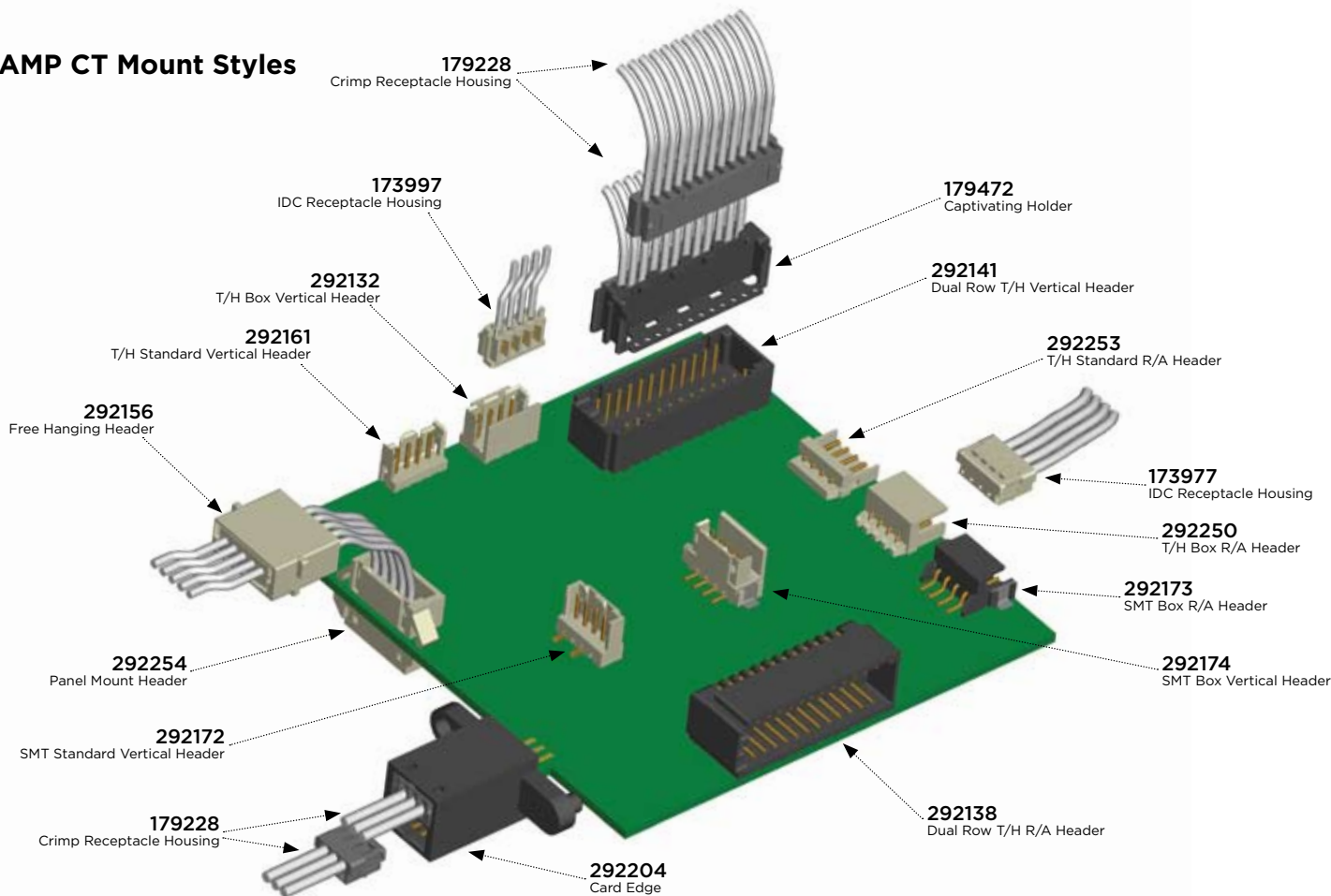

Waldom CT Design Kits*

| Waldom CT Design Kits | |
|-----------------------|---------------------------------|
| PN | Description |
| 2110829-1 | AMP CT Deluxe Kit |
| 2110829-2 | AMP CT R/A Header |
| 2110829-3 | AMP CT Vertical Header |
| 2110829-4 | AMP CT R/A Box Header |
| 2110829-5 | AMP CT Box Vertical Header |
| 2110829-6 | AMP CT Panel Mount |
| 2110829-7 | AMP CT Dual Row R/A Header |
| 2110829-8 | AMP CT Dual Row Vertical Header |

*Design kits are designed and assembled by Waldom and are available for purchase through your local distribution channel.



Questions to ask at Design In stage

What wire gauge will you be using? More flexibility with AWG when using Crimp vs. MT. Crimp housings accept 22-30 AWG and MT housings accept 24-28 AWG.

Are the connectors available for IDC? Yes, we offer a MT version that is preloaded with IDC contacts.

Is your process automated? MT housings are more suitable for automated processes.

Where can I find information on current rating, voltage and operating temperatures? Please see Product Specification Information on page 4 of this QRG.

Which is a more standard header, with or without a locating boss? The most standard headers tend to have a locating boss as it makes it easier for the customer to align the connector onto their board.

What special retention mechanisms are available to help ensure PCB stability? Most of the T/H headers have kinked legs, and the SMT headers have solder tabs to help ensure PCB stability.

What are my tooling options? Tyco Electronics offers comprehensive tooling options including Manual Pistol-Grips, manual Mini-Press, Pneumatic Mini-press, Semi-Auto DECAM and an Automatic DECAM tool. For more information, please visit tooling.tycoelectronics.com

What is the benefit of choosing Box over Std type headers? Box type headers have an extra wall, that is a more reliable connector design intended to prevent stubbing.

e-Catalog

www.tycoelectronics.com/products/ct

Breakdown from main page :

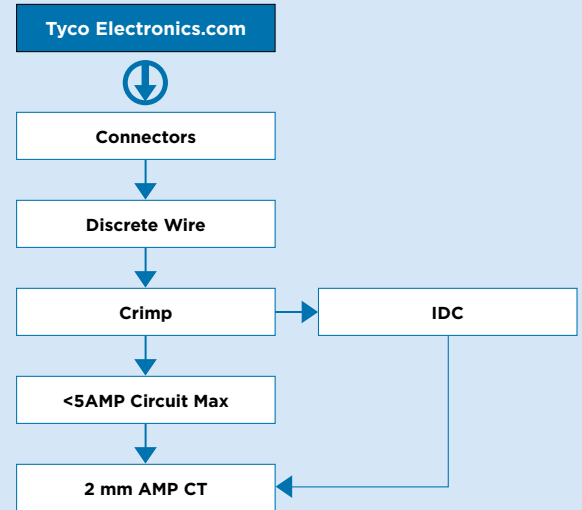

FOR MORE INFORMATION

Technical Support

| | |
|---------------------------|--|
| Internet: | www.tycoelectronics.com/help |
| USA: | +1 (800) 522-6752 |
| Canada: | +1 (905) 470-4425 |
| Mexico & Central America: | +52(0) 55-1106-0814 |
| South America: | +55 (0) 11-2103-6000 |
| Germany: | +49 (0) 6251-133-1999 |
| UK: | +44 (0) 8706-080208 |
| France: | +33 (0) 1-3420-8686 |
| Netherlands: | +31 (0) 73-6246-999 |
| China: | +86 (0) 400-820-6015 |

Part numbers in this brochure are RoHS Compliant*, unless marked otherwise.

*as defined www.tycoelectronics.com/leadfree

Tyco Electronics Corporation, Harrisburg, PA

tycoelectronics.com

© 2009 Tyco Electronics Corporation. All Rights Reserved.

1-1773455-8 CIS FP 1M 09/2009

AMP, AMP 3K/40, AMP 3K/50, AMP-O-LECTRIC, DECAM, TE (logo) and Tyco Electronics are trademarks of the Tyco Electronics group of companies and its licensors.

Other products, logos, and Company names mentioned herein may be trademarks of their respective owners.

While Tyco Electronics has made every reasonable effort to ensure the accuracy of the information in this catalog, Tyco Electronics does not guarantee that it is error-free, nor does Tyco Electronics make any other representation, warranty or guarantee that the information is accurate, correct, reliable or current. Tyco Electronics reserves the right to make any adjustments to the information contained herein at any time without notice. Tyco Electronics expressly disclaims all implied warranties regarding the information contained herein, including, but not limited to, any implied warranties of merchantability or fitness for a particular purpose. The dimensions in this catalog are for reference purposes only and are subject to change without notice. Specifications are subject to change without notice. Consult Tyco Electronics for the latest dimensions and design specifications.

 **Tyco Electronics**
Our commitment. Your advantage.

X-ON Electronics

Largest Supplier of Electrical and Electronic Components

Click to view similar products for te connectivity manufacturer:

Other Similar products are found below :

[570416-000](#) [CLTEQ-M81CE-SSRELAY-4-20V](#) [4-1633138-8](#) [D38999/24FJ4AN](#) [4-1195131-0](#) [650069-000](#) [SMD100-2](#) [2EDL4CM](#)
[DTS20W19-11PD-3028](#) [DTS20W19-11PD-3028-LC](#) [DTS20W19-32SD-3028-LC](#) [DTS20W19-32SD-3028](#) [NC6-P104-06](#) [TXR64AB90-](#)
[3616AI](#) [DTS26F21-41HE](#) [DTS26F21-41AE](#) [DTS26F21-41PE-LC](#) [DTS26F21-11SE-3028-LC](#) [D38999/24WF32JE](#) [D38999/24WF32SE-LC](#)
[DTS24W19-32HE](#) [D38999/20JB35HA](#) [D38999/24WJ20PA](#) [164-8033-08](#) [D38999/24FF32JE](#) [D38999/24FF32SE-LC](#) [D38999/24WF32JB](#)
[D38999/24WG11HA](#) [D38999/24WG11HN](#) [MS27467T21F11H](#) [DJT16E21-11HA](#) [DTS24F19-32HE](#) [DTS20W19-32SA-3028-LC](#) [DTS24F19-](#)
[11SC-3028-LC](#) [DTS24F19-11SC-3028](#) [DJT14E13-98HB](#) [D38999/20WC8BB](#) [1-330599-5](#) [DTS24F21-41HN-LC](#) [DTS24F21-41HN](#)
[DTS24F21-41AN](#) [DTS24F21-39HN](#) [DTS24F21-41PN-LC](#) [AFD50-10-6SN-1A-LC](#) [DJT10F17-26HC](#) [DTS24W19-32HB](#) [ACT20JE99HA](#)
[DJT10E17-26HC](#) [DJT10E17-26HN](#) [DJT10F17-26HA](#)