

## 1110 KSS Circuit Board Track

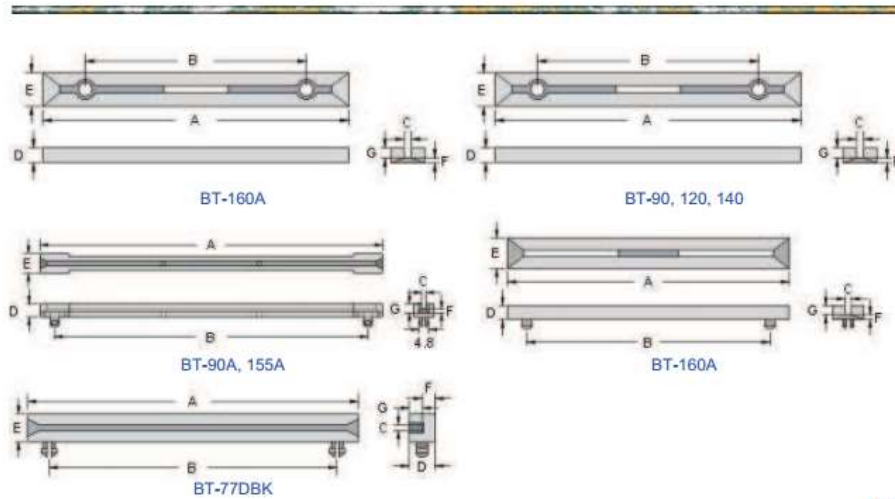

- Material: UL approved Nylon 66, 94V-2.
- Color: Natural, available in other colors.
- To be fixed by 2 sets of 3mm flat-head screw.
- ★ BT-90A,BT-155A,BT-160A with snap in design.



Unit: mm

Item No.	A	B	C	D	E	F	G	Packing
BT-90A	89.5	77.5	2.0	4.5	9.7	1.5	3.0	100 pcs / Bag
BT-90	89.5	64.4	2.0	4.5	9.7	1.5	3.0	
BT-120	119.0	94.5	2.0	4.5	9.5	1.5	3.0	
BT-140	142.0	116.4	2.0	4.5	9.7	1.5	3.0	
BT-155A	154.0	141.0	2.0	4.6	6.5	1.3	3.3	
BT-160	160.5	134.5	2.0	4.5	9.7	1.5	3.0	
BT-160A	163.0	149.5	2.0	6.5	9.5	4.0	2.5	
BT-77DBK	77.0	67.0	1.4	6.0	6.6	1.5	3.0	

## X-ON Electronics

Largest Supplier of Electrical and Electronic Components

*Click to view similar products for [Electrical Enclosure Accessories](#) category:*

*Click to view products by [KSS](#) manufacturer:*

Other Similar products are found below :

[60121-06-028 C-325 Black](#) [71884-04-028 CM3-100 Black](#) [71884-18-028 LH43-200 Black](#) [71884-24-028 LH75-200 Black](#) [71885-01-028 CM6-150 Black](#) [72459-02-028 DM-3 BLACK](#) [81501-01-000 XPL, 9VB Black](#) [82402-01 PT-8 ALUM](#) [1335GSKT3](#) [14101FP-PK](#) [CB-1263-BT](#) [1611512-4](#) [HB-11498](#) [RC-7775](#) [HM BLACK PANEL](#) [61033-01-000](#) [115123-01-508 CN-RL RS](#) [115124-01-508 CN-XRL XRS](#) [115119-01-000 CN-RL RS](#) [115123-01-000 CN-RL RS](#) [60121-04-028 C-275 Black](#) [60128-01-072](#) [60222-01-028 CM6-225 Black](#) [60272-01-028 CM3-150 Black](#) [60851-01-028 CM69-120 Black](#) [62291-502-000-KEU-10-BLK](#) [62452-01-000 HML-9VB, EB Black](#) [71884-25-028 LH89-130 Black](#) [AXX2POSTBRCKT](#) [FUPMESK](#) [71884-23-028 LH75-130 Black](#) [1317GSKTSC](#) [8G813V40389](#) [DVA.1-10-15-M4-10-70](#) [DVC.1-60-49-60-M10-28-55](#) [DVC.1-15-8,5-15-M4-10-40](#) [DVC.1-20-12-30-M6-18-40](#) [DVC.1-30-18-25-M8-20-40](#) [DVC.1-35-31-15-M8-20-40](#) [DVC.1-35-31-15-M8-20-70](#) [DVC.1-75-60-40-M12-37-70](#) [DVC.2-30-22-20-M8-20-55](#) [DVC.2-40-30-25-M8-23-55](#) [DVC.2-75-60-40-M12-37-55](#) [DVC.2-21-16-22-M6-18-40](#) [DVC.2-40-20-48-M8-23-40](#) [DVC.2-40-32-50-M8-23-40](#) [DVC.2-20-14-19-M6-18-70](#) [DVC.2-25-18-20-M6-18-70](#) [DVC.3-20-14-20-M6-40](#) [DVC.3-20-14-30-M6-40](#)