

Bridgelux RS Array Series

Product Data Sheet DS15

Introduction

The Bridgelux family of LED Array products delivers high performance, compact and cost-effective solid-state lighting solutions to serve the general lighting market. These products combine the higher efficacy, lifetime, and reliability benefits of LEDs with the light output levels of many conventional lighting sources. The Bridgelux RS Array Series has been specified to enable lamp and luminaire designs with comparable performance to existing high wattage CFL and HID conventional light sources for retail, commercial, industrial and street lighting applications.

The Bridgelux RS Array series provides a high performance alternative to conventional solid state solutions, delivering between 3000 and 4500 lumens under application conditions in warm and cool white color temperatures. These compact high flux density light sources deliver uniform high quality illumination without pixilation or the multiple shadow effect caused by LED component based solutions, enabling excellent beam control for precision lighting. To simplify system design for appropriate light output, Bridgelux LED Arrays are specified to deliver performance under typical use conditions.

These integrated plug and play solutions reduce system complexity and enable miniaturized cost-effective lamp and luminaire designs. Lighting system designs incorporating these LED Arrays deliver performance comparable to that of a 2x26 Watt CFL, 42-55 Watt CFL, 35-55 Watt low pressure sodium, 70-Watt high pressure sodium or 70-100 Watt metal halide based luminaires and feature increased system level efficacy and service life. Typical applications include retail lighting, commercial down lights, high bay, street lights, bollards, wide area, and entertainment lighting.

Features

- Compact high flux density light source
- Uniform high quality illumination
- Streamlined thermal path
- Energy Star / ANSI compliant binning structure
- More energy efficient than incandescent, halogen and fluorescent lamps
- Low voltage DC operation
- Instant light with unlimited dimming
- Long operating life
- RoHS compliant and Pb free

Benefits

- Enhanced optical control
- Clean white light without pixilation
- Significantly reduced thermal resistance and increased operating temperatures
- Uniform consistent white light
- Lower operating costs
- Increased safety
- Easy to use with daylight and motion detectors to enable increased energy savings
- Reduced maintenance costs
- Environmentally friendly, no disposal issue



Table of Contents	Page
Product Nomenclature	3
Average Lumen Maintenance Characteristics	3
Environmental Compliance	3
UL Recognition	4
Minor Product Change Policy	4
Cautionary Statements	4
Case Temperature Measurement Point	5
Flux Characteristics	6
Optical Characteristics	7
Electrical Characteristics	8
Absolute Minimum and Maximum Ratings	9
Typical Performance at Alternative Drive Currents	10
Mechanical Dimensions	11
Typical Radiation Pattern	12
Wavelength Characteristics	13
Typical Relative Luminous Flux vs. Current	14
Typical Light Output Characteristics vs. Temperature	15
Typical Chromaticity Characteristics vs. Temperature	16
Typical Forward Current Characteristics	17
Current Derating Curves	18
Product Binning	19
Luminous Flux Binning Information	19
Color Binning Information	20
Mechanical Assembly and Handling	22
Product Packaging and Labeling	24
Packaging Tube Design	27
Design Resources	28

Product Nomenclature

The part number designation for Bridgelux LED Arrays is explained as follows:

B X R A – A B C D E – R R R R R

Where:

B X R A – designates product family

A – designates color, C for Cool White and W for Warm White

B C D – designates LED Array product flux, 300 for a 3000 lumen array and 450 for a 4500 lumen array

E – designates product family

R R R R R – used to designate product options, 00000 by default

The base product part number (BXRA-ABCDE) is indicated on each individual unit, printed on the bottom of the LED Array.

Average Lumen Maintenance Characteristics

Bridgelux projects that its family of LED Array products will deliver, on average, greater than 70% lumen maintenance after 50,000 hours of operation at the rated forward test current. This performance assumes constant current operation with case temperature maintained at or below 70°C. For use beyond these typical operating conditions please consult your Bridgelux sales representative for further assistance.

These projections are based on a combination of package test data, semiconductor chip reliability data, a fundamental understanding of package related degradation mechanisms, and performance observed from products installed in the field using Bridgelux die technology. Bridgelux conducts lumen maintenance tests per LM80. Observation of design limits is required in order to achieve this projected lumen maintenance.

Environmental Compliance

Bridgelux is committed to providing environmentally friendly products to the solid-state lighting market. Bridgelux LED Arrays are compliant to the European Union directives on the restriction of hazardous substances in electronic equipment, namely the RoHS directive. Bridgelux will not intentionally add the following restricted materials to LED Array products: lead, mercury, cadmium, hexavalent chromium, polybrominated biphenyls (PBB) or polybrominated diphenyl ethers (PBDE).

UL Recognition

Bridgelux is in the process of securing UL Recognition for the LED Array products. This process is expected to be complete in February 2010. Bridgelux uses UL Recognized materials with suitable flammability ratings in the LED Array to streamline the process for customers to secure UL listing of the final luminaire product. Bridgelux recommends that luminaires are designed with a Class 2 Driver to facilitate the UL listing process.

Minor Product Change Policy

The rigorous qualification testing on products offered by Bridgelux provides performance assurance. Slight cosmetic changes that do not affect form, fit, or function may occur as Bridgelux continues product optimization.

CAUTION: CONTACT WITH OPTICAL AREA

Contact with the resin area should be avoided. Applying stress to the resin area can result in damage to the product.

CAUTION: EYE SAFETY

Eye safety classification for the use of Bridgelux LED Arrays is in accordance with IEC specification EN62471; Photobiological Safety of Lamps and Lamp Systems. Bridgelux LED Arrays are classified as Risk Group 1 (Low Risk) when operated at or below their rated test current. Please use appropriate precautions. It is important that employees working with LEDs are trained to use them safely.

CAUTION: RISK OF BURN

Do not touch the LED Array or resin area during operation. Allow the LED Array to cool for a sufficient period of time before handling. The LED Array may reach elevated temperatures such that it can burn skin when touched.

Case Temperature Measurement Point

A case temperature measurement point location is included on the top surface of the Bridgelux LED Arrays. The location of this measurement point is indicated in the mechanical dimensions section of this data sheet.

The purpose of this measurement point is to allow the user access to a measurement point closely linked to the true case temperature on the back surface of the LED Array. Once the LED Array is installed, it is challenging to measure the back surface of the array, or true case temperature. Measuring the top surface of the product can lead to inaccurate results due to the poor thermal conductivity of the top layers of the array such as the solder mask and other materials.

Bridgelux has provided the case temperature measurement location in a manner which closely ties it to the true case temperature of the LED Array under steady state operation. Deviations between thermal measurements taken at the point indicated and the back of the LED Array differ by less than 1°C, providing a robust method to testing thermal operation once the product is installed.

Flux Characteristics

Table 1: Flux Characteristics

Color	Base Part Number	Typical Luminous Flux ϕ_v (lm), $T_{case}=60^{\circ}C$ [3]	Minimum Luminous Flux ϕ_v (lm), $T_j=25^{\circ}C$ [1]	Typical Luminous Flux ϕ_v (lm), $T_j=25^{\circ}C$	Test Current (mA) [2]
Warm White	BXRA-W3000	3100	3000	3400	2100
Cool White	BXRA-C4500	4500	4500	5000	2100

Notes for Table 1:

1. Bridgelux maintains a $\pm 7\%$ tolerance of flux measurements.
2. Parts are tested in pulsed conditions, $T_j = 25^{\circ}C$. Pulse width is 10 ms at rated test current.
3. Typical performance when driven with direct current using Bridgelux test set-up. Please contact a Bridgelux sales representative for additional details

Optical Characteristics

Table 2: Optical Characteristics

Color	Base Part Number	Color Temperature (CCT) ^{[1],[2],[3]}			Typical Color Rendering Index ^[4]	Typical Viewing Angle (Degrees) $2\theta_{\frac{1}{2}}$ ^[6]	Typical Center Beam Candle Power (cd) ^[5]
		Min	Typ	Max			
Warm White	BXRA-W3000	2580 K	3000 K	3700 K	82	120	1200
Cool White	BXRA-C4500	4750 K	5600 K	7000 K	65	120	1430

Notes for Table 2:

1. Parts are tested in pulsed conditions, $T_j = 25^\circ\text{C}$. Pulse width is 10 ms at rated test current.
2. Refer to Flux Characteristic Table for test current data.
3. Product is binned for color in x y coordinates.
4. Higher CRI options available upon request.
5. Center beam candle power is a calculated value based on lambertian radiation pattern at nominal test current.
6. Viewing angle is the off axis angle from the centerline where I_v is $\frac{1}{2}$ of the peak value.

Electrical Characteristics

Table 3: Electrical Characteristics

Color	Base Part Number	Forward Voltage V_f (V) ^[1]			Test Current (mA) ^[2]	Typical Temperature Coefficient of Forward Voltage (mV/°C) $\Delta V_f / \Delta T_j$	Typical Thermal Resistance Junction to Case (°C/W) $R\theta_{j-c}$
		Min	Typ	Max			
Warm White	BXRA-W3000	23.4	25.4	27.4	2100	-8 to -24	0.2
Cool White	BXRA-C4500	23.4	25.4	27.4	2100	-8 to -24	0.2

Notes for Table 3:

1. Parts are tested in pulsed conditions, $T_j = 25^\circ\text{C}$. Pulse width is 10 ms at rated test current.
2. Bridgelux maintains a tester tolerance of ± 0.10 V on forward voltage measurements.

Absolute Minimum and Maximum Ratings

Table 4: Minimum and Maximum Current and Reverse Voltage Ratings

Part Number	Maximum DC Forward Current (mA)	Minimum DC Forward Current (mA) ^[2]	Maximum Peak Pulsed Current (mA) ^[3]	Maximum Reverse Voltage (Vr) ^[1]
BXRA-W3000	3000	1200	4000	-40 Volts
BXRA-C4500	3000	1200	4000	-40 Volts

Table 5: Maximum Ratings

Parameter	Maximum Rating
LED Junction Temperature	150°C
Storage Temperature	-40°C to +105°C
Operating Case Temperature	105°C
Soldering Temperature	3.5 seconds, 350°C or lower

Notes for Table 4:

1. Light emitting diodes are not designed to be driven in reverse voltage.
2. Driving these high current devices at low currents can result in variations in performance. For low current operation pulse width modulation is recommended.
3. Bridgelux recommends a maximum duty cycle of 10% when operating LED Arrays at the maximum peak pulsed current specified.

Typical Performance at Alternative Drive Currents

The Bridgelux LED Arrays are tested and binned against the specifications shown in Tables 1, 2 and 3. Customers also have options to drive the LED Arrays at alternative drive currents dependent on the specific application. The typical performance at any drive current can be derived from the flux vs. current characteristics shown in Figure 6 and from the current vs. voltage characteristics shown in Figure 10. The typical performance at common drive currents is also summarized in Table 6.

Table 6: Typical Product Performance at Alternative Drive Currents

Color	Part Number	Typical Luminous Flux ϕ_v (lm), $T_{case}=60^{\circ}C$	Typical Luminous Flux ϕ_v (lm), $T_j=25^{\circ}C$	Typical Forward Voltage V_f (V)	Forward Current (mA) ^[2]
Warm White	BXRA-W3000	2150	2400	24.6	1400
		2650	2950	25.1	1750
		3100	3400	25.4	2100 ^[1]
Cool White	BXRA-C4500	3150	3500	24.6	1400
		3800	4250	25.1	1750
		4500	5000	25.4	2100 ^[1]

Notes for Table 6:

1. Product is tested and binned at the specified drive current.
2. Operating these LED Arrays at or below the drive currents listed in Table 6, with a case temperature maintained at or below 70°C, will enable the average lumen maintenance projection outlined earlier in this Product Data Sheet.

Mechanical Dimensions

Figure 1: Drawing for part numbers BXRA-W3000 and BXRA-C4500.

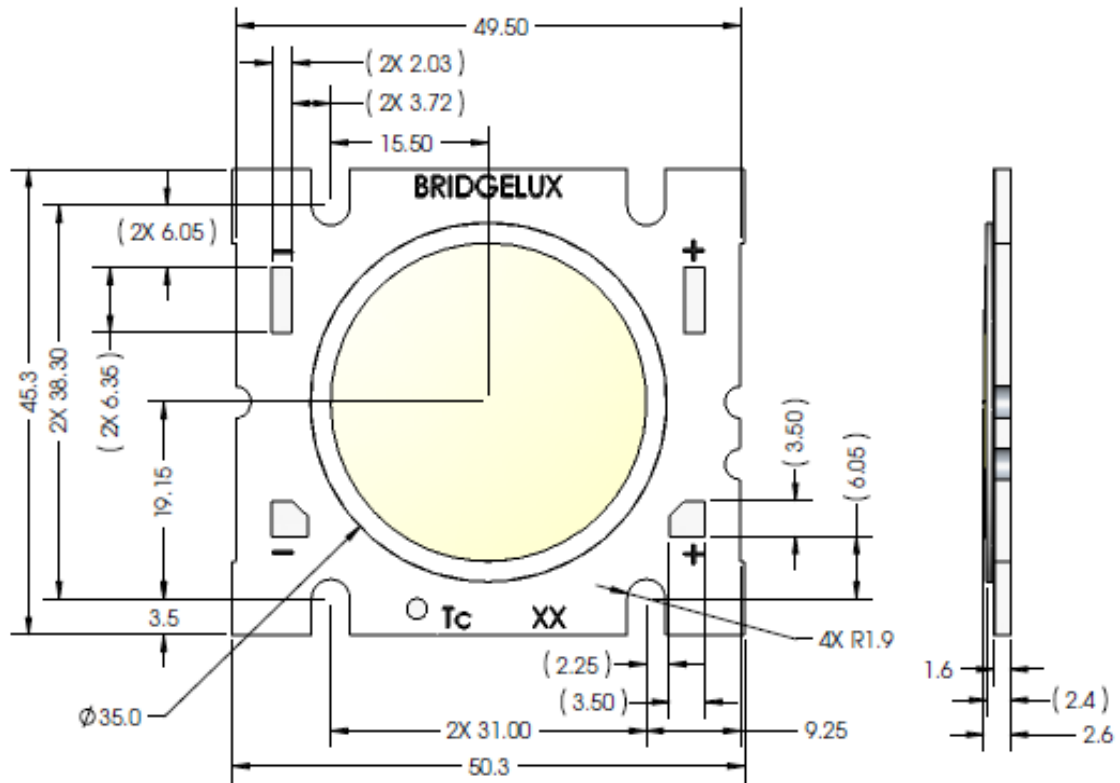

Notes for Figure 1:

1. Slots are for M2.5, M3 or #4 screws.
2. Solder pads are labeled "+" and "-" to denote positive and negative, respectively.
3. It is not necessary to provide electrical connections to both sets of solder pads. Either set of solder pads (6.35 x 2.03 mm rectangular pads or 3.50 mm tapered square pads) may be used depending on application specific design requirements.
4. Drawings are not to scale.
5. Drawing dimensions are in millimeters.
6. Bridgelux recommends four tapped holes for mounting screws – refer to figure 15 (Mechanical Assembly and Handling) for recommended spacing of holes.
7. Unless otherwise specified, tolerances are ± 0.10 mm.
8. Dimensions with REF are for reference only.
9. Refer to product Application Notes AN10 and AN11 for product handling, mounting and heat sink recommendations.
10. The optical center of the LED Array is defined by the mechanical center of the array.

Typical Radiation Pattern

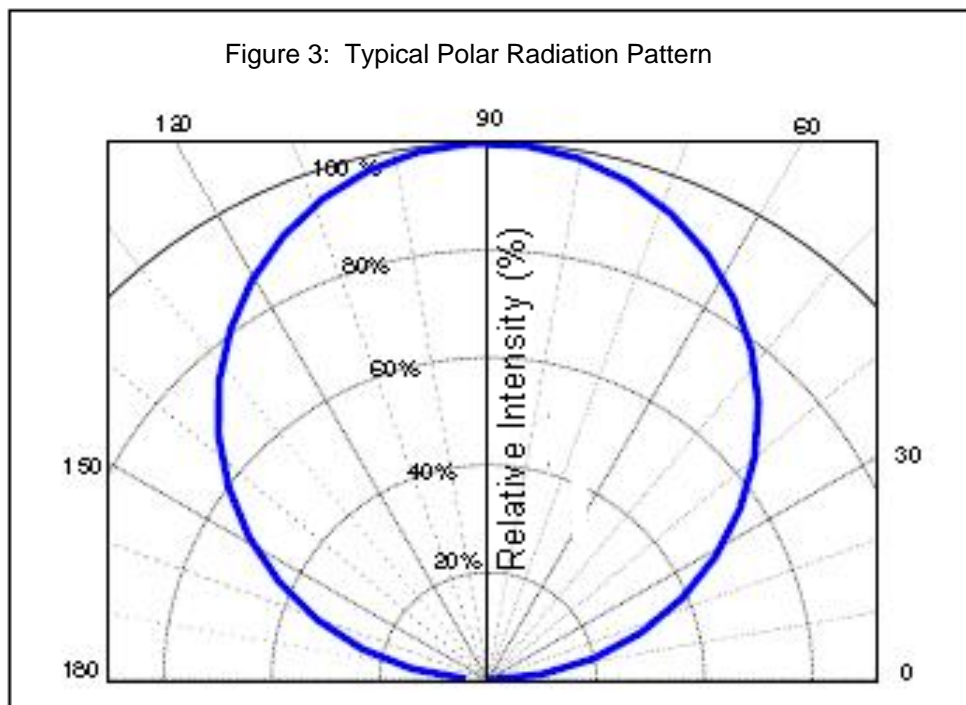
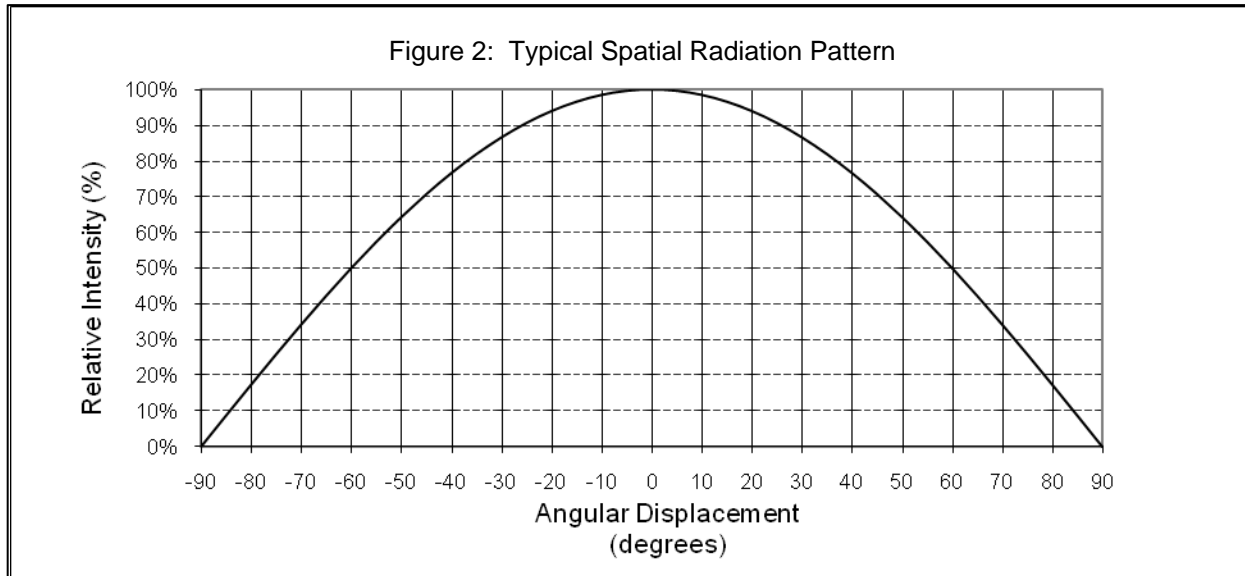

Wavelength Characteristics at Rated Test Current, $T_j=25^{\circ}\text{C}$

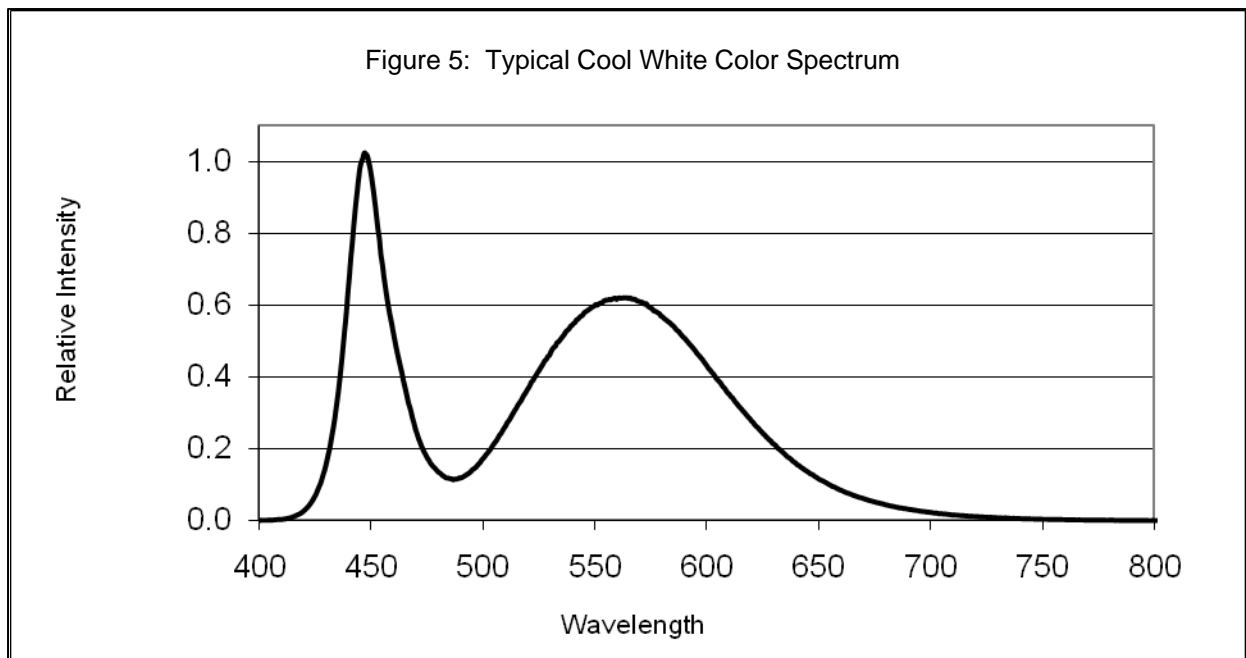
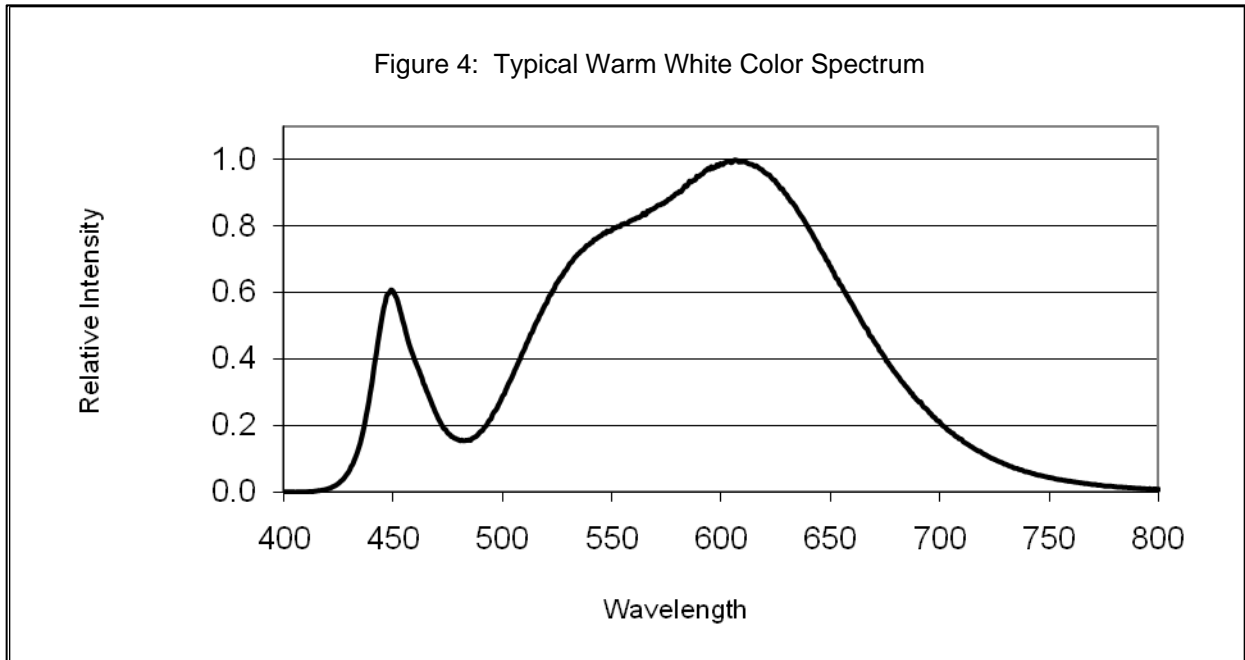

Typical Relative Luminous Flux vs. Current, $T_j=25^\circ\text{C}$

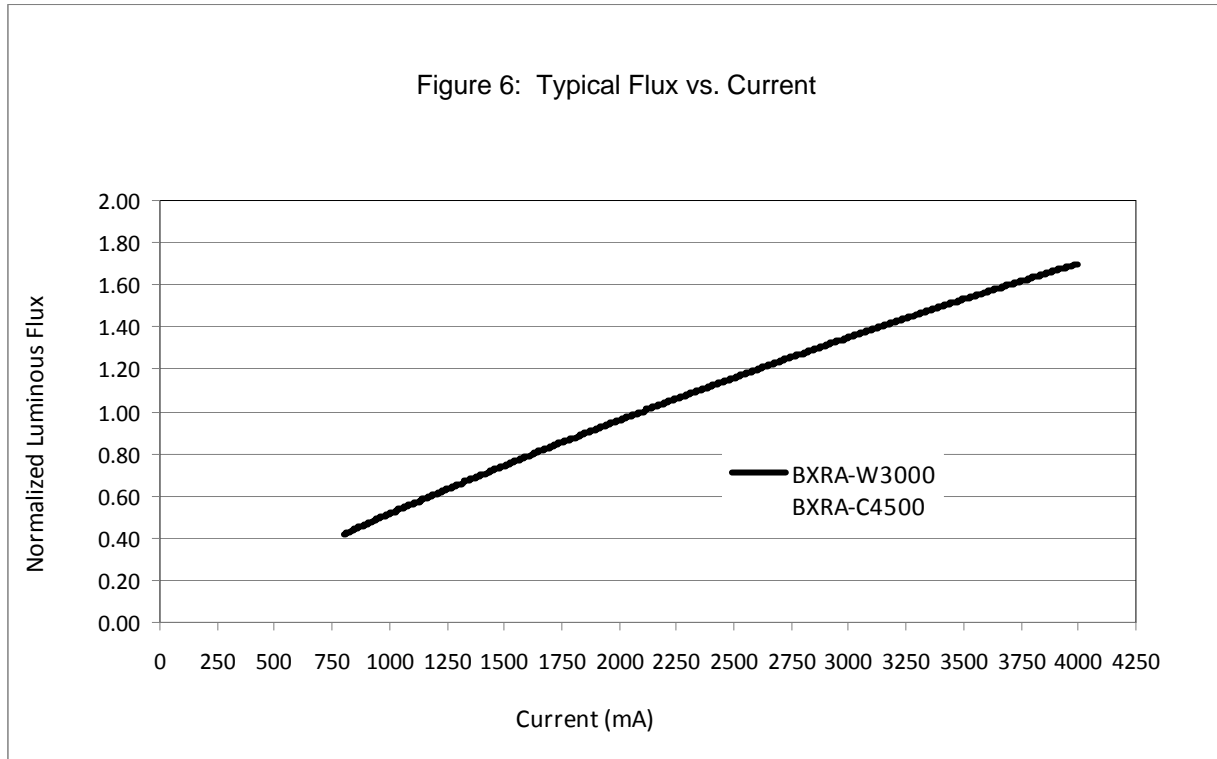

Note for Figure 6: Bridgelux does not recommend driving high power LED Arrays at low currents. Doing so may produce unpredictable results. Pulse width modulation (PWM) is recommended for dimming effects.

Typical Light Output Characteristics vs. Temperature

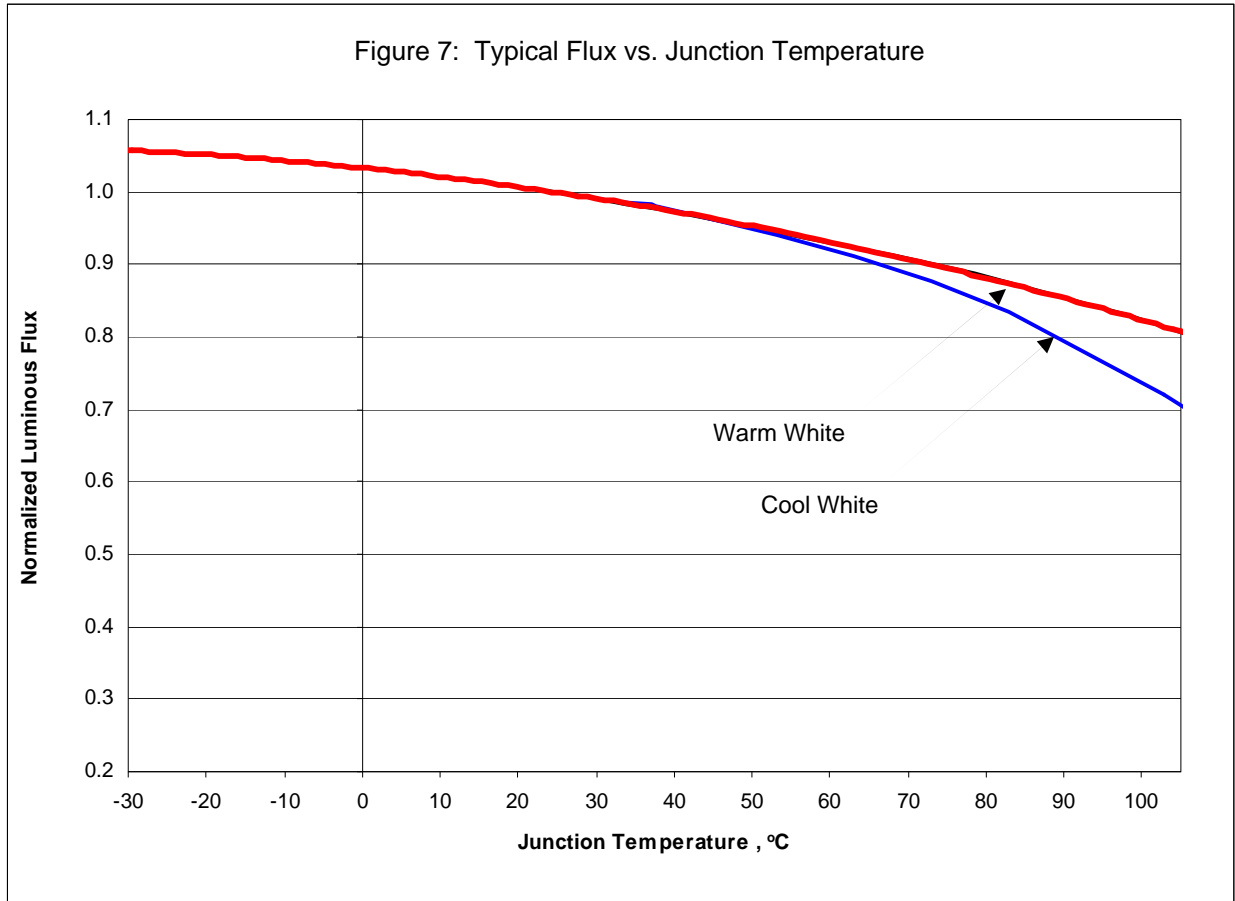

Typical Chromaticity Characteristics vs. Temperature

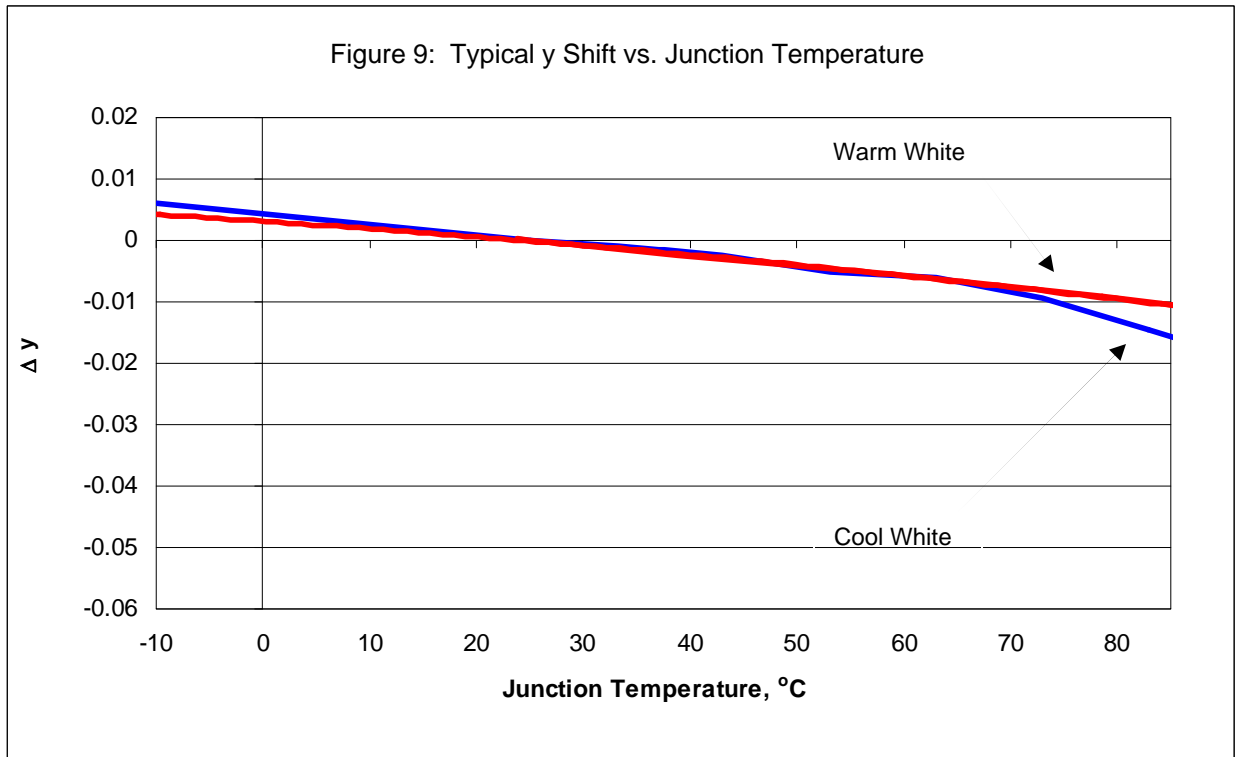
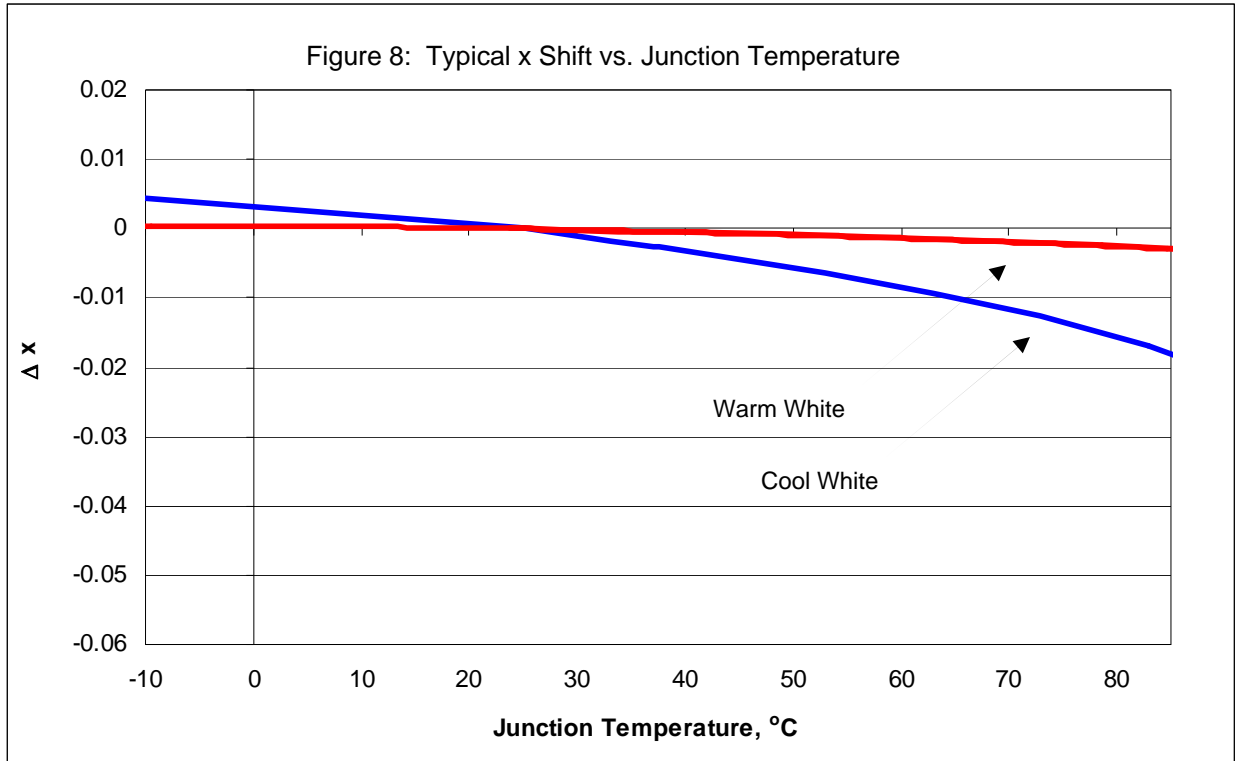

Typical Forward Current Characteristics at $T_j = 25^\circ\text{C}$

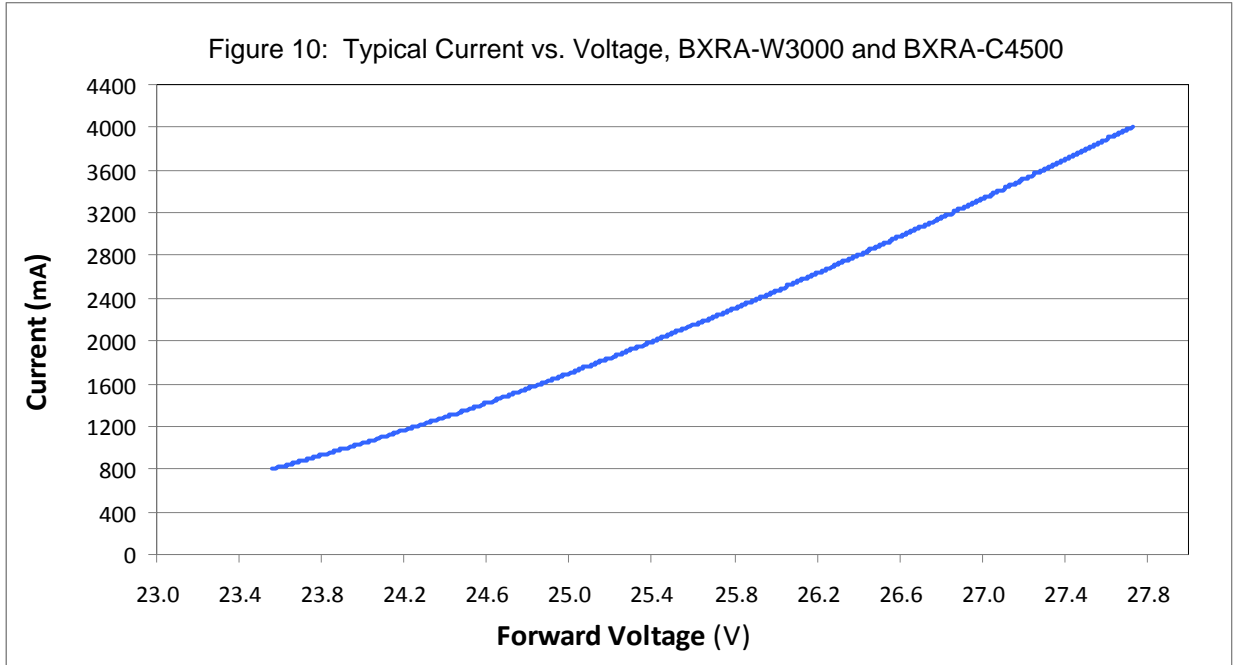

Current Derating Curves

The graph below illustrates the relationship between the system thermal resistance, drive current, and ambient temperature. Please note that absolute maximum ratings requirements, including that of maximum case temperature, must be adhered to in the system design. The thermal resistance values indicated in Figure 11 are total system values (junction to ambient) including the thermal resistance of the LED Array. Individual LED Array thermal resistance values are listed in Table 3.

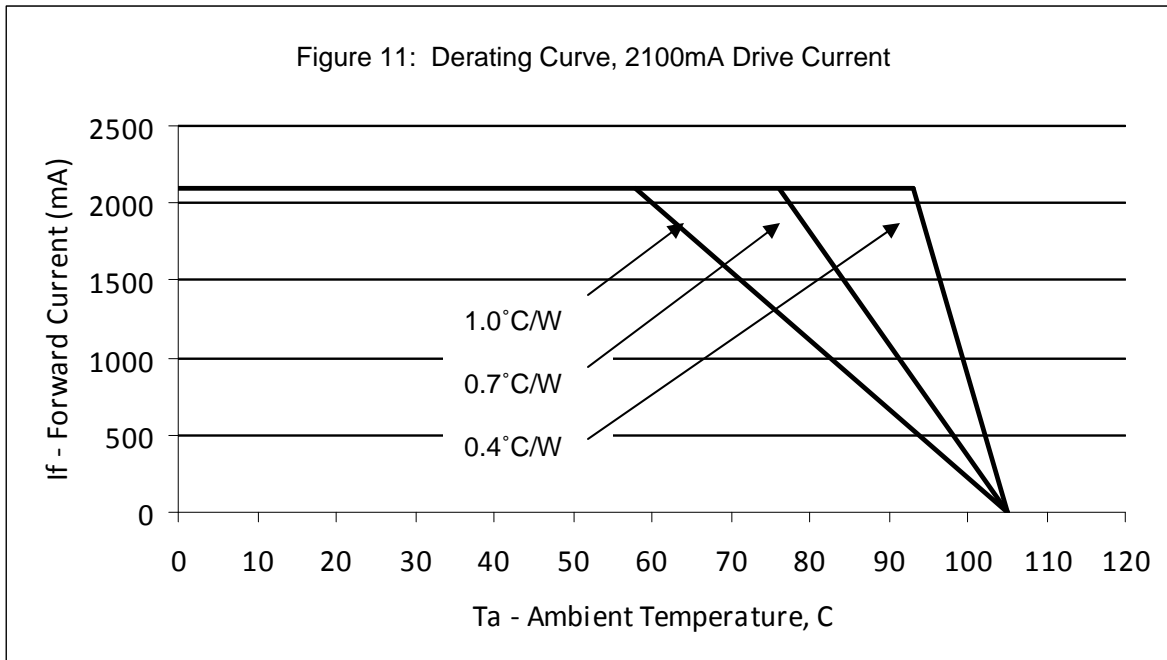

Product Binning

Typical manufacturing processes of semiconductor products result in a variation in performance surrounding the typical data sheet values. In order to minimize variation in the end product or application, Bridgelux bins its LED Arrays for luminous flux and color.

Bridgelux LED Arrays are labeled using a 4-digit alphanumeric bin code. This bin code is printed on the back of each LED Array in the following format:

A B C D

Where:

- A – designates flux bin (P, Q, R etc.)
- B C – designates color bin (P3, P4, Q3, etc.)
- D – reserved for future product designations.

All product packaged within a single tube are of the same flux and color bin combination (or bin code). Using these codes it is possible to determine the best product utilization to deliver the consistency required in a given application.

Luminous Flux Binning Information

The table below lists the standard photometric luminous flux bins for Bridgelux LED Arrays (tested and binned at the indicated test current). Although several bins are outlined, product availability in a particular bin varies by product and production run. Please contact your Bridgelux sales representative for further information regarding product availability. All production testing and binning (both flux and color binning) is conducted under pulsed test conditions at $T_j = 25^\circ\text{C}$.

Table 7: Luminous Flux Bins

Bin Code	Min	Max
D	2700 lm	3000 lm
E	3000 lm	3400 lm
F	3400 lm	3800 lm
G	3800 lm	4200 lm
H	4200 lm	4500 lm
J	4500 lm	5000 lm
K	5500 lm	5500 lm
L	5500 lm	6000 lm
M	6000 lm	6600 lm

Color Binning Information

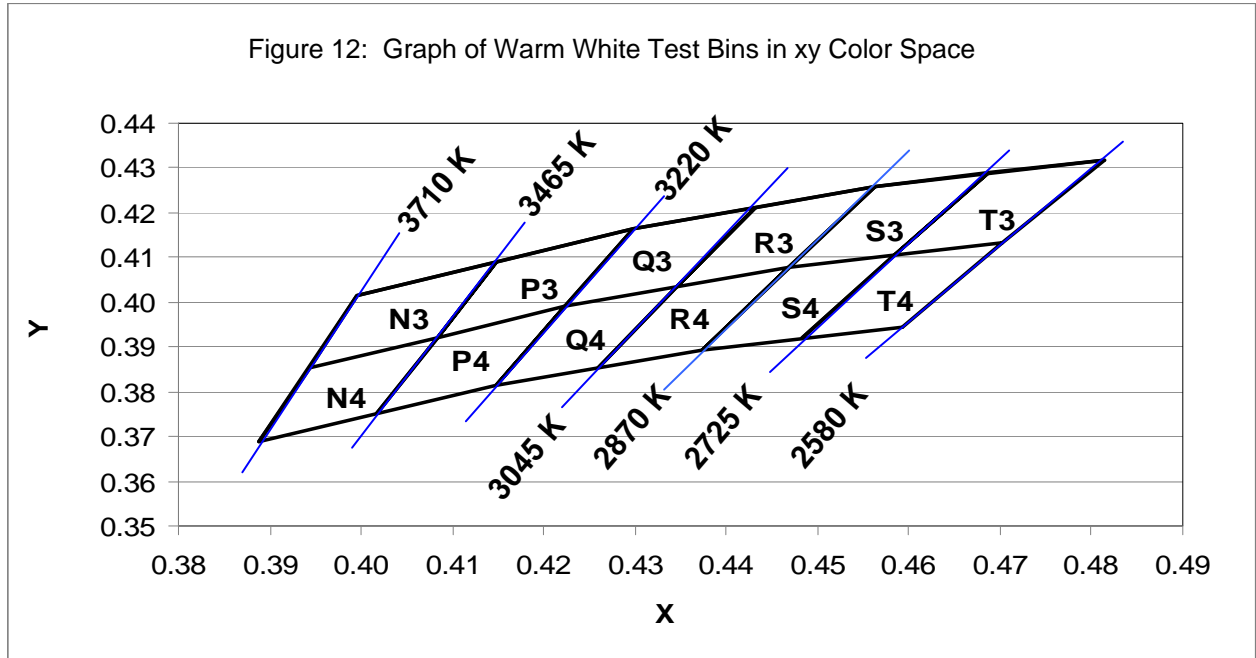

Table 8: Warm White xy Bin Coordinates and Associated Typical CCT

Bin Code	X	Y	ANSI CCT (K)	Bin Code	X	Y	ANSI CCT (K)	Bin Code	X	Y	ANSI CCT (K)
N3	0.3943	0.3853	3500	Q3	0.4223	0.3990	3000	S3	0.4468	0.4077	2700
	0.3996	0.4015			0.4299	0.4165			0.4562	0.4260	
	0.4148	0.4090			0.4431	0.4213			0.4688	0.4290	
	0.4083	0.3921			0.4345	0.4033			0.4578	0.4104	
N4	0.3889	0.3690	3500	Q4	0.4147	0.3814	3000	S4	0.4373	0.3893	2700
	0.3943	0.3853			0.4223	0.3990			0.4468	0.4077	
	0.4083	0.3921			0.4345	0.4033			0.4578	0.4104	
	0.4018	0.3752			0.4260	0.3854			0.4483	0.3919	
P3	0.4083	0.3921	3500	R3	0.4345	0.4033	3000	T3	0.4578	0.4104	2700
	0.4148	0.4090			0.4431	0.4213			0.4688	0.4290	
	0.4299	0.4165			0.4562	0.4260			0.4813	0.4319	
	0.4223	0.3990			0.4468	0.4077			0.4703	0.4132	
P4	0.4018	0.3752	3500	R4	0.4260	0.3854	3000	T4	0.4483	0.3919	2700
	0.4083	0.3921			0.4345	0.4033			0.4578	0.4104	
	0.4223	0.3990			0.4468	0.4077			0.4703	0.4132	
	0.4147	0.3814			0.4373	0.3893			0.4593	0.3944	

Color Binning Information (continued)

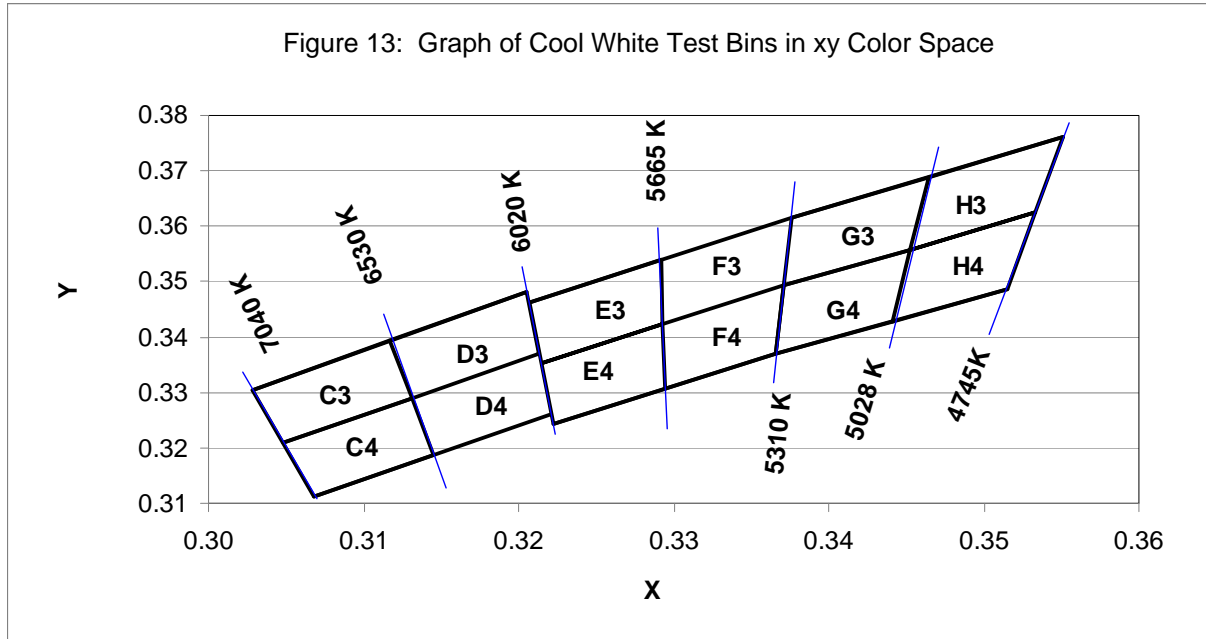

Table 9: Cool White xy Bin Coordinates and Associated Typical CCT

Bin Code	X	Y	ANSI CCT (K)	Bin Code	X	Y	ANSI CCT (K)	Bin Code	X	Y	ANSI CCT (K)
C3	0.3048	0.3209	6500	E3	0.3215	0.3353	5700	G3	0.3376	0.3616	5000
	0.3131	0.3290			0.3293	0.3423			0.3464	0.3688	
	0.3117	0.3393			0.3292	0.3539			0.3452	0.3558	
	0.3028	0.3304			0.3207	0.3462			0.3371	0.3493	
C4	0.3068	0.3113	6500	E4	0.3222	0.3243	5700	G4	0.3371	0.3493	5000
	0.3145	0.3187			0.3294	0.3306			0.3452	0.3558	
	0.3131	0.3290			0.3293	0.3423			0.3441	0.3428	
	0.3048	0.3209			0.3215	0.3353			0.3366	0.3369	
D3	0.3131	0.3290	6500	F3	0.3292	0.3539	5700	H3	0.3464	0.3688	5000
	0.3213	0.3371			0.3293	0.3423			0.3551	0.3760	
	0.3205	0.3481			0.3371	0.3493			0.3533	0.3624	
	0.3117	0.3393			0.3376	0.3616			0.3452	0.3558	
D4	0.3145	0.3187	6500	F4	0.3294	0.3306	5700	H4	0.3452	0.3558	5000
	0.3221	0.3261			0.3366	0.3369			0.3533	0.3624	
	0.3213	0.3371			0.3371	0.3493			0.3515	0.3487	
	0.3131	0.3290			0.3293	0.3423			0.3441	0.3428	

Mechanical Assembly and Handling

Recommended assembly is illustrated below.

When handling parts, please avoid contacting and do not apply stress to the resin area (see Figure 1, resin area is indicated in yellow).

Product should be firmly secured onto appropriate heat sink by fastening M2.5, M3 or #4 screws on both sides of the product as illustrated in Figure 14. To ensure proper thermal contact it is important to mount the LED Array to the heat sink using 4 mounting screws. Bridgelux recommends the use of hard non-electrically conductive flat washers with lock washers. The recommended center to center spacing for the four tapped holes for mounting the Bridgelux RS Series Array is shown in Figure 15. Refer to Application Note AN11 – Handling and Assembly of Bridgelux LED Arrays, for more details.

A thin layer of thermal grease should be applied to the bottom surface of the LED Array, between the bottom of the LED Array and the heat sink. All air gaps and voids between the heat sink and array should be eliminated. Ensure that sufficient thermal grease is used to cover the entire bottom surface of the array, but not so much that the thermal grease creeps up to the top of the array.

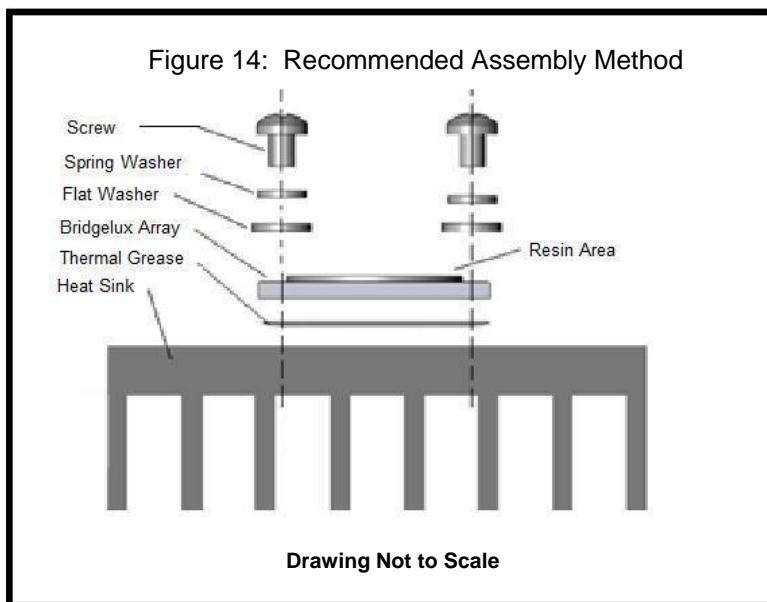

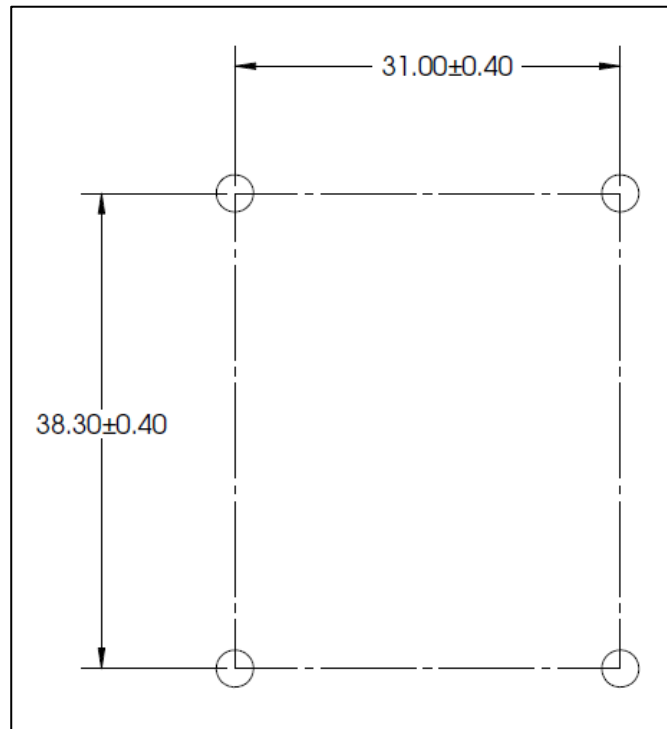

Figure 15: Recommended Center to Center Spacing for Tapped Mounting Holes

Notes for Figure 15:

1. Drawing dimensions are in millimeters.

Product Packaging and Labeling

All Bridgelux LED Array products are 100% tested, binned and labeled. Products are labeled by printing pertinent information on the back side of the LED Array.

The following format is used for labeling the Bridgelux LED Arrays:

A B C D
B X R A – x x x x x
E F G H J – W W Y Y

Where:

A B C D – designates the bin code (EQ30, etc.)

x x x x x – designates the base part number (W3000, etc.)

E F G H J – designates the production lot code (12345, etc.)

W W Y Y – designates the date code (production week and production year, 0210, etc.)

Individual Bridgelux LED Arrays are packaged in tubes for shipment. All product packaged within a single tube are of the same flux and color bin combination (or bin code). Each tube is labeled with the information required for effective inventory management. An example of the tube label is shown in Figure 16.



Figure 16: Tube Label Example

Where:

X X X X X – designates the base part number (W3000, etc.)

A B C D – designates the bin code (EQ30, etc.)

E F G H J – designates the production lot code (12345, etc.)

W W Y Y – designates the date code (production week and production year, 0210, etc.)

Z Z – designates the quantity (10 products per tube).

Product Packaging and Labeling (continued)

Tubes of Bridgelux LED Arrays are packaged in bags prior to loading into boxes for shipment. One tube is loaded per bag, resulting in an SPI of 10. All products packaged within a single bag are of the same flux and color bin combination (or bin code). Each bag is labeled with the information required for effective inventory management. An example of the bag label is shown in Figure 17.

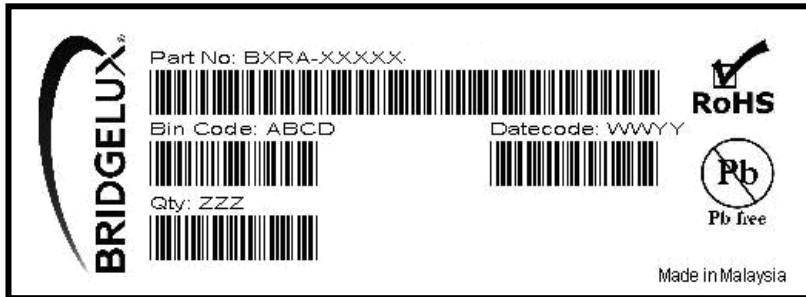

Figure 17: Bag Label Example

Where:

X X X X X – designates the base part number (W3000, etc.)

A B C D – designates the bin code (EQ30, etc.)

W W Y Y – designates the date code (production week and production year, 0210, etc.)

Z Z Z – designates the quantity (10 products per tube).

Bags of Bridgelux LED Arrays are packaged in boxes prior to shipment. Multiple bags are packaged into a box. All products packaged within a box are of the same base part number. Each box is labeled with the information required for effective inventory management. An example of the box label shown in Figure 18.

Product Packaging and Labeling (continued)



Figure 18: Box Label Example

Where:

- X X X X X – designates the base part number (W3000, etc.)
- R R R R R – used to designate product options, 00000 by default.
- Q Q Q – designates the total quantity of LED Arrays contained in the box.
- S S S S S – designates product lot code.
- A B C D – designates the bin code (EQ30, etc.)
- W W Y Y – designates the date code (production week and production year, 0210, etc.)
- Z Z Z – designates the quantity per listed bin code contained in the box.

Packaging Tube Design

Figure 19: Tube Design

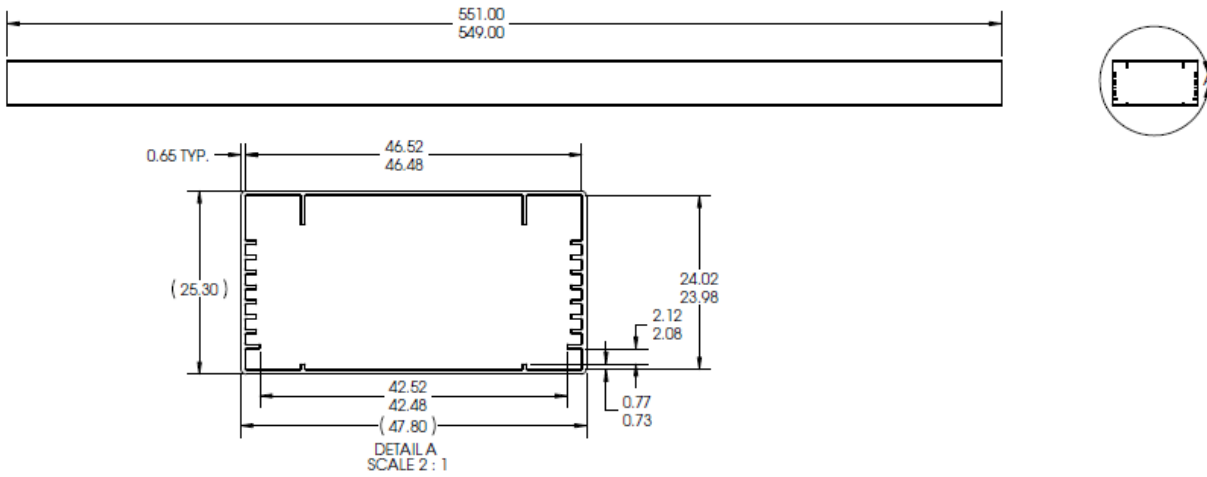

Notes for Figures 19:

1. Drawings are not to scale.
2. Drawing dimensions are in millimeters.

Design Resources

Bridgelux has developed a comprehensive set of application notes and design resources to assist customers in successfully designing with Bridgelux LED Array products. Included below is a list of available resources which can be downloaded from the Bridgelux web site under the Design Resources section. These documents are updated regularly as new information becomes available, including complimentary infrastructure products such as commercially available secondary optics and electronic driver solutions.

Application Notes

- AN10: Effective Thermal Management of Bridgelux LED Arrays
- AN11: Assembly Considerations for Bridgelux LED Arrays
- AN12: Electrical Drive Considerations for Bridgelux LED Arrays
- AN14: Reliability Data Sheet for Bridgelux LED Arrays
- AN15: Reflow Soldering of Bridgelux LED Arrays
- AN16: Optical Considerations for Bridgelux LED Arrays

Optical Source Models

Optical source models and ray set files are available for all Bridgelux LED Array products, and can be downloaded directly from the Bridgelux web site. The list below contains the formats currently available. If you require a specific format not included in this list, please contact your Bridgelux sales representative for assistance.

- Zemax
- ASAP
- IESNA
- LightTools
- LucidShape
- OPTIS SPEOS
- PHOTOPIA
- TracePro
- Radiant Imaging Source Model

3D CAD Models

Three dimensional CAD models depicting the product outline of all Bridgelux LED Arrays are available in both SAT and STEP formats. These CAD files can be downloaded directly from the Bridgelux web site.

About Bridgelux

Bridgelux LED Arrays are developed, manufactured and marketed by Bridgelux, Inc. Bridgelux is a U.S. lighting company and leading developer of technologies and solutions that will transform the \$40 billion global lighting industry into a \$100 billion market opportunity. Based in Silicon Valley, Bridgelux is a pioneer in solid-state lighting (SSL), expanding the market for solid state lighting by driving down the cost of light through innovation. Bridgelux's patented light source technology replaces traditional lighting technologies (such as incandescent, halogen and fluorescent lamps) with integrated, solid-state solutions, enabling lamp and luminaire manufacturers to develop high performance and energy-efficient white light products. The plug and play simplicity of the Bridgelux LED Arrays enable our customers to address the rapidly growing interior and exterior solid state lighting markets, including street lights, retail lighting, commercial lighting and consumer applications. With more than 450 patent applications filed or granted worldwide, Bridgelux is the only vertically integrated LED manufacturer that designs its solutions specifically for the lighting industry.

For more information about the company, please visit www.bridgelux.com

© 2011 Bridgelux, Inc. All rights reserved. Product specifications are subject to change without notice.



X-ON Electronics

Largest Supplier of Electrical and Electronic Components

Click to view similar products for [bridgelux](#) manufacturer:

Other Similar products are found below :

[BXRC-30E1000-C-73](#) [BXRC-30E2000-D-73](#) [BXRC-30G1000-C-73](#) [BXRC-35G4000-B-73](#) [BXKE-40G1501-B-23](#) [BXRC-27G10K0-C-72-SE](#) [BXRC-30E2000-B-73](#) [BXRC-50C4001-B-74](#) [BXRC-50G10K1-C-73-SE](#) [BXRE-30E0800-D-73](#) [BXEN-65S-13H-9C-00-0-0](#) [BXRE-50S1001-B-74](#) [BXRE-57S1001-B-74](#) [BXRE-65S1001-B-74](#) [BXRC-30E10K0-D-73-SE](#) [BXKE-27G1501-B-23](#) [BXRC-30G10K0-C-72-SE](#) [BXRV-TR-2765G-30A0-A-23](#) [BXRC-35E4000-F-23](#) [BXRC-30E1000-B-23](#) [BXRC-30E1000-D-73-SE](#) [BXRC-27G2000-C-23](#) [BXRC-27H1000-C-73](#) [BXRH-30E0600-A-73](#) [BXKE-27G0801-A-23](#) [BXKE-30G0801-A-23](#) [BXKE-40G0801-A-23](#) [BXKE-30G1501-B-23](#) [BXKE-40E1500-B-13](#) [BXRC-56G10K0-D-74](#) [BXRC-35E2000-B-73-SE](#) [BXRC-30G10K0-D-73](#) [BXRC-30G2000-C-73-SE](#) [BXRC-35G10K0-D-73](#) [BXRC-35G10K0-D-73-SE](#) [BXRC-30E10K0-D-73](#) [BXRE-35G1000-C-73](#) [BXRC-40E2000-B-73](#) [BXRC-40G1000-D-73](#) [BXRV-DR-1830H-3000-A-13](#) [BXRC-27E4000-F-23](#) [BXRC-40E4000-B-73](#) [BXRC-40E10K0-B-73](#) [BXRE-30S1001-C-73](#) [BXRC-35G2000-C-73-SE](#) [BXRC-30H10K0-D-73](#) [BXRC-30G2000-D-73-SE](#) [BXRC-35E4000-D-73](#) [BXRC-40E2000-D-73-SE](#) [BXRE-50S4001-C-74](#)