

REVISION N

DO NOT SCALE FROM THIS PRINT

TABLE 1 (SEE NOTE 7)		
SPACE OPTION + POST HEIGHT	PACKAGING TUBE	PLUG
.300 TO .725 [7.62 TO 18.42]	PT-1-24-16-29	TP-07
.726 TO .820 [18.44 TO 20.83]	PT-1-24-01-67	TP-13
.821 TO 1.080 [20.85 TO 27.43]	PT-HPW001-P	TP-26

UNLESS OTHERWISE NOTED  
 DIMENSIONS ARE IN INCHES TOLERANCES ARE:  
 ONE PLACE DECIMALS ±.1[2.5] THREE PLACE DECIMALS ±.003[.08] ANGLES ± 2°  
 TWO PLACE DECIMALS ±.01[.25] FOUR PLACE DECIMALS ±.0015[.038]

TITLE:  
 .200 HIGH POWER STACKER, ASM

DWG NO:  
 HPW-XX-XX-XX-X-XXX-XXX-XX-X  
 SHEET 1 OF 1

TABLE 2	
FORM	BODY
T/H	FSW-20-200
VS	HFSW-20-200

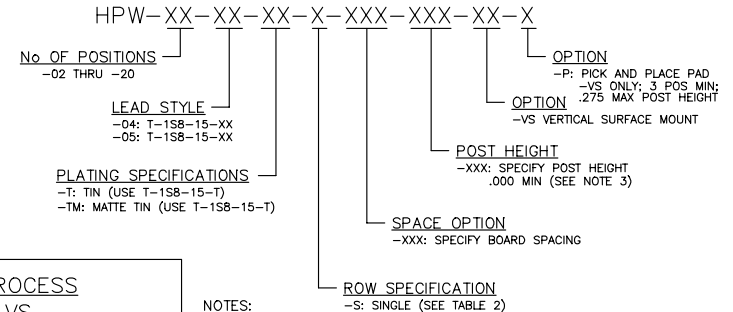
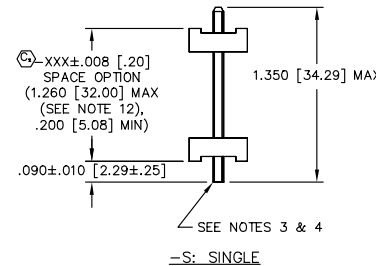
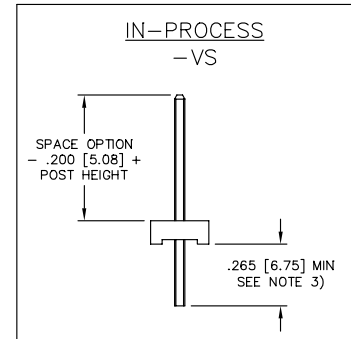
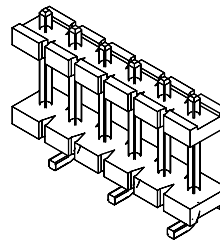
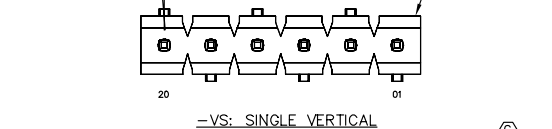
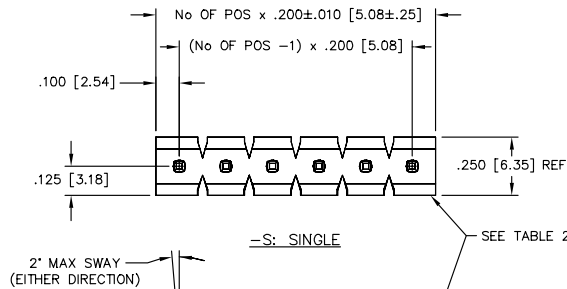

- NOTES:
- HEIGHT VARIATION BETWEEN ANY TWO PINS SHALL BE .010 MAX.
  - MAXIMUM PIN ROTATION IN BODY: 2°.
  - TAIL TO BE SHEARED TO .265 [6.73] MIN. A SECOND SHEAR STEP WILL BE NEEDED AFTER FORMING TO ACHIEVE THE TAIL TO TAIL DIM.
  - MAXIMUM BURR ALLOWED: .004 [.10].
  - MAXIMUM BURR ALLOWED: .0015 [.038].
  - THROUGH HOLE (-S) TO BE BULK PACKAGED.
  - SURFACE MOUNT (-VS) TO BE PACKAGED AS FOLLOWS:  
 POSITIONS -04 THRU -20 ARE TO BE PACKAGED IN TUBES;  
 POSITIONS -02 & -03 ARE TO BE LAYERED PACKAGED.
  - MIN PUSHOUT FORCE TO BE 3 LBS.
  - MAX CUT FLASH TO BE .020 [.51].
  - ⊙ REPRESENTS A CRITICAL DIMENSION.
  - ALL PARTS WITH PICK AND PLACE PAD TO USE PACKAGING TUBE PT-HPW001-P AND TP-26 PLUGS.
  - POST + SPACE OF 1.300 [33.02] - 1.350 [34.29] WILL NOT HAVE SHEARED TAILS.

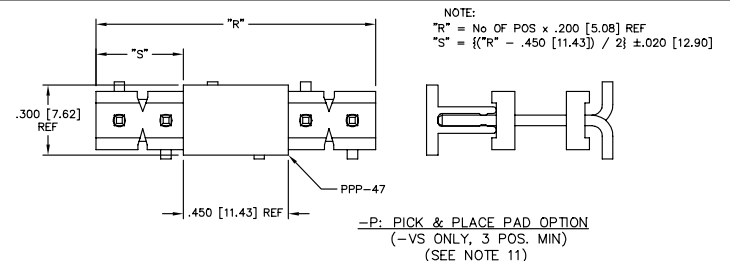
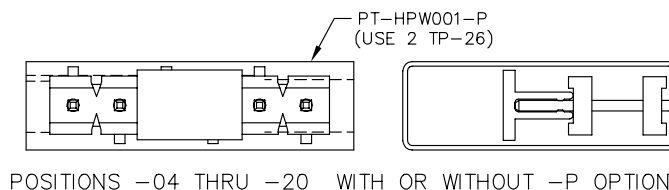
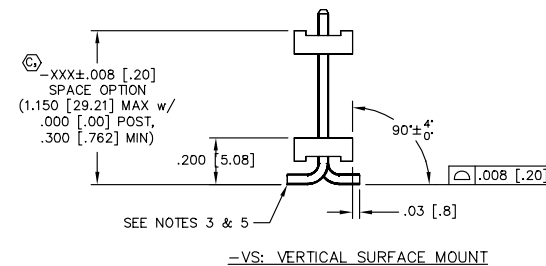

**PROPRIETARY NOTE**  
 THIS DOCUMENT CONTAINS INFORMATION CONFIDENTIAL AND PROPRIETARY TO SAMTEC INC AND SHALL NOT BE REPRODUCED OR TRANSFERRED TO OTHER DOCUMENTS OR DISCLOSED TO OTHERS OR USED FOR ANY PURPOSE OTHER THAN THAT FOR WHICH IT WAS OBTAINED WITHOUT THE EXPRESSED WRITTEN CONSENT OF SAMTEC INC.

PACKAGING VIEW  
 SEE TABLE 1 & NOTE 7

MATERIAL:  
 BODY: VECTRA E1301  
 COLOR: NATURAL UL 94V0  
 TERMINAL: CDA7025  
 MAX BOW ALLOWED: .002 [.05] IN/IN  
 PLOT SCALE: .375/ DIMSCALE: .300

EXISPROD\ASSEMBLY\200  
 HPW-ASM  
**samtec**  
 520 PARK EAST BLVD. NEW ALBANY, INDIANA 47151-1147  
 PHONE (812) 944-6733 P.O. BOX 1147  
 CODE 55322

MADE BY: BURRES 08-21-98 HPW-XX-XX-XX-X-XXX-XXX-XX-X

## X-ON Electronics

Largest Supplier of Electrical and Electronic Components

*Click to view similar products for [Power to the Board](#) category:*

*Click to view products by [Samtec](#) manufacturer:*

Other Similar products are found below :

[10131318-08512GRLF](#) [6450171-4](#) [6450552-7](#) [6600323-8](#) [6643429-1](#) [6646040-2](#) [6651939-1](#) [6766604-1](#) [120959-1](#) [1393557-2](#) [1393532-2](#)  
[1393532-3](#) [1393532-4](#) [1393557-1](#) [1600812-5](#) [1-6450861-2](#) [1645595-1](#) [1743490-1](#) [1744132-7](#) [1761122-1](#) [1766169-1](#) [1766250-1](#) [18362](#)  
[1892109-1](#) [1-967627-6](#) [2226808-1](#) [2-6450860-5](#) [2-6450860-6](#) [2-6450870-0](#) [93003-0502](#) [953552-1](#) [1-6450161-4](#) [1-6450850-6](#) [1645526-2](#) [1-](#)  
[6600130-0](#) [1743419-1](#) [1766150-1](#) [2005243-2](#) [211110-1](#) [2-6600130-2](#) [TE34-12-16P-F0](#) [51700-10201602AALF](#) [5-6450830-6](#) [5646956-4](#)  
[36662-0005](#) [40585-3000](#) [4-6450830-9](#) [4-6600333-3](#) [51142-0214](#) [10125416-4050LF](#)