

High Drive Fundamental Quartz Crystal Oscillator

■GENERAL DESCRIPTION

The NJU6368 series is a C-MOS fundamental quartz crystal oscillator that consists of an oscillation amplifier, 3-stage divider and 3-state output buffer.

The 3-stage divider generates only one frequency selected of $f_0, f_0/2, f_0/4$ and $f_0/8$ by internal circuits is output.

The oscillation amplifier is realized very low stand-by current using NAND circuit.

The 3-state output buffer is C-MOS compatible and can drive 50pF(@5V) C-MOS load.

Furthermore, the package is small-sized MTP-6.

■PACKAGE OUTLINE



NJU6368XC-C

NJU6368XF1

■FEATURES

- Operating Voltage 2.7 to 5.5V
- Maximum Oscillation Frequency 50MHz
- Low Operating Current
- High Fan-out $I_{OH}/I_{OL}=8mA@3.3V$
 $I_{OH}/I_{OL}=16mA@5.0V$
- 3-Stage Divider Maximum Divider $f_0/8$
- Oscillation Stop and Output Stand-by Function
- 3-State Output Buffer
- Oscillation Capacitors C_g and C_d on-chip
- Package Outline Thin-Chip/MTP-6
- C-MOS Technology

■PAD LOCATION

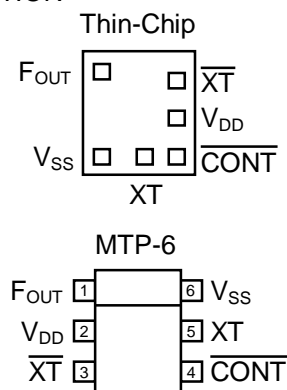

■LINE-UP TABLE

Type No.	F _{OUT}	Internal Connect	C _g /C _d
NJU6368	A	f_0	Connected A Line
	B	$f_0/2$	Connected B Line
	C	$f_0/4$	Connected C Line
	D	$f_0/8$	Connected D Line
	P	f_0	Connected A Line

■COORDINATES

No	Pad Name	X	Y
1	F _{OUT}	-207	247
2	V _{SS}	-207	-247
3	XT	33	-247
4	CONT	207	-247
5	V _{DD}	207	-17
8	XT	207	172

Starting Point: Chip Center Unit[um]
 Chip Size: 0.67x0.75mm
 Thin-Chip Thickness: 260±20um
 Pad Size: 90x90um

■BLOCK DIAGRAM

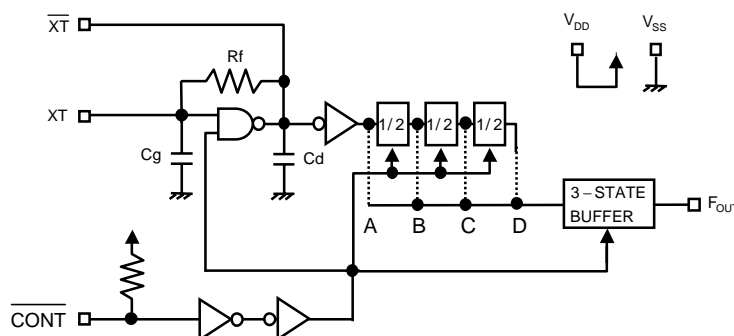

■TERMINAL DESCRIPTION

SYMBOL	FUNCTION	
$\overline{\text{CONT}}$	Oscillation and 3-state Output Buffer Control	
	$\overline{\text{CONT}}$	F_{OUT}
	H or OPEN	Output either one frequency selected of f_0 , $f_0/2$, $f_0/4$ and $f_0/8$ (Note1)
	L	Oscillation Stop and High impedance Output
$\overline{\text{XT}}$	Quartz Crystal Connecting Terminals	
$\overline{\text{XT}}$		
V_{SS}	$V_{\text{SS}}=0\text{V}$	
F_{OUT}	Frequency Output	
V_{DD}	$V_{\text{DD}}=3.3\text{V}/5.0\text{V}$	

Note1) Refer to the line-up table.

■ABSOLUTE MAXIMUM RATINGS

($T_a=25^\circ\text{C}$)

PARAMETER	SYMBOL	RATING	UNIT
Supply Voltage	V_{DD}	-0.5 to +7.0	V
Input Voltage	V_{IN}	$V_{\text{SS}}-0.5$ to $V_{\text{DD}}+0.5$	V
Output Voltage	V_{O}	-0.5 to $V_{\text{DD}}+0.5$	V
Input Current	I_{IN}	± 10	mA
Output Current	I_{O}	± 25	mA
Power Dissipation Note 4)	P_{D}	200(MTP-6)	mW
Operating Temperature Range	T_{opr}	-40 to +85	$^\circ\text{C}$
Storage Temperature Range	T_{stg}	-55 to +125	$^\circ\text{C}$

Note2) If the supply voltage(V_{DD}) is less than 7.0V, the input voltage must not over the V_{DD} level though 7.0V is limit specified.

Note3) Decoupling capacitor should be connected between V_{DD} and V_{SS} due to the stabilized operation for the circuit.

Note4) Power Dissipation is the maximum value of a package simple substance.

■ ELECTRICAL CHARACTERISTICS

(Ta=25°C)

PARAMETER	SYMBOL	CONDITIONS	MIN	TYP	MAX	UNIT
Operating Voltage	V _{DD}		2.7		5.5	V

(V_{DD}=3.3V, Ta=25°C)

PARAMETER	SYMBOL	CONDITIONS	MIN	TYP	MAX	UNIT
Operating Current	I _{DD}	A version, fosc=16MHz, C _L =30pF			8	mA
		B version, fosc=16MHz, C _L =30pF			6	
		C version, fosc=16MHz, C _L =30pF			4	
		D version, fosc=16MHz, C _L =30pF			3	
		P version, fosc=16MHz, C _L =30pF Note5)			8	
Oscillation Stopping Current	I _{STB}	$\overline{\text{CONT}} = V_{SS}$, No load		2	5	uA
Stand-by Current	I _{st}	$\overline{\text{CONT}} = \text{XT} = V_{SS}$, No load Note6)			1	uA
Input Voltage	V _{IH}		2.31		3.3	V
	V _{IL}		0		0.99	V
Output Current	I _{OH}	V _{OH} =2.97V	8			mA
	I _{OL}	V _{OL} =0.33V	8			mA
Input Current	I _{IN}	$\overline{\text{CONT}} = 0.8V_{DD}$		10.0	15.0	uA
		$\overline{\text{CONT}} = 0.2V_{DD}$		1.8	3.0	uA
3-state Off Leakage Current	I _{OZ}	$\overline{\text{CONT}} = V_{SS}$, F _{OUT} = V _{DD} or V _{SS}			±0.1	uA
Feedback Resistance	R _f			255		KΩ
Internal Capacitor	C _g /C _d	fosc=16MHz, A/B/C/D version		15/15		pF
		P version		-		
Maximum Oscillation Frequency	F _{MAX}		50			MHz
Output Signal Symmetry	SYM	C _L =15pF, @V _{DD} /2	45	50	55	%
		C _L =30pF, @V _{DD} /2	45	50	55	
Output Signal Rise Time	tr	C _L =15pF, 10% to 90%		2	4	ns
		C _L =30pF, 10% to 90%		4	8	
Output Signal Fall Time	tf	C _L =15pF, 90% to 10%		2	4	ns
		C _L =30pF, 90% to 10%		4	8	
Output Disable time	T _{PLZ}	C _L =15pF, R _{UP} =10kΩ			150	ns
Output Enable Time	T _{PZL}	C _L =15pF, R _{UP} =10kΩ			150	ns

Note5) P version is measured with external capacitors contained 13pF for C_g and 13pF for C_d.

Note6) Excluding input current on $\overline{\text{CONT}}$ terminal.

($V_{DD}=5.0V, T_a=25^{\circ}C$)

PARAMETER	SYMBOL	CONDITIONS	MIN	TYP	MAX	UNIT
Operating Current	I_{DD}	A version, $f_{osc}=16MHz, C_L=50pF$			15	mA
		B version, $f_{osc}=16MHz, C_L=50pF$			11	
		C version, $f_{osc}=16MHz, C_L=50pF$			9	
		D version, $f_{osc}=16MHz, C_L=50pF$			7	
		P version, $f_{osc}=16MHz, C_L=50pF$ Note5)			15	
Oscillation Stopping Current	I_{STB}	$\overline{CONT} = V_{SS}$, No load		5	10	uA
Stand-by Current	I_{st}	$\overline{CONT} = XT = V_{SS}$, No load Note6)			1	uA
Input Voltage	V_{IH}		3.5		5.0	V
	V_{IL}		0		1.5	V
Output Current	I_{OH}	$V_{OH}=4.5V$	16			mA
	I_{OL}	$V_{OL}=0.5V$	16			mA
Input Current	I_{IN}	$\overline{CONT} = 0.8V_{DD}$		27.0	40.0	uA
		$\overline{CONT} = 0.2V_{DD}$		5.5	8.0	uA
3-state Off Leakage Current	I_{OZ}	$\overline{CONT} = V_{SS}$, $F_{OUT} = V_{DD}$ or V_{SS}			± 0.1	uA
Feedback Resistance	R_f			255		K Ω
Internal Capacitor	C_g/C_d	$f_{osc}=16MHz$, A/B/C/D version		15/15		pF
		P version		-		
Maximum Oscillation Frequency	F_{MAX}		50			MHz
Output Signal Symmetry	SYM	$C_L=15pF$, @ $V_{DD}/2$	45	50	55	%
		$C_L=50pF$, @ $V_{DD}/2$	45	50	55	
Output Signal Rise Time	t_r	$C_L=15pF$, 10% to 90%		2	4	ns
		$C_L=50pF$, 10% to 90%		4	8	
Output Signal Fall Time	t_f	$C_L=15pF$, 90% to 10%		2	4	ns
		$C_L=50pF$, 90% to 10%		4	8	
Output Disable time	T_{PLZ}	$C_L=15pF, R_{UP}=10k\Omega$			100	ns
Output Enable Time	T_{PZL}	$C_L=15pF, R_{UP}=10k\Omega$			100	ns

Note5) P version is measured with external capacitors contained 13pF for C_g and 13pF for C_d .

Note6) Excluding input current on \overline{CONT} Terminal.

MEASUREMENT CIRCUITS

(1) Output Signal Symmetry ($C_L=15/30/50\text{pF}$)

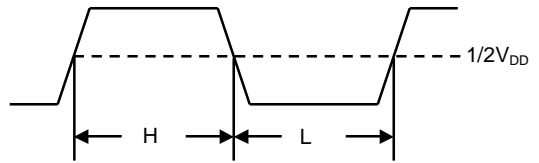
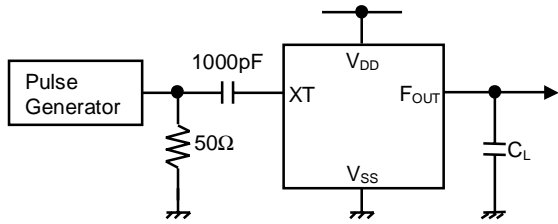

(2) Output Signal Rise/Fall Time ($C_L=15/30/50\text{pF}$)

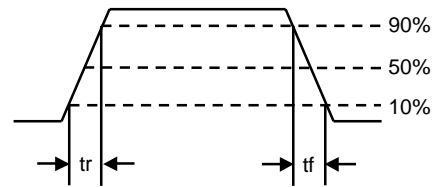
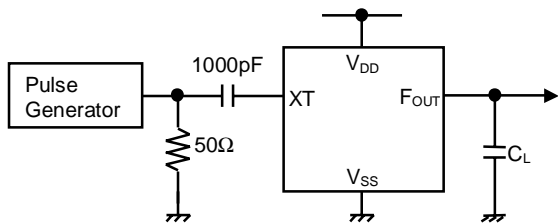

(3) Output Disable/Enable Time ($C_L=15\text{pF}, R_{UP}=10\text{k}\Omega$)

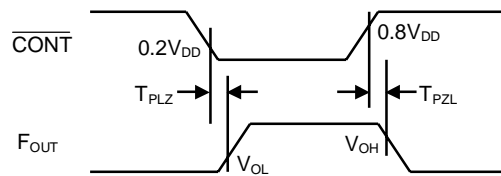
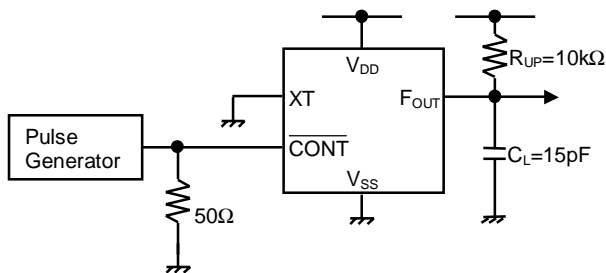

[CAUTION]
 The specifications on this data book are only given for information, without any guarantee as regards either mistakes or omissions. The application circuits in this data book are described only to show representative usages of the product and not intended for the guarantee or permission of any right including the industrial rights.

X-ON Electronics

Largest Supplier of Electrical and Electronic Components

Click to view similar products for [Standard Clock Oscillators](#) category:

Click to view products by [NJR](#) manufacturer:

Other Similar products are found below :

[EP1400SJTSC-125.000M](#) [601137](#) [601252](#) [CSX750FBC-24.000M-UT](#) [CSX750FBC-33.333M-UT](#) [CSX750FCC-3.6864M-UT](#) [F335-12](#) [F335-25](#) [F535L-50](#) [DSC506-03FM2](#) [ASA-20.000MHZ-L-T](#) [ASA-25.000MHZ-L-T](#) [ASA-27.000MHZ-L-T](#) [ASV-20.000MHZ-LR-T](#) [ECS-2018-160-BN-TR](#) [EL13C7-H2F-125.00M](#) [MXO45HS-2C-66.6666MHZ](#) [NBXDBB017LN1TAG](#) [NBXHBA019LN1TAG](#) [SiT1602BI-22-33E-50.000000E](#) [SIT8003AC-11-33S-2.04800X](#) [SiT8256AC-23-33E-156.250000X](#) [SIT8918AA-11-33S-50.000000G](#) [SM4420TEV-40.0M-T1K](#) [SMA4306-TL-H](#) [F335-24](#) [F335-40](#) [F335-50](#) [F535L-10](#) [F535L-12](#) [F535L-16](#) [F535L-24](#) [F535L-27](#) [F535L-48](#) [PE7744DW-100.0M](#) [CSX750FBC-20.000M-UT](#) [CSX-750FBC33333000T](#) [CSX750FBC-4.000M-UT](#) [CSX750FBC-7.3728M-UT](#) [CSX750FBC-8.000M-UT](#) [CSX-750FCC14745600T](#) [CSX750FCC-16.000M-UT](#) [CSX-750FCC40000000T](#) [CSX750FCC-4.000M-UT](#) [ASA-22.000MHZ-L-T](#) [ASA2-26.000MHZ-L-T](#) [ASA-40.000MHZ-L-T](#) [ASA-48.000MHZ-L-T](#) [ASA-60.000MHZ-L-T](#) [ASF1-3.686MHZ-N-K-S](#)