



ITT

Electronic Components

Cannon Trident Connectors



Engineered for life

Interconnect Technologies & Solutions for the Transportation Industry

For over 90 years, ITT has been developing innovative solutions for harsh environment applications. We have a proven track record of demonstrating our expertise and commitment to the transportation industry, offering the broadest portfolio of interconnect products.

Off-Road / Heavy Vehicle

Our interconnect range include sealed circulars, plastic and metal shell bayonet coupling circulars, miniature metal shell circulars, PC board header connectors and sensor and direct device connectors. ITT is also a systems supplier, providing value-added module and harness assemblies.

**In addition to our Trident series,
we also offer these connectivity solutions:**



VEAM VBN

Completely intermateable with VEAM VG95234/CIR reverse bayonet connectors.



Cannon APD

In-line and bulkhead connectors resistant to harsh environmental conditions (contaminants, vibration and shock).



Cannon SLC/SLE

Environmentally sealed connector created for printed circuit board, black box, cable-to-cable or bulkhead applications.



Cannon MLC

The MLC is a modular landed contact system featuring a plug only assembly. The plug housing interfaces directly with the PCB, achieving cost savings of over 30%.

The ITT "Engineered Blocks" symbol and the composite ITT logo are registered trademarks of ITT Industries. © 2005



Cannon’s Trident Connector System is a versatile range of electrical connectors based on a standard contact design. These contacts are fully interchangeable throughout the Trident Connector System. The connector options include low cost rectangulars, rack and panel, industrial grade circulars, harsh environment circulars and shielded circulars

Description

Trident Connector System

Connector Selection Guide	4-5
• Snap Together - Rectangular	
Introduction	6
Contact Cavity Arrangements	7
Connectors	8-11
• Snap Together - Slimline	
Introduction	12
Connectors	13-15
• Multway Rack & Panel Connectors	
Introduction	16
Contact Cavity Arrangements	17
How to Order	18
Style Selector - Hardware Selection Guide	19
• Ringlock Circular Connectors	
Introduction	20
Contact Cavity Arrangements	21
Connectors	22-25
Accessories	26-27
• Neptune Circular Connectors	
Introduction	28
Contact Cavity Arrangements	29
Connectors	30-33
Accessories	34-37
• TNM Circular Connectors	
Introduction	38
Contact Cavity Arrangements	39
Connectors	40-41
Accessories	42-45
Contact Selection Guide	46
Performance Data	47
Contacts	48-52
Application Tools	53-54
Assembly Instructions	55-62
Reader’s Resource	
IP Rating Chart	64-65
Glossary of Terms	66-67
Part Number Index	68-69
Product Safety Information	70
Warranty	70

Connector Selection Guide

Snap Together Rectangular

Snap Together Slimline

Multway Rack & Panel

Ringlock Circular

Neptune Circular

TNM Circular

Contacts

Tools

Assembly

Reader’s Resource



Cannon Trident Connector System

Connector Selection Guide

Snap Together - Rectangular



Snap Together - Rectangular

These are low installed cost connectors rated for up to 13 A and 250 Vrms. They are typically used for circuit board and internal wiring applications. Snap Together connectors facilitate easy assembly and removal of equipment such as motors, fans, and transformers.

Contents

Introduction	6
Contact Cavity Arrangements	7
Free Plug Connectors	8
Panel Mounted Receptacles	9
PCB Receptacles	10

Snap Together - Slimline



Snap Together - Slimline

The Slimline Range offers a low profile connector system that is well suited for circuit board applications. The precision machined contacts are ideal for power and sensitive signals.

Contents

<i>Rectangular Range</i>	
Introduction	12
Plug Connector	13
Pin Header - Straight	14
Pin Header - 90°	15

Multiway - Rack & Panel



Multiway

The Multiway range is an extremely reliable and robust series of rack and panel connectors. The design is based on the requirements of MIL-C-28748 and will accept any of the Trident signal or coax contacts. It is available in 6 arrangements ranging from 14 to 75 ways, together with a wide range of accessories and mounting hardware.

Contents

Introduction	16
Contact Cavity Arrangements	17
How to Order	18
Hardware Selection Guide	19

Ringlock - Circular



Ringlock

Ringlock is a range of robust circular connectors for industrial applications. It uses a metal bayonet coupling system for quick and reliable connections and thermoplastic bodies for low installed cost. The connectors are available in several sizes ranging from 4 to 48 circuits for signals up to 13 A or coax. With the addition of a sealed cable clamp, the connectors can be water sealed to meet IP67.

Contents

Introduction	20
Contact Cavity Arrangements	21
Standard Connectors	22
Reversed Connectors	25
Accessories	26

Cannon Trident Connector System

Neptune - Circular



Neptune

Neptune is a range of circular connectors specifically designed for harsh environment applications. They are water sealed to IP67 and do not require blanking plugs for unused cavities. Contact arrangements include combinations of signal (13 A) and power (30 A) contacts. The mating uses a highly reliable bayonet coupling system with either high strength metal or corrosion resistant plastic coupling rings.

Contents

Introduction	28
Contact Cavity Arrangements	29
Standard Connectors	30
Reversed Connectors	32
Accessories	34

TNM - Circular



TNM

TNM is a new series of metal shell connectors that, when used with the new shielded end bell, provides RF shielding from cable to equipment or cable to cable. Connectors and end bells are moisture sealed to IP67. They are ideal for applications that require the additional strength of metal shells.

Contents

Introduction	38
Contact Cavity Arrangements	39
Standard Connectors	40
Reversed Connectors	41
Jam Nut Receptacles	42
Special Products	42
Accessories	43

Trident Contacts



Trident Contacts

The Trident series of contacts are based on a standard cavity design. This enables the stamped, machined, PCB, solder, and coax contacts to fit into any of the connectors in the Trident connector system. In addition, the mating interface is standardized so that the various signal contacts (ranging from 14-26 AWG) will all mate together. The retention system of the contacts enables quick and cost effective assembly without special insertion tools.

Contents

Introduction	46
Contact Selection Guide	47
Formed (Stamped) Contacts	48
Machined Contacts	49
Solder Contacts	50
30 A Power Contacts	50
Coaxial Contacts	51
Discriminating (Keying) Pins	52

Application Tools and Assembly Instructions



Tools and Assembly

Cannon offers a wide range of wire preparation and crimping tools ranging from hand tools to fully automated systems. There is also a range of assembly aids and extraction tools.

Contents

Hand Crimping Tools	53
Automatic Tools	54
Insertion/Extraction Tools	54
Contact Assembly Instructions	55
Connector Assembly Instructions	56

Cannon Trident Connector System

Snap Together-Rectangular

Snap Together
Rectangular

These are low installed cost connectors rated for up to 13 A and 250 V ac. They are typically used for circuit board and internal wiring applications. Snap Together connectors facilitate easy assembly and removal of equipment such as motors, fans, transformers, etc.

Applications:

- Circuit board connections.
- Internal connections.

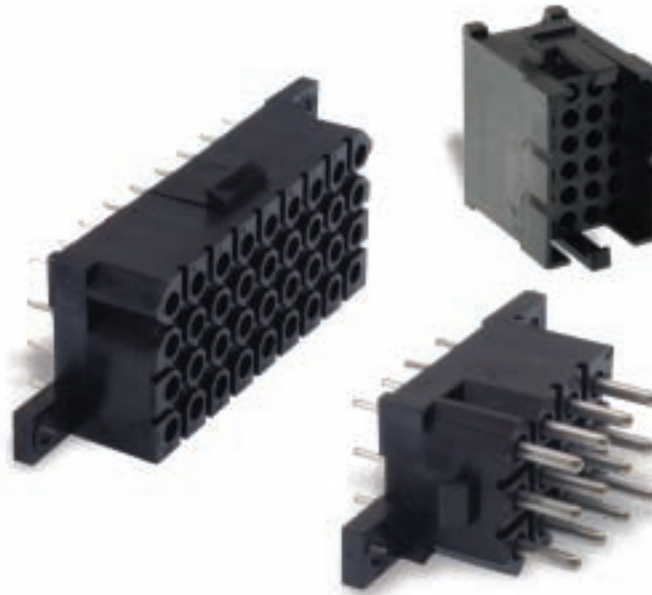

Product Features

- Easy cost effective installation.
- Integrally molded latches and connector polarization.
- Recognized under the component program of UL Inc. and CSA.
- Inter-connector discrimination facilities available.
- Accepts formed (stamped) or machined contacts, see page 47.

Performance Specifications

Operating Voltage	250 V ac rms
Contact Current Rating	Up to 13 A (For derating curve, see page 44)
Temperature Range	-55°C to 105°C (-67°F to 221°F) for Free Plug and Panel Receptacles -40°C to 105°C (-40°F to 221°F) for PCB Mounted Receptacles
Insulation Resistance	5000 MΩ at 500 V dc
Connector Latching Force	150 N min. with latches engaged
Test Voltage	2000 V ac for 60 secs
Panel Retention Force	500 N min.

Materials and Finishes

Description	Material	Finish
Insulator	Black Nylon, UL 94V-0	None



Dimensions shown in mm (inch)
Specifications and dimensions subject to change

www.ittcannon.com

Contact Cavity Arrangements—Mating Face View

2 Way

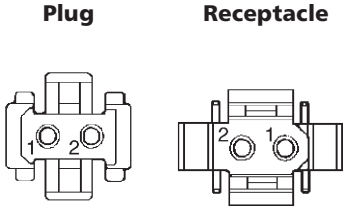

3 Way

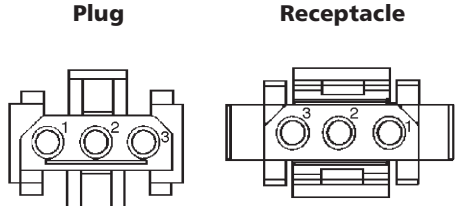

4 Way

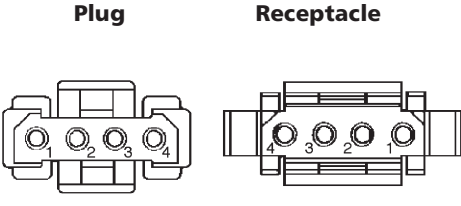

6 Way

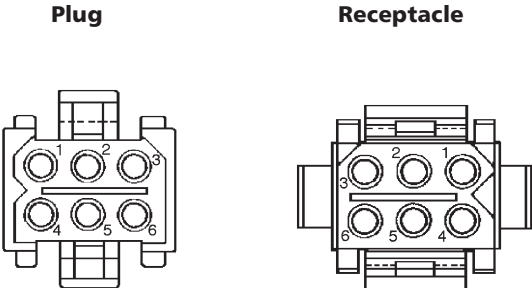

12 Way

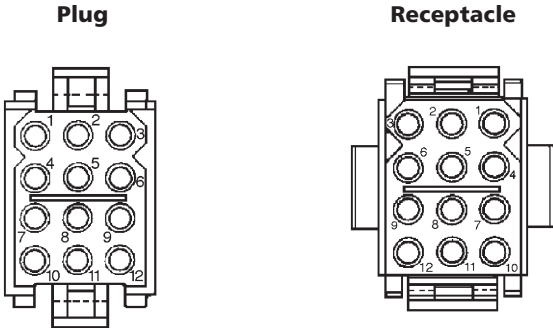

24 Way

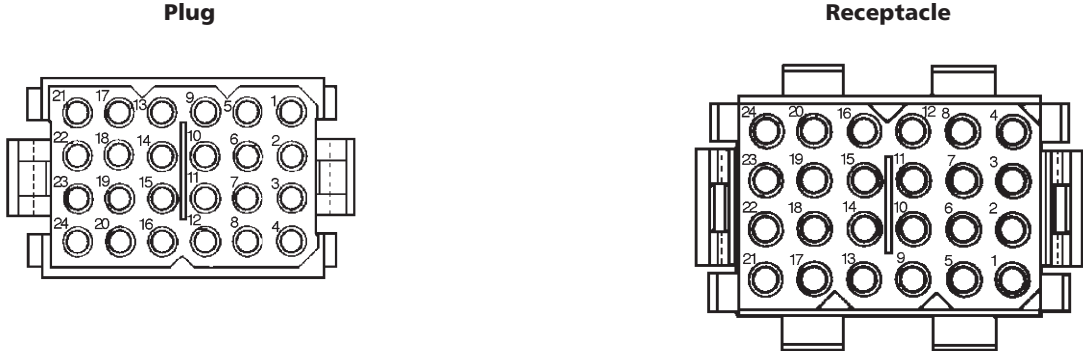

36 Way

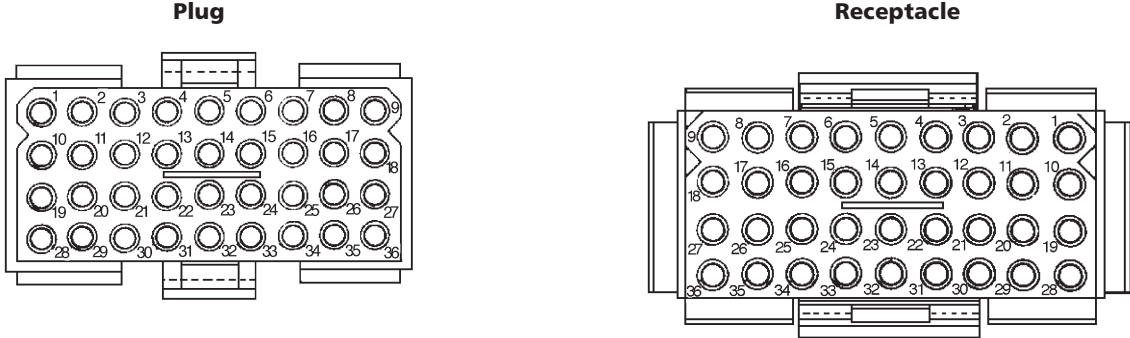

Dimensions shown in mm (inch)
Specifications and dimensions subject to change
www.ittcannon.com



Snap Together
Rectangular

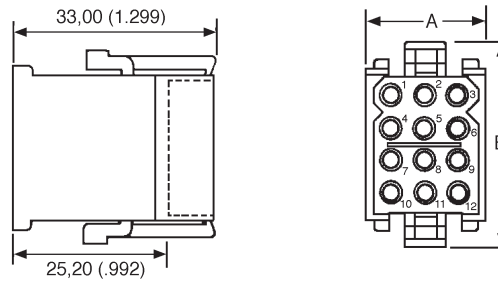

Free Plug

- Accepts Pin or Socket contacts.
- Contacts to be ordered separately, see page 47.
- Mates with panel mounted receptacles, see page 9.
- Mates with PCB mounted receptacles, see pages 10-12.

Number of Contacts	Part Number (Pack of 100)	Nomenclature	Dimensions (max.)	
			A	B
2	192990-0350	TST 02 PA 00	15,50 (.610)	17,00 (.669)
3	192923-5920	TST 03 PA 00	19,00 (.748)	17,00 (.669)
4	192990-0370	TST 04 PA 00	24,00 (.944)	17,00 (.669)
6	192923-5930	TST 06 PA 00	19,00 (.748)	22,00 (.866)
12	192923-5940	TST 12 PA 00	19,00 (.748)	32,00 (1.259)
24	192923-5950	TST 24 PA 00	24,00 (.944)	42,00 (1.653)
36	192923-5960	TST 36 PA 00	49,50 (1.948)	32,00 (1.259)

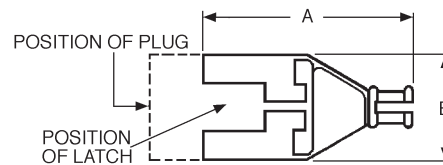

Plug Strain Relief Hood

- Provides strain relief and wire protection.
- Secure with a tie-wrap (customer supplies tie-wrap).
- Connector Discriminating (Keying) Pins available, see page 52.

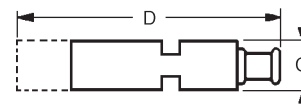

Number of Contacts	Part Number (Pack of 100)	Nomenclature	Wire Bundle Dia.	Dimensions (max.)			
				A	B	C	D
2	192990-0460	TST 02 AH 00	2,30-8,30 (.090-.326)	46,20 (1.818)	16,10 (.633)	11,00 (.433)	56,50 (2.224)
3	192990-0470	TST 03 AH 00	2,30-8,30 (.090-.326)	46,20 (1.818)	18,60 (.732)	11,00 (.433)	56,50 (2.224)
4	192990-0480	TST 04 AH 00	3,00-10,00 (.118-.393)	46,20 (1.818)	23,70 (.933)	11,00 (.433)	56,50 (2.224)
6	192923-5970	TST 06 AH 00	2,30-8,30 (.090-.326)	46,20 (1.818)	19,00 (.748)	16,40 (.645)	56,50 (2.224)
12	192923-5980	TST 12 AH 00	3,00-10,00 (.118-.393)	45,50 (1.791)	19,00 (.748)	26,40 (1.039)	55,80 (2.196)
24	192923-5990	TST 24 AH 00	4,60-12,70 (.181-.500)	51,00 (2.007)	24,10 (.948)	36,80 (1.448)	60,30 (2.374)
36	192923-6000	TST 36 AH 00	7,00-15,90 (.275-.625)	57,50 (2.263)	49,50 (1.948)	26,40 (1.039)	68,00 (2.677)



Dimensions shown in mm (inch)
Specifications and dimensions subject to change

www.ittcannon.com

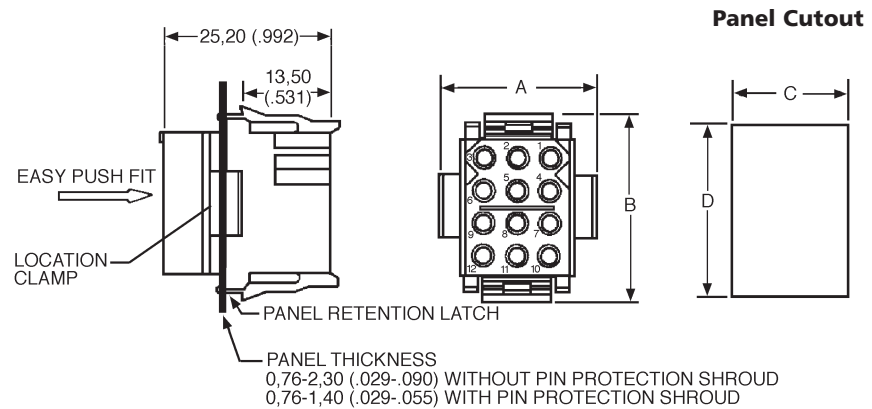

Snap Together Rectangular

Receptacle — Panel Mounted

- Accepts Pin or Socket contacts.
- Contacts to be ordered separately, see page 47.
- Mates with Free Plugs, see page 8.

Number of Contacts	Part Number (Pack of 100)	Nomenclature	Dimensions			
			A	B	C ±0,13 (.005)	D ±0,13 (.005)
2	192990-0360	TST 02 RA 00	19,00 (.748)	14,00 (.551)	11,50 (.452)	11,60 (.456)
3	192923-6010	TST 03 RA 00	24,00 (.944)	14,00 (.551)	16,50 (.649)	11,60 (.456)
4	192990-0380	TST 04 RA 00	29,00 (1.141)	13,50 (.531)	21,70 (.854)	11,60 (.456)
6	192923-6020	TST 06 RA 00	24,00 (.944)	19,00 (.748)	16,50 (.649)	16,70 (.657)
12	192923-6030	TST 12 RA 00	24,00 (.944)	29,00 (1.141)	16,70 (.657)	26,70 (1.051)
24	192923-6040	TST 24 RA 00	29,00 (1.141)	39,00 (1.535)	21,80 (.858)	36,90 (1.452)
36	192923-6050	TST 36 RA 00	54,20 (2.133)	29,00 (1.141)	46,70 (1.838)	26,40 (1.039)

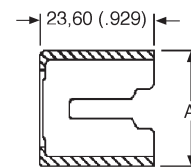
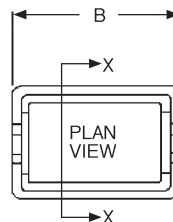

Section X-X

Protection Shrouds for Receptacles with Pin Contacts

- Provides protection for panel mounted receptacles with pin contacts.
- Shrouds can be fitted onto panels up to 1,40 (.055) thick.
- Connector Discriminating (Keying) Pins available, see page 52.

Number of Contacts	Part Number (Pack of 100)	Nomenclature	Dimensions	
			A	B
3	192990-0400	TST 03 AS 00	23,50 (.925)	19,05 (.748)
4	192991-0668	TST 04 AS 00	28,60 (1.126)	19,05 (.748)
6	192990-0420	TST 06 AS 00	23,50 (.925)	24,13 (.948)
12	192990-0430	TST 12 AS 00	23,60 (.929)	34,20 (1.346)
24	192990-0440	TST 24 AS 00	29,70 (1.169)	44,40 (1.748)
36	192990-0450	TST 36 AS 00	54,40 (2.141)	34,00 (1.338)

Dimensions shown in mm (inch)
Specifications and dimensions subject to change

Cannon Trident Connector System

Snap Together-Rectangular

Snap Together
Rectangular

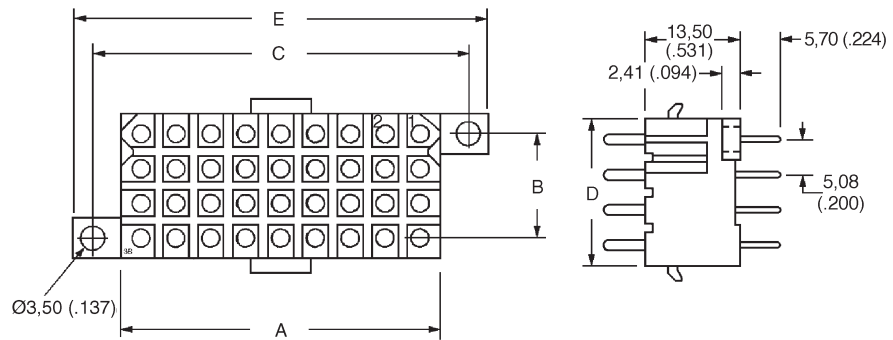
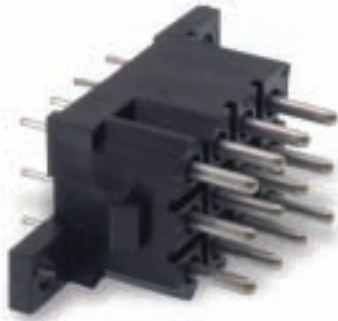

PCB Mounted Connectors — Pin Contacts

- Mates with Free Plug, see page 8.
- Integrally molded flanges.
- Contacts are on a 5,08 (.200) grid, symmetrical on center lines.
- Recommended PCB hole Ø1,15 (.045).
- Connector Discriminating Caps available, see page 52.

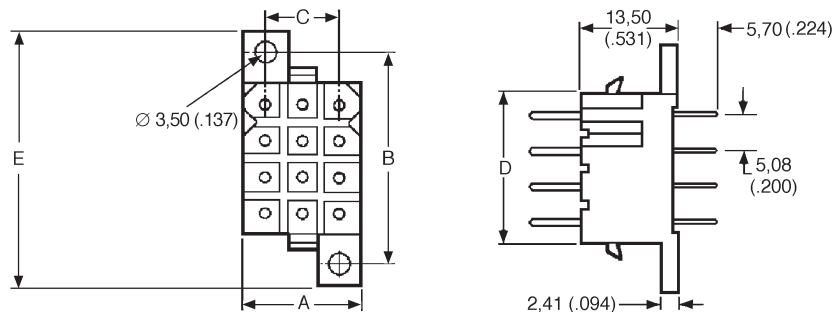

Number of Contacts	Plating	Formed (Stamped)		Machined		Figure	Dimensions				
		Part Number (Pack of 100)	Nomenclature	Part Number (Pack of 100)	Nomenclature		A	B ±0,08 (.003)	C ±0,08 (.003)	D	E
2	Gold*	192900-0411	TST 02 RB 05Y	192991-0270	TST 02 RB 01Z	1	11,13 (.438)	N/A	19,13 (.753)	6,00 (.236)	25,00 (.984)
2	Tin	192990-3230	TST 02 RB 05T	192991-0271	TST 02 RB 01T	1	11,13 (.438)	N/A	19,13 (.753)	6,00 (.236)	25,00 (.984)
3	Gold*	192900-0412	TST 03 RB 05Y	192991-0278	TST 03 RB 01Z	2	16,21 (.638)	14,05 (.553)	10,24 (.403)	6,00 (.236)	20,10 (.791)
3	Tin	192990-3240	TST 03 RB 05T	192991-0279	TST 03 RB 01T	2	16,21 (.638)	14,05 (.553)	10,24 (.403)	6,00 (.236)	20,10 (.791)
4	Gold*	192900-0413	TST 04 RB 05Y	192991-0286	TST 04 RB 01Z	2	21,30 (.838)	14,05 (.553)	15,32 (.603)	6,00 (.236)	20,10 (.791)
4	Tin	192990-3250	TST 04 RB 05T	192991-0287	TST 04 RB 01T	2	21,30 (.838)	14,05 (.553)	15,32 (.603)	6,00 (.236)	20,10 (.791)
6	Gold*	192900-0414	TST 06 RB 05Y	192991-0294	TST 06 RB 01Z	2	16,20 (.637)	19,12 (.752)	10,23 (.402)	11,00 (.433)	26,00 (1.023)
6	Tin	192990-3260	TST 06 RB 05T	192991-0295	TST 06 RB 01T	2	16,20 (.637)	19,12 (.752)	10,23 (.402)	11,00 (.433)	26,00 (1.023)
12	Gold*	192900-0415	TST 12 RB 05Y	192991-0302	TST 12 RB 01Z	2	16,20 (.637)	29,30 (1.153)	10,26 (.404)	21,20 (.834)	35,20 (1.385)
12	Tin	192990-3270	TST 12 RB 05T	192991-0303	TST 12 RB 01T	2	16,20 (.637)	29,30 (1.153)	10,26 (.404)	21,20 (.834)	35,20 (1.385)
24	Gold*	192900-0416	TST 24 RB 05Y	192991-0310	TST 24 RB 01Z	2	21,30 (.838)	39,37 (1.550)	15,32 (.603)	31,30 (1.232)	45,60 (1.795)
24	Tin	192990-3280	TST 24 RB 05T	192991-0311	TST 24 RB 01T	2	21,30 (.838)	39,37 (1.550)	15,32 (.603)	31,30 (1.232)	45,60 (1.795)
36	Gold*	192900-0417	TST 36 RB 05Y	192991-0402	TST 36 RB 01Z	1	46,60 (1.834)	15,24 (.600)	54,64 (2.151)	21,20 (.834)	60,50 (2.382)
36	Tin	192990-3290	TST 36 RB 05T	192991-0403	TST 36 RB 01T	1	46,60 (1.834)	15,24 (.600)	54,64 (2.151)	21,20 (.834)	60,50 (2.382)

* Gold plating for Formed (Stamped) Contacts is 0,75 µm (30 µ in.) min gold. Gold plating for Machined Contacts is gold flash.



Dimensions shown in mm (inch)
Specifications and dimensions subject to change

www.ittcannon.com

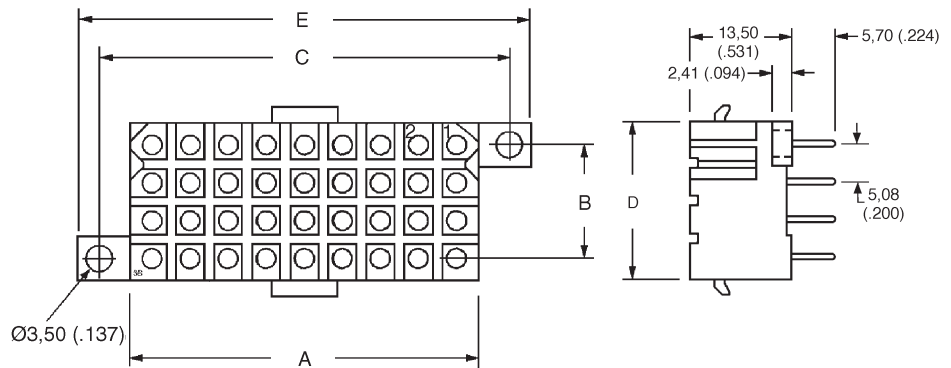

Snap Together Rectangular

PCB Mounted Connectors — Socket Contacts

- Mates with Free Plug, see page 8.
- Integrally molded flanges.
- Contacts are on a 5,08 (.200) grid, symmetrical on center lines.
- Recommended PCB hole Ø 1,15 (.045).
- Connector Discriminating Pins available, see page 52.

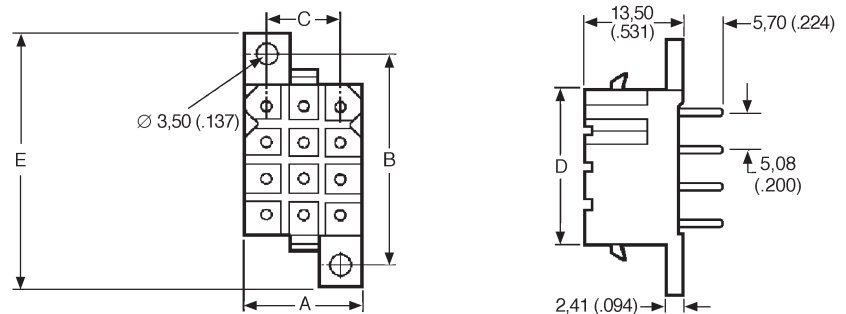

Number of Contacts	Plating	Formed (Stamped)		Machined		Figure	Dimensions					
		Part Number (Pack of 100)	Nomenclature	Part Number (Pack of 100)	Nomenclature		A	±0,08 (.003)	±0,08 (.003)	B	C	D
2	Gold*	192900-0418	TST 02 RB 06Y	192991-0213	TST 02 RB 02Z	1	11,13 (.438)	N/A	19,13 (.753)	6,00 (.236)	25,00 (.984)	
2	Tin	192990-3300	TST 02 RB 06T	192991-0214	TST 02 RB 02T	1	11,13 (.438)	N/A	19,13 (.753)	6,00 (.236)	25,00 (.984)	
3	Gold*	192900-0419	TST 03 RB 06Y	192991-0221	TST 03 RB 02Z	2	16,21 (.638)	14,05 (.553)	10,24 (.403)	6,00 (.236)	20,10 (.791)	
3	Tin	192990-3310	TST 03 RB 06T	192991-0222	TST 03 RB 02T	2	16,21 (.638)	14,05 (.553)	10,24 (.403)	6,00 (.236)	20,10 (.791)	
4	Gold*	192900-0420	TST 04 RB 06Y	192991-0229	TST 04 RB 02Z	2	21,30 (.838)	14,05 (.553)	15,32 (.603)	6,00 (.236)	20,10 (.791)	
4	Tin	192990-3320	TST 04 RB 06T	192991-0230	TST 04 RB 02T	2	21,30 (.838)	14,05 (.553)	15,32 (.603)	6,00 (.236)	20,10 (.791)	
6	Gold*	192900-0421	TST 06 RB 06Y	192991-0237	TST 06 RB 02Z	2	16,20 (.637)	19,12 (.752)	10,23 (.402)	11,00 (.433)	26,00 (1.023)	
6	Tin	192990-3330	TST 06 RB 06T	192991-0238	TST 06 RB 02T	2	16,20 (.637)	19,12 (.752)	10,23 (.402)	11,00 (.433)	26,00 (1.023)	
12	Gold*	192900-0422	TST 12 RB 06Y	192991-0245	TST 12 RB 02Z	2	16,20 (.637)	29,30 (1.153)	10,26 (.404)	21,20 (.834)	35,20 (1.385)	
12	Tin	192990-3340	TST 12 RB 06T	192991-0246	TST 12 RB 02T	2	16,20 (.637)	29,30 (1.153)	10,26 (.404)	21,20 (.834)	35,20 (1.385)	
24	Gold*	192900-0423	TST 24 RB 06Y	192991-0253	TST 24 RB 02Z	2	21,30 (.838)	39,37 (1.550)	15,32 (.603)	31,30 (1.232)	45,60 (1.795)	
24	Tin	192990-3350	TST 24 RB 06T	192991-0254	TST 24 RB 02T	2	21,30 (.838)	39,37 (1.550)	15,32 (.603)	31,30 (1.232)	45,60 (1.795)	
36	Gold*	192900-0424	TST 36 RB 06Y	192991-0261	TST 36 RB 02Z	1	46,60 (1.834)	15,24 (.600)	54,64 (2.151)	21,20 (.834)	60,50 (2.382)	
36	Tin	192990-3360	TST 36 RB 06T	192991-0262	TST 36 RB 02T	1	46,60 (1.834)	15,24 (.600)	54,64 (2.151)	21,20 (.834)	60,50 (2.382)	

* Gold plating for Formed (Stamped) Contacts is 0,75 µm (30 µ in.) min gold. Gold plating for Machined Contacts is gold flash.

The Slimline Range offers a low profile connector system that is well suited for circuit board applications. The precision machined contacts are ideal for power and sensitive signals.

Applications:

- Communications equipment.
- Test equipment.
- Heavy duty equipment.

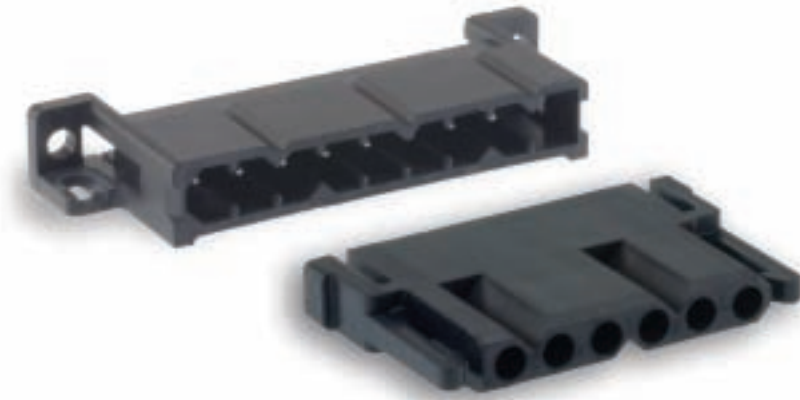

Snap Together Slimline

Product Features

- Less than 10,00 (.393) width on PC board.
- Pin headers pre-loaded with straight or 90° machined solder tail pins.
- Mating plug accepts all Trident signal crimp socket contacts, see page 00.
- Plugs have integrally molded quick connect/disconnect latches.
- Five single row contact arrangements available.
- Recognized under the component program of UL Inc. and CSA.
- Gold plated version available with earth pin capability.
- 10 A per circuit.

Performance Specifications

Operating Voltage	250 V ac rms
Contact Current Rating	Up to 10 A (For derating curve, see page 44)
Temperature Range	-40°C to 105°C (-40°F to 221°F)
Insulation Resistance	5000 MΩ at 500 V dc

Materials and Finishes

Description	Material	Finish
Insulator	Black Nylon, UL 94V-0	None



Dimensions shown in mm (inch)
Specifications and dimensions subject to change

www.ittcannon.com

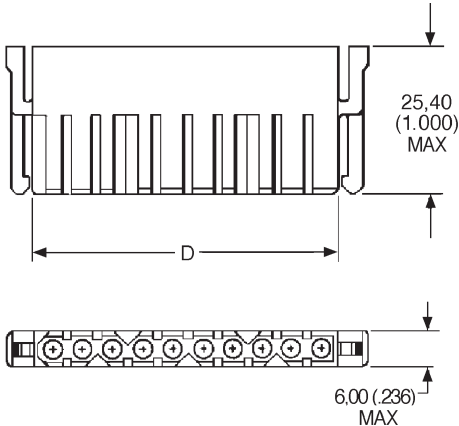

Snap Together Slimline

Plug Connector

- Socket contacts must be ordered separately for the plug connectors, see page 47.

Part Numbers — Plug Connector

Number of Contacts	Part Number (Pack of 100)	Nomenclature	D max.
3	192990-0960	TST 03 PF 00	16,10 (.633)
4	192990-0970	TST 04 PF 00	21,20 (.834)
6	192990-0980	TST 06 PF 00	31,40 (1.236)
9	192990-0990	TST 09 PF 00	46,60 (1.834)
10	192990-1000	TST 10 PF 00	51,60 (2.031)

Dimensions shown in mm (inch)
 Specifications and dimensions subject to change

Snap Together Slimline

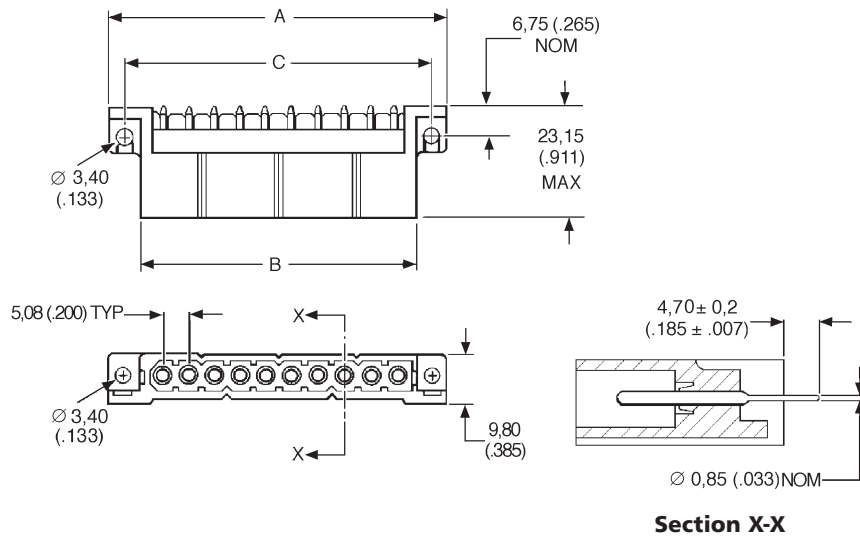

Pin Header — Straight

- For gold plated versions extended earth pins are available in any one or two positions. Contact your local Cannon Sales Office for further details.

Part Numbers — Straight Pin Header

Number of Contacts	Gold Plated Version 0,4 μm (16 μin.) min. Gold		Tin Plated Version		Dimensions (max.)		
	Part Number (Pack of 100)	Nomenclature	Part Number (Pack of 100)	Nomenclature	A	B	C
3	192991-0337	TP 03 R4E 00Y	192991-0316	TST 03 RD 01T	31,40 (1.236)	19,40 (.763)	25,50 (1.003)
4	192991-0347	TP 04 R4E 00Y	192991-0318	TST 04 RD 01T	36,50 (1.437)	14,50 (.964)	30,60 (1.204)
6	192991-0342	TP 06 R4E 00Y	192991-0320	TST 06 RD 01T	46,70 (1.838)	34,70 (1.366)	40,70 (1.602)
9	192991-0536	TP 09 R4E 00Y	192991-0322	TST 09 RD 01T	61,90 (2.437)	49,90 (1.964)	56,00 (2.204)
10	192991-0354	TP 10 R4E 00Y	192991-0324	TST 10 RD 01T	67,00 (2.637)	55,00 (2.165)	61,10 (2.405)

PCB Layout

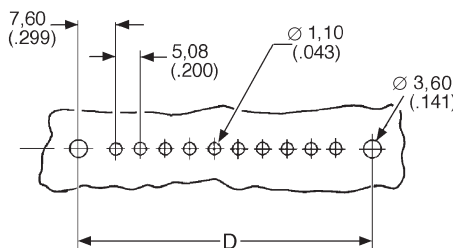

Number of Contacts	D max.
3	25,50 (1.003)
4	30,60 (1.204)
6	40,70 (1.602)
9	56,00 (2.204)
10	61,10 (2.405)



Dimensions shown in mm (inch)
Specifications and dimensions subject to change

www.ittcannon.com



Pin Header — 90°

- For gold plated versions extended earth pins are available in any one or two positions. Contact your local Cannon Sales Office for further details.

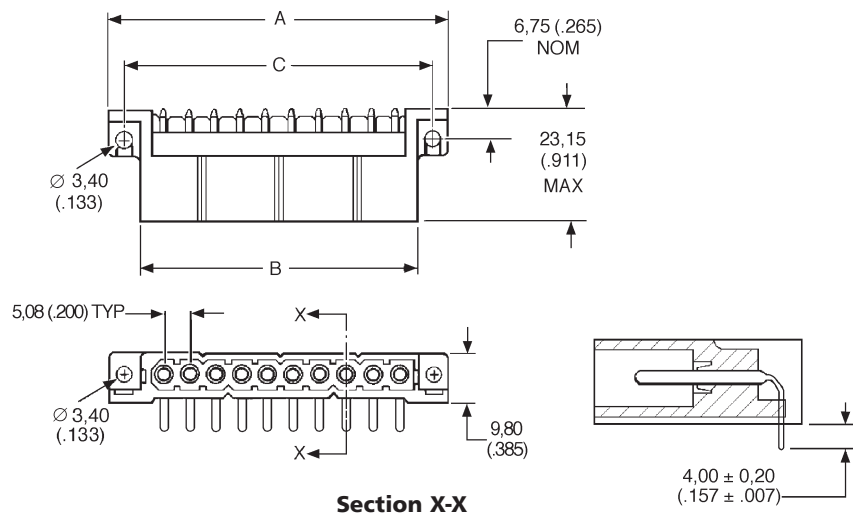

Snap Together Slimline

Part Numbers — 90° Pin Header

Number of Contacts	Gold Plated Version 0,4µm (16µin.) min. Gold		Tin Plated Version		Dimensions (max.)		
	Part Number (Pack of 100)	Nomenclature	Part Number (Pack of 100)	Nomenclature	A	B	C
3	192991-0532	TP 03 R3E 00Y	192991-0317	TST 03 RE 01T	31,40 (1.236)	19,40 (.763)	25,50 (1.003)
4	192991-0533	TP 04 R3E 00Y	192991-0319	TST 04 RE 01T	36,50 (1.437)	14,50 (.964)	30,60 (1.204)
6	192991-0534	TP 06 R3E 00Y	192991-0321	TST 06 RE 01T	46,70 (1.838)	34,70 (1.366)	40,70 (1.602)
9	192991-0535	TP 09 R3E 00Y	192991-0323	TST 09 RE 01T	61,90 (2.437)	49,90 (1.964)	56,00 (2.204)
10	192991-0538	TP 10 R3E 00Y	192991-0325	TST 10 RE 01T	67,00 (2.637)	55,00 (2.165)	61,10 (2.405)

PCB Layout

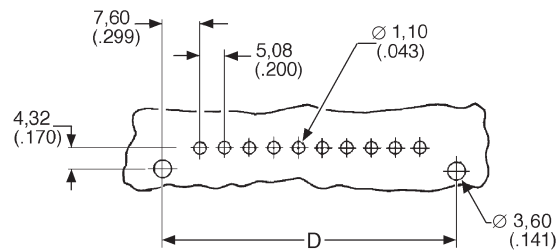

Number of Contacts	D max.
3	25,50 (1.003)
4	30,60 (1.204)
6	40,70 (1.602)
9	56,00 (2.204)
10	61,10 (2.405)

Dimensions shown in mm (inch)
Specifications and dimensions subject to change

Cannon Trident Connector System

Multi Rack & Panel Connectors

The Multiway Range has six plan forms available and offers an extremely reliable, robust and versatile connector system, in which any of the Trident signal or coaxial contacts can be used.

Applications:

- Inflight entertainment systems.
- Rail equipment.
- Test equipment.



Multiway
Rack & Panel

Product Features

- Fully tested to MIL-STD-202 and now IEC 512.
- Wide range of accessories, jacking and mounting hardware.
- Polarizing between connectors available, by contact position, use of shrouds or additional guide pin and socket sets.
- Recognized under the component program of UL Inc. and CSA.
- Complete range of contact options available, see page 47.

Performance Specifications

Temperature Range	-55°C to 125°C (-67°F to 257°F), Plastic Hood assemblies limited to 105°C (221°F)
Test Voltage	200 V ac rms for 60 seconds
Insulation Resistance	5000 MV min. at 500 V dc
Flammability	UL 94V-0 (Insulators), UL 94V-1 (Plastic Hoods)
Rated Current	Dependent on choice of contact and application (usually limited by cable bundle factor)

Materials and Finishes

Description	Material	Finish/Treatment
Insulator	Glass-Filled Phenolic	—
Intermating Hardware	Brass and Stainless Steel	—
Jackscrew Knobs	Thermoplastic	—
Cable Clamps	Stainless Steel	—
Pin Protection Shrouds, 14-34 Way	Aluminum	Anodized
Pin Protection Shrouds, 50 & 75 Way	Stainless Steel	—
Formed Hoods	Aluminum	Anodized
Plastic Hoods	Unfilled Thermoplastic - PPO	—
Die Cast Hoods	Zinc Alloy	Grey Paint

Test Data

Test Description	IEC Test	Military Standard	Test Method
Test Voltage	512-2 Test 4a	MIL-STD-202	301
Insulation Resistance	512-2 Test 3a	MIL-STD-202	302
Vibration	512-4 Test 6d	MIL-STD-202	204, Condition A
Shock	512-4 Test 6c	MIL-STD-202	213
Humidity	512-6 Test 11c	MIL-STD-202	103, Condition C
Corrosion (Salt Spray)	512-6 Test 11f	MIL-STD-202	101, Condition B
Dry Heat	512-6 Test 11i	MIL-STD-202	108A, Condition D



Dimensions shown in mm (inch)
Specifications and dimensions subject to change

www.ittcannon.com

Contact Cavity Arrangements — Mating Face View

14 Way

Plug Receptacle

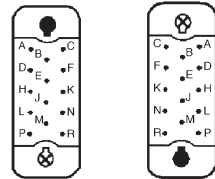

20 Way

Plug Receptacle

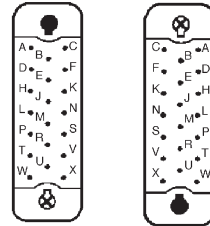

26 Way

Plug Receptacle

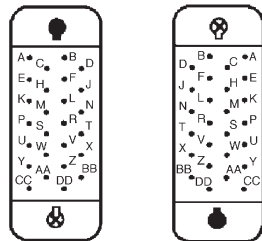

34 Way

Plug Receptacle

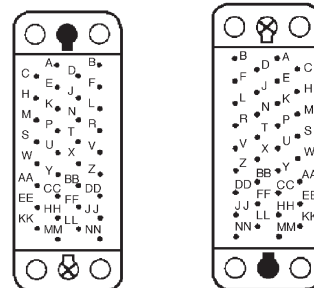

50 Way

Plug Receptacle

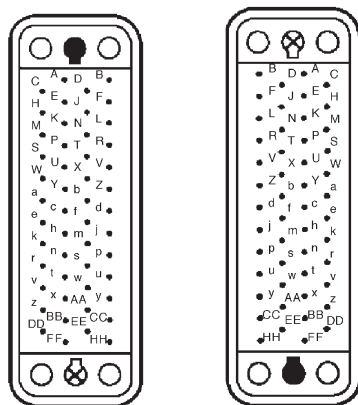

75 Way

Plug Receptacle

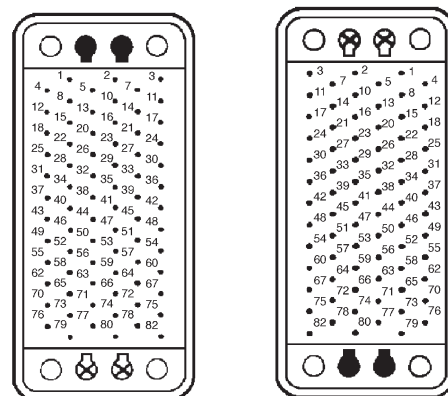

KEY

- ⊗ = Guide pin or male jack screw
- = Guide socket or female jack screw
- = Fixing holes can be fitted with additional guide pins and sockets for discrimination

Dimensions shown in mm (inch)
 Specifications and dimensions subject to change

www.ittcannon.com



Multiway Rack & Panel

How to Order

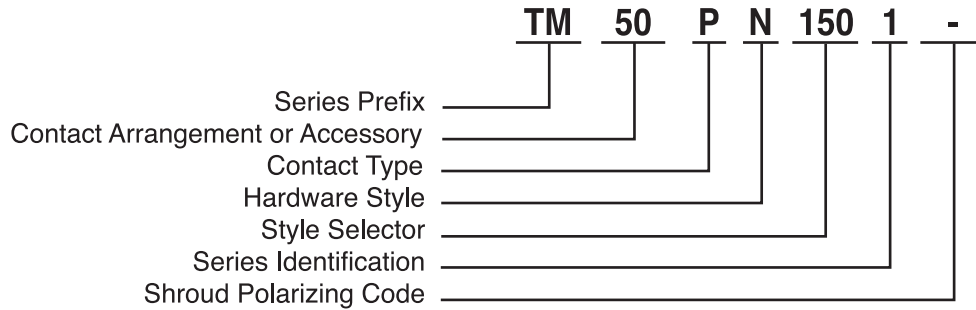

Multiway
Rack & Panel

Series Prefix

TM – Trident Multiway

Contact Arrangement or Accessory

16, 22, 28, 36, 52, 77
A – Accessory

Contact Type

P – Plug
R – Receptacle

Hardware Style

N – Normal Hardware
R – Reversed Hardware

Style Selector

See Hardware Selection Guide,
page 19.

Series Identification

1 – For all items in this
publication

Shroud Polarizing Code

leave blank, if not required.
Contact Cannon for other options.

*For more information, please
contact your local Cannon sales
office.*

Style Selector — Hardware Selection Guide

Plain, No Accessories



Note: Shown without Pin Protection Shroud.

- Specify receptacle first.

Plug or Receptacles

	Jackscrews	Guide Pins & Sockets
No Shrouds	007	001
Shrouds	207	201

Note:

1. Connectors with Jackscrews will not mate with connectors with Guide Pins or Sockets.
2. Normal Hardware: Plugs have rotating jackscrews.
3. Reversed Hardware: Receptacles have rotating hardware.

Formed Hood



Note: Shown without Pin Protection Shroud.

Plugs

	Jackscrews	Guide Pins & Sockets
No Shrouds	150	120
Shrouds	250	220

Note:

1. Connectors with Jackscrews will not mate with connectors with Guide Pins or Sockets.
2. Normal Hardware: Plugs have rotating jackscrews.
3. Reversed Hardware: Receptacles have rotating hardware.

Plastic Hood



- Jackscrews available on 34 Way only.

Plugs

	Jackscrews	Guide Pins & Sockets
No Shrouds	155	159
	(34 Way Only)	(14, 20, 26, & 34 Way Only)
Shrouds	255	259
	(34 Way Only)	(14, 20, 26, & 34 Way Only)

Note:

1. Connectors with Jackscrews will not mate with connectors with Guide Pins or Sockets.
2. Normal Hardware: Plugs have rotating jackscrews.
3. Reversed Hardware: Receptacles have rotating hardware.

Die-Cast Hood



Plugs

	Jackscrews	Guide Pins & Sockets
No Shrouds	157	N/A
	(50 & 75 Way Only)	
Shrouds	257	N/A
	(50 & 75 Way Only)	

Note:

1. Connectors with Jackscrews will not mate with connectors with Guide Pins or Sockets.
2. Normal Hardware: Plugs have rotating jackscrews.
3. Reversed Hardware: Receptacles have rotating hardware.

Straight Cable Clamp



Plugs

	Jackscrews	Guide Pins & Sockets
No Shrouds	118	180
Shrouds	218	280

Note:

1. Connectors with Jackscrews will not mate with connectors with Guide Pins or Sockets.
2. Normal Hardware: Plugs have rotating jackscrews.
3. Reversed Hardware: Receptacles have rotating hardware.

90° Cable Clamp



Plugs

	Standard Cable Exit to Left		Reversed Cable Exit to Right	
	Guide Pins		Guide Pins	
	Jackscrews & Sockets	Jackscrews & Sockets	Jackscrews & Sockets	Jackscrews & Sockets
No Shrouds	138	136	137	135
Shrouds	238	236	237	235

Note:

1. Connectors with Jackscrews will not mate with connectors with Guide Pins or Sockets.
2. Normal Hardware: Plugs have rotating jackscrews.
3. Reversed Hardware: Receptacles have rotating hardware.

Dimensions shown in mm (inch)
Specifications and dimensions subject to change

www.ittcannon.com



Multiway Rack & Panel

Ringlock is a range of robust circular connectors for industrial applications. It uses a metal bayonet coupling system for quick and reliable connections and thermoplastic bodies for low installed cost. The connectors are available in several sizes ranging from 4 to 48 circuits for signals of up to 13 A or coax. With the addition of a cable clamp, the connectors can be water sealed to meet IP65.



Applications:

- Industrial Electronics.
- Robotic Systems.
- Manufacturing Equipment.
- Printing Equipment.

Ringlock
Circular

Product Features

- Rugged metal coupling.
- Available in unsealed and sealed versions.
- Positive bayonet locking.
- Shell to shell keying.
- Integrally molded combined plastic body and insulator.
- Wide range of accessories.
- Accepts all Trident signal and coaxial contacts.
- PCB versions are available.
- Recognized under the component program of UL Inc. and CSA.

Performance Specifications

Operating Voltage	250 V ac rms
Contact Current Rating	Up to 13 A (For derating curve, see page 44)
Temperature Range	-55°C to 105°C (-67°F to 221°F)
Insulation Resistance	5000 MΩ at 500 V dc

Materials and Finishes

Description	Material	Finish
Insulator	Black Nylon, UL 94V-0	None
Coupling Ring	High Strength Copper Alloy	Nickel
Bayonet Pins	Stainless Steel	—
Bayonet Pins Support Band	High Strength Copper Alloy	Nickel

Contact Cavity Arrangements

Mating Face View, Standard Plug
(Mating Face View, Reversed Plug is mirror image)

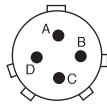

4 Way
Shell Size 10

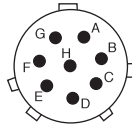

8 Way
Shell Size 12

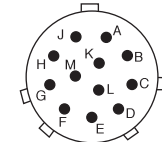

12 Way
Shell Size 14

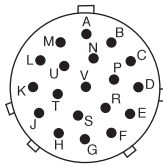

19 Way
Shell Size 16

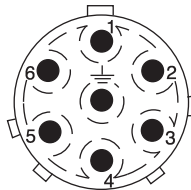

7 Way*
Shell Size 18

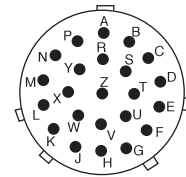

23 Way
Shell Size 18

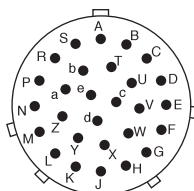

28 Way
Shell Size 20

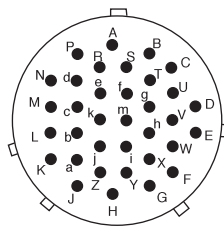

35 Way
Shell Size 22

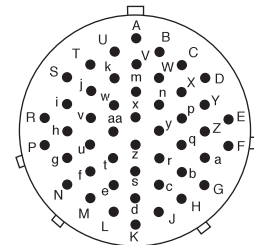

48 Way
Shell Size 24

* Meets creepage and clearance requirements for VDE 0110.

Note: The shell size indicates the diameter of the interface in sixteenths of an inch.
Example: Shell Size 16 is 1.00 inch in diameter, 25,4 mm.

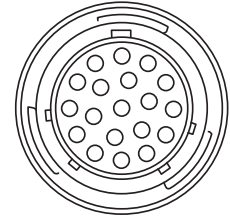
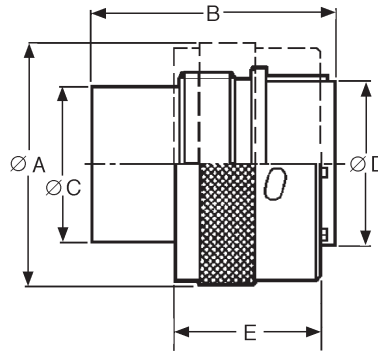

Standard Plug — Pin Contacts

- Mates with Standard Receptacles, see page 23.
- Accepts pin contacts, see page 47.
- Discriminating (Keying) Pins available, see page 52.
- Can be water sealed to IP65.

Ringlock
Circular

Number of Contacts	Shell Size	Part Number (Each)	Nomenclature	Dimensions				E	Accessory Thread
				$\varnothing A \pm 0,20 (.008)$	B max.	$\varnothing C \pm 0,15 (.005)$	$\varnothing D \pm 0,15 (.005)$		
4	10	192922-1250	TR 1004 PMS 1NB	21,60 (.850)	31,80 (1.252)	10,90 (.429)	12,20 (.480)	19,10 $\pm 0,20$ (.751 \pm .007)	9/16 - 24 UNEF
7	18	192990-1330	TR 1807 PMS 1NBE	34,30 (1.350)	33,00 (1.299)	22,50 (.885)	24,00 (.944)	19,10 $\pm 0,20$ (.751 \pm .007)	11/16 - 18 UNEF
8	12	192922-1260	TR 1208 PMS 1NB	24,80 (.976)	31,80 (1.252)	13,80 (.543)	15,10 (.594)	19,10 $\pm 0,20$ (.751 \pm .007)	11/16 - 24 UNEF
12	14	192922-1270	TR 1412 PMS 1NB	28,00 (1.102)	31,80 (1.252)	17,00 (.669)	18,30 (.720)	19,10 $\pm 0,20$ (.751 \pm .007)	13/16 - 20 UNEF
19	16	192922-1280	TR 1619 PMS 1NB	31,20 (1.228)	31,80 (1.252)	19,90 (.783)	21,40 (.842)	19,10 $\pm 0,20$ (.751 \pm .007)	15/16 - 18 UNEF
23	18	192990-1320	TR 1823 PMS 1NB	34,30 (1.350)	31,80 (1.252)	22,40 (.881)	24,00 (.944)	19,10 $\pm 0,20$ (.751 \pm .007)	11/16 - 18 UNEF
28	20	192922-1290	TR 2028 PMS 1NB	37,50 (1.476)	31,80 (1.252)	25,60 (1.007)	27,10 (1.066)	19,10 $\pm 0,20$ (.751 \pm .007)	13/16 - 20 UNEF
35	22	192922-1300	TR 2235 PMS 1NB	40,70 (1.602)	31,80 (1.252)	28,50 (1.122)	30,40 (1.196)	19,10 $\pm 0,20$ (.751 \pm .007)	15/16 - 18 UNEF
48	24	192990-1340	TR 2448 PMS 1NB	43,90 (1.728)	31,80 (1.252)	31,70 (1.248)	33,50 (1.318)	14,72 $\pm 0,15$ (.580 \pm .006)	17/16 - 18 UNEF

IMPORTANT NOTE: Standard and Reversed Format

Equipment design dictates whether the fixed connector is “live” or “dead” when disconnected. Connector housings are available that provide socket contacts on the live side of the equipment.

Standard Format: Receptacle with socket contacts.

Reversed Format: Receptacle with pin contacts.

Standard and Reversed connectors are not intermateable.



Dimensions shown in mm (inch)
Specifications and dimensions subject to change

www.ittcannon.com

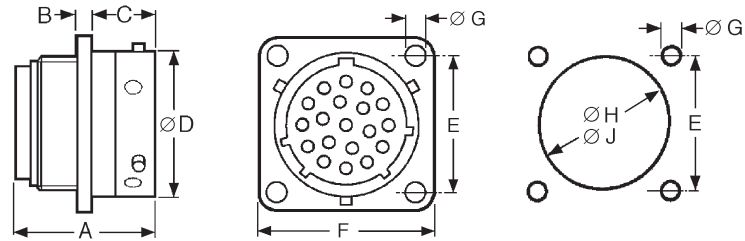

ØJ=Flange in Front of Panel
ØH= Flange at Rear of Panel

Standard Receptacle — Socket Contacts

- Mates with Standard Plugs, see page 22.
- Accepts socket contacts, see page 47.
- Printed circuit and coaxial contacts are available, see page 49.

Dimensions

Number of Contacts	Shell Size	A max.	B ± 0,15 (.005)	C ± 0,20 (.007)	ØD ± 0,15 (.005)	E ± 0,15 (.005)	F ± 0,25 (.009)	ØG ± 0,10 (.003)	ØH ± 0,10 (.003)	ØJ ± 0,10 (.003)	Accessory Thread
4	10	25,80 (1.016)	2,30 (.091)	11,15 (.439)	15,00 (.591)	18,00 (.709)	23,50 (.925)	3,25 (.128)	17,30 (.681)	15,10 (.594)	9/16 - 24 UNEF
7	18	32,50 (1.280)	2,50 (.098)	18,20 (.716)	28,50 (1.122)	27,00 (1.063)	33,30 (1.311)	3,25 (.128)	31,30 (1.232)	27,80 (1.094)	11/16 - 18 UNEF
8	12	25,80 (1.016)	2,30 (.091)	11,35 (.447)	19,00 (.748)	20,50 (.807)	26,20 (1.031)	3,25 (.128)	21,80 (.858)	18,20 (.716)	11/16 - 24 UNEF
12	14	25,80 (1.016)	2,30 (.091)	11,35 (.447)	22,20 (.874)	22,60 (.890)	28,15 (1.108)	3,25 (.128)	25,00 (.984)	21,40 (.842)	13/16 - 20 UNEF
19	16	25,80 (1.016)	2,30 (.091)	11,35 (.447)	25,40 (1.000)	24,20 (.953)	30,50 (1.200)	3,25 (.128)	28,10 (1.106)	24,60 (.968)	15/16 - 20 UNEF
23	18	25,80 (1.016)	2,50 (.098)	11,35 (.447)	28,50 (1.122)	26,90 (1.059)	33,30 (1.311)	3,25 (.128)	31,30 (1.232)	27,80 (1.094)	11/16 - 18 UNEF
28	20	33,30 (1.311)	2,50 (.098)	14,50 (.571)	31,70 (1.248)	29,20 (1.150)	36,50 (1.437)	3,25 (.128)	34,50 (1.358)	30,90 (1.216)	13/16 - 18 UNEF
35	22	33,30 (1.311)	3,50 (.138)	14,50 (.571)	34,90 (1.374)	31,60 (1.244)	39,70 (1.563)	3,25 (.128)	37,70 (1.484)	34,10 (1.342)	15/16 - 18 UNEF
48	24	33,30 (1.311)	3,50 (.138)	15,30 (.602)	38,05 (1.498)	34,45 (1.356)	42,90 (1.689)	3,90 (.154)	40,90 (1.610)	37,30 (1.468)	17/16 - 18 UNEF

Part Numbers

Number of Contacts	Shell Size	Unsealed		Sealed (see important note below)	
		Part Number (Each)	Nomenclature	Part Number (Each)	Nomenclature
4	10	192922-1190	TR 1004 RFS 1NB	192990-1660	TR 1004 RFH 1NB
7	18	192990-1300	TR 1807 RFS 1NBE	192990-1700	TR 1807 RFH 1NBE
8	12	192922-1200	TR 1208 RFS 1NB	192990-1670	TR 1208 RFH 1NB
12	14	192922-1210	TR 1412 RFS 1NB	192990-1680	TR 1412 RFH 1NB
19	16	192922-1220	TR 1619 RFS 1NB	192990-1690	TR 1619 RFH 1NB
23	18	192990-1290	TR 1823 RFS 1NB	192990-1710	TR 1823 RFH 1NB
28	20	192922-1230	TR 2028 RFS 1NB	192990-1720	TR 2028 RFH 1NB
35	22	192922-1240	TR 2235 RFS 1NB	192990-1730	TR 2235 RFH 1NB
48	24	192990-1310	TR 2448 RFS 1NB	192990-1740	TR 2448 RFH 1NB

IMPORTANT NOTE: Sealed Connectors

A sealed receptacle has an O-Ring seal that blocks moisture when the plug and receptacle are mated. However, the receptacle is not sealed in an unmated condition. For protection, dust caps are recommended for unmated receptacles, see page 24.

Plug connectors using a sealed cable clamp (see page 25) with jacketed cable will meet IP65 when mated to a sealed receptacle

Dimensions shown in mm (inch)

Specifications and dimensions subject to change

www.ittcannon.com



Ringlock Circular

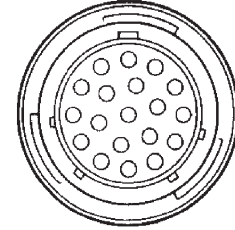
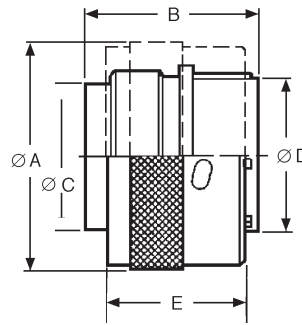

Reversed Plug — Socket Contacts

- Mates with Reversed Receptacles, see page 25.
- Accepts socket contacts, see page 47.
- Discriminating (Keying) Pins available, see page 52.
- Can be water sealed to IP65.

Ringlock
Circular

Number of Contacts	Shell Size	Part Number (Each)	Nomenclature	Dimensions					Accessory Thread
				ØA ± 0,20 (.008)	B max.	ØC ± 0,15 (.005)	ØD ± 0,15 (.005)	E	
4	10	192926-0500	TR 1004 PFS 1NB	21,60 (.850)	26,10 (1.027)	11,00 (.433)	12,20 (.480)	19,10 ±0,20 (.751 ±.007)	9/16 - 24 UNEF
7	18	192990-1390	TR 1807 PFS 1NBE	34,30 (1.350)	31,50 (1.240)	22,50 (.885)	24,00 (.944)	19,10 ±0,20 (.751 ±.007)	1-1/16 - 18 UNEF
8	12	192926-0510	TR 1208 PFS 1NB	24,80 (.976)	25,60 (1.008)	13,90 (.547)	15,10 (.594)	19,10 ±0,20 (.751 ±.007)	11/16 - 24 UNEF
12	14	192926-0520	TR 1412 PFS 1NB	28,00 (1.102)	26,80 (1.055)	17,10 (.673)	18,30 (.720)	19,10 ±0,20 (.751 ±.007)	13/16 - 20 UNEF
19	16	192926-0530	TR 1619 PFS 1NB	31,20 (1.228)	27,60 (1.087)	20,00 (.787)	21,40 (.842)	19,10 ±0,20 (.751 ±.007)	15/16 - 18 UNEF
23	18	192990-1380	TR 1823 PFS 1NB	34,30 (1.350)	25,60 (1.088)	22,50 (.885)	24,00 (.944)	19,10 ±0,20 (.751 ±.007)	1-1/16 - 18 UNEF
28	20	192926-0540	TR 2028 PFS 1NB	37,50 (1.476)	31,30 (1.232)	25,70 (1.011)	27,10 (1.066)	19,10 ±0,20 (.751 ±.007)	1-3/16 - 20 UNEF
35	22	192926-0550	TR 2235 PFS 1NB	40,70 (1.602)	31,30 (1.232)	28,60 (1.126)	30,40 (1.196)	19,10 ±0,20 (.751 ±.007)	1-5/16 - 18 UNEF
48	24	192990-1400	TR 2448 PFS 1NB	43,90 (1.728)	31,30 (1.232)	31,80 (1.225)	33,50 (1.318)	14,72 ±0,15 (.580 ±.006)	1-7/16 - 18 UNEF

IMPORTANT NOTE: Standard and Reversed Format
 Equipment design dictates whether the fixed connector is "live" or "dead" when disconnected. Connector housings are available that provide socket contacts on the live side of the equipment.

Standard Format: Receptacle with socket contacts.
 Reversed Format: Receptacle with pin contacts.

Standard and Reversed connectors are not intermateable.



Dimensions shown in mm (inch)
 Specifications and dimensions subject to change

www.ittcannon.com

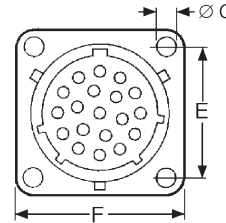
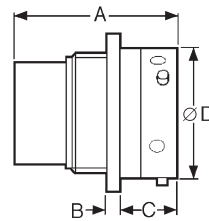

Panel Cutout

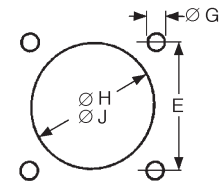

ØJ = Flange in Front of Panel
ØH = Flange at Rear of Panel

Reversed Receptacle — Pin Contacts

- Mates with Reversed Plugs, see page 24.
- Accepts pin contacts, see page 47.
- Printed Circuit and coaxial contacts are available, see page 47.

Dimensions

Number of Contacts	Shell Size	A max.	B ±0,15 (.005)	C ±0,20 (.007)	ØD ±0,15 (.005)	E ±0,15 (.005)	F ±0,25 (.009)	ØG ±0,10 (.003)	ØH ±0,10 (.003)	ØJ ±0,10 (.003)	Accessory Thread
4	10	31,50 (1.240)	2,30 (.091)	11,35 (.447)	15,00 (.591)	18,00 (.709)	23,50 (.925)	3,25 (.128)	17,30 (.681)	15,10 (.594)	9/16 - 24 UNEF
7	18	34,20 (1.346)	2,30 (.091)	17,80 (.700)	28,50 (1.122)	27,00 (1.063)	33,30 (1.311)	3,25 (.128)	31,30 (1.232)	27,80 (1.094)	1-1/16 - 18 UNEF
8	12	31,50 (1.240)	2,30 (.091)	11,35 (.447)	19,00 (.748)	20,50 (.807)	26,20 (1.031)	3,25 (.128)	21,80 (.858)	18,20 (.716)	11/16 - 24 UNEF
12	14	31,50 (1.240)	2,30 (.091)	11,35 (.447)	22,20 (.874)	22,60 (.890)	28,15 (1.108)	3,25 (.128)	25,00 (.984)	21,40 (.842)	13/16 - 20 UNEF
19	16	31,50 (1.240)	2,30 (.091)	11,35 (.447)	25,40 (1.000)	24,20 (.953)	30,50 (1.200)	3,25 (.128)	28,10 (1.106)	24,60 (.968)	15/16 - 20 UNEF
23	18	31,50 (1.240)	2,50 (.098)	11,35 (.447)	28,50 (1.122)	26,90 (1.059)	33,30 (1.311)	3,25 (.128)	31,30 (1.232)	27,80 (1.094)	1-1/16 - 18 UNEF
28	20	33,00 (1.299)	2,50 (.098)	14,55 (.573)	31,70 (1.248)	29,20 (1.150)	36,50 (1.437)	3,25 (.128)	34,50 (1.358)	30,90 (1.216)	1-3/16 - 18 UNEF
35	22	33,00 (1.299)	3,50 (.138)	14,55 (.573)	34,90 (1.374)	31,60 (1.244)	39,70 (1.563)	3,25 (.128)	37,70 (1.484)	34,10 (1.342)	1-5/16 - 18 UNEF
48	24	34,80 (1.370)	3,50 (.138)	15,35 (.604)	38,05 (1.498)	34,45 (1.356)	42,90 (1.689)	3,90 (.154)	40,90 (1.610)	37,30 (1.468)	1-7/16 - 18 UNEF

Part Numbers

Number of Contacts	Shell Size	Unsealed		Sealed (see important note below)	
		Part Number (Each)	Nomenclature	Part Number (Each)	Nomenclature
4	10	192926-0440	TR 1004 RMS 1NB	192990-1760	TR 1004 RMH 1NB
7	18	192990-1360	TR 1807 RMS 1NBE	192990-1800	TR 1807 RMH 1NBE
8	12	192926-0450	TR 1208 RMS 1NB	192990-1770	TR 1208 RMH 1NB
12	14	192926-0460	TR 1412 RMS 1NB	192990-1780	TR 1412 RMH 1NB
19	16	192926-0470	TR 1619 RMS 1NB	192990-1790	TR 1619 RMH 1NB
23	18	192990-1350	TR 1823 RMS 1NB	192990-1810	TR 1823 RMH 1NB
28	20	192926-0480	TR 2028 RMS 1NB	192990-1820	TR 2028 RMH 1NB
35	22	192926-0490	TR 2235 RMS 1NB	192990-1830	TR 2235 RMH 1NB
48	24	192990-1370	TR 2448 RMS 1NB	192990-1840	TR 2448 RMH 1NB

IMPORTANT NOTE: Sealed Connectors

A sealed receptacle has an O-Ring seal that blocks moisture when the plug and receptacle are mated. However, the receptacle is not sealed in an unmated condition. For protection, dust caps are recommended for unmated receptacles, see page 24.

Plug connectors using a sealed cable clamp (see page 25) with jacketed cable will meet IP65 when mated to a sealed receptacle.

Dimensions shown in mm (inch)

Specifications and dimensions subject to change

www.ittcannon.com



Ringlock Circular

Cannon Trident Connector System

Ringlock Circular Connectors

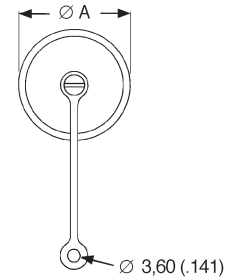
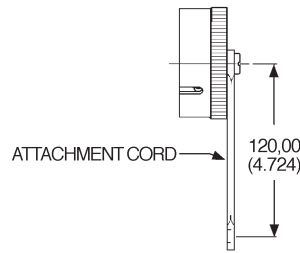

Plastic Dust Caps for Receptacles

- Protects unmated receptacles.
- Durable construction for long-term use.
- For use with Ringlock receptacles.

Shell Size	Part Number (Each)	Part Number (Pack of 100)	Dimension Ø A max.
10	192900-0666	192900-0676	21,80 (.858)
12	192900-0667	192900-0677	25,40 (1.000)
14	192900-0668	192900-0678	28,60 (1.126)
16	192900-0669	192900-0679	31,70 (1.248)
18	192900-0670	192900-0680	34,90 (1.374)
20	192900-0671	192900-0681	38,10 (1.500)
22	192900-0672	192900-0682	41,20 (1.622)
24	192900-0673	192900-0683	44,40 (1.748)

Ringlock
Circular

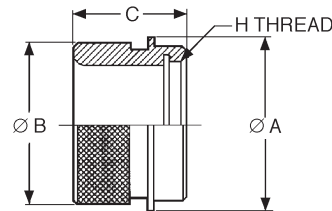

Adapters for Heat Shrink Boots or Sleeving

Shell Size	Part Number (Each)	Nomenclature	ØA max.	ØB max.	C max.	H Thread
10	192990-1430	TR 10 AAD	21,00 (.827)	18,10 (.712)	19,20 (.755)	9/16 - 24 UNEF-2B
12	192990-1440	TR 12 AAD	24,00 (.944)	23,40 (.921)	19,20 (.755)	11/16 - 24 UNEF-2B
14	192990-1450	TR 14 AAD	27,00 (1.063)	24,20 (.952)	19,20 (.755)	13/16 - 20 UNEF-2B
16	192990-1460	TR 16 AAD	30,20 (1.189)	29,60 (1.165)	21,50 (.846)	15/16 - 20 UNEF-2B
18	192990-1470	TR 18 AAD	33,30 (1.311)	31,70 (1.248)	21,50 (.846)	11/16 - 18 UNEF-2B
20	192990-1480	TR 20 AAD	36,50 (1.437)	35,80 (1.409)	22,80 (.897)	13/16 - 18 UNEF-2B
22	192990-1490	TR 22 AAD	39,70 (1.563)	38,20 (1.503)	22,80 (.897)	15/16 - 18 UNEF-2B
24	192990-1500	TR 24 AAD	42,90 (1.689)	41,30 (1.626)	21,90 (.862)	17/16 - 18 UNEF-2B



Panel Gaskets For Ringlock Receptacle Connectors

- All panel gaskets are 1,50 (.059) thick.

Shell Size	Part Number (Pack of 100)
10	075-8543-011
12	075-8543-012
14	192900-0565
16	192900-0566
18	075-8543-015
20	192991-0566
22	075-8543-017
24	192900-0567



Dimensions shown in mm (inch)
Specifications and dimensions subject to change

www.ittcannon.com



Sealed Cable Clamps for Use With Ringlock Circular Connectors

- For use with jacketed cables.
- Provides strain relief and wire protection.
- Can be water sealed to IP65. See notes on pages 22 and 24.
- For assembly instructions, see page 56.

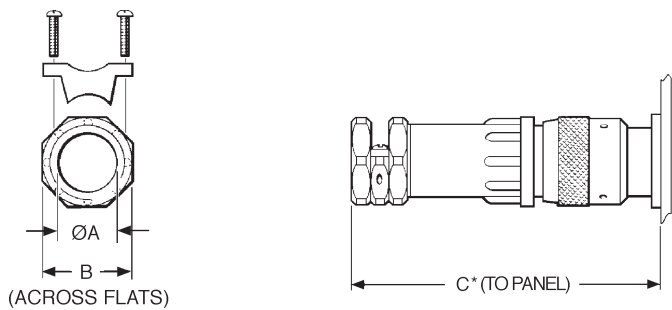

* For disassembly, add 9,00 (.354) for Shell Sizes 10-16 & add 10,60 (.417) for Shell Sizes 18-24.

Shell Size	Part Number (Each)	Nomenclature	Ø A max.	B ± 0,20 (.007)	C* max.
10	192990-1530	TR 10 AHC 1N	11,10 (.437)	18,80 (.740)	76,50 (3.011)
12	192990-1540	TR 12 AHC 1N	13,60 (.535)	20,80 (.818)	77,80 (3.063)
14	192990-1550	TR 14 AHC 1N	14,60 (.574)	22,80 (.897)	85,50 (3.366)
16	192990-1560	TR 16 AHC 1N	16,60 (.653)	24,70 (.972)	89,80 (3.535)
18	192990-1570	TR 18 AHC 1N	16,60 (.653)	24,70 (.972)	93,00 (3.661)
20	192990-1580	TR 20 AHC 1N	22,10 (.870)	31,80 (1.252)	107,50 (4.232)
22	192990-1590	TR 22 AHC 1N	22,10 (.870)	31,80 (1.252)	114,50 (4.507)
24	192990-1600	TR 24 AHC 1N	29,60 (1.165)	41,80 (1.645)	128,50 (5.059)

* Assumes a uniformly cylindrical cable. Variations in the diameter could effect sealing.



Unsealed Cable Clamps For Use With Ringlock Circular Connectors

- Provides strain relief and wire protection.
- For assembly instructions, see page 59.

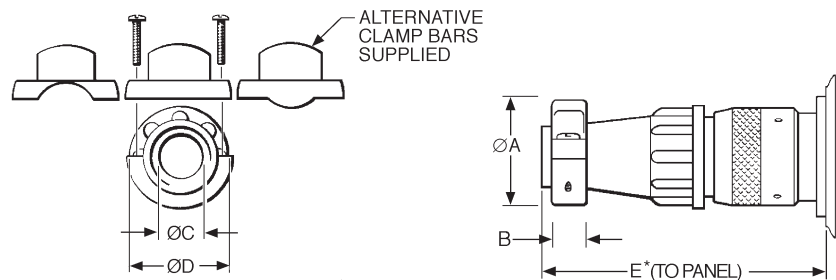

* For disassembly, add 9,00 (.354) for Shell Sizes 10-16 & add 10,60 (.417) for Shell Sizes 18-24.

Shell Size	Part Number (Each)	Nomenclature	Ø A max.	B ± 0,15 (.005)	Ø C max.	Ø D ± 0,15 (.005)	E* max.
10	192922-1310	TR 10 ASR 1N	21,50 (.846)	6,40 (.251)	8,70 (.342)	21,00 (.826)	61,30 (2.413)
12	192922-1320	TR 12 ASR 1N	24,90 (.980)	6,40 (.251)	12,80 (.503)	24,00 (.944)	61,30 (2.413)
14	192922-1330	TR 14 ASR 1N	27,00 (1.063)	6,40 (.251)	13,80 (.543)	27,00 (1.063)	67,10 (2.641)
16	192922-1340	TR 16 ASR 1N	30,10 (1.185)	6,40 (.251)	17,00 (.669)	30,20 (1.189)	67,10 (2.641)
18	192990-1510	TR 18 ASR 1N	32,00 (1.259)	7,00 (.275)	19,90 (.783)	33,20 (1.307)	70,80 (2.787)
20	192922-1350	TR 20 ASR 1N	34,30 (1.350)	7,00 (.275)	21,00 (.827)	36,40 (1.433)	79,30 (3.122)
22	192922-1360	TR 22 ASR 1N	37,10 (1.460)	8,20 (.322)	23,00 (.905)	39,60 (1.559)	85,30 (3.358)
24	192990-1520	TR 24 ASR 1N	41,80 (1.645)	8,20 (.322)	27,00 (1.063)	42,80 (1.685)	90,80 (3.574)

Dimensions shown in mm (inch)
Specifications and dimensions subject to change

www.ittcannon.com



Ringlock Circular

Neptune is a range of circular connectors specifically designed for harsh environment applications. They come with membrane wire seals that meet the requirements for IP67 and do not require blanking plugs for unused cavities. They will accept various combinations of signal (13 A) and power (30 A) contacts. The receptacle connectors feature stainless steel bayonet pins integrally molded into the bodies. The plug connectors are available with either high strength metal or corrosion resistant plastic coupling rings.

Applications

- Off Road Vehicles.
- Truck and Bus.
- Agricultural Equipment.
- Construction Equipment.
- Outdoor Electronics



Product Features

- Mixes signal and 30 A power contacts in one housing.
- Printed circuit and coaxial contacts available.
- Full interface and cable sealing up to IP67.
- Large range support accessories.
- Robust, cost effective connector for harsh environments.

Performance Specifications

Temperature Range	-55°C to 105°C (-67°F to 221°F)
Test Voltage	2000 V ac rms
Working Voltage	25 V (Can be higher, if the equipment safety will allow)
Insulation Resistance	5000 MΩ at 500 V dc
Environmental Sealing	Up to IP67
Flammability	UL 94V-0

Materials and Finishes

Description	Material	Finish
Insulator	Black Nylon, UL 94V-0	None
Bayonet Pin	Stainless Steel	None
Bayonet Pin Support Band	High Strength Copper Alloy	Nickel
Coupling Ring	High Strength Copper Alloy	Nickel

Contact Cavity Arrangements

Neptune Circular Connectors offer combinations of signal and power contacts.

The Signal cavities will accept any of the standard Trident contacts, including signal contacts up to 13 A and coax. The power cavities will accept power contacts rated at 30 A. PCB contacts are also available, for more information see page 47.

Mating Face Views of Reversed and Standard Receptacles.

* The 0-12 view is of reversed receptacle only
(0-12 standard receptacle is mirror image)

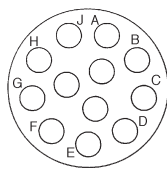

0-12*
Shell Size 14
12 Signal
0 Power

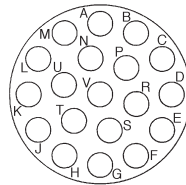

0-19
Shell Size 16
19 Signal
0 Power

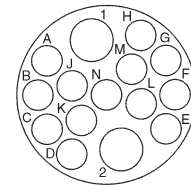

2-13
Shell Size 16
13 Signal
2 Power

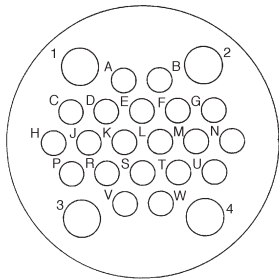

4-20
Shell Size 24
20 Signal
4 Power

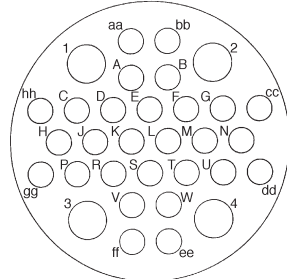

4-28
Shell Size 24
28 Signal
4 Power

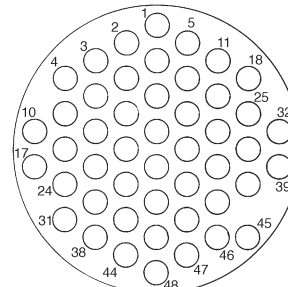

0-48
Shell Size 24
48 Signal
0 Power

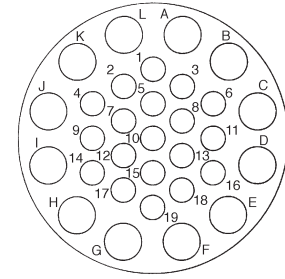

12-19
Shell Size 24
19 Signal
12 Power

Note: The shell size indicates the diameter of the interface in sixteenths of an inch.
Example: Shell Size 16 is 1.00 inch in diameter, 25,4 mm.

Wire Sealing Range

Contact Arrangement	Signal (Overall Diameter)	Power (Overall Diameter)
0-12	1,70-2,70 (.066-.106)	N/A
0-19	1,70-2,70 (.066-.106)	N/A
2-13	1,70-2,70 (.066-.106)	2,70-4,00 (.106-.157)
4-20	1,70-2,70 (.066-.106)	2,70-4,00 (.106-.157)
4-28	1,70-2,70 (.066-.106)	2,70-4,00 (.106-.157)
0-48	1,70-2,20 (.066-.086)	N/A
0-48 (L)	2,30-3,20 (.090-.126)	N/A
12-19	1,70-2,70 (.066-.106)	2,70-4,00 (.106-.157)

(L) Larger overall sealing diameter for thick insulation wires.

Cannon Trident Connector System

Neptune Circular Connectors

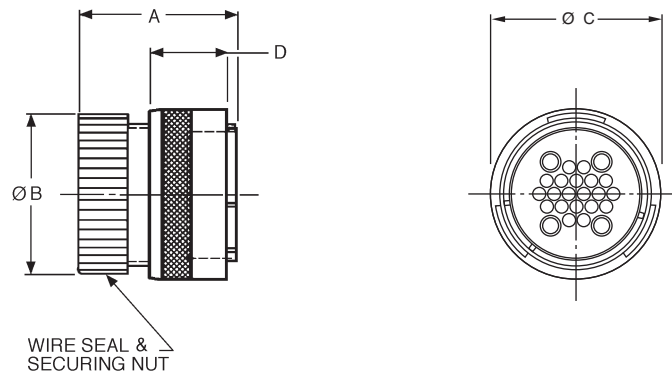

Standard Plugs — Pin Contacts Metal Locking Ring

- For Wire Sealing Ranges, see page 29.
- Accepts pin contacts, see page 47.
- Water sealed to IP67.
- Bulk packaging options available. Contact Cannon for details.

Contact

Layout	Shell Size	Part Number	Nomenclature	A	ØB	ØC	D
4-20	24	192900-0014	TN 6S 2404-20 P1L	39,80 (1.566)	40,50 (1.594)	44,00 (1.732)	14,72 ±0,15 (.580 ±.006)
4-28	24	192900-0015	TN 6S 2404-28 P1L	39,80 (1.566)	40,50 (1.594)	44,00 (1.732)	14,72 ±0,15 (.580 ±.006)
12-19	24	192900-0016	TN 6S 2412-19 P1L	39,80 (1.566)	40,50 (1.594)	44,00 (1.732)	14,72 ±0,15 (.580 ±.006)
0-48	24	192900-0469	TN 6S 2400-48 P1L	39,80 (1.566)	40,50 (1.594)	44,00 (1.732)	14,72 ±0,15 (.580 ±.006)
0-48 (L)	24	192991-0628	TN 6L 2400-48 P1L	50,70 (2.000)	40,50 (1.594)	44,00 (1.732)	14,72 ±0,15 (.580 ±.006)
0-19	16	192900-0017	TN 6S 1600-19 P1L	39,80 (1.566)	27,00 (1.063)	30,20 (1.189)	19,10 ±0,20 (.751 ±.007)
2-13	16	192900-0507	TN 6S 1602-13 P1L	39,80 (1.566)	27,00 (1.063)	30,20 (1.189)	19,10 ±0,20 (.751 ±.007)
0-12	14	192900-0303	TN 6S 1400-12 P1L	38,80 (1.527)	24,30 (.957)	28,00 (1.102)	19,10 ±0,20 (.751 ±.007)

(L) Larger overall sealing diameter for thick insulation wires.

Neptune
Circular

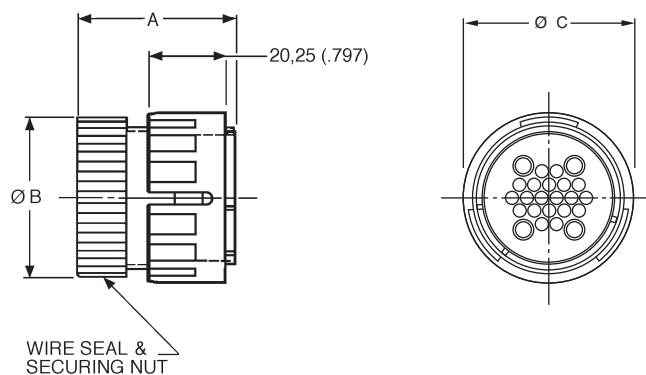

Plastic Locking Ring

- For Wire Sealing Ranges, see page 29.
- Accepts pin contacts, see page 47.
- Water sealed to IP67.
- Bulk packaging options available. Contact Cannon for details.

Contact

Layout	Shell Size	Part Number	Nomenclature	A	ØB	ØC
4-20	24	192900-0537	TN 6S2404-20 P2L	39,80 (1.566)	40,50 (1.594)	45,75 (1.800)
4-28	24	192900-0549	TN 6S2404-28 P2L	39,80 (1.566)	40,50 (1.594)	45,75 (1.800)
12-19	24	192900-0538	TN 6S2412-19 P2L	39,80 (1.566)	40,50 (1.594)	45,75 (1.800)
0-48	24	192900-0539	TN 6S2400-48 P2L	39,80 (1.566)	40,50 (1.594)	45,75 (1.800)
0-48 (L)	24	192991-0660	TN 6L2400-48 P2L	50,70 (2.000)	40,50 (1.594)	45,75 (1.800)
0-19	16	192900-0557	TN 6S1600-19 P2L	39,80 (1.566)	27,00 (1.063)	32,80 (1.291)
2-13	16	192900-0561	TN 6S1602-13 P2L	39,80 (1.566)	27,00 (1.063)	32,80 (1.291)

(L) Larger overall sealing diameter for thick insulation wires.

Dimensions are shown in mm (inch)
Dimensions subject to change



Dimensions shown in mm (inch)
Specifications and dimensions subject to change

www.ittcannon.com

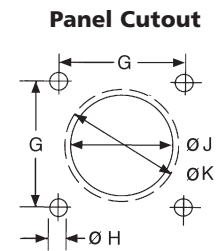
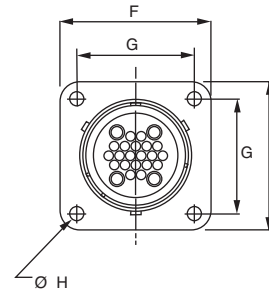
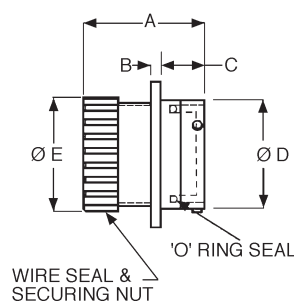

ØJ = Flange in Front of Panel
ØK = Flange at Rear of Panel

Standard Receptacles — Socket Contacts Flange Mounting

- For Wire Sealing Ranges, see page 29.
- For Panel Gaskets, see page 37.
- Receptacle may be ordered without securing nut and wire seal. Contact Cannon for details.
- Bulk packaging options available. Contact Cannon for details.

Contact Shell

Layout	Size	Part Number	Nomenclature	A	B	C	ØD	ØE	F	G	ØH	ØJ	ØK
4-20	24	192900-0030	TN OS 2404-20 S1L	41,80 (1.645)	3,50 (.137)	15,40 (.606)	38,10 (1.500)	40,10 (1.578)	50,80 (2.000)	39,70 (1.563)	4,20 (.165)	41,00 (1.614)	41,00 (1.614)
4-28	24	192900-0033	TN OS 2404-28 S1L	41,80 (1.645)	3,50 (.137)	15,40 (.606)	38,10 (1.500)	40,10 (1.578)	50,80 (2.000)	39,70 (1.563)	4,20 (.165)	41,00 (1.614)	41,00 (1.614)
12-19	24	192900-0036	TN OS 2412-19 S1L	41,80 (1.645)	3,50 (.137)	15,40 (.606)	38,10 (1.500)	40,10 (1.578)	50,80 (2.000)	39,70 (1.563)	4,20 (.165)	41,00 (1.614)	41,00 (1.614)
0-48	24	192900-0475	TN OS 2400-48 S1L	41,80 (1.645)	3,50 (.137)	15,40 (.606)	38,10 (1.500)	40,10 (1.578)	50,80 (2.000)	39,70 (1.563)	4,20 (.165)	41,00 (1.614)	41,00 (1.614)
0-48 (L)	24	192991-0640	TN OL 2400-48 S1L	52,70 (2.075)	3,50 (.137)	15,40 (.606)	38,10 (1.500)	40,10 (1.578)	50,80 (2.000)	39,70 (1.563)	4,20 (.165)	41,00 (1.614)	41,00 (1.614)
0-19	16	192900-0039	TN OS 1600-19 S1L	39,80 (1.566)	2,30 (.090)	11,40 (.448)	25,40 (1.000)	27,00 (1.063)	31,00 (1.220)	24,50 (.964)	3,20 (.125)	28,10 (1.106)	28,10 (1.106)
2-13	16	192900-0509	TN OS 1602-13 S1L	39,80 (1.566)	2,30 (.090)	11,40 (.448)	25,40 (1.000)	27,00 (1.063)	31,00 (1.220)	24,50 (.964)	3,20 (.125)	28,10 (1.106)	28,10 (1.106)
0-12	14	192900-0308	TN OS 1400-12 S1L	39,70 (1.563)	2,30 (.090)	11,40 (.448)	22,20 (.874)	24,30 (.956)	28,60 (1.122)	22,90 (.901)	3,20 (.125)	24,60 (.968)	24,60 (.968)

(L) Larger overall sealing diameter for thick insulation wires.

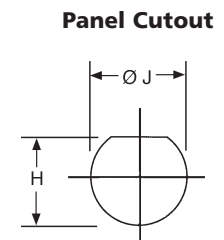
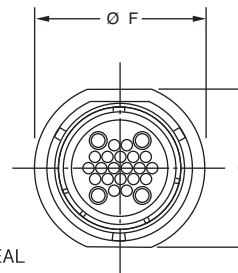
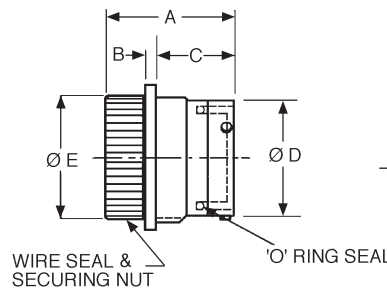

Jam Nut Mounting

- Jam Nut included.
- For Wire Sealing Ranges, see page 29.
- For Panel Gaskets, see page 35.
- Receptacle may be ordered without securing nut and wire seal. Contact Cannon for details.
- Bulk packaging options available. Contact Cannon for details.

Contact Shell

Layout	Size	Part Number	Nomenclature	A	B	C	ØD	ØE	ØF	G	H	ØJ
4-20	24	192900-0032	TN 7S 240420 S1L	41,80 (1.645)	3,50 (.137)	23,40 (.921)	38,10 (1.500)	40,10 (1.578)	51,00 (2.007)	47,50 (1.870)	41,50 (1.633)	43,20 (1.700)
4-28	24	192900-0035	TN 7S 240428 S1L	41,80 (1.645)	3,50 (.137)	23,40 (.921)	38,10 (1.500)	40,10 (1.578)	51,00 (2.007)	47,50 (1.870)	41,50 (1.633)	43,20 (1.700)
12-19	24	192900-0038	TN 7S 241219 S1L	41,80 (1.645)	3,50 (.137)	23,40 (.921)	38,10 (1.500)	40,10 (1.578)	51,00 (2.007)	47,50 (1.870)	41,50 (1.633)	43,20 (1.700)
0-48	24	192900-0481	TN 7S 240048 S1L	41,80 (1.645)	3,50 (.137)	23,40 (.921)	38,10 (1.500)	40,10 (1.578)	51,00 (2.007)	47,50 (1.870)	41,50 (1.633)	43,20 (1.700)
0-48 (L)	24	192991-0644	TN 7L 240048 S1L	52,70 (2.075)	3,50 (.137)	23,40 (.921)	38,10 (1.500)	40,10 (1.578)	51,00 (2.007)	47,50 (1.870)	41,50 (1.633)	43,20 (1.700)
0-19	16	192900-0490	TN 7S 160019 S1L	39,80 (1.566)	2,30 (.090)	23,00 (.905)	25,40 (1.000)	27,00 (1.063)	39,80 (1.566)	38,40 (1.511)	28,00 (1.102)	30,50 (1.200)
2-13	16	192900-0508	TN 7S 160213 S1L	39,80 (1.566)	2,30 (.090)	23,00 (.905)	25,40 (1.000)	27,00 (1.063)	39,80 (1.566)	38,40 (1.511)	28,00 (1.102)	30,50 (1.200)
0-12	14	192900-0313	TN 7S 140012 S1L	39,70 (1.563)	3,50 (.137)	22,10 (.870)	22,20 (.874)	24,30 (.956)	35,80 (1.409)	32,20 (1.267)	25,10 (.988)	27,30 (1.075)

(L) Larger overall sealing diameter for thick insulation wires.

Dimensions shown in mm (inch)
 Specifications and dimensions subject to change

www.ittcannon.com



Cannon Trident Connector System

Neptune Circular Connectors

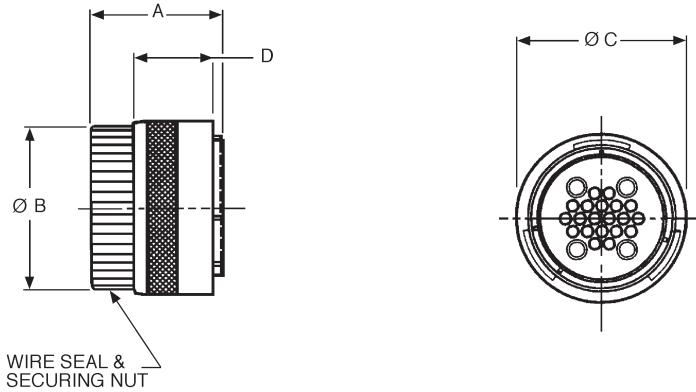

Reversed Plugs — Socket Contacts Metal Locking Ring

- For Wire Sealing Ranges, see page 29.
- Accepts socket contacts, see page 47.
- Water sealed to IP67.
- Bulk packaging options available. Contact Cannon for details.

Contact Layout	Shell Size	Part Number	Nomenclature	A	Ø B	Ø C	D
4-20	24	192900-0054	TN 6S 240420 S1L	32,40 (1.275)	40,50 (1.594)	44,00 (1.732)	14,72 ±0,15 (.580 ±.006)
4-28	24	192900-0055	TN 6S 240428 S1L	32,40 (1.275)	40,50 (1.594)	44,00 (1.732)	14,72 ±0,15 (.580 ±.006)
12-19	24	192900-0056	TN 6S 241219 S1L	32,40 (1.275)	40,50 (1.594)	44,00 (1.732)	14,72 ±0,15 (.580 ±.006)
0-48	24	192900-0425	TN 6S 240048 S1L	32,40 (1.275)	40,50 (1.594)	44,00 (1.732)	14,72 ±0,15 (.580 ±.006)
0-48 (L)	24	192991-0648	TN 6SL 240048 S1L	43,00 (1.693)	40,50 (1.594)	44,00 (1.732)	14,72 ±0,15 (.580 ±.006)
0-19	16	192900-0057	TN 6S 160019 S1L	31,70 (1.248)	27,00 (1.063)	30,20 (1.189)	19,10 ±0,20 (.751 ±.007)
2-13	16	192900-0581	TN 6S 160213 S1L	31,70 (1.248)	27,00 (1.063)	30,20 (1.189)	19,10 ±0,20 (.751 ±.007)
0-12	14	192900-0236	TN 6S 140012 S1L	31,60 (1.244)	24,30 (.957)	28,00 (1.102)	19,10 ±0,20 (.751 ±.007)

(L) Larger overall sealing diameter for thick insulation wires.

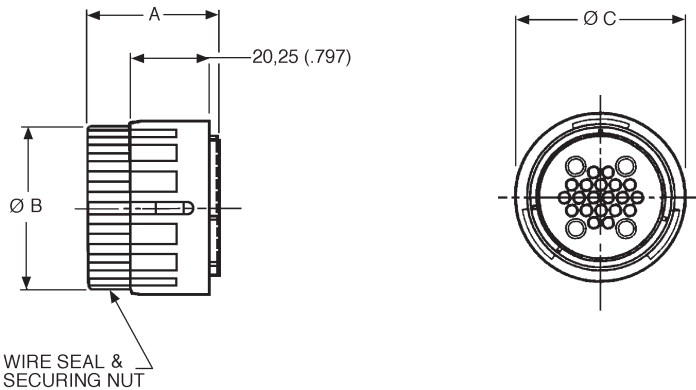

Plastic Locking Ring

- For Wire Sealing Ranges, see page 29.
- Accepts socket contacts, see page 47.
- Water sealed to IP67.
- Bulk packaging options available. Contact Cannon for details.

Contact Layout	Shell Size	Part Number	Nomenclature	A	Ø B	Ø C
4-20	24	192900-0540	TN 6S 2404-20S 2L	32,40 (1.275)	40,50 (1.594)	44,00 (1.732)
4-28	24	192900-0550	TN 6S 2404-28S 2L	32,40 (1.275)	40,50 (1.594)	44,00 (1.732)
12-19	24	192900-0541	TN 6S 2412-19S 2L	32,40 (1.275)	40,50 (1.594)	44,00 (1.732)
0-48	24	192900-0542	TN 6S 2400-48S 2L	32,40 (1.275)	40,50 (1.594)	44,00 (1.732)
0-48 (L)	24	192991-0664	TN 6L 2400-48S 2L	43,00 (1.693)	40,50 (1.594)	44,00 (1.732)
0-19	16	192900-0558	TN 6S 1600-19S 2L	31,70 (1.248)	27,00 (1.063)	32,80 (1.291)
2-13	16	192900-0562	TN 6S 1602-13S 2L	31,70 (1.248)	27,00 (1.063)	32,80 (1.291)

(L) Larger overall sealing diameter for thick insulation wires.



Dimensions shown in mm (inch)
Specifications and dimensions subject to change

www.ittcannon.com



Reversed Receptacles — Pin Contacts Flange Mounting

- For Wire Sealing Ranges, see page 29.
- For Panel Gaskets, see page 37.
- Receptacle may be ordered without securing nut and wire seal. Contact Cannon for details.
- Bulk packaging options available. Contact Cannon for details.

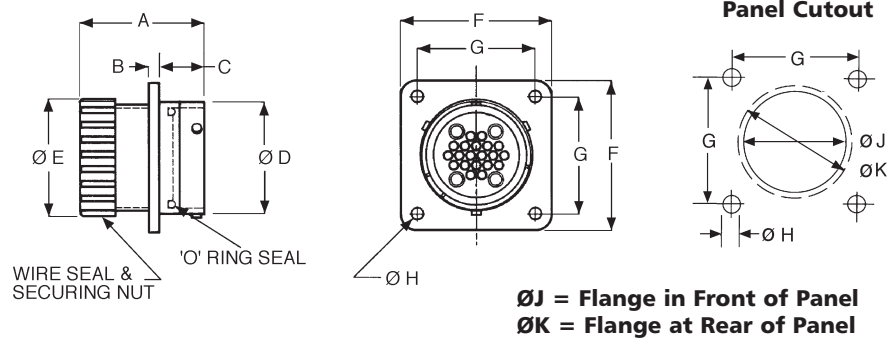

Contact Shell

Layout	Size	Part Number	Nomenclature	A	B	C	Ø D	Ø E	F	G	Ø H	Ø J	Ø K
4-20	24	192900-0069	TN OS 2404-20 P1L	41,80 (1.645)	3,50 (.137)	15,40 (.606)	38,10 (1.500)	40,10 (1.578)	50,80 (2.000)	39,70 (1.563)	4,20 (.165)	41,00 (1.614)	41,00 (1.614)
4-28	24	192900-0072	TN OS 2404-28 P1L	41,80 (1.645)	3,50 (.137)	15,40 (.606)	38,10 (1.500)	40,10 (1.578)	50,80 (2.000)	39,70 (1.563)	4,20 (.165)	41,00 (1.614)	41,00 (1.614)
12-19	24	192900-0075	TN SO 2412-19 P1L	41,80 (1.645)	3,50 (.137)	15,40 (.606)	38,10 (1.500)	40,10 (1.578)	50,80 (2.000)	39,70 (1.563)	4,20 (.165)	41,00 (1.614)	41,00 (1.614)
0-48	24	192900-0431	TN OS 2400-48 P1L	41,80 (1.645)	3,50 (.137)	15,40 (.606)	38,10 (1.500)	40,10 (1.578)	50,80 (2.000)	39,70 (1.563)	4,20 (.165)	41,00 (1.614)	41,00 (1.614)
0-48 (L)	24	192991-0652	TN OL 2400-48 P1L	52,70 (2.075)	3,50 (.137)	15,40 (.606)	38,10 (1.500)	40,10 (1.578)	50,80 (2.000)	39,70 (1.563)	4,20 (.165)	41,00 (1.614)	41,00 (1.614)
0-19	16	192900-0078	TN OS 1600-19 P1L	39,80 (1.566)	2,30 (.090)	11,40 (.448)	25,40 (1.000)	27,00 (1.063)	31,00 (1.220)	24,50 (.964)	3,20 (.125)	28,10 (1.106)	28,10 (1.106)
2-13	16	192900-0582	TN OS 1602-13 P1L	39,80 (1.566)	2,30 (.090)	11,40 (.448)	25,40 (1.000)	27,00 (1.063)	31,00 (1.220)	24,50 (.964)	3,20 (.125)	28,10 (1.106)	28,10 (1.106)
0-12	14	192900-0256	TN OS 1400-12 P1L	39,70 (1.563)	2,30 (.090)	11,40 (.448)	22,20 (.874)	24,30 (.956)	28,60 (1.122)	22,90 (.901)	3,20 (.125)	24,60 (.968)	24,60 (.968)

(L) Larger overall sealing diameter for thick insulation wires.



Jam Nut Mounting

- Jam Nut included.
- For Wire Sealing Ranges, see page 29.
- For Panel Gaskets, see page 37.
- Receptacle may be ordered without securing nut and wire seal. Contact Cannon for details.
- Bulk packaging options available. Contact Cannon for details.

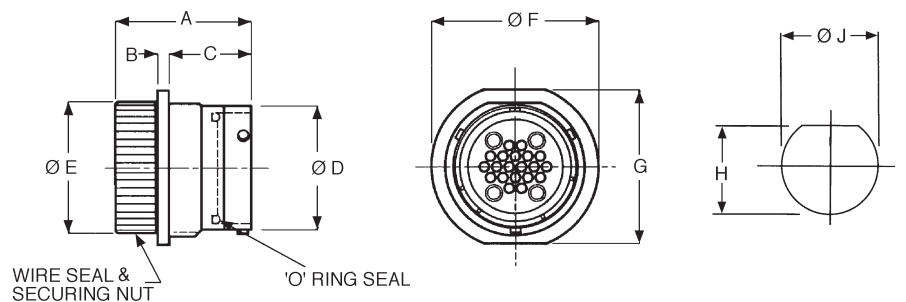

Contact Shell

Layout	Size	Part Number	Nomenclature	A	B	C	Ø D	Ø E	Ø F	G	H	Ø J
4-20	24	192900-0071	TN 7S 240420 P1L	41,80 (1.645)	3,50 (.137)	23,40 (.921)	38,10 (1.500)	40,10 (1.578)	51,00 (2.007)	47,50 (1.870)	41,50 (1.633)	43,20 (1.700)
4-28	24	192900-0074	TN 7S 240428 P1L	41,80 (1.645)	3,50 (.137)	23,40 (.921)	38,10 (1.500)	40,10 (1.578)	51,00 (2.007)	47,50 (1.870)	41,50 (1.633)	43,20 (1.700)
12-19	24	192900-0077	TN 7S 241219 P1L	41,80 (1.645)	3,50 (.137)	23,40 (.921)	38,10 (1.500)	40,10 (1.578)	51,00 (2.007)	47,50 (1.870)	41,50 (1.633)	43,20 (1.700)
0-48	24	192900-0437	TN 7S 240048 P1L	41,80 (1.645)	3,50 (.137)	23,40 (.921)	38,10 (1.500)	40,10 (1.578)	51,00 (2.007)	47,50 (1.870)	41,50 (1.633)	43,20 (1.700)
0-48 (L)	24	192991-0656	TN 7L 240048 P1L	52,70 (2.075)	3,50 (.137)	23,40 (.921)	38,10 (1.500)	40,10 (1.578)	51,00 (2.007)	47,50 (1.870)	41,50 (1.633)	43,20 (1.700)
0-19	16	192900-0353	TN 7S 160019 P1L	39,80 (1.566)	2,30 (.090)	23,00 (.905)	25,40 (1.000)	27,00 (1.063)	30,80 (1.212)	38,20 (1.503)	28,00 (1.102)	30,50 (1.200)
2-13	16	192900-0583	TN 7S 160213 P1L	39,80 (1.566)	2,30 (.090)	23,00 (.905)	25,40 (1.000)	27,00 (1.063)	30,80 (1.212)	38,20 (1.503)	28,00 (1.102)	30,50 (1.200)
0-12	14	192900-0266	TN 7S 140012 P1L	39,70 (1.563)	2,30 (.137)	22,10 (.870)	22,20 (.874)	24,30 (.956)	35,80 (1.409)	32,20 (1.267)	25,10 (.988)	27,30 (1.075)

(L) Larger overall sealing diameter for thick insulation wires.

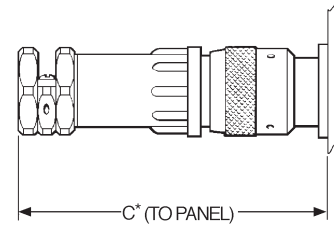
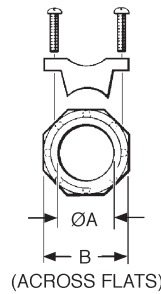

* For disassembly, add 9,00 (.354) for shell sizes 14 and 16 and add 10,60 (.417) for shell size 24.

Sealed Cable Clamps For Use With Neptune Circular Connectors

- For use with jacketed cables.
- Provides Strain relief and wire protection.
- Provides sealing to IP67.
- For assembly instructions, see page 57.

Shell Size	Part Number	Nomenclature	ØA max.	B	C max.	Wire Sealing Diameter	
						Minimum	Maximum
14	192900-0496	TNA 14 CCHC-00L	14,60 (.574)	22,80 (.897)	85,50 (3.366)	6,50 (.256)	12,40 (.488)
16	192900-0497	TNA 16 CCHC-00L	16,60 (.653)	24,70 (.972)	89,80 (3.535)	6,50 (.256)	12,40 (.488)
24	192900-0498	TNA 24 CCHC-00L	29,60 (1.165)	41,80 (1.645)	128,50 (5.059)	17,00 (.670)	26,50 (1.040)

* Assumes a uniformly cylindrical cable. Variations in the diameter could effect sealing.

Neptune Circular

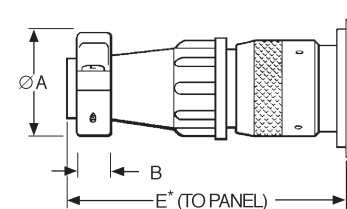
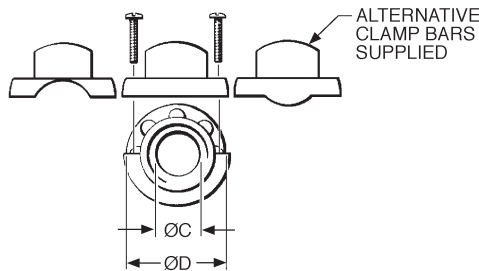

* For disassembly, add 9,00 (.354) for shell sizes 14 and 16 and add 10,60 (.417) for shell size 24.

Unsealed Cable Clamps For Use With Neptune Circular Connectors

- Provides strain relief and wire protection.
- For use with discrete wires or jacketed cables.
- For assembly instructions, see page 59.

Shell Size	Part Number	Nomenclature	ØA max.	B	ØC max.	ØD	E
							max.
14	192900-0286	TNA 14 CCSR-00L	27,00 (1.063)	6,40 (.251)	13,80 (.543)	27,00 (1.063)	67,10 (2.641)
16	192900-0343	TNA 16 CCSR-00L	30,10 (1.185)	6,40 (.251)	17,00 (.669)	30,20 (1.189)	67,10 (2.641)
24	192900-0344	TNA 24 CCSR-00L	41,80 (1.645)	8,20 (.322)	28,00 (1.102)	42,50 (1.673)	90,80 (3.574)



Dimensions shown in mm (inch)
Specifications and dimensions subject to change

www.ittcannon.com

Cannon Trident Connector System

Neptune Circular Connectors



Adapters

Type 1

Adapters facilitate the fitting of various accessories to the Neptune housings.

- External threads for use with conduit.

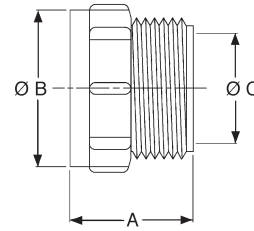

Shell Size	Part Number	Nomenclature	A	ØB	ØC
24	192900-0184	TNA 24 CA01-20L	52,80 (2.078)	40,50 (1.594)	31,80 (1.252)
24	192900-0185	TNA 24 CA01-25L	39,00 (1.535)	40,50 (1.594)	41,00 (1.614)
16	192900-0187	TNA 16 CA01-20L	35,00 (1.378)	28,00 (1.102)	31,80 (1.252)



Type 2

Adapters facilitate the fitting of various accessories to the Neptune housings.

- External grooves for heat shrink tubing or conduit "push-fit" onto the adapter.
- Standard type is recommended for sealed connections to the adapter.
- Drain hole type is recommended for non sealed connections. E.g. split conduit.

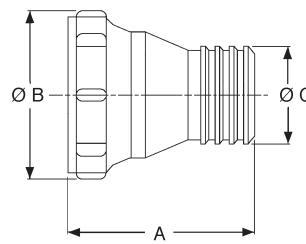

Standard Type

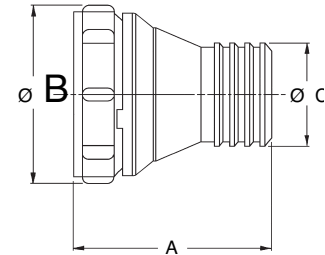

Drain Hole Type

Shell Size	Figure	Part Number	Nomenclature	A	ØB	ØC
24	1	192991-0013	TNA 24 CA02-26L	48,20 (1.897)	43,40 (1.708)	24,00 (.945)
24	2	192900-0654	TNA 24 CA22-26L	48,20 (1.897)	43,40 (1.708)	24,00 (.945)
16	1	192991-0015	TNA 16 CA02-18L	37,80 (1.488)	27,50 (1.082)	17,40 (.685)
16	2	192900-0674	TNA 16 CA22-18L	37,80 (1.488)	29,0 (1.14)	17,40 (.685)



Type 3

Adapters facilitate the fitting of various accessories to the Neptune housings.

- For use with a 90° elbow.
- External threads for use with conduit.

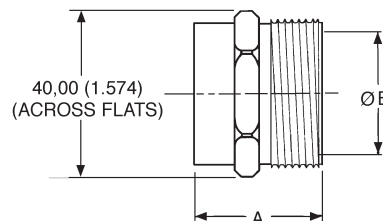

Shell Size	Part Number	Nomenclature	A	ØB
24	192900-0226	TNA 24 CA03-34L	36,50 (1.437)	34,70 (1.366)

Dimensions shown in mm (inch)
Specifications and dimensions subject to change

www.ittcannon.com





Blanking Plugs

- Blanking plugs are used to repair damaged seals. If the membrane seal is pierced in a position that is not normally used, then the blanking plug will restore the seal.

Note: Replacement membrane seals are also available. Contact ITT for details.

Blanking Plugs for Signal Cavities

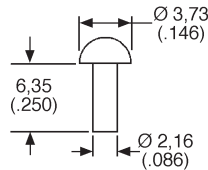

**Part Number
(Pack of 1000)**
192991-0018

Blanking Plugs for Power Cavities

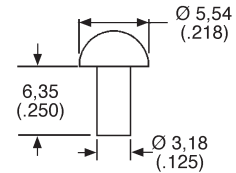

**Part Number
(Pack of 1000)**
192991-0019



Discriminating (Keying) Pins

- Discriminating (keying) pins are used to prevent cross-mating of similar connectors. These pins are used in place of a pin contact. The corresponding socket cavity must be left open. If a socket contact is present the discriminating pin will prevent mating.
- The discriminating pin is installed from the mating side of the connector.

Discriminating Pin Insertion

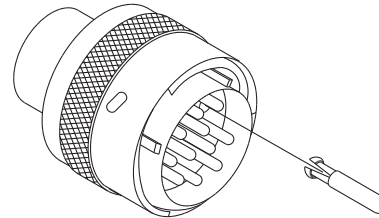

Prevents Cross - Mating

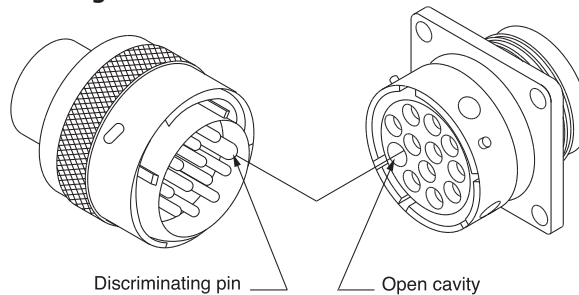

Pin Type	Part Number (Pack of 25)
Signal	192990-0000
Power	192900-0189



Spare Jam Nuts

- Jam nut receptacles are packaged with the jam nut included.

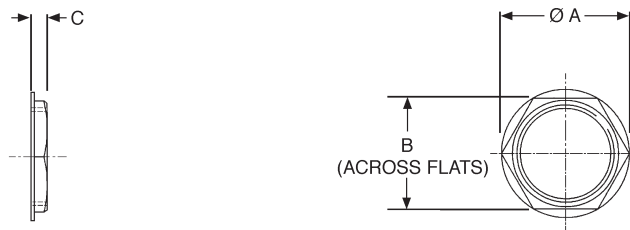

Shell Size	Part Number (Pack of 100)	ØA max.	B Nom	C
14	192900-0489	36,00 (1.417)	31,00 (1.220)	6,00 (.236)
16	192900-0488	40,60 (1.598)	35,00 (1.378)	6,00 (.236)
24	192900-0487	56,80 (2.236)	49,00 (1.929)	7,00 (.275)



Dimensions shown in mm (inch)
Specifications and dimensions subject to change

www.ittcannon.com



Plug Dust Cap

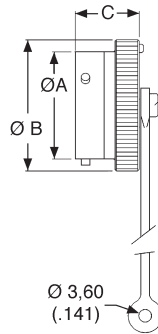

Receptacle Dust Cap

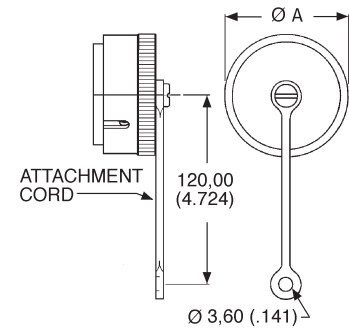

Dust Caps

Plastic Dust Caps are available for both plugs and receptacles. It is immaterial whether these are standard or reversed types, only the shell size matters in determining the correct item.

Shell Size	Part Number (Pack of 100)	ØA	ØB	C
16	192900-0388	25,40 (1.000)	31,70 (1.248)	14,30 (.562)
24	192900-0392	38,10 (1.500)	44,40 (1.748)	16,70 (.657)

Shell Size	Part Number (Pack of 100)	ØA
14	192900-0678	28,60 (1.126)
16	192900-0679	31,70 (1.248)
24	192900-0683	44,40 (1.748)

Flange Type

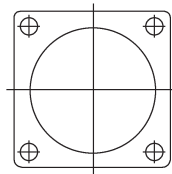

Jam Nut type

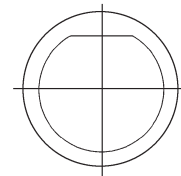

Panel Gaskets

- All panel gaskets are 1,50 (.059) thick.
- Bulk packaged. Sold in packs of 100.

Shell Size	Part Number (Pack of 100)
14	192900-0565
16	192900-0566
24	192900-0687

Shell Size	Part Number (Pack of 100)
14	192900-0457
16	192900-0402
24	192900-0458

TNM (Trident/Neptune Metal) is specifically designed to meet the needs of systems that require shielding, sealing, and the extra durability of a metal shell. The combination of Trident contacts, membrane seals, and the Universal Shielded Endbell* make TNM both cost effective and easy to assemble.

Applications

- Communication equipment.
- Industrial electronics.
- Heavy duty equipment.



*Patent pending

Product Features

- Accepts Trident signal, printed circuit, and coaxial contacts.
- Mixed signal and 30 A power contact version.
- Can be sealed to IP67.
- 360° shielding.
- Easy to assemble.

Performance Specifications

Temperature Range	-55°C to 105°C (-67°F to 221°F)
Operating Voltage	250 V ac
Test Voltage	2000 V ac rms
Insulation Resistance	5000 MΩ min. at 500 V dc
Current Rating (Single Contact)	13 A or 6 A signal contacts (crimp), 30 A power contacts
Sealing (Sealed Version)	Up to IP67

Materials and Finishes

Description	Material	Finish
Shell	High Specification Zinc Alloy	Nickel
Insulator	Nylon, UL 94V-0	None
Coupling Ring	Brass	Nickel
Seal	Rubber	None

TNM Connectors

TNM features nickel plated zinc alloy shells and UL 94V-0 rated thermoplastic insulators. All TNM receptacles are supplied with an interface seal to provide sealing between connectors to IP67. In addition a membrane seal is available for those applications requiring the sealing of discrete wires at the rear of the connector.

In order to seal multicore jacketed cables to connectors an endbell is available. This has 'O' ring sealing to the connector and a second seal to the cable jacket.

- Available unsealed or sealed to IP67.
- Highly reliable Bayonet Coupling System.
- See pages 40-41 for part numbers and additional information.



Universal Endbell

The Universal Endbell provides sealing, shielding and strain relief in an easy to assemble system.

- 360° shielding.
- Sealed to IP67.
- Provides strain relief.
- Easy to assemble.
- See page 44 for part numbers and additional information.



TNM
Circular

Contact Cavity Arrangements

Mating Face View

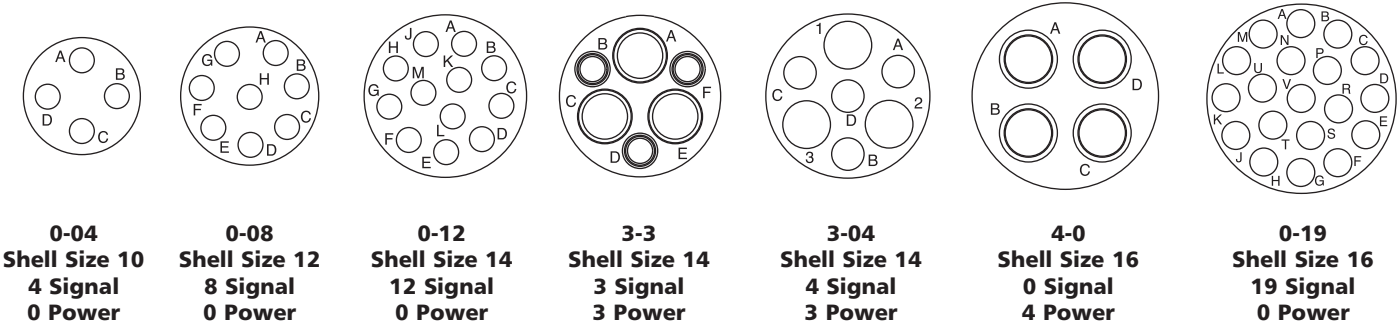

Wire sealing range 1,70 to 2,70 (.066 to .106)

Dimensions shown in mm (inch)
Specifications and dimensions subject to change

www.ittcannon.com



Cannon Trident Connector System

TNM Circular Connectors

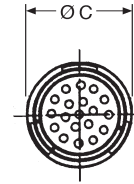
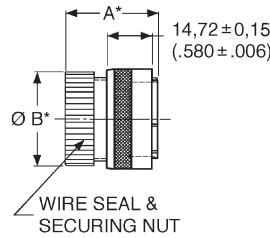

Standard Plugs — Pin Contacts

Standard Plug

Part Numbers — with wire seal

Number of Contacts	Shell Size	Part Number	Nomenclature	A	ØB	ØC
4	10	192993-0011	TNM 6S 1000-04 P1L	42,50 (1.673)	17,50 (.689)	21,60 (.850)
8	12	192993-0012	TNM 6S 1200-08 P1L	42,50 (1.673)	20,60 (.811)	24,80 (.976)
3-4	14	192993-0695	TNM 6S 1403-04 P1L	42,50 (1.673)	24,30 (.957)	28,00 (1.102)
12	14	192993-0013	TNM 6S 1400-12 P1L	42,50 (1.673)	24,30 (.957)	28,00 (1.102)
19	16	192993-0014	TNM 6S 1600-19 P1L	42,50 (1.673)	27,00 (1.063)	31,20 (1.229)

Part Numbers — without wire seal and securing nut ♦

Number of Contacts	Shell Size	Part Number	Nomenclature	A*	ØB*	ØC
4	10	192993-0001	TNM 6U 1000-04 P1L	38,10 (1.500)	13,80 (.543)	21,60 (.850)
8	12	192993-0002	TNM 6U 1200-08 P1L	38,10 (1.500)	16,90 (.665)	24,80 (.976)
12	14	192993-0003	TNM 6U 1400-12 P1L	38,10 (1.500)	20,10 (.791)	28,00 (1.102)
19	16	192993-0004	TNM 6U 1600-19 P1L	38,10 (1.500)	23,30 (.917)	31,20 (1.229)

* Dimensions A and B apply to connectors without wire seals and securing nuts.

♦ Can be sealed to IP67 with a sealed endbell, see page 42.

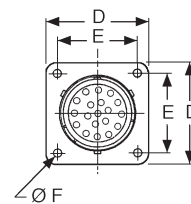
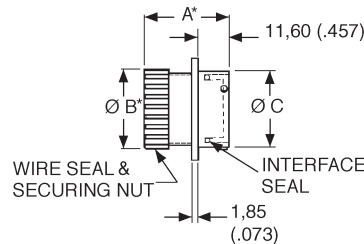

Panel Cutout

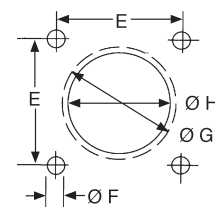

ØH = Flange in Front of Panel
ØG = Flange at Rear of Panel

Standard Receptacles — Socket Contacts

Standard Receptacle

Part Numbers — with wire seal

No. of Contacts	Shell Size	Part Number	Nomenclature	A	ØB	ØC	D	E	ØF	ØG	ØH
4	10	192993-0031	TNM OS 1000-04 S1L	34,70 (1.366)	17,50 (.689)	14,92 (.563)	23,79 (.937)	18,26 (.719)	3,20 (.126)	17,30 (.681)	15,10 (.594)
8	12	192993-0032	TNM OS 1200-08 S1L	34,70 (1.366)	20,60 (.811)	18,98 (.747)	26,15 (1.030)	20,62 (.812)	3,20 (.126)	21,80 (.858)	18,20 (.717)
3-4	14	192993-0698	TNM OS 1403-04 S1L	34,70 (1.366)	24,30 (.957)	22,16 (.872)	28,54 (1.124)	22,80 (.898)	3,50 (.138)	25,00 (.984)	21,40 (.843)
12	14	192993-0033	TNM OS 1400-12 S1L	34,70 (1.366)	24,30 (.957)	22,16 (.872)	28,54 (1.124)	22,80 (.898)	3,50 (.138)	25,00 (.984)	21,40 (.843)
19	16	192993-0034	TNM OS 1600-19 S1L	34,70 (1.366)	27,00 (1.063)	25,33 (.997)	30,89 (1.216)	24,61 (.969)	3,50 (.138)	28,10 (1.106)	24,60 (.969)

Part Numbers — without wire seal and securing nut ♦

No. of Contacts	Shell Size	Part Number	Nomenclature	A*	ØB*	ØC	D	E	ØF	ØG	ØH
4	10	192993-0021	TNM OU 1000-04 S1L	30,30 (1.193)	14,30 (.563)	14,92 (.563)	23,79 (.937)	18,26 (.719)	3,20 (.126)	17,30 (.681)	15,10 (.594)
8	12	192993-0022	TNM OU 1200-08 S1L	30,30 (1.193)	17,40 (.685)	18,98 (.747)	26,15 (1.030)	20,62 (.812)	3,20 (.126)	21,80 (.858)	18,20 (.717)
12	14	192993-0023	TNM OU 1400-12 S1L	30,30 (1.193)	20,60 (.811)	22,16 (.872)	28,54 (1.124)	22,80 (.898)	3,50 (.138)	25,00 (.984)	21,40 (.843)
19	16	192993-0024	TNM OU 1600-19 S1L	30,30 (1.193)	23,80 (.937)	25,33 (.997)	30,89 (1.216)	24,61 (.969)	3,50 (.138)	28,10 (1.106)	24,60 (.969)

* Dimensions A and B apply to connectors without wire seals and securing nuts.

♦ Can be sealed to IP67 with a sealed endbell, see page 42.



Dimensions shown in mm (inch)
Specifications and dimensions subject to change

www.ittcannon.com

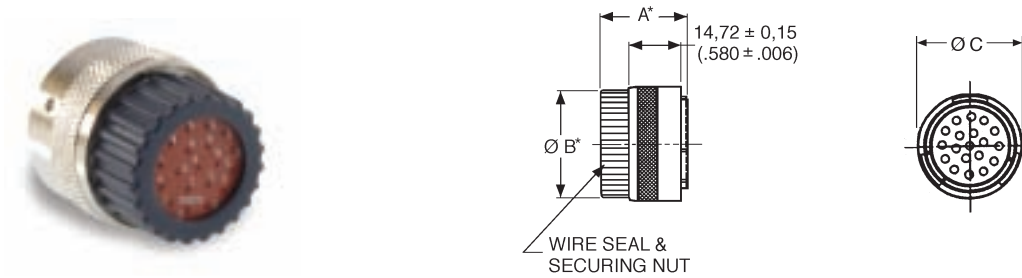

Reversed Plugs — Socket Contacts

Reversed Plug

Part Numbers — with wire seal

Number of Contacts	Shell Size	Part Number	Nomenclature	A	ØB	ØC
4	10	192993-0051	TNM 6S 1000-04 S1L	34,20 (1.346)	17,50 (.689)	21,60 (.850)
8	12	192993-0052	TNM 6S 1200-08 S1L	34,20 (1.346)	20,60 (.811)	24,80 (.976)
3-4	14	192993-0696	TNM 6S 1403-04 S1L	34,20 (1.346)	24,30 (.957)	28,00 (1.102)
12	14	192993-0053	TNM 6S 1400-12 S1L	34,20 (1.346)	24,30 (.957)	28,00 (1.102)
19	16	192993-0054	TNM 6S 1600-19 S1L	34,20 (1.346)	27,00 (1.063)	31,20 (1.229)

Part Numbers — without wire seal and securing nut

Number of Contacts	Shell Size	Part Number	Nomenclature	A*	ØB*	ØC
4	10	192993-0041	TNM 6U 1000-04 S1L	29,80 (1.173)	13,80 (.543)	21,60 (.850)
8	12	192993-0042	TNM 6U 1200-08 S1L	29,80 (1.173)	16,90 (.665)	24,80 (.976)
12	14	192993-0043	TNM 6U 1400-12 S1L	29,80 (1.173)	20,10 (.791)	28,00 (1.102)
19	16	192993-0044	TNM 6U 1600-19 S1L	29,80 (1.173)	23,30 (.917)	31,20 (1.229)

* Dimensions A and B apply to connectors without wire seals and securing nuts.

◆ Can be sealed to IP67 with a sealed endbell, see page 42.

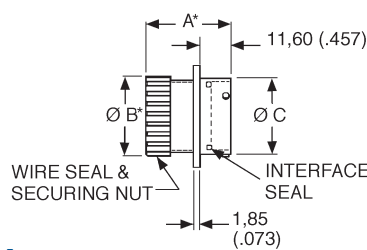

Panel Cutout

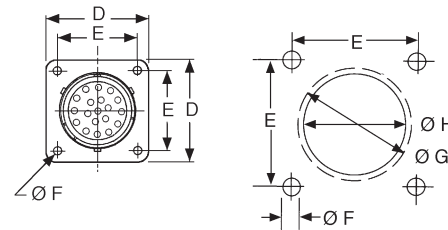

ØH = Flange in Front of Panel
ØG = Flange at Rear of Panel

Reversed Receptacles— Pin Contacts

Reversed Receptacle

Part Numbers — with wire seal

No. of Contacts	Shell Size	Part Number	Nomenclature	A	ØB	ØC	D	E	ØF	ØG	ØH
4	10	192993-0071	TNM 0S 1000-04 P1L	43,00 (1.693)	17,50 (.689)	14,92 (.563)	23,79 (.937)	18,26 (.719)	3,20 (.126)	17,30 (.681)	15,10 (.594)
8	12	192993-0072	TNM 0S 1200-08 P1L	43,00 (1.693)	20,60 (.811)	18,98 (.747)	26,15 (1.030)	20,62 (.812)	3,20 (.126)	21,80 (.858)	18,20 (.717)
7	14	192993-0697	TNM 0S 1403-04 P1L	43,00 (1.693)	24,30 (.957)	22,16 (.872)	28,54 (1.124)	22,80 (.898)	3,50 (.138)	25,00 (.984)	21,40 (.843)
12	14	192993-0073	TNM 0S 1400-12 P1L	43,00 (1.693)	24,30 (.957)	22,16 (.872)	28,54 (1.124)	22,80 (.898)	3,50 (.138)	25,00 (.984)	21,40 (.843)
19	16	192993-0074	TNM 0S 1600-19 P1L	43,00 (1.693)	27,00 (1.063)	25,33 (.997)	30,89 (1.216)	24,61 (.969)	3,50 (.138)	28,10 (1.106)	24,60 (.969)

Part Numbers — without wire seal and securing nut

No. of Contacts	Shell Size	Part Number	Nomenclature	A*	ØB*	ØC	D	E	ØF	ØG	ØH
4	10	192993-0061	TNM 0U 1000-04 P1L	38,60 (1.520)	14,30 (.563)	14,92 (.563)	23,79 (.937)	18,26 (.719)	3,20 (.126)	17,30 (.681)	15,10 (.594)
8	12	192993-0062	TNM 0U 1200-08 P1L	38,60 (1.520)	17,40 (.685)	18,98 (.747)	26,15 (1.030)	20,62 (.812)	3,20 (.126)	21,80 (.858)	18,20 (.717)
12	14	192993-0063	TNM 0U 1400-12 P1L	38,60 (1.520)	20,60 (.811)	22,16 (.872)	28,54 (1.124)	22,80 (.898)	3,50 (.138)	25,00 (.984)	21,40 (.843)
19	16	192993-0064	TNM 0U 1600-19 P1L	38,60 (1.520)	23,80 (.937)	25,33 (.997)	30,89 (1.216)	24,61 (.969)	3,50 (.138)	28,10 (1.106)	24,60 (.969)

* Dimensions A and B apply to connectors without wire seals and securing nuts.

◆ Can be sealed to IP67 with a sealed endbell, see page 42.

Dimensions shown in mm (inch)

Specifications and dimensions subject to change

www.ittcannon.com



TNM Circular

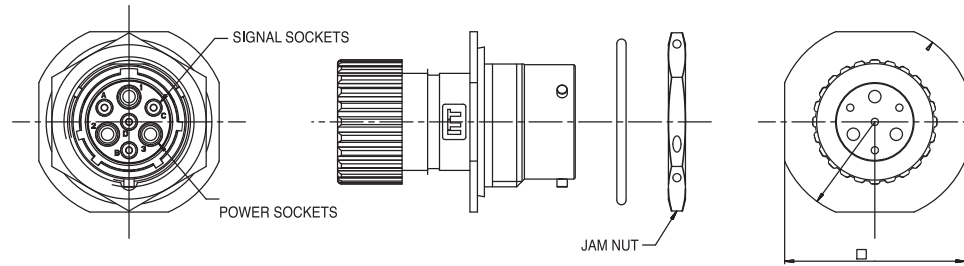

Panel Cutout

Jam Nut Receptacles

- Mates with Standard and Reversed Plugs, see pages 40-41

Type	Number of Contacts	Shell Size	Part Number	Nomenclature	A	B	C	ØD	ØE	ØF	ØG
Standard	3-04	14	192993-0700	TNM 75 1403045S1L	50,00 (1.968)	2,80 (.110)	17,60 (.692)	22,20 (.874)	24,30 (.956)	38,09 (1,500)	34,90(1.374)
Reversed	3-04	14	192993-0699	TNM 75 1403045P1L	50,00 (1.968)	2,80 (.110)	17,60 (.692)	22,20 (.874)	24,30 (.956)	38,09 (1,500)	34,90(1.374)

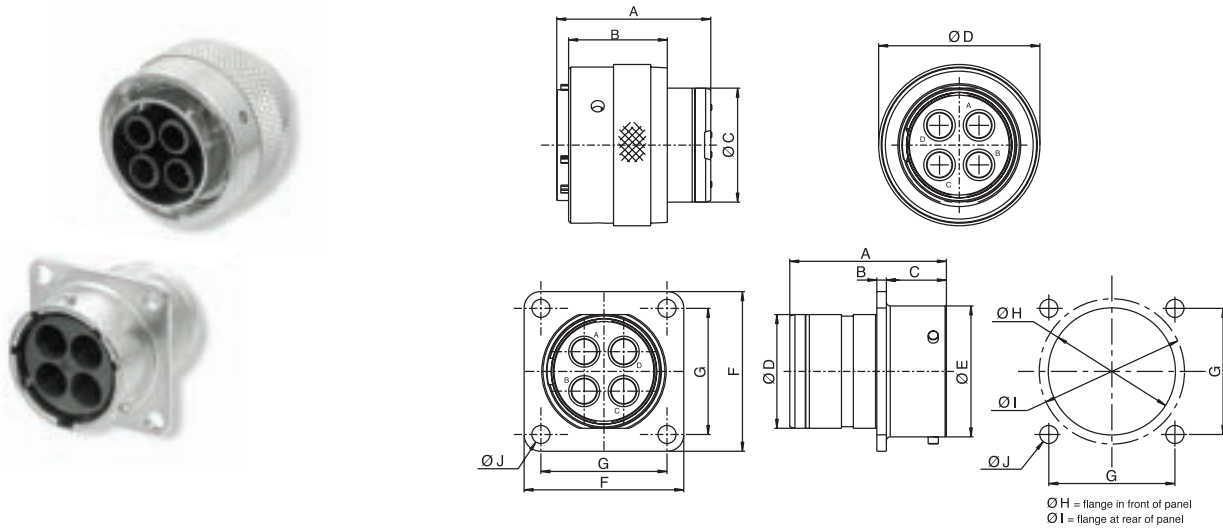

Four Way Power Connector

This connector was developed for use on servomotors where high currents and high voltages are used

- Uses Cannon D Subminiature power contacts.
- Current rating 40A.
- Voltage rating 40A.
- Earth contact version available.
- Short receptacle to save space.

Type	No. of Contacts	Shell Size	Part Number	Nomenclature	A	B	C	D	E	F	G	H	I	J
Reversed Receptacle	4	16	192993-0106	TNM192993-106	30.3	1.85	11.6	23.7	25.33	30.9	24.4	24.6	28.1	3.5
Reversed Plug	4	16	192993-0105	TNM192993-105	29.8	19.1	23.2	31.2						



Dimensions shown in mm (inch)
Specifications and dimensions subject to change

www.ittcannon.com

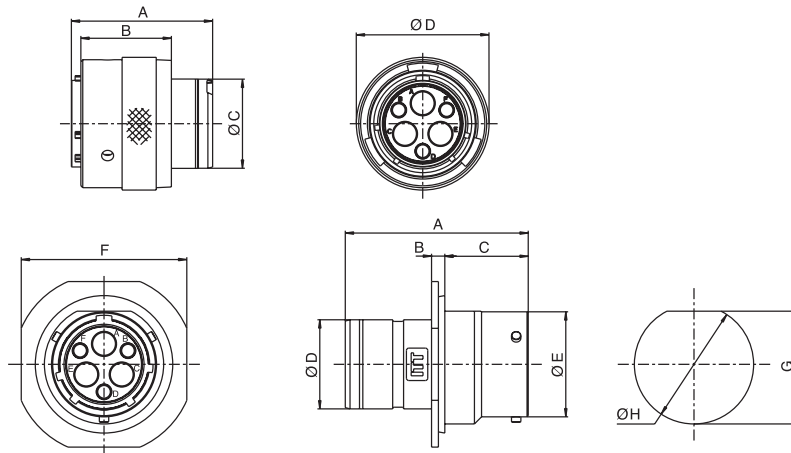

3-3 Connector

Designed for use as an antenna connector, this design incorporates D Subminiature power contacts and standard Trident signal contacts.

- Can terminate wire sizes up to 8 AWG (10mm²)
- Large cables with outside diameters up to 16,00 (.630) diameter can be accommodated.

For more information, please contact your local Cannon sales office.

Type	Number of Contacts	Shell Size	Part Number	A	B	C	D	E	F	G	H
Standard Receptacle Pin	6	14	192993-2013	38.6	2.8	17.6	18.8	22.16	34.9	24.2	25.8
Standard Plug Socket	6	14	192993-0261	29.8	19.1	18.85	28				

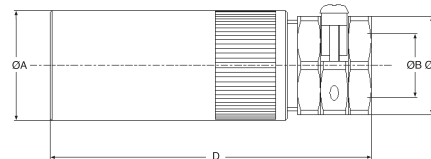

Shielded Endbell for Larger Cable Sizes

- Metal body with plastic cable clamp.
- For assembly instructions, see page 61.
- For use with jacketed cables.

Shell Size	Part Number	Nomenclature	Cable Accommodation		ØAmax.	ØB min.	ØB max.	ØC	ØD max.
			Outer Sheath Diameter						
			Minimum	Maximum					
10	192993-0091	TNA 10CC-SE01L	5,00 (.196)	10,00 (.393)	18,10 (.712)	5,00 (.196)	10,00 (.393)	19,00 (.748)	70,00 (2.755)
12	192993-0092	TNA 12CC-SE01L	6,00 (.236)	12,00 (.472)	21,20 (.834)	6,00 (.236)	12,00 (.472)	21,00 (.826)	72,00 (2.834)
14	192993-0093	TNA 14CC-SE01L	7,00 (.275)	14,00 (.551)	24,20 (.952)	7,00 (.275)	14,00 (.551)	23,00 (.905)	78,00 (3.070)
16	192993-0094	TNA 16CC-SE01L	8,00 (.314)	16,00 (.692)	27,60 (1.086)	8,00 (.314)	16,00 (.629)	25,00 (.984)	82,50 (3.248)

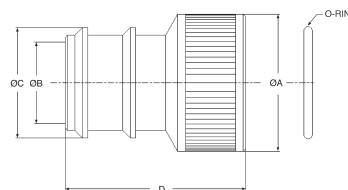

Heat Shrink Adapter for use with TNM Circular Connectors

Shell Size	Part Number	Nomenclature	Ø Amax.	ØB min.	ØC	ØDmax
10	192993-0631	TNA 10HSAD 00L	18,10 (.712)	10,20 (.401)	16,00 (.629)	35,50 (1.397)
12	192993-0632	TNA 12HSAD 00L	21,20 (.834)	12,20 (.480)	18,00 (.708)	36,00 (1.417)
14	192993-0633	TNA 14HSAD 00L	24,20 (.952)	14,20 (.559)	20,00 (.787)	36,00 (1.417)
16	192993-0634	TNA 16HSAD 00L	27,60 (1.086)	16,30 (.641)	22,00 (.866)	36,50 (1.437)

Dimensions shown in mm (inch)
Specifications and dimensions subject to change

www.ittcannon.com





Universal Shielded Endbell*

In order to meet EMC requirements it will be necessary to fit a shielded endbell to the TNM connectors. The TNM Shielded Endbell provides sealing to the connector shell, a cable braid grip and sealing to the outer sheath of the cable. Sealing rating is IP67.

Shielded endbells are used with unsealed plugs and receptacles.

Materials and Finishes

Description	Material/Finish
Housing	Aluminum/Nickel
Grounding Ring	Aluminum/Nickel
Clamp Nut	Aluminum/Nickel
Cable Grip	Nylon, UL 94V-0
Support Sleeve	Nylon, UL 94V-0
O-Ring	Rubber
Cable Seal	Rubber

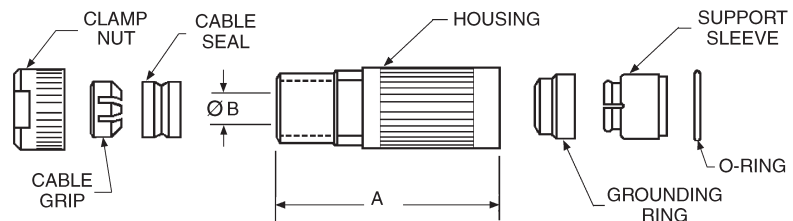
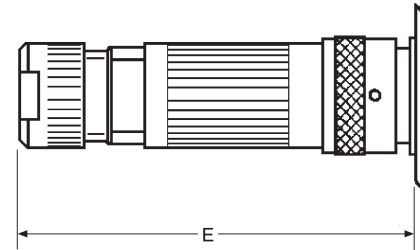
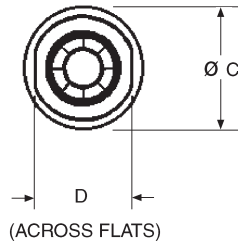

For assembly instruction, see page 58.

Dimensions

Shell Size	Part Number	Nomenclature	A	ØB	ØC	D	E max.	
							Standard Format	Reversed Format
10	192993-0081	TNA 10 CCSE00L	56,60 (2.228)	8,00 (.315)	17,90 (.705)	13,00 (.512)	88,50 (3.484)	80,00 (3.150)
12	192993-0082	TNA 12 CCSE00L	56,70 (2.320)	10,00 (.394)	21,00 (.827)	16,00 (.630)	88,50 (3.484)	80,00 (3.150)
14	192993-0083	TNA 14 CCSE00L	57,00 (2.441)	11,30 (.449)	24,00 (.945)	19,00 (.748)	88,50 (3.484)	80,00 (3.150)
16	192993-0084	TNA 16 CCSE00L	57,40 (2.260)	13,60 (.535)	27,40 (1.079)	22,00 (.886)	88,50 (3.484)	80,00 (3.150)

*Patent Pending

Cables

The TNM Shielded Endbell covers a wide range of multicore cable used in industrial applications. The following table indicates the sizes that can be accommodated provided the outside sheath diameter is within the accommodation range shown.

For detail of contacts, see page 47.

Shielded cable to Endbell Assembly Instructions are supplied with the Endbell piece parts kit.

Endbell Shell Size	Number of Contacts	Cable Accommodation Outer Sheath Size	
		Minimum	Maximum
10	4	4,40 (.173)	7,30 (.287)
12	8	6,40 (.252)	9,50 (.374)
14	12	6,90 (.272)	10,20 (.402)
16	19	7,90 (.311)	12,60 (.496)



Dimensions shown in mm (inch)
Specifications and dimensions subject to change

www.ittcannon.com



Sealed Cable Clamps for use with TNM Circular Connectors

- For use with jacketed cables.
- Provides strain relief and wire protection.
- Provides sealing to IP67.
- For assembly instructions, see page 59.

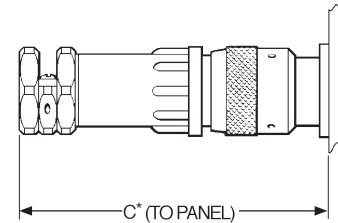
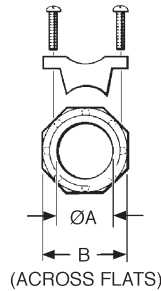

* For disassembly, add 9,000 (.0354) for shell sizes 10-16.

Dimensions

Shell Size	Part Number	Nomenclature	ØA max.	B	C max.	
					Standard Format	Reversed Format
10	192900-0636	TNA 10 CCHC00L	11,10 (.437)	8,70 (.740)	89,00 (3.504)	80,70 (3.177)
12	192900-0637	TNA 12 CCHC00L	13,60 (.535)	20,80 (.818)	92,00 (3.622)	83,70 (3.295)
14	192900-0496	TNA 14 CCHC00L	14,60 (.574)	22,80 (.897)	99,00 (3.898)	90,70 (3.571)
16	192900-0497	TNA 16 CCHC00L	16,60 (.653)	24,70 (.972)	103,00 (4.055)	94,70 (3.728)

* Assumes a uniformly cylindrical cable. Variations in the diameter could effect sealing.

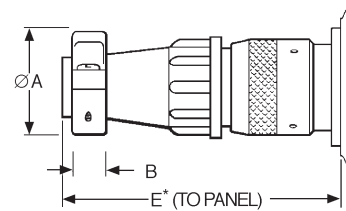
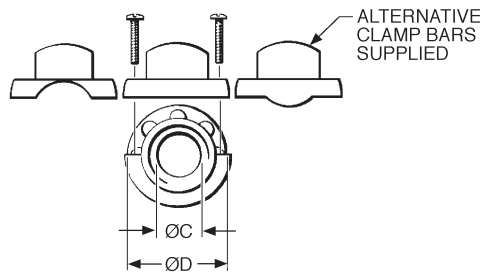

* For disassembly, add 9,000 (.0354) for shell sizes 10-16.

Unsealed Cable Clamps for use with TNM Circular Connectors

- Provides strain relief and wire protection.
- For use with discrete wires or jacketed cables.
- For assembly instructions, see page 59.

Dimensions

Shell Size	Part Number	Nomenclature	ØA max.	B	ØC max.	ØD	E max.	
							Standard Format	Reversed Format
10	192900-0639	TNA 10 CCSR00L	21,50 (.846)	6,40 (.251)	8,70 (.342)	21,00 (.826)	74,50 (2.933)	66,20 (2.606)
12	192900-0640	TNA 12 CCSR00L	24,90 (.980)	6,40 (.251)	12,80 (.503)	24,00 (.944)	74,50 (2.933)	66,20 (2.606)
14	192900-0286	TNA 14 CCSR00L	27,00 (1.063)	6,40 (.251)	13,80 (.543)	27,00 (1.063)	80,50 (3.169)	71,80 (2.826)
16	192900-0343	TNA 16 CCSR00L	30,10 (1.185)	6,40 (.251)	17,00 (.669)	30,20 (1.189)	80,50 (3.169)	71,80 (2.826)

Dimensions shown in mm (inch)
Specifications and dimensions subject to change

www.ittcannon.com



General recommendations for the selection of Trident contacts are listed below.

Platings: Tin is recommended for most applications. It is cost effective and matches well to most wires. Gold is preferred for special situations. Gold resists oxidation, has high surface conductivity, and has a low coefficient of friction. These features make gold the preferred plating for low level signals (a rule of thumb is <100 mA), corrosive environments (for unsealed connectors), and for increased mating cycles. The electrical performance of the contact is determined at the surface of the contact. For this reason, flash gold platings are suitable for applications with 50 or fewer mating cycles. Thicker gold platings are recommended for more than 50 mating cycles.

Stamped versus Machined: The two part stamped contacts are manufactured to precise tolerances and are field proven. They can be supplied on reels which lowers assembly costs for volume



production. Machined contacts offer improved precision and durability. They are recommended for applications with more than 200 mating cycles.

Crimp versus Solder: Crimp contacts offer improved electrical performance, strain relief and quality control compared to solder cup contacts. Solder cups contacts are recommended for low

volume and prototype applications where the added cost of crimp tools is not justified.

High Conductivity: These contacts use a different base material than the standard contacts. They are recommended for high current applications. These contacts will also reduce the derating of connectors with several high current lines.

Contact Performance Data

Characteristics	Formed (Stamped)		Machined	Solder Cup	Flow Solder (PCB)	30 A Power	Coaxial
	Standard	High Conductivity					
Body Material	Brass	Copper Alloy	Brass	Brass	Brass	Copper Alloy	Brass
Retention	Brass	Brass	Beryllium	Beryllium	Beryllium	Stainless Steel	Beryllium
Spring Material			Copper	Copper	Copper		Copper
Contact Retention (minimum)	67 N	67 N	67 N	67 N	67 N	100 N	67 N
Current Rating	13 A	16 A	13 A	13 A	13 A	30 A	N/A
Contact Resistance (initial)	5 mΩ	5 mΩ	5 mΩ	5 mΩ	5 mΩ	2.5 mΩ	2.5 m
Mechanical Endurance (minimum)	200 Insertions	200 Insertions	500 Insertions	500 Insertions	500 Insertions	200 Insertions	200 Insertions

For Tooling and Assembly instructions, see pages 51-58.

Temperature/Current Rating

30°C Temperature Rise

- Derived in accordance with IEC 512-3, Test 5b.
- Figures are for maximum wire sizes. Smaller wires will reduce rating.
- All contacts equally loaded.
- PCB mounted connectors will be limited by PCB performance.
- Bunched cables will further reduce values.
- Cable insulation type will affect temperature and loading.
- Figures are for maximum connector sizes in each range. Smaller connectors will increase rating.

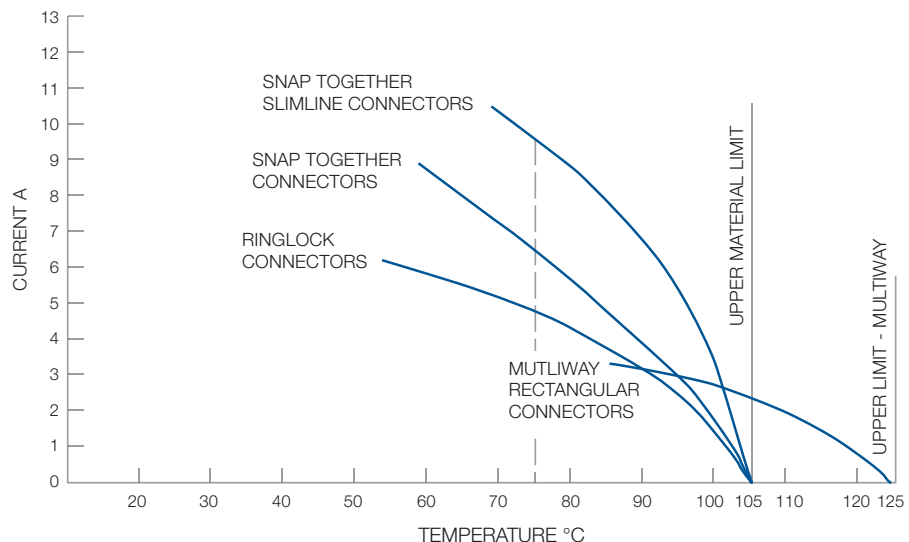

Dimensions shown in mm (inch)
Specifications and dimensions subject to change

www.ittcannon.com



Contact Selection Guide

Formed (Stamped) Crimp Contacts



- Tin and gold plating available.
- Up to 200 mating cycles.
- Up to 13 A - Standard Contacts.
16 A - High Conductivity Contacts.
- Supports 14 AWG to 26 AWG wires.
- Brass and high conductivity material available.
- Full support tooling available.

For Part Numbers and Details, see page 46.

Machined Crimp Contacts



- Tin and gold plating available.
- Up to 500 mating cycles.
- Up to 13 A.
- Supports 16 AWG to 26 AWG wires.
- Full support tooling available.
- Earthing (First Mate/Last Break) versions available.

For Part Numbers and Details, see page 47.

Solder Cup Contacts

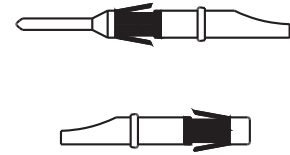

- Tin plating.
- Supports 14 AWG to 26 AWG wires.
- Ideal for prototypes and low volume production.
- Up to 13 A.

For Part Numbers and Details, see page 48.

Flow Solder (PCB) Contacts



- Tin and gold plating available.
- Signal and Power versions available (13 A or 30 A).
- For use with the Multiway, Ringlock, and Neptune ranges.

For Part Numbers and Details, see page 48.

30 A Power Contacts



- Tin plating.
- For use with the Neptune Circular Connectors.
- Full support tooling available.
- High conductivity material.

For Part Numbers and Details, see page 48.

Coaxial Contacts

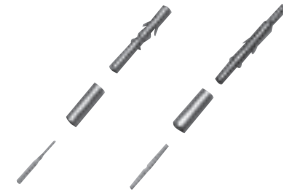

- Fits into standard Trident contact cavities.
- Up to 200 mating cycles.
- Full support tooling available.
- Supports a wide range of twisted pair and coaxial cables.

For Part Numbers and Details, see pages 49-50.

Connector/Contact Compatibility

Connector Series	Contacts					
	Formed (Stamped) Crimp	Machined Crimp	Solder Cup	Flow Solder (PCB)	30 A Power	Coaxial
Snap Together & Slimline	•	•	•	•*	—	•
Multiway	•	•	•	•	—	•
Ringlock	•	•	•	•	—	•
Neptune	•	•	•	•	•	•
TNM	•	•	•	—	—	•

• = Compatible
 * = Printed circuit contacts are pre-installed in Snap Together & Slimline connectors.
 For wire wrap contacts, contact Cannon.
 For discriminating (keying) pins, see page 50.

Dimensions shown in mm (inch)
 Specifications and dimensions subject to change

www.ittcannon.com



Formed (Stamped) Crimp Contacts — Standard Brass Material

- 13 A current rating.
- Three plating styles available.
- Separate retention spring.
- Up to 200 mating cycles.
- Wide range of wire sizes.
- Full support tooling available, see page 53.
- Two part design.



**Size 14 to 16 AWG,
No Insulation Grip**

**Size 16 to 26 AWG,
Insulation Grip**

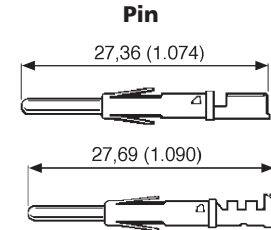
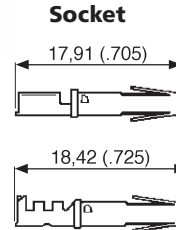

Contact	Part Number Pack (100)			Part Number Reeled (3000)			Wire Range mm2	Wire Size	Insulation Diameter	Strip Length
	Tin Plating	Gold Flash	Gold Plating	Tin Plating	Gold Flash	Gold Plating				
Pin	192990-0020	192990-0080	192900-0448	192990-2510	192990-2650	192900-0406	0,08 - 0,25	26-24 AWG	0,89 (.035) - 1,58 (.062)	3,95 (.155)±0,25(.009)
Socket	192990-0030	192990-0090	192900-0452	192990-2550	192990-2690	192900-0410	0,08 - 0,25	26-24 AWG	0,89 (.035) - 1,58 (.062)	3,95 (.155)±0,25(.009)
Pin	192990-0040	192922-1460	192900-0447	192990-2500	192990-2640	192900-0405	0,30 - 0,50	22-20 AWG	1,17 (.046) - 2,08 (.081)	3,95 (.155)±0,25(.009)
Socket	192990-0050	192922-1470	192900-0451	192990-2540	192990-2680	192900-0409	0,30 - 0,50	22-20 AWG	1,17 (.046) - 2,08 (.081)	3,95 (.155)±0,25(.009)
Pin	192990-0060	192990-0100	192900-0446	192990-2490	192990-2630	192900-0404	0,75 - 1,50	18-16 AWG	2,00 (.078) - 3,00 (.118)	3,95 (.155)±0,25(.009)
Socket	192990-0070	192990-0110	192900-0450	192990-2530	192990-2670	192900-0408	0,75 - 1,50	18-16 AWG	2,00 (.078) - 3,00 (.118)	3,95 (.155)±0,25(.009)
Pin	192990-1240	192990-1220	192900-0445	192990-2480	192990-2620	192900-0403	1,50 - 2,50	16-14 AWG	Without insulation support	5,60 (.220)±0,25(.009)
Socket	192990-1250	192990-1230	192900-0449	192990-2520	192990-2660	192900-0407	1,50 - 2,50	16-14 AWG	Without insulation support	5,60 (.220)±0,25(.009)

Formed (Stamped) Crimp Contacts — High Conductivity Material

- 16 A current rating.
- Recommended for elevated temperatures.
- High conductivity copper alloy with tin plating.
- For use with standard crimp tooling, see page 53.
- Two part design.



**Size 14 to 16 AWG,
No Insulation Grip**

**Size 16 to 26 AWG,
Insulation Grip**

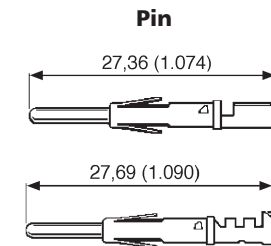
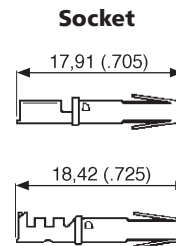

Contact	Part Number		Wire Range mm2	Wire Size	Insulation Diameter	Strip Length
	Pack (100)	Reeled (3000)				
Pin	192900-0122	192900-0120	0,08 - 0,25	26-24 AWG	0,89 (.035) - 1,58 (.062)	3,95 (.155)±0,25 (.009)
Socket	192900-0123	192900-0121	0,08 - 0,25	26-24 AWG	0,89 (.035) - 1,58 (.062)	3,95 (.155)±0,25 (.009)
Pin	192900-0126	192900-0124	0,25 - 0,50	22-20 AWG	1,17 (.046) - 2,08 (.081)	3,95 (.155)±0,25 (.009)
Socket	192900-0127	192900-0125	0,25 - 0,50	22-20 AWG	1,17 (.046) - 2,08 (.081)	3,95 (.155)±0,25 (.009)
Pin	192900-0002	192900-0000	0,75 - 1,50	18-16 AWG	2,00 (.078) - 3,00 (.118)	3,95 (.155)±0,25 (.009)
Socket	192900-0003	192900-0001	0,75 - 1,50	18-16 AWG	2,00 (.078) - 3,00 (.118)	3,95 (.155)±0,25 (.009)
Pin	192900-0005	192900-0004	1,50 - 2,50	16-14 AWG	Without insulation support	5,60 (.220)±0,25 (.009)
Socket	192900-0007	192900-0006	1,50 - 2,50	16-14 AWG	Without insulation support	5,60 (.220)±0,25 (.009)



Machined Crimp Contacts

- 13 A current rating.
- Separate contact and retention spring.
- Up to 500 mating cycles.
- Variety of plating options.
- Full support tooling available, see page 53.



**Size 16 AWG,
No Insulation Grip**

**Size 20 to 26 AWG,
Insulation Grip**

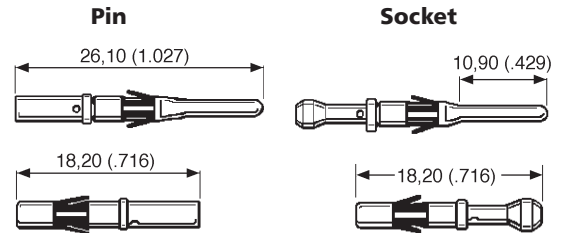

Contact	Part Number			Wire Range mm2	Wire Size	Insulation Diameter	Strip Length	Color Band
	Pack (100) Gold Plating†	Pack (100) Gold Plating*	Pack (100) Tin Plating					
Pin	192991-0101	192991-0100	192991-0102	0,08 - 0,23	26 AWG	0,90 (.035) - 1,40 (.055)	5,08 (.200)±0,25 (.009)	Black
Socket	192991-0054	192991-0042	192991-0048	0,08 - 0,23	26 AWG	0,90 (.035) - 1,40 (.055)	5,08 (.200)±0,25 (.009)	Black
Pin	192991-0093	192991-0092	192991-0094	0,20 - 0,24	24 AWG	1,05 (.041) - 1,60 (.062)	5,08 (.200)±0,25 (.009)	Blue
Socket	192991-0055	192991-0043	192991-0049	0,20 - 0,24	24 AWG	1,05 (.041) - 1,60 (.062)	5,08 (.200)±0,25 (.009)	Blue
Pin	192991-0097	192991-0096	192991-0098	0,25 - 0,50	22 AWG	1,60 (.062) - 2,15 (.084)	5,08 (.200)±0,25 (.009)	Red
Socket	192991-0056	192991-0044	192991-0050	0,25 - 0,50	22 AWG	1,60 (.062) - 2,15 (.084)	5,08 (.200)±0,25 (.009)	Red
Pin	192991-0089	192991-0088	192991-0090	0,44 - 0,64	20 AWG	1,60 (.062) - 2,10 (.082)	5,08 (.200)±0,25 (.009)	Green
Socket	192991-0058	192991-0046	192991-0052	0,44 - 0,64	20 AWG	1,60 (.062) - 2,10 (.082)	5,08 (.200)±0,25 (.009)	Green
Pin	192991-0085	192991-0084	192991-0086	0,60 - 1,51	16 AWG	Without insulation support	7,11 (.279)±0,25 (.009)	Black
Socket	192991-0059	192991-0047	192991-0053	0,60 - 1,51	16 AWG	Without insulation support	7,11 (.279)±0,25 (.009)	Black

* Gold plating Pin: 0,4 μ m (16 μ in.). Gold plating Socket: 0,75 μ m (30 μ in.).

† Gold plating Pin & Socket: 0,30 μ m (120 μ in.).

Machined Earth (First Mate/Last Break) Contacts

- 13 A current rating.
- Separate contact and retention spring.
- Up to 500 mating cycles.
- Variety of plating options.
- Full support tooling available, see page 53.



**Size 16 AWG,
No Insulation Grip**

**Size 20 to 26 AWG,
Insulation Grip**

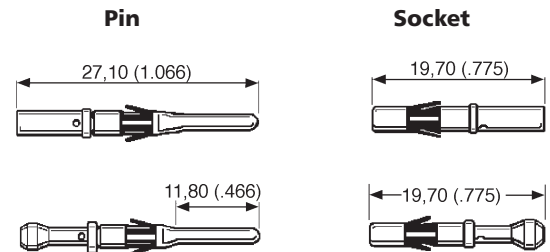

Contact	Part Number		Wire Range mm2	Wire Size	Insulation Diameter	Strip Length	Color Band
	Pack (100) Gold Plating*	Pack (100) Tin Plating					
Pin	192991-0164	192991-0160	0,44 - 0,64	20 AWG	1,60 (.062) - 2,10 (.082)	5,08 (.200)±0,25 (.009)	Green
Socket	192991-0207	192991-0208	0,44 - 0,64	20 AWG	1,60 (.062) - 2,10 (.082)	5,08 (.200)±0,25 (.009)	Green
Pin	192991-0160	192991-0160	0,60 - 1,51	16 AWG	Without insulation support	7,11 (.279)±0,25 (.009)	Black
Socket	192991-0208	192991-0208	0,60 - 1,51	16 AWG	Without insulation support	7,11 (.279)±0,25 (.009)	Black

* Gold plating Pin: 0,4 μ m (16 μ in.). Gold plating Socket: 0,75 μ m (30 μ in.).

Solder Cup Contacts

- 13 A current rating.
- Ideal for prototypes and small volume applications.
- Fits into all Trident connectors.
- Simple solder, then insert design. Socket/Pin.



Description	Part Number	
	Tin Plating	Gold Plating*
Socket	192900-0634	192900-0635
Pin	192900-0632	192900-0633

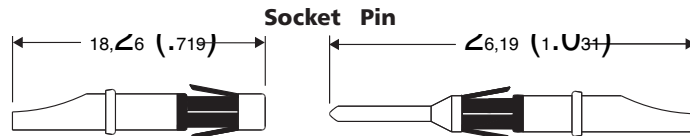

*Gold plating 0,4 μm (16 μin.)

Flow Solder (PCB) Contacts

- 13 A current rating.
- Available in different lengths depending on connector.
- Socket versions available.
- High Volume packaging available.
- 30 A power version available.

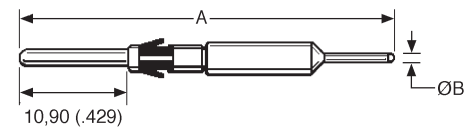

Connector Series	Part Number Pack of 100			
	Tin Plating	Gold Flash Plating	A ±1,07 (.003)	ØB
Ringlock Multiway	192991-0122	192991-0119	34,70 (1.366)	0,76 (.030)
Neptune	192900-0465	192900-0356	40,75 (1.604)	0,71 (.028)
Neptune Power**	192991-0617	192991-0618	40,60 (1.598)	1,50 (.059)

** Note appearance differs slightly from the picture.

Power Contacts

- 30 A current rating.
- For use with Neptune connectors.



Contact	Part Number		Wire Range mm2	Wire Size	Insulation Diameter	Strip Length
	Loose (100) Tin Plated	Reeled (3000) Tin Plated				
Pin	031-8717-020	121668-0000	0,50 - 1,00	20-18 AWG	1,40 (.055) - 2,00 (.078)	5,00 (.196)±0,25 (.009)
Socket	031-8717-120	121668-0100	0,50 - 1,00	20-18 AWG	1,40 (.055) - 2,00 (.078)	5,00 (.196)±0,25 (.009)
Pin	031-8717-021	121668-0001	1,50 - 2,50	16-14 AWG	2,00 (.078) - 2,90 (.114)	5,00 (.196)±0,25 (.009)
Socket	031-8717-121	121668-0101	1,50 - 2,50	16-14 AWG	2,00 (.078) - 2,90 (.114)	5,00 (.196)±0,25 (.009)
Pin	031-8717-022	121668-0002	2,50 - 4,00	14-12 AWG	2,90 (.114) - 3,60 (.141)	5,00 (.196)±0,25 (.009)
Socket	031-8717-122	121668-0102	2,50 - 4,00	14-12 AWG	2,90 (.114) - 3,60 (.141)	5,00 (.196)±0,25 (.009)



Dimensions shown in mm (inch)
Specifications and dimensions subject to change

www.ittcannon.com

Coaxial Contacts

- Up to 200 mating cycles.
- Fits all Trident contact cavities.
- Full range of tooling available.
- For twisted pair and coaxial cable use.
- All contact assemblies sold in packs of 100.



Performance Specifications

Temperature Range	-55°C to 125°C
Operating Voltage	230 V dc

Materials and Finishes

Description	Material	Finish
Inner Contact	Brass	0,75 μm (30 μ in.) Gold
Outer Contact	Brass	0,40 μm (16 μ in.) Gold

Outer Female Contact Assembly

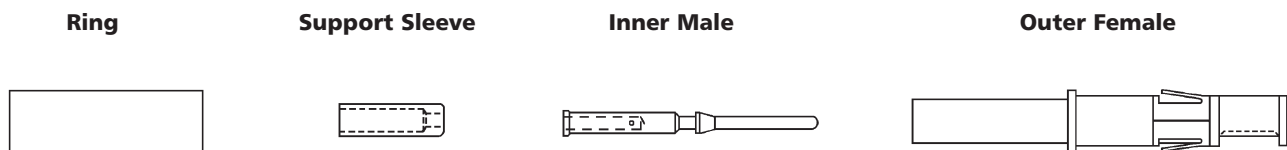

Outer Male Contact Assembly

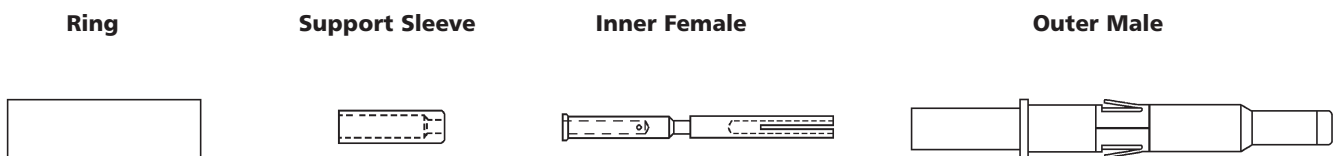

Description	Part Number (Pack of 100)	Nomenclature	Cable Type*
Outer Female Contact Assembly	192945-4380	TC1FCLY	A**
Outer Male Contact Assembly	192945-4390	TC1MCLY	A**
Outer Female Contact Assembly	192945-4930	TC2FCLY	B and Twisted Pair
Outer Male Contact Assembly	192945-4530	TC2MCLY	B and Twisted Pair

Note: Sold as complete sets. Please contact Cannon for other packaging options.
 *For Cable Type, see page 50.
 **Support sleeve not used.

Coaxial Contacts — Cable Type and Cable Strip Length

Cable Type — A

T3203	T3306	RG174
T3204	T3385	RG179
T3264	T3388	RG187
T3289	T3390	RG188
		7528A/31

Cable Type — B

T3201	T3293	RG178
T3202	T3294	RG196
T3261	T3386	7530A/1114
T3263	UR94	5088A/1317
	LN00029	7530D/1114
	C06C030	LGRZ/4016

Cable Type — Twisted Pair Insulation

Diameter	Dimension	
	X	Y
0,56 (.022) - 1,12 (.044)	4,80 (.189)	6,30 (.248)
Less than 0,56 (.022)	5,10 (.200)	13,00 (.512)

Outer Male Contact Assembly

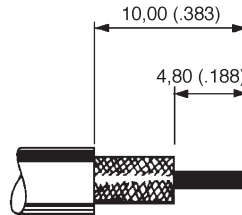

Part Number: 192945-4580

Outer Male Contact Assembly

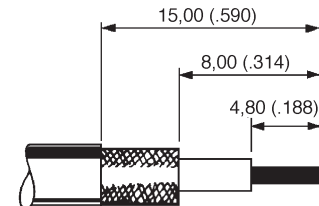

Part Number: 192945-4590

Outer Male Contact Assembly

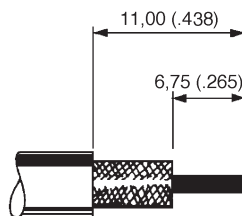

Part Number: 192945-4530

Outer Male Contact Assembly

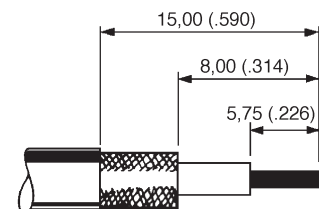

Part Number: 192945-4530

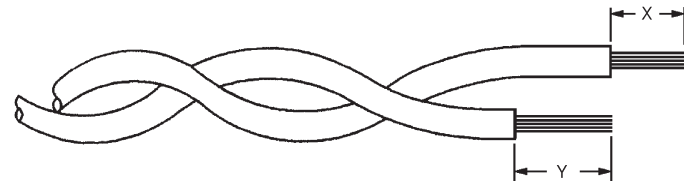

Part Number: 192945-4930 & 192945-4530



Discriminating (Keying) Pins and Caps

Discriminating (Keying) Pins are used to prevent cross-mating of similar connectors. These pins are used in place of a pin contact. The corresponding socket cavity must be left open. If a socket contact is present, the discriminating pin will prevent mating. There are two types of discriminating pins. Board Mount PCB connectors have caps and pegs. All other connectors have signal or power pins.

Description	Part Number	Pack Size
Discriminating (Keying) Pin, Signal Contacts	192990-0000	Bulk Pack (25)
Discriminating (Keying) Pin, Power Contacts	192900-0189	Bulk Pack (25)
Discriminating (Keying) Pin, Pin Contacts	192990-0010	Bulk Pack (100)
Discriminating (Keying) Cap, Socket Contacts	192990-7650	Bulk Pack (100)



Hand Tools For Formed (Stamped) Contacts

Low Cost Tool

This tool is recommended for prototype and low volume applications. It supports the full range of stamped contacts

Stamped Signal Contacts	Part Number
14-26 AWG	192922-1440



Ratcheted Hand Tool

A range of single action, factory calibrated tools are available to support the stamped contacts and 30 A power contacts.

Signal Contact	Power Contact	Part Number
14-16 AWG	N/A	112108-0013
16-18, 20-22, 24-26 AWG	N/A	112108-0014
16-18 AWG	12-14 AWG	112108-0011
N/A	14-16, 18-20 AWG	112108-0012



Hand Tools For Machined and Coaxial Contacts

This is a ratcheted, four indent crimp tool that is fully adjustable. They crimp all sizes of machined and coaxial contacts.

- MIL-C-22520 1/01*

Description	Hand Tool Part Number	Locator
Machined Crimp*	192990-2050	192990-7600 (Calibrated)
Machined Crimp*	192990-2050	192933-8470 (Low Cost)
Coaxial Outer	274-7613-000	326-7512-000
Coaxial Inner	995-0001-584	326-7511-000

Dimensions shown in mm (inch)
Specifications and dimensions subject to change

Automatic Tools

Mini Applicators



Mini Applicators are interchangeable modules that will fit into many standard crimping machines. They are available for all sizes of stamped signal and power contacts.

Contact Description	Part Number
14-16 Trident Signal	193800-0029
16-18 Trident Signal	193877-5630
20-22 Trident Signal	193877-5640
24-26 Trident Signal	193877-5640
12-14 Trident 30 A Power	193800-0023
14-16 Trident 30 A Power	193800-0024
18-20 Trident 30 A Power	193800-0031

Crimper/Stripper Systems

ITT offers a wide range of automatic crimping and stripping systems. These systems will support all of the stamped and machined contacts. Contact ITT for details.

Crimper/Stripper for Formed (Stamped) Contacts



Vibra-Bowl Crimper for Machined Contacts



Installation Tools

No installation tooling is required for Neptune. The force needed to insert contacts into the housings is very low and a light push on the wire is sufficient to snap the contact into position. Stitching tools are optional assembly aids for Neptune and TNM connectors. These tools puncture the membrane seal and guide contacts into place. They are not required for assembly, but many customers find that they reduce assembly time.

Description	Part Number
Signal Sockets	192900-0606
Signal Pins	192900-0605
Power Sockets	192900-0608
Power Pins	192900-0607



Extraction Tools

Contacts can readily be removed from the housings using an extraction tool. The tool is placed over the contact and the sleeve rotated slightly as it is pushed home to release the spring. Light pressure on the knob then ejects the contact from the rear of the housing.

Description	Part Number
Signal	192922-1450
Power	192900-0176



Crimping Instructions — Formed (Stamped) Crimp Contacts

Assembly Instructions:

- Strip wires to length. For wire strip lengths, see page 48.
- Open the hand tool and place the contact in the chosen die, ensuring that the locating plate is positioned between the collar and crimp saddle. Then squeeze tool gently to hold the contact in place.
- Insert the wire.
- Cycle the tool.
- Remove the wire and inspect the crimp. The strands should be visible at both ends of the crimp. There should be no loose strands (see Figures 1-3). The contact should be co-linear with the wire (see Figure 4). Bent contacts are unacceptable (see Figure 5).

Figure 1 - Correct

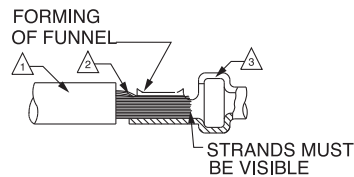

Figure 2 - Unacceptable

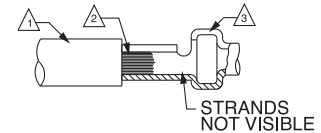

Figure 3 - Unacceptable

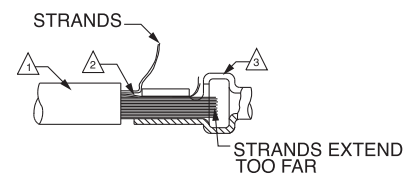

Figure 4 - Correct

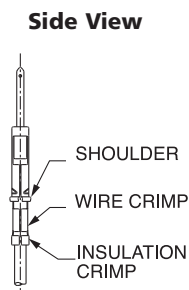

Figure 4 - Correct, Front View

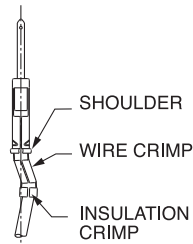

Figure 5 - Unacceptable

Figure 5 - Unacceptable, Side View

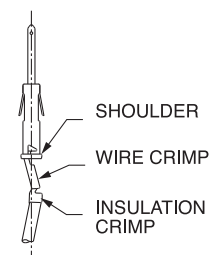
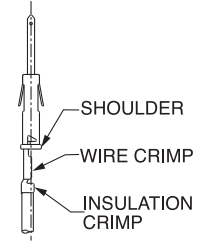

Figure 5 - Unacceptable, Front View



Crimping Instructions — Machined Crimp Contacts

Assembly Instructions:

- Strip wires to length. For wire strip lengths, see page 47.
- Attach the correct locator (turret) to the hand tool.

Contact Type	Locator Color
Pin	Blue
Socket	Green
Earthing	Black

- Adjust the dial for the wire gauge.
- Place the contact into the locator and insert the wire into the contact as indicated on the locator (turret) label.

Figure 6 - Correct

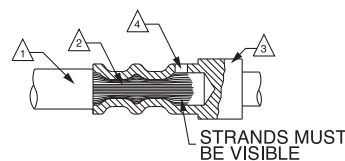
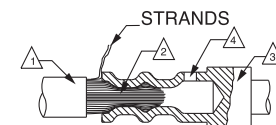

Figure 7 - Unacceptable



Notes:

- △ Wire Insulation.
- △ Wire Strands.
- △ Contact.
- △ Inspection Window. Strands must be visible.

Contact Insertion

No insertion tool is required. Trident contacts are inserted from the rear of the connector and held in place by retention tines (cantilever springs). These tines compress during insertion. They expand once contact is in place and prevent the contact from backing out.

Proper Insertion of Trident Contact

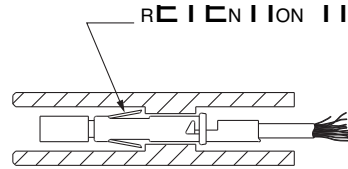

Contact Retention Forces

- Minimum retention force of the contact to the insulator.

Contact	Newton(s)
Signal Contacts	67
(Formed Crimp, Machined Crimp, Solder Cup, Flow Solder)	
Coaxial Contacts	67
30 A Power Contacts	100

Note: Newton is a metric unit of force. One pound = 4.45 Newtons

Trident Assembly Instructions (For Neptune and TNM Assembly, see page 55)

Assembly instructions:

1. Grasp the crimped or soldered contact just behind where the wire enters the contact.
2. Push the contact into the connector cavity until it locks into place.
3. Pull on the wire slightly to verify that the contact is secure.
4. Inspect the mating face of the connector. The contacts should extend the same distance into the connector

Contact Insertion - Slimline

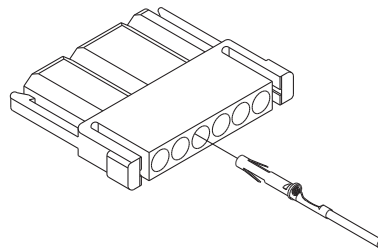

Contact Insertion - Ringlock

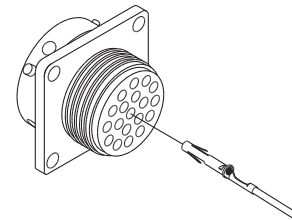

Neptune and TNM Assembly Instructions (For Trident Assembly, see page 54)

Neptune and TNM connectors feature membrane seals. These seals have a thin membrane that seals unused contact cavities. No sealing plugs are required for unused cavities. Neptune connectors do not require insertion tools. Cannon offers stitching tools as an optional assembly aid for high volume usage. Many customers find that stitching tools reduce the assembly time.

Assembly Instructions:

1. On Neptune and TNM connectors do not remove the Securing Nut holding the Wire Seal in place, unless an accessory such as Metal Endbell, Conduit Adapter, HC or SR Clamp assembly is to be used in its place. Then remove the Securing Nut (to be replaced by the accessory), make sure the tab on the Seal is positioned in the receiving slot in the connector, fit the accessory over the cables/wires and proceed as follows.
2. Grasp the crimped or soldered contact just behind where the wire enters the contact. If using a stitching tool, insert the contact into the rear of the tool.
3. Push the contact through the membrane seal into the insulator. Continue to push until the contact locks into place. If using a stitching tool, first insert the tool into the required contact position in the seal and examine the mating face to confirm that the correct contact cavity has been entered, if not, this can be corrected by partially removing the tool and engaging the correct position. Then fit the contact to the stitching tool and push the CONTACT through until it locks into place; remove the stitching tool.

Contact Insertion For Neptune and TNM Connectors

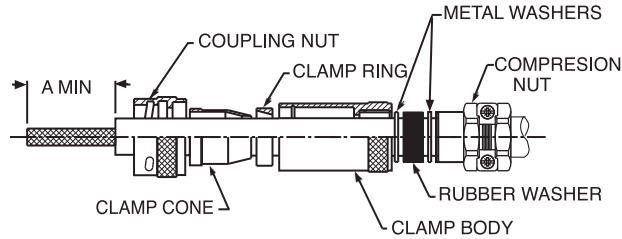

- IMPORTANT NOTE:** The stitching tool is not designed to pull the contact through; it is intended to ease the insertion process with high density connectors. On the high density connectors, such as 0-48, it is beneficial to start loading contacts on a center row first and filling adjacent rows fully each side, so progressively filling the connector from the center in a controlled manner.
4. Pull on the wire slightly to verify that the contact is secure.
 5. Inspect the mating face of the connector. The contacts should extend the same distance into the connector.
 6. Secure the nut, or other accessory, to hold the membrane seal in place.

Contact Extraction

Contacts may be removed with an extraction tool. The tool has an outer tube and an internal spring loaded plunger. The outer tube depresses the retention tines on the contact. The plunger then pushes the contact back out of the connector.

Extraction Instructions:

1. Grasp the extraction tool on the knurled portion of the outer tube. Do not push on the plunger knob yet.
2. Insert the tube into the contact cavity from the mating surface. Push the tube fully into the cavity.
- IMPORTANT:** Verify that the depth indicating line on the tool is even with the mating face of the connector before depressing the plunger.
3. Depress the plunger. This should only require light pressure to eject the contact. The contact can now be removed from the back of the connector.
4. Inspect the contact. Verify the tines are not damaged.

Contact Extraction

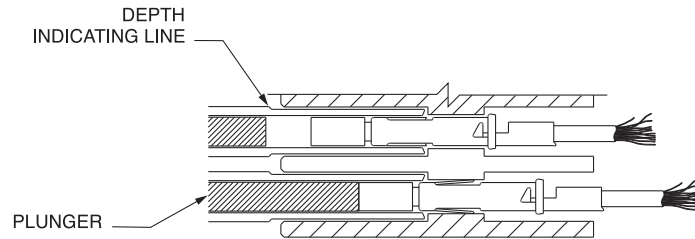

Extraction Tool

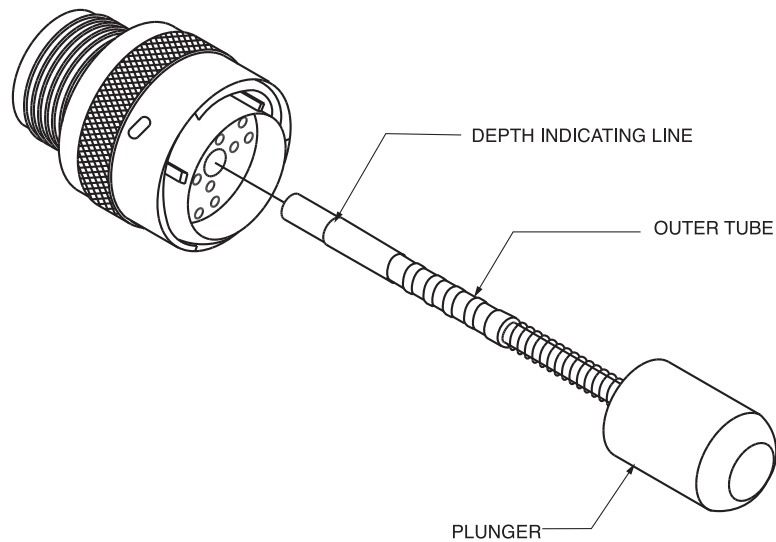

Endbell — Unsealed

Assembly Instructions:

1. Separate the body of the clamp, the two screws, and the clamping bar.
2. Slide the body over the wires or cable and screw onto the threads on the back of the connector. The backshell should be hand-tight. For Neptune and TNM connectors, the cable clamp will fit over the membrane seal and will hold it in place.
3. There are three clamp bars supplied. Select the appropriate one for the wire bundle and attach to the clamp body with the screws.

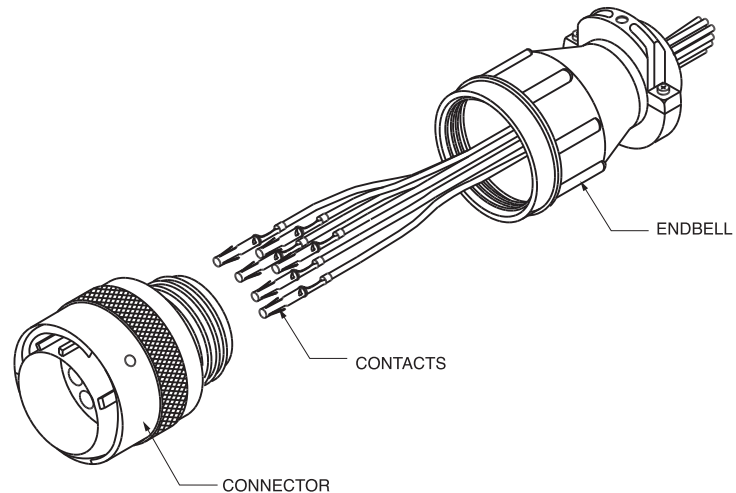

Endbell — Sealed

Assembly Instructions:

1. Separate the body of the clamp body, the two pressure rings, the sealing grommet, the clamp, and O-ring.
2. Slide the backshell components over the cable prior to crimping the contacts and assembling the connector. The farthest part from the connector is the clamp, followed by a pressure ring, then the grommet, then the other pressure ring, then the clamp body and then the O-ring.

Assembly Note: The grommet is a layered design. For large cables one or more of the interior sections can be removed. If the grommet resists sliding over the cable, lubricate with isopropyl alcohol.

3. Crimp and insert the contacts.
4. Slide the O-ring up and over the back of the connector.
5. Screw the clamp body onto the back of the connector. It should be hand-tight. For Neptune and TNM connectors, the cable clamp will fit over the membrane seal and will hold it in place.
6. Slide the pressure rings and grommet forward into the body.
7. Screw the cable clamp into the clamp body. The cable clamp will apply pressure to the grommet causing it to seal the backshell to the cable.
8. Screw down the clamp bar to secure the cable. Note that the bar is reversible, depending on the size of the cable.

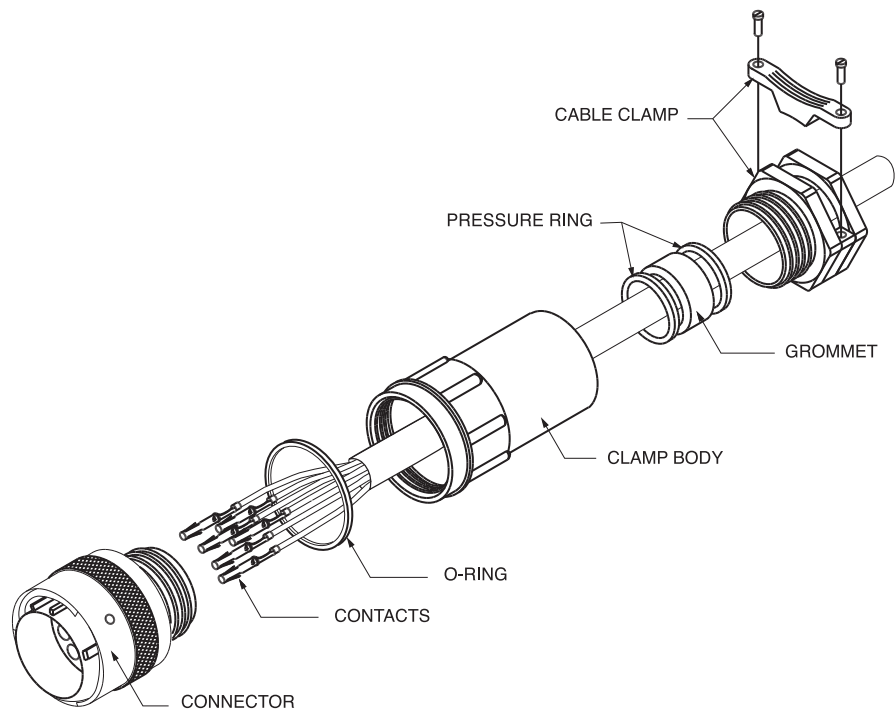

Universal Endball

Universal Endbell Assembly

The Universal Endbell is suitable to accept shielded and unshielded cable. This cable is sealed with a highly flexible seal and an additional sealing ring with a flexible plastic cable clamp serving as a strain relief. The Universal Endbell can be screwed onto plug and receptacle connectors. The O-ring and the cable sealing meet IP67.

Assembly Instructions:

1. Slide O-ring over the back of the connector body.
2. Slide the endbell components onto the cable in the following order:

- Clamp Nut
- Cable Grip1
- Cable Seal2
- Housing
- Grounding Ring
- Support Sleeve
- O-Ring

Note: 1. The compression fingers of the Cable Grip face toward the connector.

Note: 2. Isopropyl alcohol will lubricate the Cable Seal making it easier to slide over the cable.

3. Cut back the Outside Jacket to expose 25,40 (1.000) of Braid followed by 12,70 (.500) of Insulated Wires.
4. Terminate the wires and insert contacts per assembly instructions, see page 45.
5. Slide the Support Sleeve down until it reaches the back of the connector.
6. Pull the Braid over the Grounding Ring.
7. Slide the Grounding Ring down until it snaps onto the Support Sleeve. The Braid should be secured between the Support Sleeve and the Grounding Ring. Fold any excess shielding over the Grounding Ring.
8. Slide the Housing over the Grounding Ring and the Support Sleeve and screw it into the connector body. The recommended torque is 10 ± 1 Nm (88.50 in lbs).
9. Slide the Cable Seal and Cable Grip onto the Housing.
10. Tighten the Clamp Nut into the Housing. The recommended torque is 10 ± 1 Nm (88.50 in lbs).

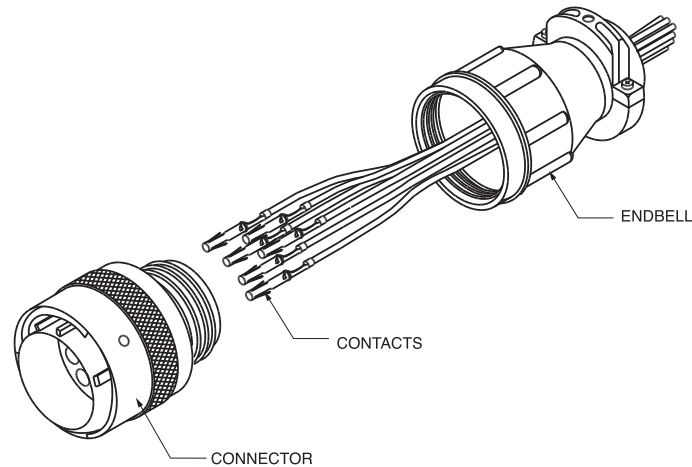

Wire Strip Length

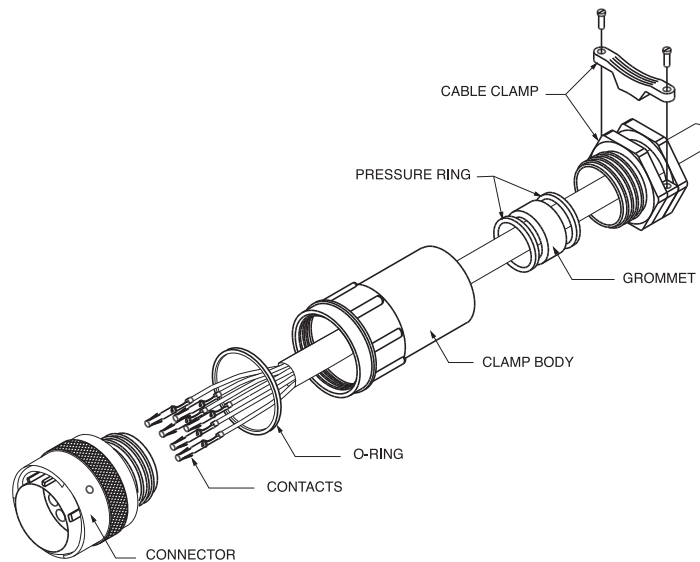

Shell Size	Wire Strip Length		
	A	B	C
10	38,00 (1.500)	22,00 (.870)	*
12	38,00 (1.500)	22,00 (.870)	*
14	40,00 (1.600)	24,00 (.950)	*
16	40,00 (1.600)	24,00 (.950)	*

* Strip length will vary based on the contact selected, see page 45.

Shielded Endbell for Larger Cable Sizes

This Endbell is an alternative to the Universal Endbell for use with larger diameter cables. The outer body is sealed to the connector with an O-ring and the rear cable clamp also incorporates sealing rings for a complete sealed termination. The cable braid is terminated between metal cones. A rear cable clamp provides mechanical strain relief in addition to the clamping and holding of the rear cable seal.

Assembly Instructions:

1. Assemble all parts onto the cable as shown (Figure 1). Strip sheath of cable to dimensions shown in table below.

Shell Size	Dimension A min.
10	22,30 (.877)
12	22,30 (.877)
14	26,20 (1.031)
16	28,10 (1.106)

2. Fold braid back over cable. Strip and terminate wires with selected contacts (Figure 2).

3. Assemble O-ring in groove of the shell after positioning coupling nut (Figure 3).

Figure 1

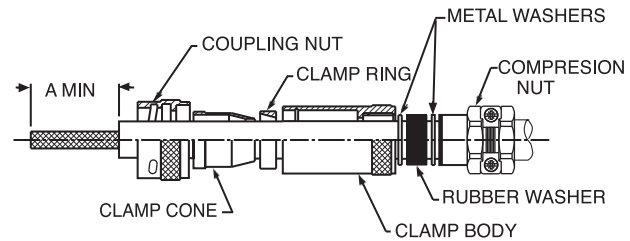
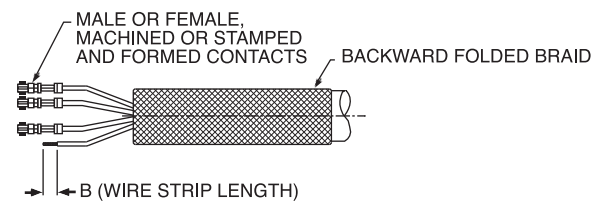

Figure 2



Wire Stripping Lengths

Contact Type	Wire Size	Wire Range mm2	Dimension B
Formed contact	24-16 AWG	0,08 - 1,50	3,95 ± 0,25 (.155 ± .009)
	14 AWG	1,50 - 2,50	5,60 ± 0,25 (.220 ± .009)
Machined contact	26-20 AWG	0,08 - 0,64	5,08 ± 0,25 (.200 ± .009)
	16 AWG	0,60 - 1,51	7,11 ± 0,25 (.279 ± .009)

Figure 3

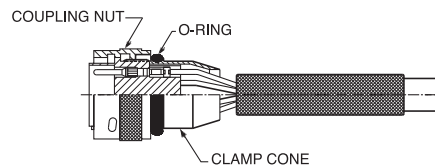

Cable Sizes

Shell Size	Endbell Part Number	Cable Outer Sheath Diameter	
		Maximum	Minimum
10	192993-0091	10,00 (.393)	5,00 (.196)
12	192993-0092	12,00 (.472)	6,00 (.236)
14	192993-0093	14,00 (.551)	7,00 (.279)
16	192993-0094	16,00 (.629)	8,00 (.314)

Shielded Endbell for Larger Cable Sizes (continued from page 59)

4. Fold braid forward as shown and trim to length (Figure 4).

5. Slide on clamp ring in position shown (Figure 5).

6. Screw clamp body onto the connector using a strap wrench (Figure 6). Tighten to the recommended torque values in table below.

Shell Size	Clamp body Torque max.
10	4 Nm
12	6 Nm
14	10 Nm
16	10 Nm

7. Push metal washers and rubber washer into rear of clamp body. Then screw compression nut to compress rubber washer. Avoid overtightening as this may twist the cable. Finally tighten screws to provide the mechanical strain relief (Figure 7).

8. Assembled connector (Figure 8).

Figure 4

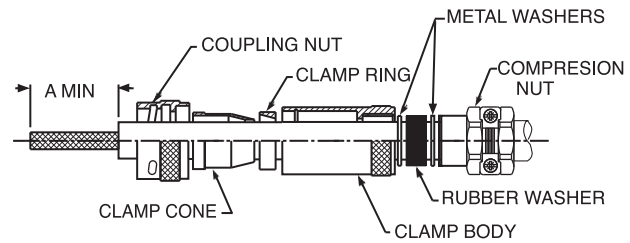

Figure 5

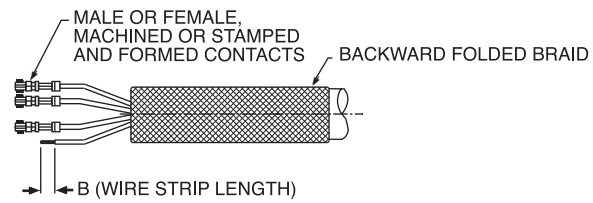

Figure 6

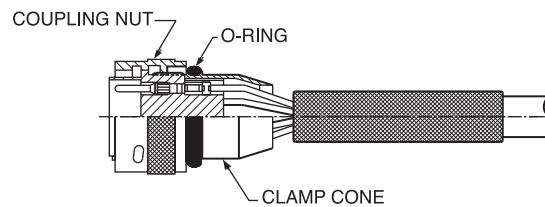
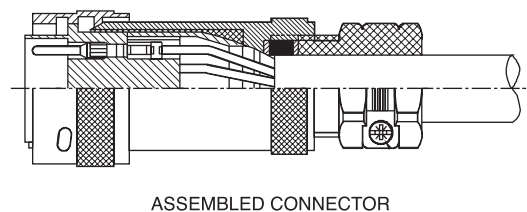

Figure 7



Notes

Dimensions shown in mm (inch)
Specifications and dimensions subject to change

www.ittcannon.com



Chart 1 International Protection (IP) ratings for IEC 529

First digit of IP Number – Ingress of foreign objects		Second digit of IP Number – Ingress of water									
		IP 0	IP 1	IP 2	IP 3	IP 4	IP 5	IP 6	IP 7	IP 8	
	Meaning for the protection of equipment against ingress of solid foreign objects	Meaning for the protection of persons against access to hazardous parts with	non-protected	Protected against vertically falling water drops	Protected against vertically falling water drops when device is tilted up to 15°	Water sprayed an angle up to 60° on either side of the vertical shall have no harmful effects	Water splashed from any direction shall have no harmful effects	Water projected in jets from any direction shall have no harmful effects	Water projected in powerful jets from any direction shall have no harmful effects	Protected against temporary immersion	Protected against continuous immersion
IP 0	non-protected	non-protected	IP 00								
IP 1	Protected against solid foreign objects larger in diameter than 50mm (1.97 in)	Protected against access to hazardous parts with the back of the hand	IP 10	IP 11	IP 12						
IP 2	Protected against solid foreign objects larger in diameter than 12.5mm (.49 in)	Protected against access to hazardous parts with a finger	IP 20	IP 21	IP 22	IP 23					
IP 3	Protected against solid foreign objects larger in diameter than 2.5mm (.10 in.)	Protected against access to hazardous parts with a tool larger in diameter than 2.5mm (.10 in.)	IP 30	IP 31	IP 32	IP 33	IP 34				
IP 4	Protected against solid foreign objects larger in diameter than 1.0mm (.04 in.)	Protected against access to hazardous parts with a wire larger in diameter than 1.0mm (.04 in.)	IP 40	IP 41	IP 42	IP 43	IP 44				
IP 5	Ingress of dust is not totally prevented, but dust shall not penetrate in a quantity to interfere with satisfactory operation of the apparatus or to impair safety	Protected against access to hazardous parts with a wire larger in diameter than 1.0mm (.04 in.)					IP 54	IP 55			
IP 6	No ingress of dust	Protected against access to hazardous parts with a wire larger in diameter than 1.0mm (.04 in.)							IP 66	IP 67	IP 68

Chart 2 NEMA / IP Cross Reference

IEC 529 Protection Ratings	NEMA Ratings									
	1	2	3	3R	4	4X	5	6	12	13
IP 00										
IP 10	↓									
IP 11		↓								
IP 20										
IP 21										
IP 22										
IP 23										
IP 30										
IP 31				↓						
IP 32										
IP 33										
IP 40										
IP 41										
IP 42										
IP 43										
IP 50										
IP 51							↓			
IP 52										
IP 53										
IP 54									↓	↓
IP 55										
IP 56										
IP 60										
IP 61										
IP 62										
IP 63			↓							
IP 64										
IP 65										
IP 66										
IP 67					↓	↓				
IP 68								↓		

The chart above provides a cross-reference from NEMA to International Protection (IP) Ratings. This cross-reference is an approximation based on the most current information available. It is not sanctioned by NEMA, IEC, or any other regulatory body. This chart should be used only as a guideline.

GLOSSARY OF TERMS

In every job speciality there are certain words and phrases used by “insiders” which after a time become almost a language unique to that speciality. Trident technology is a typical example of that condition.

This page provides some explanations, in an attempt to clarify some of the terms that are commonly used by engineers and sales staff at Cannon.

The list is not comprehensive, but highlights many of the expressions commonly used. Should you have any comments or additions please contact us. Feedback will be appreciated.

ADAPTER – A device used to modify the accessory threading on the rear of the connector. Typical adapters are used to attach conduit, heat shrink, overmolds, or tubing to the connectors. They are generally used in place of a cable clamp.

AWG – American Wire Gauge. A method of specifying wire diameter. The higher the number, the smaller the diameter (a size 16 AWG wire has a larger diameter than a size 22 AWG).

BAYONET COUPLING – A quick coupling mechanism for mechanically mating and unmating connector halves. The plug half has a coupling nut with internal ramps and the receptacle has three “bayonet” pins. The two halves are mated and unmated by rotating the coupling nut. The two halves are mated and unmated by rotating the coupling nut.

BACKSHELL – See ENDBELL.

BODY - The main portion of the connector made of the shell, insulator, and contacts.

CABLE CLAMP – A rear connector clamping accessory which tightens over a cable or wire bundle to provide strain relief to the cable. The cable clamp may be part of a more elaborate endbell or it may be used alone. Some cable clamps also provide cable jacket sealing using a resilient gland, others provide only strain relief.

CABLE SEAL – An endbell or cable clamp that is used to seal a round jacketed cable as it enters the rear of the connector.

CONTACT – The conductive element in a connector which makes the actual connection between the wire and the mating connector for the purpose of transferring electrical energy. Ideally the contact should add nothing to the circuit. In the real world, however, contacts typically have a small CONTACT RESISTANCE and associated potential drop. Contacts come in many styles such as solder, crimp, printed circuit (PC), to name just those found in this catalog. Also see SOLDER CONTACT, CRIMP CONTACT, STAMPED AND FORMED CONTACT, PIN CONTACT, and SOCKET CONTACT.

CONTACT ALIGNMENT – The overall play that a contact has in the insulator cavity to allow the mating contacts to self align. Also called contact float.

CONTACT ARRANGEMENT – See LAYOUT.

CONTACT CAVITY – A defined hole in the connector insulator into which the contacts fit. The cavities are generally marked with a unique designation or number for ease of identification.

CONTACT RESISTANCE – The maximum amount of resistance which a contact introduces into the connection when carrying a specified current (usually stated in milliohms). When not stated, values are typically given for “Initial” or new contacts. Most specifications also limit the maximum resistance during or after each of a series of extreme tests, such as “Contact Resistance After Corrosion Test”. These figures are typically slightly higher than “Initial”.

CONTACT RETENTION – The maximum allowable axial load which can be applied to a contact from either direction without it being dislodged from the insulator. Usually stated in Newtons or pounds of force (4.45 = 1 lbf).

CONTACT SEPARATION FORCE – The force required to separate a pair of mated contacts. Usually stated in grams or ounces.

CONTACT SIZE – The size of the engaging pin and socket contacts in AWG size or metric diameter of the pin.

CONTACT SPACING – The distance between two centers of adjacent contacts.

COUPLING NUT (Also known as LOCKING RING) - The rotating ring on plug style connectors which mechanically locks the two connector halves together.

CRIMP CONTACT – A contact which is terminated to a wire by means of mechanical deformation of the receiving area by means of an appropriate tool.

CSA – Abbreviation for Canadian Standards Association.

CURRENT RATING – The maximum current that a particular wire, contact, or connector can accommodate. NOTE: When several wires are used in a single connector or elevated temperature or altitude is involved, derating curves must be applied to these ratings.

DERATING CURVE – A graph of the change in power handling capability of a connector as a function of ambient temperature or altitude. Typically the graphed function is curved, hence the name.

DISCRIMINATION – A method of ensuring that two similar size connectors cannot be mated. This may be achieved by inclusion of discriminating pins, which enter an empty contact cavity, or by other mechanical means.

DISCRIMINATING PINS – See KEYING.
ENDBELL (also known as BACKSHELL) – The outer rear end of the connector, which is attached by means of internal threads or screws. It adapts the connector to its wire connections in a variety of ways. Typical endbells might have cable clamps to secure a wire bundle, ridges for heat shrink tubing, pipe threads, or shield termination mechanisms.

EXTRACTION TOOL – A device used to remove a contact from a connector insulator. The extraction tool is inserted into the mating face of the insulator and the contact comes out the rear, or wire side, of the connector.

FIRST-MAKE LAST-BREAK CONTACT – A contact which is longer than a standard contact or which sits in the insulator in such a way that it mates with the opposing connector half before any of the other contacts. Used to ensure that a ground connection between the connector halves mates before any of the other contacts.

FLANGED RECEPTACLE – The shell of this connector has a square flange with mounting holes at each corner. Mounting holes are usually clearance holes, but may be threaded. Receptacle flanges may be mounted in front or at the rear of the panel.



FLASH PLATING. – As commonly used in connector terminology, flash refers to extremely thin platings of metal. A flash plating is the minimum thickness required to ensure complete surface coverage. It is typically used on contacts that will have only occasional mating and unmating.

IEC – Abbreviation for the International Electrotechnical Commission. An international organization, which develops standards exclusively for electrical engineering. CENELEC is the equivalent organization at the European level.

INSULATOR – The insulating element into which the contacts are mounted in a connector.

IP67 - One classification from a rating system used in Europe covering the environmental sealing capability of an enclosure. The system uses two digits, the first digit relates to the degrees of protection the connector has from dirt and dust under the conditions defined in the specification. The second digit relates to the degrees of protection it has against moisture. The degree of protection against dirt ranges from 1 (no protection), to 6 (dust tight). Moisture sealing in the specification ranges from 1 (no protection), to 8 (protected against continuous submersion). The classification IP67 states that the connector is "dust-tight" (6), allowing no ingress of dust what-so-ever, and "protected against the effects of immersion" (7), the ingress of water in harmful quantity shall not be possible when the connector is immersed in water under defined conditions of pressure and time.

JAM NUT RECEPTACLE – A receptacle connector that is mounted from the rear side of the panel and is held in place by a large hex nut (jam nut).

KEYING – A method of differentiating a connector if more than one connector with the same sex and layout is to be used in a system. The key is a pin which can be located in a contact cavity or slot. The key will prevent a connector without a matching orifice from mating.

LAYOUT – The number, size, and geometric arrangement of the contacts in a connector. When a connector is said to have a certain "layout" it refers to a specific contact configuration. For example, the Snap Together Connector series has a page of drawings showing the arrangement of the contacts in the insulator. Each of these arrangements can be referred to as a layout.

LOCKING RING – See COUPLING NUT.

PIN CONTACT – The contact that has a long shaft at the engagement end which enters the socket contact.

PLUG – The male portion of the connector pair usually employing a coupling nut to secure it to the receptacle half. A Plug may have either pin or socket contacts.

POLARIZATION – Polarization ensures that connector halves engage in such a way that the identified contact cavities always engage each other, A to A etc. The connector is polarized.

POLARIZING PIN – See KEYING.

REAR MOUNTING – A receptacle that mounts through the panel from the rear, with its mounting flange inside the equipment. Typically, rear mount receptacles are slightly longer than front mount types to allow for the thickness of the panel. Flange mount receptacles usually come in front and rear mount versions. All Jam nut receptacles are rear mount.

RECEPTACLE – The connector which mates with the plug. The receptacle has threads, pins or ramps that engage the coupling nut on the plug, locking the two halves together. A receptacle may have either pin or socket contacts.

SHELL – The outside case of a connector into which the insulator and contacts are situated.

SHELL SIZE – A standard system developed for military circular connectors for indicating the diameter of the shell. The system is based upon 1/16" increments, that is, a size 16 shell is one inch in diameter.

SOCKET CONTACT – The contact that has an opening at the engagement end to accept the pin contact.

SOLDER CONTACT – A contact that is terminated to the wire or printed circuit with solder. The alternative is crimp contacts to which a wire is attached by crimping.

SOLDER CUP – The end of a SOLDER CONTACT designed to accept a wire, which will then be soldered to the contact.

STAMPED AND FORMED CONTACT – Contacts made by stamping and forming a sheet of metal rather than by machining metal stock.

UL – Abbreviation for Underwriter's Laboratories, a corporation supported by a group of underwriters for the purpose of establishing safety standards covering certain types of equipment and components in the United States. Product Safety Information

THIS NOTE MUST BE READ IN CONNECTION WITH THE PRODUCT DATA SHEET/CA T A LOG. FAILURE TO OBSERVE THE ADVICE IN THIS INFORMATION SHEET AND THE OPERATING CONDITIONS SPECIFIED IN THE PRODUCT DATA SHEET/CA T A LOG COULD RESULT IN HAZARDOUS SITUATIONS.

1. MATERIAL CONTENT AND PHYSICAL FORM

Electrical connectors do not usually contain hazardous materials. They contain conducting and non-conducting materials and can be divided into two groups.

- a) Printed circuit types and low cost audio types which employ all plastic insulators and casings.
- b) Rugged, fire Barrier and High Reliability types with metal casings and either natural rubber, synthetic rubber, plastic or glass insulating materials. Contact materials vary with type of connector and also application and are usually manufactured from either: copper, copper alloys, nickel, alumel, chromel or steel. In special applications, other alloys may be specified.

2. FIRE CHARACTERISTICS AND ELECTRIC SHOCK HAZARD

There is no fire hazard when the Connector is correctly wired and used within the specified parameters. In correct wiring or assembly of the Connector or careless use of metal tools or conductive fluids, or transit damage to any of the Component parts may cause electric shock or burns. Live circuit must not be broken by separating mated Connector as this may cause arcing, ionization and burning. Heat dissipation is greater at maximum resistance in a circuit. Hot spots may occur when resistance is raised locally by damage, e.g. cracked or deformed contacts, broken strands of wire. Local overheating may also result from the use of the incorrect application tools or from poor quality soldering or slack screw terminals. Overheating may occur if the ratings in the product Data Sheet/catalog are exceeded and can cause breakdown of insulation and hence electric shock. If heating is allowed to continue it intensifies by further increasing the local resistance through loss of temper of spring contacts, formation of oxide film on contacts and wires and leakage currents through carbonization of insulation and tracking paths. Fire can then result in the presence of combustible materials and this may release noxious fumes. Overheating may not be visually apparent. Burns may result from touching overheated components.

3. HANDLING

Care must be taken to avoid damage to any component parts of electrical connectors during installation and use. Although there are normally no sharp edges, care must be taken when handling certain components to avoid injury to fingers. Electrical connectors may be damaged in transit to the customers, and damage may result in creation of hazards. Products should therefore be examined prior to installation/use and rejected if found to be damaged.

4. DISPOSAL

Incineration of certain materials may release noxious or even toxic fumes.

5. APPLICATION

Connectors with exposed contacts should not be selected for use on the current supply side of an electrical circuit, because an electric shock could result from touching exposed contacts on an unmated connector. Voltages in excess of 30 V ac or 42.5 V dc are potentially hazardous and care should be taken to ensure that such voltages cannot be transmitted in any way to exposed metal parts of the connector body. The connector and wiring should be checked, before making live, to have no damage to metal parts or insulators, no solder blobs, loose strands, conducting lubricants, swarf, or any other undesired conducting particles. Circuit resistance and continuity check should be made to make certain that there are no high resistance joints or spurious conducting paths. Always use the correct application tools as specified in the Data Sheet/catalog. Do not permit untrained personnel to wire, assemble or tamper with connectors. For operation voltage please see appropriate national regulations.

IMPORTANT GENERAL INFORMATION

(i) Air and Creepage Paths/Operating Voltage. The admissible operating voltages depend on the individual applications and the valid national and other applicable safety regulations. For this reason the air and creepage path data are only reference values. Observe reduction of air and creepage paths due to PCB board and/or harnessing.

(ii) Temperature

All information given are temperature limits. The operation temperature depends on the individual application.

(iii) Other Important Information

Cannon continuously endeavors to improve their products. Therefore, Cannon products may deviate from the description, technical data and shape as shown in this catalog and data sheets.

“Engineered for life” is a registered trademark of ITT Industries. ©2005. All other trademarks or registered trademarks are property of their respective owners. All data subject to change without notice.

Product Warranty

ITT Cannon, a Division of ITT Industries, Inc. manufactures the highest quality products available in the marketplace; however these products are intended to be used in accordance with the specifications in this publication. Any use or application that deviates from the stated operating specifications is not recommended and may be unsafe. No information and data contained in this publication shall be construed to create any liability on the part of Cannon. Any new issue of this publication shall automatically invalidate and supersede any and all previous issues. A limited warranty applies to Cannon products. Except for obligations assumed by Cannon under this warranty, Cannon shall not be liable for any loss, damage, cost of repairs, incidental or consequential damages of any kind, whether or not based on express or implied warranty, contract negligence or strict liability arising in connection with the design, manufacture, sale, use or repair of the products. Product availability, prices and delivery dates are exclusively subject to our respective order confirmation form; the same applies to orders based on development samples delivered. This publication is not to be construed as an offer. It is intended merely as an invitation to make an offer. By this publication, Cannon does not assume responsibility or any liability for any patent infringements or other rights of third parties which may result from its use. Reprinting this publication is generally permitted, indicating the source. However, Cannon's prior consent must be obtained in all cases.



ITT... providing a comprehensive offering of connectivity solutions.

In addition to connector products, we provide a complete line of electronic components and value-added solutions.

CONNECTOR PRODUCTS

- circular
- compact flash
- D-Subminiature
- fiber optics
- filter
- Microminiature

- Mobile
- Rack & Panel
- RF
- USB
- Zero insertion force
- Smart cards



SWITCH PRODUCTS



- Top/side actuated tact
- Low profile SMT
- Navigation / scrolling switches
- Toggle, rocker, pushbutton, DIP, slide, snap, switchlock, rotary, thumbwheel

KEYPADS / PRECISION POLYMERS

- Rubber and In Mold Decoration (IMD) products
- Wide range of cosmetic options
- Integration of decorated and metalized plastic keytops
- Multiple PILL and contact options
- Precision molded polymeric solutions



DOME ARRAYS / EL LAMPS



- Modular assembly options include: ESD shielding, keypad arrays, EL backlighting, rigid or flexible circuits
- Complete design, engineering and test capabilities
- Low, mid and high volume production capabilities

INTERFACE CONTROLS

- From multi-function grips to sophisticated control systems, hall effect products and front panel assemblies
- Electronics and software engineering development
- Worldwide design and manufacturing
- High-mix production capabilities
- Global sourcing and supply chain management





Connector Product Locations

GERMANY

Cannonstrasse 1
Weinstadt, 71384
phone: 49.7151.699.0
fax: 49.7151.699.217

HONG KONG

Unit 901 & 912, West Tower
Shun Tak Center
168-200 Connaught Road
Central
phone: 852.2732.2720
fax: 852.2732.2919

ITALY

Via Pietro Panzeri 10
Milano, 20123
phone: 39.2.58180.1
fax: 39.2.8372036

UK

Jays Close, Viabes Estate
Basingstoke, RG22 4BA
phone: 44.1256.311200
fax: 44.1256.323356

USA

666 East Dyer Road
Santa Ana, CA 92705
toll free: 1.800.854.3028
phone: 1.714.557.4700
fax: 1.714.628.2142

"Engineered for life" is a registered trademark of ITT Industries. ©2005. All other trademarks or registered trademarks are property of their respective owners. All data subject to change without notice.

X-ON Electronics

Largest Supplier of Electrical and Electronic Components

Click to view similar products for [Circular DIN Connectors](#) category:

Click to view products by [ITT](#) manufacturer:

Other Similar products are found below :

[CTV06RQF-25-8SA-LC](#) [CTV06RQF-25-8S-LC](#) [CTV06RQW-25-8SB-LC](#) [CTV06RW-25-20P](#) [CTV06RW-25-20PA](#) [CTV06RW-25-20PB](#)
[CTV06RW-25-20PE-LC](#) [CTV06RW-25-20SB](#) [CTV06RW-25-20SE](#) [CTV07RW-17-8S\(506\)](#) [CTVP00RW-19-32S\(506\)](#) [CTVP00RW-9-35S\(506\)](#) [M83723/71R20416](#) [M83723/71R22196](#) [M83723/71W2039N](#) [M83723/71W24196](#) [M83723/71W2419N](#) [M83723/72A1404N-LC](#)
[M83723/72R1203N](#) [M83723/72W20418](#) [M83723/72W22126](#) [M83723/72W22556](#) [M83723/72W2419N](#) [M83723/72W2461N](#)
[M83723/73R2028N](#) [M83723/73R2039N](#) [M83723/73W1412N](#) [M83723/73W2039N](#) [M83723/74R1624N](#) [M83723/74R1808N](#)
[M83723/74R2212N](#) [M83723/74W1203N](#) [M83723/74W1412N](#) [M83723/74W20416](#) [M83723/74W2041N](#) [M83723/75R10058](#)
[M83723/75W2232N](#) [M83723/76R14157](#) [M83723/76R20256](#) [M83723/76W1808N](#) [M83723/76W2016N](#) [M83723/76W2461N](#)
[M83723/77W2016N](#) [M83723/78R22327](#) [M83723/78W2212N](#) [M83723/78W22556](#) [M85049/50-5F](#) [D38999/20FF11AC](#) [D38999/20FJ20BB](#)
[D38999/20FJ20SC](#)