

Ringlock is a range of robust circular connectors for industrial applications. It uses a metal bayonet coupling system for quick and reliable connections and thermoplastic bodies for low installed cost. The connectors are available in several sizes ranging from 4 to 48 circuits for signals of up to 13 A or coax. With the addition of a cable clamp, the connectors can be water sealed to meet IP65.



Applications:

- Industrial Electronics.
- Robotic Systems.
- Manufacturing Equipment.
- Printing Equipment.

Ringlock
Circular

Product Features

- Rugged metal coupling.
- Available in unsealed and sealed versions.
- Positive bayonet locking.
- Shell to shell keying.
- Integrally molded combined plastic body and insulator.
- Wide range of accessories.
- Accepts all Trident signal and coaxial contacts.
- PCB versions are available.
- Recognized under the component program of UL Inc. and CSA.

Performance Specifications

Operating Voltage	250 V ac rms
Contact Current Rating	Up to 13 A (For derating curve, see page 44)
Temperature Range	-55°C to 105°C (-67°F to 221°F)
Insulation Resistance	5000 MΩ at 500 V dc

Materials and Finishes

Description	Material	Finish
Insulator	Black Nylon, UL 94V-0	None
Coupling Ring	High Strength Copper Alloy	Nickel
Bayonet Pins	Stainless Steel	—
Bayonet Pins Support Band	High Strength Copper Alloy	Nickel

Contact Cavity Arrangements

Mating Face View, Standard Plug
(Mating Face View, Reversed Plug is mirror image)

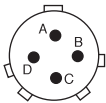

4 Way
Shell Size 10

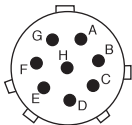

8 Way
Shell Size 12

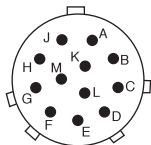

12 Way
Shell Size 14

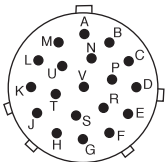

19 Way
Shell Size 16

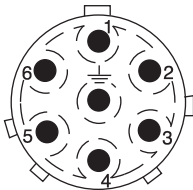

7 Way*
Shell Size 18

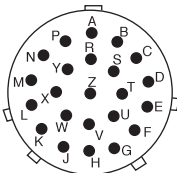

23 Way
Shell Size 18

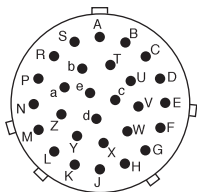

28 Way
Shell Size 20

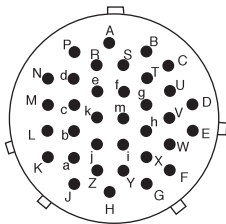

35 Way
Shell Size 22

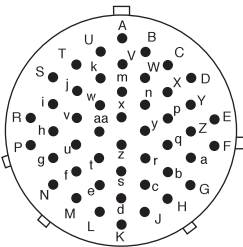

48 Way
Shell Size 24

* Meets creepage and clearance requirements for VDE 0110.

Note: The shell size indicates the diameter of the interface in sixteenths of an inch.
Example: Shell Size 16 is 1.00 inch in diameter, 25,4 mm.

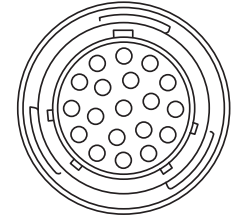
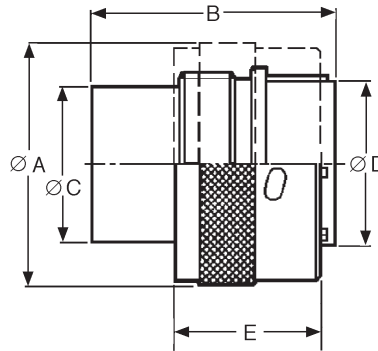

Standard Plug — Pin Contacts

- Mates with Standard Receptacles, see page 23.
- Accepts pin contacts, see page 47.
- Discriminating (Keying) Pins available, see page 52.
- Can be water sealed to IP65.

Ringlock
Circular

Number of Contacts	Shell Size	Part Number (Each)	Nomenclature	Dimensions				E	Accessory Thread
				$\varnothing A \pm 0,20 (.008)$	B max.	$\varnothing C \pm 0,15 (.005)$	$\varnothing D \pm 0,15 (.005)$		
4	10	192922-1250	TR 1004 PMS 1NB	21,60 (.850)	31,80 (1.252)	10,90 (.429)	12,20 (.480)	19,10 $\pm 0,20$ (.751 \pm .007)	9/16 - 24 UNEF
7	18	192990-1330	TR 1807 PMS 1NBE	34,30 (1.350)	33,00 (1.299)	22,50 (.885)	24,00 (.944)	19,10 $\pm 0,20$ (.751 \pm .007)	11/16 - 18 UNEF
8	12	192922-1260	TR 1208 PMS 1NB	24,80 (.976)	31,80 (1.252)	13,80 (.543)	15,10 (.594)	19,10 $\pm 0,20$ (.751 \pm .007)	11/16 - 24 UNEF
12	14	192922-1270	TR 1412 PMS 1NB	28,00 (1.102)	31,80 (1.252)	17,00 (.669)	18,30 (.720)	19,10 $\pm 0,20$ (.751 \pm .007)	13/16 - 20 UNEF
19	16	192922-1280	TR 1619 PMS 1NB	31,20 (1.228)	31,80 (1.252)	19,90 (.783)	21,40 (.842)	19,10 $\pm 0,20$ (.751 \pm .007)	15/16 - 20 UNEF
23	18	192990-1320	TR 1823 PMS 1NB	34,30 (1.350)	31,80 (1.252)	22,40 (.881)	24,00 (.944)	19,10 $\pm 0,20$ (.751 \pm .007)	11/16 - 18 UNEF
28	20	192922-1290	TR 2028 PMS 1NB	37,50 (1.476)	31,80 (1.252)	25,60 (1.007)	27,10 (1.066)	19,10 $\pm 0,20$ (.751 \pm .007)	13/16 - 20 UNEF
35	22	192922-1300	TR 2235 PMS 1NB	40,70 (1.602)	31,80 (1.252)	28,50 (1.122)	30,40 (1.196)	19,10 $\pm 0,20$ (.751 \pm .007)	15/16 - 18 UNEF
48	24	192990-1340	TR 2448 PMS 1NB	43,90 (1.728)	31,80 (1.252)	31,70 (1.248)	33,50 (1.318)	14,72 $\pm 0,15$ (.580 \pm .006)	17/16 - 18 UNEF

IMPORTANT NOTE: Standard and Reversed Format

Equipment design dictates whether the fixed connector is “live” or “dead” when disconnected. Connector housings are available that provide socket contacts on the live side of the equipment.

Standard Format: Receptacle with socket contacts.

Reversed Format: Receptacle with pin contacts.

Standard and Reversed connectors are not intermateable.



Dimensions shown in mm (inch)
Specifications and dimensions subject to change

www.ittcannon.com

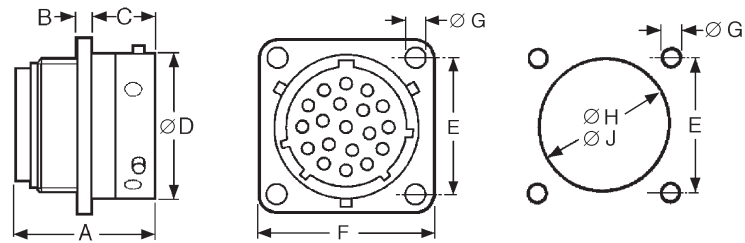

ØJ=Flange in Front of Panel
ØH= Flange at Rear of Panel

Standard Receptacle — Socket Contacts

- Mates with Standard Plugs, see page 22.
- Accepts socket contacts, see page 47.
- Printed circuit and coaxial contacts are available, see page 49.

Dimensions

Number of Contacts	Shell Size	A max.	B ± 0,15 (.005)	C ± 0,20 (.007)	ØD ± 0,15 (.005)	E ± 0,15 (.005)	F ± 0,25 (.009)	ØG ± 0,10 (.003)	ØH ± 0,10 (.003)	ØJ ± 0,10 (.003)	Accessory Thread
4	10	25,80 (1.016)	2,30 (.091)	11,15 (.439)	15,00 (.591)	18,00 (.709)	23,50 (.925)	3,25 (.128)	17,30 (.681)	15,10 (.594)	9/16 - 24 UNEF
7	18	32,50 (1.280)	2,50 (.098)	18,20 (.716)	28,50 (1.122)	27,00 (1.063)	33,30 (1.311)	3,25 (.128)	31,30 (1.232)	27,80 (1.094)	11/16 - 18 UNEF
8	12	25,80 (1.016)	2,30 (.091)	11,35 (.447)	19,00 (.748)	20,50 (.807)	26,20 (1.031)	3,25 (.128)	21,80 (.858)	18,20 (.716)	11/16 - 24 UNEF
12	14	25,80 (1.016)	2,30 (.091)	11,35 (.447)	22,20 (.874)	22,60 (.890)	28,15 (1.108)	3,25 (.128)	25,00 (.984)	21,40 (.842)	13/16 - 20 UNEF
19	16	25,80 (1.016)	2,30 (.091)	11,35 (.447)	25,40 (1.000)	24,20 (.953)	30,50 (1.200)	3,25 (.128)	28,10 (1.106)	24,60 (.968)	15/16 - 20 UNEF
23	18	25,80 (1.016)	2,50 (.098)	11,35 (.447)	28,50 (1.122)	26,90 (1.059)	33,30 (1.311)	3,25 (.128)	31,30 (1.232)	27,80 (1.094)	11/16 - 18 UNEF
28	20	33,30 (1.311)	2,50 (.098)	14,50 (.571)	31,70 (1.248)	29,20 (1.150)	36,50 (1.437)	3,25 (.128)	34,50 (1.358)	30,90 (1.216)	13/16 - 18 UNEF
35	22	33,30 (1.311)	3,50 (.138)	14,50 (.571)	34,90 (1.374)	31,60 (1.244)	39,70 (1.563)	3,25 (.128)	37,70 (1.484)	34,10 (1.342)	15/16 - 18 UNEF
48	24	33,30 (1.311)	3,50 (.138)	15,30 (.602)	38,05 (1.498)	34,45 (1.356)	42,90 (1.689)	3,90 (.154)	40,90 (1.610)	37,30 (1.468)	17/16 - 18 UNEF

Part Numbers

Number of Contacts	Shell Size	Unsealed		Sealed (see important note below)	
		Part Number (Each)	Nomenclature	Part Number (Each)	Nomenclature
4	10	192922-1190	TR 1004 RFS 1NB	192990-1660	TR 1004 RFH 1NB
7	18	192990-1300	TR 1807 RFS 1NBE	192990-1700	TR 1807 RFH 1NBE
8	12	192922-1200	TR 1208 RFS 1NB	192990-1670	TR 1208 RFH 1NB
12	14	192922-1210	TR 1412 RFS 1NB	192990-1680	TR 1412 RFH 1NB
19	16	192922-1220	TR 1619 RFS 1NB	192990-1690	TR 1619 RFH 1NB
23	18	192990-1290	TR 1823 RFS 1NB	192990-1710	TR 1823 RFH 1NB
28	20	192922-1230	TR 2028 RFS 1NB	192990-1720	TR 2028 RFH 1NB
35	22	192922-1240	TR 2235 RFS 1NB	192990-1730	TR 2235 RFH 1NB
48	24	192990-1310	TR 2448 RFS 1NB	192990-1740	TR 2448 RFH 1NB

IMPORTANT NOTE: Sealed Connectors

A sealed receptacle has an O-Ring seal that blocks moisture when the plug and receptacle are mated. However, the receptacle is not sealed in an unmated condition. For protection, dust caps are recommended for unmated receptacles, see page 24.

Plug connectors using a sealed cable clamp (see page 25) with jacketed cable will meet IP65 when mated to a sealed receptacle

Dimensions shown in mm (inch)

Specifications and dimensions subject to change

www.ittcannon.com



Ringlock Circular

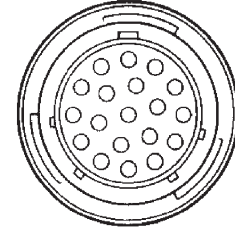
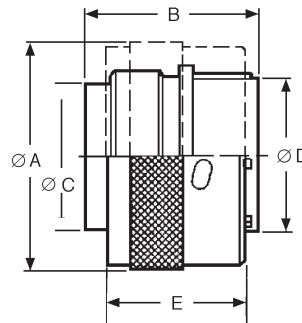

Reversed Plug — Socket Contacts

- Mates with Reversed Receptacles, see page 25.
- Accepts socket contacts, see page 47.
- Discriminating (Keying) Pins available, see page 52.
- Can be water sealed to IP65.

Ringlock
Circular

Number of Contacts	Shell Size	Part Number (Each)	Nomenclature	Dimensions				E	Accessory Thread
				ØA ± 0,20 (.008)	B max.	ØC ± 0,15 (.005)	ØD ± 0,15 (.005)		
4	10	192926-0500	TR 1004 PFS 1NB	21,60 (.850)	26,10 (1.027)	11,00 (.433)	12,20 (.480)	19,10 ±0,20 (.751 ±.007)	9/16 - 24 UNEF
7	18	192990-1390	TR 1807 PFS 1NBE	34,30 (1.350)	31,50 (1.240)	22,50 (.885)	24,00 (.944)	19,10 ±0,20 (.751 ±.007)	1-1/16 - 18 UNEF
8	12	192926-0510	TR 1208 PFS 1NB	24,80 (.976)	25,60 (1.008)	13,90 (.547)	15,10 (.594)	19,10 ±0,20 (.751 ±.007)	11/16 - 24 UNEF
12	14	192926-0520	TR 1412 PFS 1NB	28,00 (1.102)	26,80 (1.055)	17,10 (.673)	18,30 (.720)	19,10 ±0,20 (.751 ±.007)	13/16 - 20 UNEF
19	16	192926-0530	TR 1619 PFS 1NB	31,20 (1.228)	27,60 (1.087)	20,00 (.787)	21,40 (.842)	19,10 ±0,20 (.751 ±.007)	15/16 - 20 UNEF
23	18	192990-1380	TR 1823 PFS 1NB	34,30 (1.350)	25,60 (1.088)	22,50 (.885)	24,00 (.944)	19,10 ±0,20 (.751 ±.007)	1-1/16 - 18 UNEF
28	20	192926-0540	TR 2028 PFS 1NB	37,50 (1.476)	31,30 (1.232)	25,70 (1.011)	27,10 (1.066)	19,10 ±0,20 (.751 ±.007)	1-3/16 - 20 UNEF
35	22	192926-0550	TR 2235 PFS 1NB	40,70 (1.602)	31,30 (1.232)	28,60 (1.126)	30,40 (1.196)	19,10 ±0,20 (.751 ±.007)	1-5/16 - 18 UNEF
48	24	192990-1400	TR 2448 PFS 1NB	43,90 (1.728)	31,30 (1.232)	31,80 (1.225)	33,50 (1.318)	14,72 ±0,15 (.580 ±.006)	1-7/16 - 18 UNEF

IMPORTANT NOTE: Standard and Reversed Format
 Equipment design dictates whether the fixed connector is "live" or "dead" when disconnected. Connector housings are available that provide socket contacts on the live side of the equipment.

Standard Format: Receptacle with socket contacts.
 Reversed Format: Receptacle with pin contacts.

Standard and Reversed connectors are not intermateable.



Dimensions shown in mm (inch)
 Specifications and dimensions subject to change

www.ittcannon.com

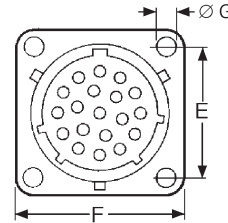
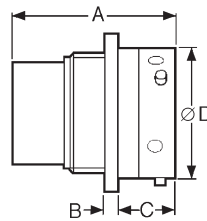

Panel Cutout

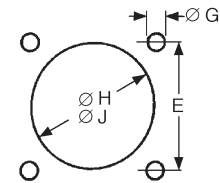

ØJ = Flange in Front of Panel
ØH = Flange at Rear of Panel

Reversed Receptacle — Pin Contacts

- Mates with Reversed Plugs, see page 24.
- Accepts pin contacts, see page 47.
- Printed Circuit and coaxial contacts are available, see page 47.

Dimensions

Number of Contacts	Shell Size	A max.	B ±0,15 (.005)	C ±0,20 (.007)	ØD ±0,15 (.005)	E ±0,15 (.005)	F ±0,25 (.009)	ØG ±0,10 (.003)	ØH ±0,10 (.003)	ØJ ±0,10 (.003)	Accessory Thread
4	10	31,50 (1.240)	2,30 (.091)	11,35 (.447)	15,00 (.591)	18,00 (.709)	23,50 (.925)	3,25 (.128)	17,30 (.681)	15,10 (.594)	9/16 - 24 UNEF
7	18	34,20 (1.346)	2,30 (.091)	17,80 (.700)	28,50 (1.122)	27,00 (1.063)	33,30 (1.311)	3,25 (.128)	31,30 (1.232)	27,80 (1.094)	1-1/16 - 18 UNEF
8	12	31,50 (1.240)	2,30 (.091)	11,35 (.447)	19,00 (.748)	20,50 (.807)	26,20 (1.031)	3,25 (.128)	21,80 (.858)	18,20 (.716)	11/16 - 24 UNEF
12	14	31,50 (1.240)	2,30 (.091)	11,35 (.447)	22,20 (.874)	22,60 (.890)	28,15 (1.108)	3,25 (.128)	25,00 (.984)	21,40 (.842)	13/16 - 20 UNEF
19	16	31,50 (1.240)	2,30 (.091)	11,35 (.447)	25,40 (1.000)	24,20 (.953)	30,50 (1.200)	3,25 (.128)	28,10 (1.106)	24,60 (.968)	15/16 - 20 UNEF
23	18	31,50 (1.240)	2,50 (.098)	11,35 (.447)	28,50 (1.122)	26,90 (1.059)	33,30 (1.311)	3,25 (.128)	31,30 (1.232)	27,80 (1.094)	1-1/16 - 18 UNEF
28	20	33,00 (1.299)	2,50 (.098)	14,55 (.573)	31,70 (1.248)	29,20 (1.150)	36,50 (1.437)	3,25 (.128)	34,50 (1.358)	30,90 (1.216)	1-3/16 - 18 UNEF
35	22	33,00 (1.299)	3,50 (.138)	14,55 (.573)	34,90 (1.374)	31,60 (1.244)	39,70 (1.563)	3,25 (.128)	37,70 (1.484)	34,10 (1.342)	1-5/16 - 18 UNEF
48	24	34,80 (1.370)	3,50 (.138)	15,35 (.604)	38,05 (1.498)	34,45 (1.356)	42,90 (1.689)	3,90 (.154)	40,90 (1.610)	37,30 (1.468)	1-7/16 - 18 UNEF

Part Numbers

Number of Contacts	Shell Size	Unsealed		Sealed (see important note below)	
		Part Number (Each)	Nomenclature	Part Number (Each)	Nomenclature
4	10	192926-0440	TR 1004 RMS 1NB	192990-1760	TR 1004 RMH 1NB
7	18	192990-1360	TR 1807 RMS 1NBE	192990-1800	TR 1807 RMH 1NBE
8	12	192926-0450	TR 1208 RMS 1NB	192990-1770	TR 1208 RMH 1NB
12	14	192926-0460	TR 1412 RMS 1NB	192990-1780	TR 1412 RMH 1NB
19	16	192926-0470	TR 1619 RMS 1NB	192990-1790	TR 1619 RMH 1NB
23	18	192990-1350	TR 1823 RMS 1NB	192990-1810	TR 1823 RMH 1NB
28	20	192926-0480	TR 2028 RMS 1NB	192990-1820	TR 2028 RMH 1NB
35	22	192926-0490	TR 2235 RMS 1NB	192990-1830	TR 2235 RMH 1NB
48	24	192990-1370	TR 2448 RMS 1NB	192990-1840	TR 2448 RMH 1NB

IMPORTANT NOTE: Sealed Connectors

A sealed receptacle has an O-Ring seal that blocks moisture when the plug and receptacle are mated. However, the receptacle is not sealed in an unmated condition. For protection, dust caps are recommended for unmated receptacles, see page 24.

Plug connectors using a sealed cable clamp (see page 25) with jacketed cable will meet IP65 when mated to a sealed receptacle.

Dimensions shown in mm (inch)

Specifications and dimensions subject to change

www.ittcannon.com



Ringlock Circular

Cannon Trident Connector System

Ringlock Circular Connectors

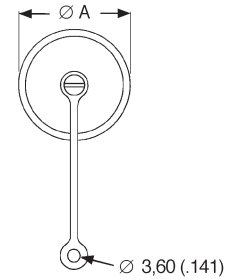
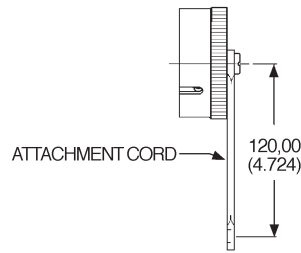

Plastic Dust Caps for Receptacles

- Protects unmated receptacles.
- Durable construction for long-term use.
- For use with Ringlock receptacles.

Shell Size	Part Number (Each)	Part Number (Pack of 100)	Dimension Ø A max.
10	192900-0666	192900-0676	21,80 (.858)
12	192900-0667	192900-0677	25,40 (1.000)
14	192900-0668	192900-0678	28,60 (1.126)
16	192900-0669	192900-0679	31,70 (1.248)
18	192900-0670	192900-0680	34,90 (1.374)
20	192900-0671	192900-0381	38,10 (1.500)
22	192900-0672	192900-0682	41,20 (1.622)
24	192900-0673	192900-0683	44,40 (1.748)

Ringlock
Circular

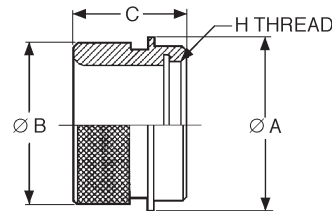

Adapters for Heat Shrink Boots or Sleeving

Shell Size	Part Number (Each)	Nomenclature	ØA max.	ØB max.	C max.	H Thread
10	192990-1430	TR 10 AAD	21,00 (.827)	18,10 (.712)	19,20 (.755)	9/16 - 24 UNEF-2B
12	192990-1440	TR 12 AAD	24,00 (.944)	23,40 (.921)	19,20 (.755)	11/16 - 24 UNEF-2B
14	192990-1450	TR 14 AAD	27,00 (1.063)	24,20 (.952)	19,20 (.755)	13/16 - 20 UNEF-2B
16	192990-1460	TR 16 AAD	30,20 (1.189)	29,60 (1.165)	21,50 (.846)	15/16 - 20 UNEF-2B
18	192990-1470	TR 18 AAD	33,30 (1.311)	31,70 (1.248)	21,50 (.846)	11/16 - 18 UNEF-2B
20	192990-1480	TR 20 AAD	36,50 (1.437)	35,80 (1.409)	22,80 (.897)	13/16 - 18 UNEF-2B
22	192990-1490	TR 22 AAD	39,70 (1.563)	38,20 (1.503)	22,80 (.897)	15/16 - 18 UNEF-2B
24	192990-1500	TR 24 AAD	42,90 (1.689)	41,30 (1.626)	21,90 (.862)	17/16 - 18 UNEF-2B



Panel Gaskets For Ringlock Receptacle Connectors

- All panel gaskets are 1,50 (.059) thick.

Shell Size	Part Number (Pack of 100)
10	075-8543-011
12	075-8543-012
14	192900-0565
16	192900-0566
18	075-8543-015
20	192991-0566
22	075-8543-017
24	192900-0567



Dimensions shown in mm (inch)
Specifications and dimensions subject to change

www.ittcannon.com



Sealed Cable Clamps for Use With Ringlock Circular Connectors

- For use with jacketed cables.
- Provides strain relief and wire protection.
- Can be water sealed to IP65. See notes on pages 22 and 24.
- For assembly instructions, see page 56.

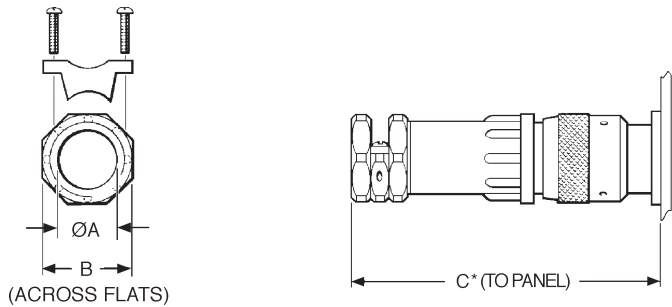

* For disassembly, add 9,00 (.354) for Shell Sizes 10-16 & add 10,60 (.417) for Shell Sizes 18-24.

Shell Size	Part Number (Each)	Nomenclature	Dimensions		
			Ø A max.	B ± 0,20 (.007)	C* max.
10	192990-1530	TR 10 AHC 1N	11,10 (.437)	18,80 (.740)	76,50 (3.011)
12	192990-1540	TR 12 AHC 1N	13,60 (.535)	20,80 (.818)	77,80 (3.063)
14	192990-1550	TR 14 AHC 1N	14,60 (.574)	22,80 (.897)	85,50 (3.366)
16	192990-1560	TR 16 AHC 1N	16,60 (.653)	24,70 (.972)	89,80 (3.535)
18	192990-1570	TR 18 AHC 1N	16,60 (.653)	24,70 (.972)	93,00 (3.661)
20	192990-1580	TR 20 AHC 1N	22,10 (.870)	31,80 (1.252)	107,50 (4.232)
22	192990-1590	TR 22 AHC 1N	22,10 (.870)	31,80 (1.252)	114,50 (4.507)
24	192990-1600	TR 24 AHC 1N	29,60 (1.165)	41,80 (1.645)	128,50 (5.059)

* Assumes a uniformly cylindrical cable. Variations in the diameter could effect sealing.

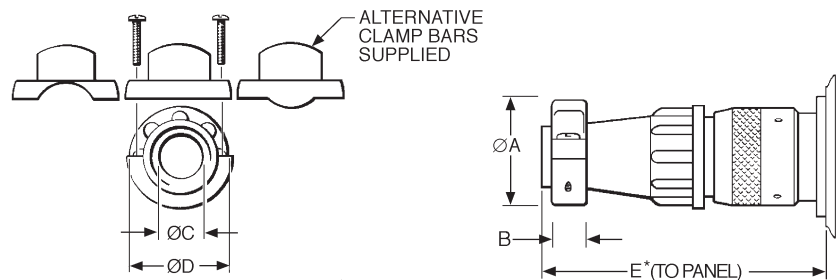

* For disassembly, add 9,00 (.354) for Shell Sizes 10-16 & add 10,60 (.417) for Shell Sizes 18-24.

Unsealed Cable Clamps For Use With Ringlock Circular Connectors

- Provides strain relief and wire protection.
- For assembly instructions, see page 59.

Shell Size	Part Number (Each)	Nomenclature	Dimensions				
			Ø A max.	B ± 0,15 (.005)	Ø C max.	Ø D ± 0,15 (.005)	E* max.
10	192922-1310	TR 10 ASR 1N	21,50 (.846)	6,40 (.251)	8,70 (.342)	21,00 (.826)	61,30 (2.413)
12	192922-1320	TR 12 ASR 1N	24,90 (.980)	6,40 (.251)	12,80 (.503)	24,00 (.944)	61,30 (2.413)
14	192922-1330	TR 14 ASR 1N	27,00 (1.063)	6,40 (.251)	13,80 (.543)	27,00 (1.063)	67,10 (2.641)
16	192922-1340	TR 16 ASR 1N	30,10 (1.185)	6,40 (.251)	17,00 (.669)	30,20 (1.189)	67,10 (2.641)
18	192990-1510	TR 18 ASR 1N	32,00 (1.259)	7,00 (.275)	19,90 (.783)	33,20 (1.307)	70,80 (2.787)
20	192922-1350	TR 20 ASR 1N	34,30 (1.350)	7,00 (.275)	21,00 (.827)	36,40 (1.433)	79,30 (3.122)
22	192922-1360	TR 22 ASR 1N	37,10 (1.460)	8,20 (.322)	23,00 (.905)	39,60 (1.559)	85,30 (3.358)
24	192990-1520	TR 24 ASR 1N	41,80 (1.645)	8,20 (.322)	27,00 (1.063)	42,80 (1.685)	90,80 (3.574)

Dimensions shown in mm (inch)
Specifications and dimensions subject to change

www.ittcannon.com



Ringlock Circular

X-ON Electronics

Largest Supplier of Electrical and Electronic Components

Click to view similar products for [Circular DIN Connectors](#) category:

Click to view products by [ITT](#) manufacturer:

Other Similar products are found below :

[CTV06RQF-25-8SA-LC](#) [CTV06RQF-25-8S-LC](#) [CTV06RQW-25-8SB-LC](#) [CTV06RW-25-20P](#) [CTV06RW-25-20PA](#) [CTV06RW-25-20PB](#)
[CTV06RW-25-20PE-LC](#) [CTV06RW-25-20SB](#) [CTV06RW-25-20SE](#) [CTV07RW-17-8S\(506\)](#) [CTVP00RW-19-32S\(506\)](#) [CTVP00RW-9-35S\(506\)](#) [M83723/71R20416](#) [M83723/71R22196](#) [M83723/71W2039N](#) [M83723/71W24196](#) [M83723/71W2419N](#) [M83723/72A1404N-LC](#)
[M83723/72R1203N](#) [M83723/72W20418](#) [M83723/72W22126](#) [M83723/72W22556](#) [M83723/72W2419N](#) [M83723/72W2461N](#)
[M83723/73R2028N](#) [M83723/73R2039N](#) [M83723/73W1412N](#) [M83723/73W2039N](#) [M83723/74R1624N](#) [M83723/74R1808N](#)
[M83723/74R2212N](#) [M83723/74W1203N](#) [M83723/74W1412N](#) [M83723/74W20416](#) [M83723/74W2041N](#) [M83723/75R10058](#)
[M83723/75W2232N](#) [M83723/76R14157](#) [M83723/76R20256](#) [M83723/76W1808N](#) [M83723/76W2016N](#) [M83723/76W2461N](#)
[M83723/77W2016N](#) [M83723/78R22327](#) [M83723/78W2212N](#) [M83723/78W22556](#) [M85049/50-5F](#) [D38999/20FF11AC](#) [D38999/20FJ20BB](#)
[D38999/20FJ20SC](#)