

ACTUATOR OPTIONS

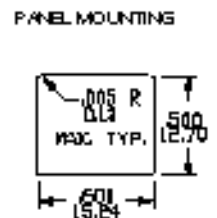

TERMINATION OPTIONS

M1 STD

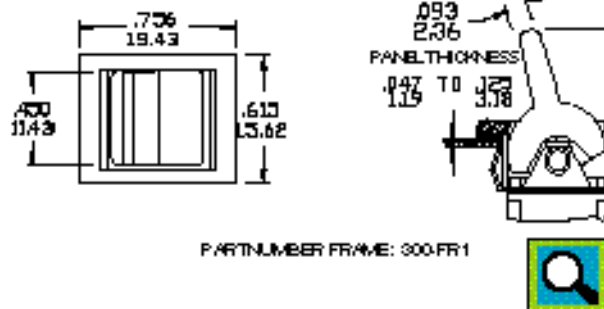
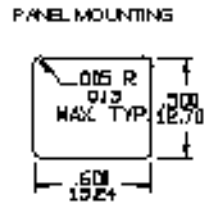
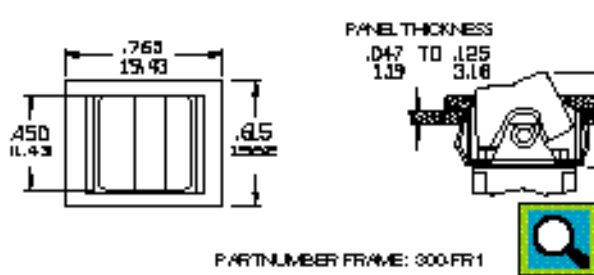
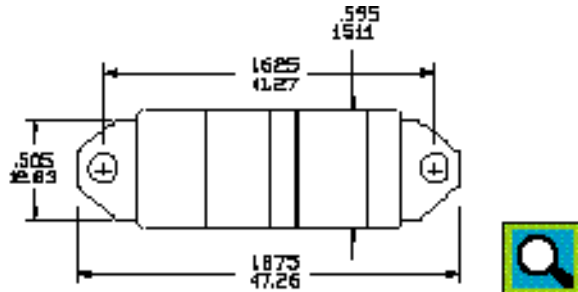
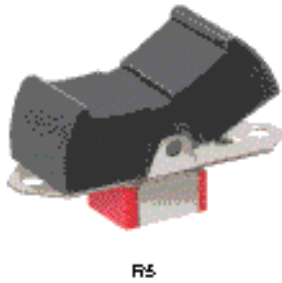
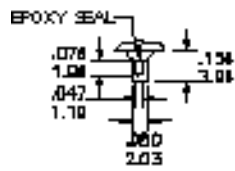

THK .080 (0.78)

M2

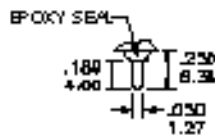

THK .030 (0.76)

M3 (QUICK CONNECT)



THK .030 (0.76)

M5

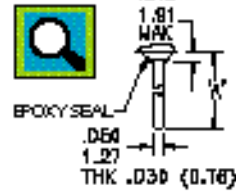

OPTION CODE	DLX*
M5-1	.750(19.05)
M5-2	.964(24.48)
M5-3	.425(10.80)
M5-4	1.052(26.97)

ROCKER, PADDLE AND FRAME COLORS

NO.	COLOR
1	WHITE
2	BLACK(STD)
3	RED

For other colors please consult factory

X-ON Electronics

Largest Supplier of Electrical and Electronic Components

Click to view similar products for [Rocker Switches](#) category:

Click to view products by [IC Switches](#) manufacturer:

Other Similar products are found below :

[VKD2GHNB-00000-000](#) [VSD2GNNB-00000-000](#) [6-1571986-5](#) [6-1571986-9](#) [632422-4B-KD](#) [7036WWCDBX653+U622](#) [8055K52Z7V](#)
[8138K20E6M50](#) [FMC18A2200002](#) [84206L](#) [84312LX](#) [PREDD4-07F-BB0FW](#) [PREDD5-07F-BB0GW](#) [PRFDD1-16F-BB000](#) [PRFDD3-16F-](#)
[BB000](#) [1-1634201-0](#) [999-16702-001](#) [A101J2ZQ004](#) [A101J4ZQ004](#) [A101J51CB0004](#) [A107J51ZQ0004](#) [A201J1AQ004](#) [A201J1AV2Q004](#)
[A201J3ZB004](#) [A201J50ZQ004](#) [A203J51ZQ0004](#) [A226L11YZQ](#) [A22L11A](#) [A435S1YZQ](#) [H8500XBBBBL-A](#) [H8653VBBG2577W](#)
[HB130CHNWWNAAC](#) [1251.0303](#) [AE205J60V3B004](#) [RH110C2NBB](#) [1352.0107](#) [1363.0201](#) [AML25GBF2AA03GR](#) [1571099-3](#) [1571987-4](#)
[1571987-5](#) [1571989-7](#) [B123J77V7B2](#) [B226J50W4Q22P](#) [B433J37ZQ22M](#) [160212E](#) [1801.1164](#) [1831.1102](#) [1833.3402](#) [1837.1118](#)