



## **iCE40 Ultra Wearable Development Platform User Guide**

---

EB100 Version 1.0, July 2015

## Introduction

The iCE40 Ultra Wearable Development Platform is an easy-to-use platform which demonstrates how the iCE40 Ultra and MachXO2 FPGAs can be utilized in wearable and mobile applications. Along with the evaluation board and accessories, there are reference designs available to demonstrate the functionality of the boards and components.

The iCE40 Ultra Wearable Development Platform consists of two boards: the Main Board and the Sensor Board. The Main Board contains the iCE40 Ultra and MachXO2 FPGAs, which drive various components on the board. The iCE40 Ultra focuses on interfacing with peripheral components such as LEDs, sensors and BLE connectivity. The MachXO2 focuses on driving the MIPI DSI Display from a Quad SPI flash functioning as a frame buffer and storage device. The Sensor Board contains several sensors that are typically found in mobile and wearable devices. By separating the two boards, the interconnect headers can be used to directly interface with peripherals for testing (see the [Headers](#) section).

The contents of this user guide include a description of the board features, header connection descriptions and pinouts, instructions on loading demonstration bitstreams, a complete set of schematics, and the bill of materials.

## Features

The iCE40 Ultra Wearable Development Platform includes:

- iCE40 Ultra Wearable Development Platform Main Board:
  - iCE40 Ultra (iCE5LP-4K-SWG36) device in a 36-ball WLCSP package
  - MachXO2 (LCMXO2-2000ZE-1UWG49) device in a 49-ball WLCSP package
  - High-current IR, White, and RGB LEDs
  - Stereo Microphones
  - Connector and driver circuitry for MIPI DSI Display
  - Headers for I2C, SPI, and UART
  - Mini-USB programming connection
  - Battery charger
  - RoHS-compliant packaging and process
- iCE40 Ultra Wearable Development Platform Sensor Board:
  - Bluetooth Low-Energy Module
  - Heart-rate/SpO2 Sensor and Analog Front End
  - Skin temperature sensor
  - Pressure sensor
  - Accelerometer/Gyroscope
  - Pads for soldering on battery (charger accepts Li-Ion and Li-Po)
- Syma 652030 Battery – 3.7 V, 250 mAh Lithium-Polymer Battery provides power while the USB cable is disconnected
- LG LH154Q01 Display – 240x240 Single Lane MIPI DSI Display. Must be attached prior to power-up
- USB Connector Cable – A mini-USB port provides power and a programming interface for the board
- Watch Strap – A watch strap comes pre-attached to the Sensor Board

*Note: Static electricity can severely shorten the lifespan of electrical components. Use care while handling the iCE40 Ultra Wearable Development Platform to avoid ESD damage.*

Figure 1 through Figure 4 show the top and bottom sides of the Main and Sensor boards, with key features highlighted.

**Figure 1. Main Board (Top Side)**

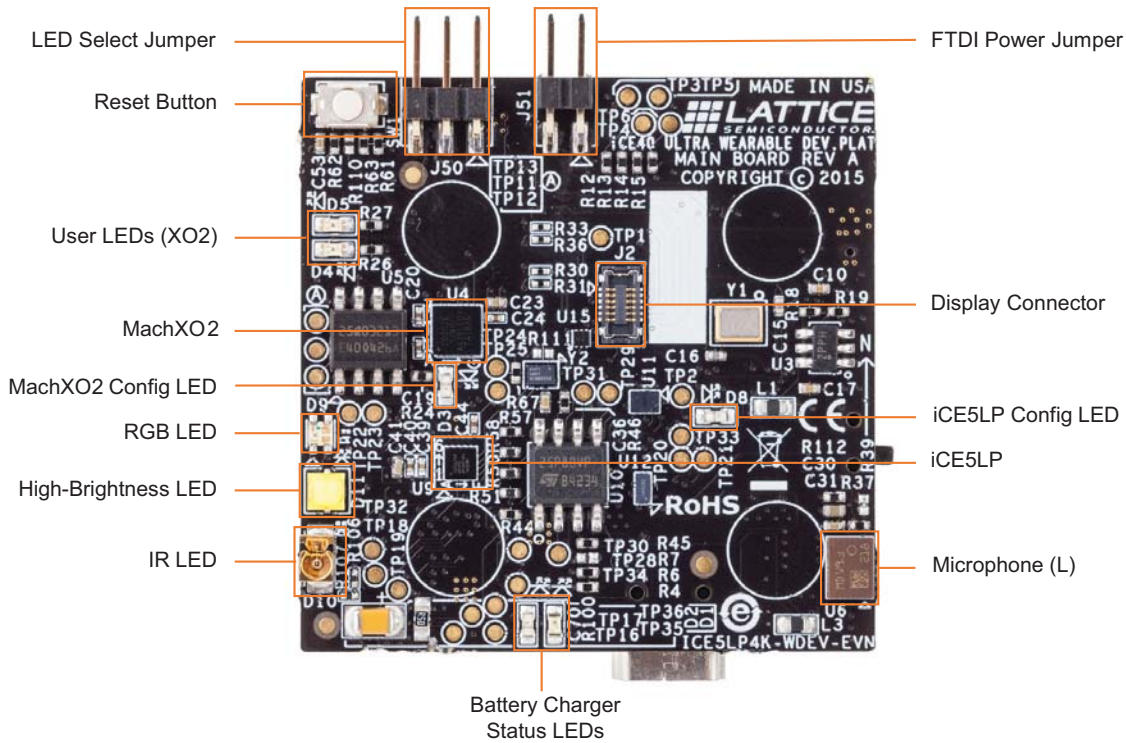

**Figure 2. Main Board (Bottom Side)**

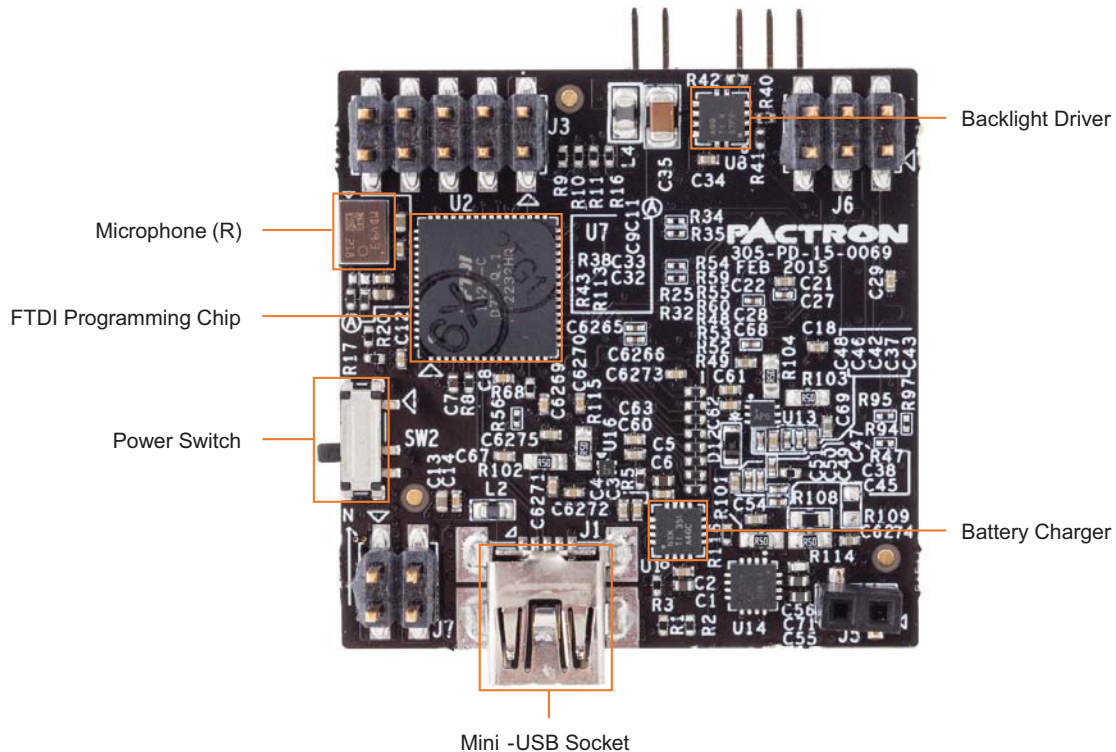

Figure 3. Sensor Board (Top Side)

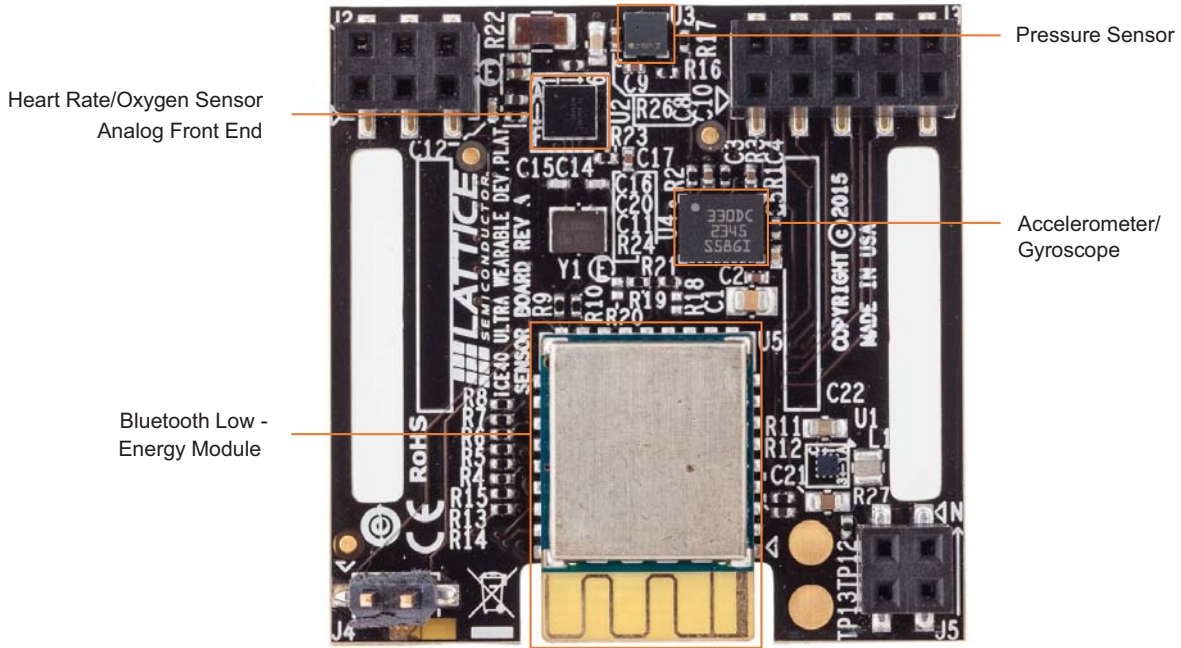
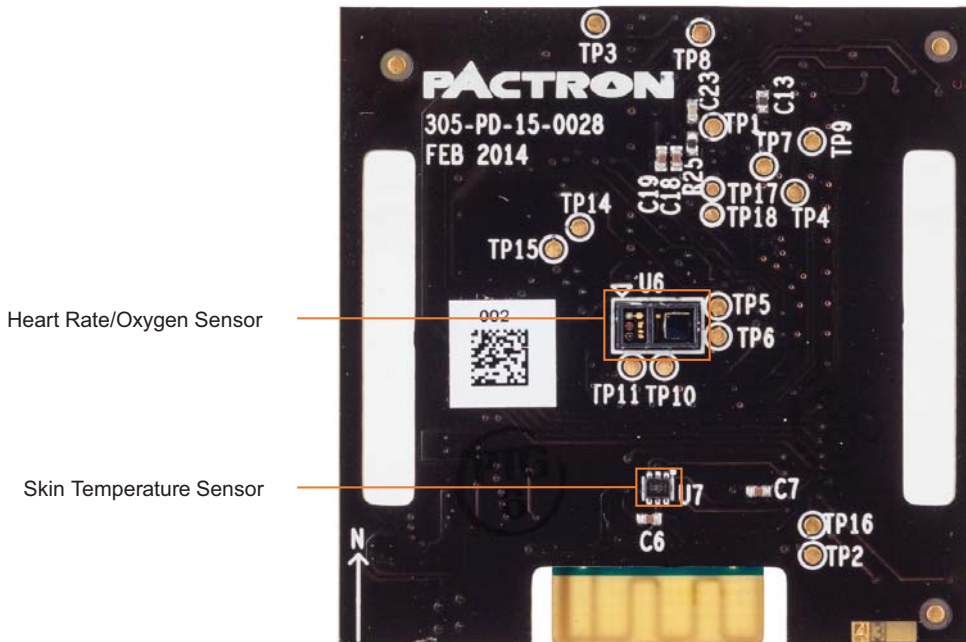

Figure 4. Sensor Board (Bottom Side)



## Lattice Semiconductor Devices

The Main Board features an iCE5LP4K and a MachXO2-2000ZE FPGA.

The iCE5LP4K has a 1.2 V core supply and is packaged in a 36-ball WLCSP package. For a complete description of this device, see DS1048, [iCE40 Ultra Family Data Sheet](#).

The MachXO2-2000ZE has a 1.2 V core supply and is packaged in a 49-ball WLCSP package. For a complete description of this device, see DS1035, [MachXO2 Family Data Sheet](#).

## Software Requirements

The following software must be installed before designs can be developed for this board:

- iCEcube2 2014-12 (or higher)
- Diamond® 3.4 (or higher)
- Diamond Programmer 3.4 (or higher)

This software is available at the Lattice website [Design Software & IP](#) page.

## Board Power

The iCE40 Ultra Wearable Development Platform uses the USB connection as its primary source of power. It is also equipped with a battery and charger for use without a wired connection. A power switch (SW2) allows for the regulators to be disabled while allowing the battery to continue charging. Two status LEDs allow the battery charger to be monitored (see Table 12).

The battery charger and regulators are located on the Main Board. The battery attaches to the Sensor Board. Power is transferred between the two boards using the Power Connector header. See Table 2 for connections.

The VREG\_ADJ I/O supply net for the iCE5LP is adjustable, but is an internal, reserved feature. Changing this net from 3.3 V (default) to 1.8 V will cause voltage-level mismatches that can permanently damage the iCE5LP.

To allow current measurements to be made for specific supplies, resistors with test points have been inserted into the circuit. Refer to Table 1 to see which test points correspond to which supplies.

**Table 1. Supply Current Test Points**

Supply	TP+	TP-	Resistance
MachXO2 1.2 V	TP20	TP21	0.5 Ohms
MachXO2 3.3 V	TP18	TP19	0.5 Ohms
iCE5LP 1.2 V	TP20	TP33	0.5 Ohms
iCE5LP 3.3 V	TP18	TP32	0.5 Ohms
3.3 V Regulator	TP16	TP17	0.5 Ohms
Display 3 V	TP25	TP24	0.5 Ohms
Display 1.8 V	TP22	TP23	0.5 Ohms



## Headers

Four headers are used to connect the Main Board and the Sensor Board. The signals and connections are shown in the tables below:

**Figure 5. Headers**

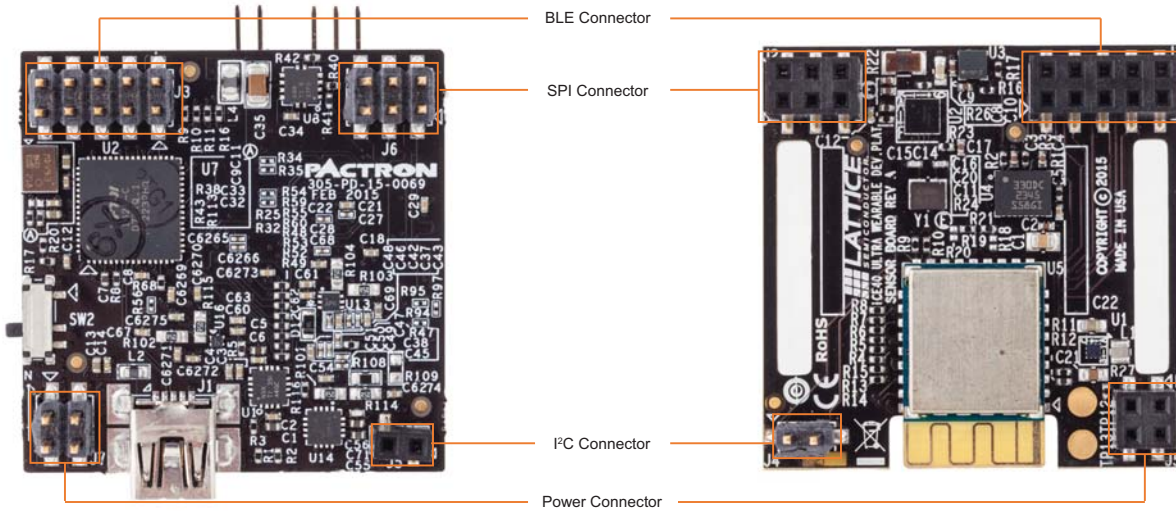

**Power Connector** (Main Board J7, Sensor Board J5): Power connection between the two boards

**Table 2. Power Connector**

Pin Number	Signal	Description
1	3V3	Regulated 3.3 V supply
2	BT_3V7	Unregulated ~3.7 V battery voltage
3	VREG_ADJ	Adjustable I/O Voltage (3.3 V default)
4	GND	Ground

**I2C Connector** (Main Board J5, Sensor Board): Interface for pressure sensor, temperature sensor, and accelerometer/gyroscope

**Table 3. I2C Connector**

Pin Number	Signal	iCE5LP Ball #
1	Sensor SCL	C1
2	Sensor SDA	E2

**SPI Connector** (Main Board J6, Sensor Board): Interface for the Analog Front-End of the Heart Beat/SpO2 sensor

**Table 4. SPI Connector**

Pin Number	Signal	iCE5LP Ball #
1	AFE SCLK	D6
2	AFE MISO	F6
3	AFE Ready	B5
4	AFE SS	D5
5	AFE MOSI	E6
6	GND	—

**BLE Connector** (Main Board J3, Sensor Board): Contains a UART connection to iCE5LP and a configuration SPI connection for the iCE5LP

**Table 5. BLE Connector**

Pin Number	Signal	Ball #
1	BLE Prog	MachXO2 G2
2	BLE SS	Config
3	BLE MISO	Config
4	BLE MOSI	Config
5	BLE SCLK	Config
6	CRSTb	—
7	CDONE	MachXO2 E3
8	UART Rx (out)	iCE5LP F5
9	UART Tx (in)	iCE5LP E5
10	GND	—

## Jumpers

The following jumpers can be used for adjusting board functionality:

- High-current LED select (J50): Controls whether the IR LED (1+2) or High-current White LED (2+3) is driven by the iCE5LP device
- FTDI Power (J51): To minimize power consumption and increase battery life, the FTDI programming chip can have its power supply cut-off by removing the jumper from J51. J51 must be in place prior to powering up in order to program the devices on this board.

## Test Points

Several test points have been included into the design to ease debug. Descriptions of these test points can be found below:

**Table 6. Main Board Test Points**

Test Point	Signal/Function
1	Configuration Signal: CResetn_FTDI
2	Configuration Signal: iCE_CDONE
3	Configuration Signal: FTDI_TCK (XO2)
4	Configuration Signal: FTDI_TDI (XO2)
5	Configuration Signal: FTDI_TDO (XO2)
6	Configuration Signal: FTDI_TMS (XO2)
11	Configuration Signal: JTAGEN (XO2)
12	Configuration Signal: PROGRAMN (XO2)
13	Configuration Signal: INITN (XO2)
16	Current Measurement (See Table 1)
17	Current Measurement (See Table 1)
18	Current Measurement (See Table 1)
19	Current Measurement (See Table 1)
20	Current Measurement (See Table 1)
21	Current Measurement (See Table 1)
22	Current Measurement (See Table 1)
23	Current Measurement (See Table 1)
24	Current Measurement (See Table 1)
25	Current Measurement (See Table 1)
28	Configuration Signal: FLASH_MISO (iCE)
29	Configuration Signal: FLASH_MOSI (iCE)
30	Configuration Signal: FLASH_CSB (iCE)
31	Configuration Signal: FLASH_SCLK (iCE)
32	Current Measurement (See Table 1)
33	Current Measurement (See Table 1)
34	3.3 V Regulator Output Control (See TPS7A7200)
35	3.3 V Regulator Output Control (See TPS7A7200)
36	3.3 V Regulator Output Control (See TPS7A7200)



**Table 7. Sensor Board Testpoints**

Test Point	Signal/Function
1	AFE4403: CLKOUT
2	BLE Config: SWCLK
3	LPS25H: INT1
4	AFE4403: TX3
5	AFE4403: INN
6	AFE4403: INP
7	AFE4403: ADC_RDY
8	AFE4403: LED_DRV_SUP
9	AFE4403: VCM
10	AFE4403: TXP
11	AFE4403: TXN
12	Battery Connector (+)
13	Battery Connector (-)
14	LSM330DLC: INT1_G
15	LSM330DLC: INT2_G
16	BLE Config: SWDIO
17	AFE4403: Manual Reset, short to TP18
18	AFE4403: Manual Reset, short to TP17

### Device Interconnects

Six general purpose connections have been made between Lattice MachXO2 and iCE5LP devices for communication between FPGAs. Level translators have been implemented on these lines, which limit their operation frequency. Table 8 lists connection ports and maximum operation frequencies:

**Table 8. MachXO2 and iCE5LP Interconnections**

Net Number	MachXO2 Ball	iCE5LP Ball	Max Frequency
1	E6	C2	20 MHz
2	E5	B1	20 MHz
3	D5	D2	100 MHz
4	D4	B2	100 MHz
5	G4	B4	100 MHz
6	F4	F4	100 MHz

## Display

The iCE40 Ultra Wearable Development Platform includes an LG LH154Q01 Display and necessary driving circuitry. MIPI DSI clock and data signals are driven by the Lattice MachXO2 device, through a resistor network for achieving proper voltage levels. This display also provides a frame-sync signal, B\_Sync, which is routed to a MachXO2 pin. Display supplies and the backlight driver are controlled by outputs from the MachXO2.

**Table 9. Display Signals**

Signal	MachXO2 Ball	I/O Type
Clock HS+	C4	LVDS25
Clock HS-	D3 (Auto)	LVDS25 (Auto)
Clock LP+	C7	LVC MOS12
Clock LP-	C6	LVC MOS12
Data HS+	C1	LVDS25
Data HS-	D2 (Auto)	LVDS25 (Auto)
Data LP+	A7	LVC MOS12
Data LP-	B6	LVC MOS12
Reset	B2	LVC MOS33
B_Sync	A3	LVC MOS33
Backlight PWM	C3	LVC MOS33
3 V Enable	C2	LVC MOS33
1.8 V Enable	E2	LVC MOS33

*Note: For the high-speed differential signals (Clock HS, Data HS) only the positive channel must be assigned, the negative channel will be automatically placed.*

## Clock Sources

The Main Board has a single 27 MHz clock source that connects to the Lattice MachXO2 device. To use this external clock with the iCE5LP device, the 27 MHz clock can be routed from the MachXO2 via one of the six general purpose interconnects. These connections can be found in Table 8.

**Table 10. Clock Sources**

Source	Frequency	XO2 Ball	iCE Ball
Oscillator	27 MHz	E4	—

## Reset Button

A button (SW1) is included for performing resets of systems on board the iCE40 Ultra Wearable Development Platform. By default, this button will perform a configuration reset of the iCE5LP, MachXO2, and the Bluetooth module.

**Table 11. Reset Resistors and Pins**

Device	Resistor	FPGA Ball
MachXO2	R110	B3
iCE5LP	R62	—
Seed BLE	R63	—

*Note: If VREG\_ADJ (see the [Board Power](#) section) is changed, these resistors must be removed to prevent voltage level mismatches.*

## LEDs

The Main Board has four system status LEDs, two user LEDs, an RGB LED, an IR LED, and a High-current White LED.

The iCE40 Ultra has I/O ports specially built for sinking current from high-power LEDs. The RGB LED ports (A6, B6, and C6) are able to sink 24 mA each, while the high-current LED port (A2) is able to sink up to 500 mA.

Please note that the IR LED is only rated for 100 mA and can be damaged by incorrectly configuring the port in custom designs. This is not a problem for the RGB LED and High-current White LED, since they are rated for more current than the ports can sink.

The LED functions and FPGA connections are detailed below:

**Table 12. Main Board LEDs**

LED Number	MachXO2 Ball	iCE40 Ball	Function
D1	—	—	Power Source Connected
D2	—	—	Battery Charging
D3	Config	—	MachXO2 CDONE
D4	E7	—	User LED
D5	F7	—	User LED
D8	—	Config	iCE40 CDONE
D9 (R)	—	C6	RGB LED (Red)
D9 (G)	—	B6	RGB LED (Green)
D9 (B)	—	A6	RGB LED (Blue)
D10	—	A2*	IR LED (see the <a href="#">Jumpers</a> section)
D11	—	A2*	High-current White LED (see the <a href="#">Jumpers</a> section)

## Sensors and Peripherals

The iCE40 Ultra Wearable Development Platform utilizes several third-party devices. Links for more information can be found below:

**Table 13. Main Board Sensors and Peripherals**

Name	Reference Number	Interface	FPGA Connections	Part Number	Link
Microphone	U6, U7	I2S	iCE5LP: Clock (F3), Data (E3)	MP34DB01	<a href="http://www.st.com/web/en/catalog/sense_power/FM125/SC1564/PF250941">http://www.st.com/web/en/catalog/sense_power/FM125/SC1564/PF250941</a>

**Table 14. Sensor Board Sensors and Peripherals**

Name	Reference Number	Interface	FPGA Connections	Part Number	Link
Temperature Sensor	U7	I2C	See Table 3	TMP112	<a href="http://www.ti.com/product/tmp112">http://www.ti.com/product/tmp112</a>
Pressure Sensor	U3	I2C	See Table 3	LPS25H	<a href="http://www.st.com/web/catalog/sense_power/FM89/SC1316/PF255230">http://www.st.com/web/catalog/sense_power/FM89/SC1316/PF255230</a>
Accelerometer/ Gyroscope	U4	I2C	See Table 3	LSM330DLC	<a href="http://www.st.com/web/en/catalog/sense_power/FM89/SC1448/PF252427">http://www.st.com/web/en/catalog/sense_power/FM89/SC1448/PF252427</a>
Heart Rate & Oxygen Sensor	U6	—	—	SFH7050	<a href="http://www.osram-os.com/osram_os/en/products/product-promotions/infrared-products/sensor-family/biomon-sensor-sfh-7050/index.jsp">http://www.osram-os.com/osram_os/en/products/product-promotions/infrared-products/sensor-family/biomon-sensor-sfh-7050/index.jsp</a>
Analog Front End	U2	SPI	See Table 4	AFE4403	<a href="http://www.ti.com/product/afe4403">http://www.ti.com/product/afe4403</a>
BLE Module	U5	UART	See Table 5	Seeed 113050012	<a href="http://www.seeedstudio.com/wiki/BLE_Micro">http://www.seeedstudio.com/wiki/BLE_Micro</a>

## Flash Memory Devices

The Lattice MachXO2 and iCE5LP are each equipped with an external SPI Flash memory device.

**Table 15. Flash Devices**

Master Device	Reference Number	Part Number
MachXO2	U5	Micron N25Q032A13ESC40G
iCE5LP	U10	Micron M25P80-VMN6TP

The iCE5LP external Flash memory is intended for holding configuration data, while the MachXO2 external Flash memory is intended for storing data, such as images for the included display. Because of the target application, the Flash device connected to the MachXO2 is capable of using the higher-bandwidth Quad-SPI protocol.

**Table 16. Flash Connections**

Master Device	Reference Number	Signal	FPGA Ball
MachXO2	U5	DQ0	G1
		DQ1	F5
		DQ2	F3
		DQ3	G3
		SCLK	F6
		CS	G7
iCE5LP	U10	MISO	F2
		MOSI	D1
		SCLK	E1
		CS	F1

## Board Configuration and Programming

### Lattice MachXO2

The Lattice MachXO2 features internal configuration Flash. This allows configuration data to be stored internally while the external Flash memory device is used for auxiliary functions.

1. Ensure that header J51 is shunted and the power switch (SW2) is in the *on* position.
2. Plug in the mini-USB cable (J1).
3. Launch Diamond Programmer.
4. Select **Create a new project from a scan** and click **Detect Cable**.
5. Select the FTUSB-1 Port.
6. Select **MachXO2** and **LCMXO2-2000ZE** in the Device Family and Device columns.
7. Double click on the Operation column and select the appropriate operation.
  - a. Internal Flash: Flash Programming Mode: SPI Flash Erase, Program, Verify
  - b. External Flash: SPI Flash Programming: SPI Flash Erase, Program, Verify
8. If targeting the External Flash memory, copy the SPI Flash Options from Figure 6.
9. Select the programming bitstream in the “File Name” column.
10. Click the Program Icon or select Program from the Design dropdown menu.

Figure 6. MachXO2 External Flash

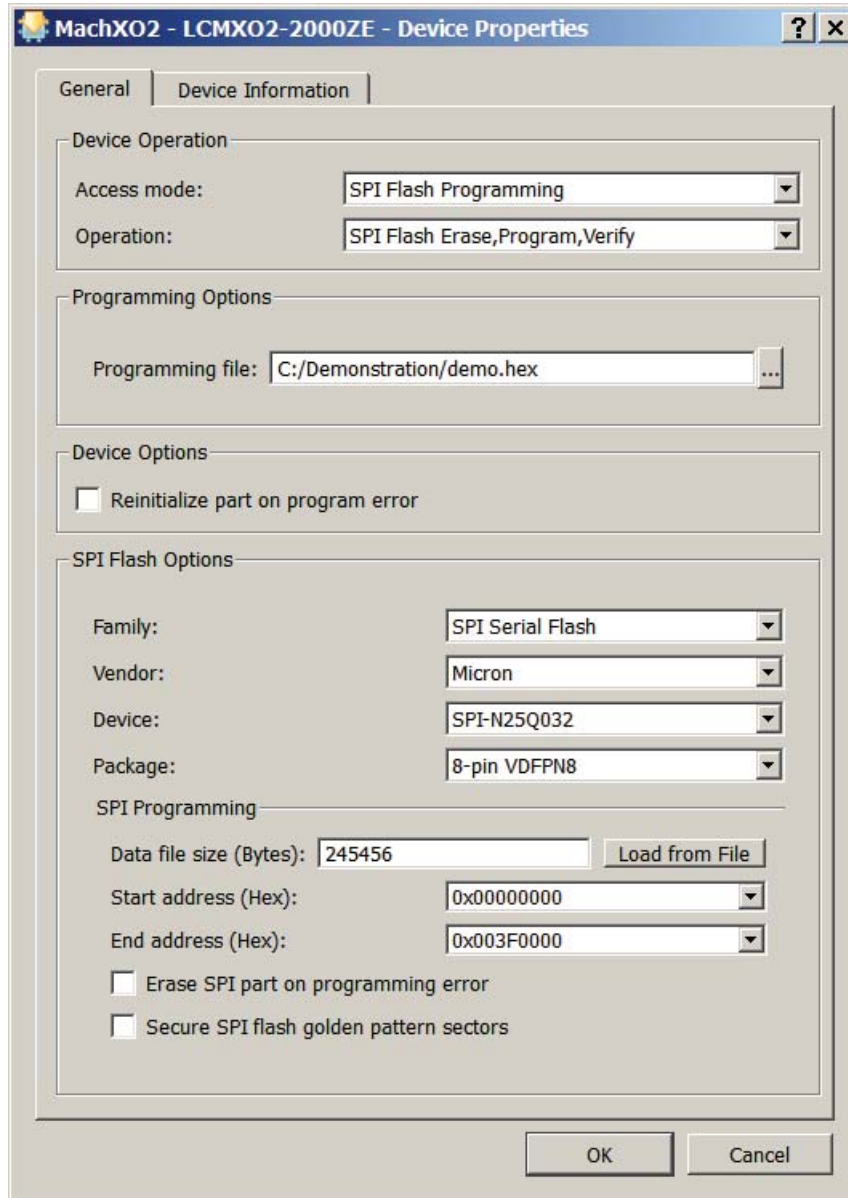

## Lattice iCE5LP

The Lattice iCE5LP can be directly programmed, however, unless single-time programmable NVCM is used, the configuration data will be lost when the device is powered down.

1. Ensure that header J51 is shunted and the power switch (SW2) is in the *on* position.
2. Plug in the mini-USB cable (J1).
3. Launch Diamond Programmer.
4. Select **Create a new project from a scan** and click **Detect Cable**.
5. Select the FTUSB-0 Port.
6. Select **iCE5LP** and **iCE5LP4K** in the Device Family and Device columns.



7. Double click on the Operation column and select the appropriate operation
  - a. Direct Program: CRAM Programming: Fast Program (Volatile)
  - b. NVCM (Single-use): NVCM Programming Mode: NVCM Program, Verify, Secure
  - c. External Flash: SPI Flash Programming: SPI Flash Erase, Program, Verify
8. If targeting the External Flash memory, copy the SPI Flash Options from Figure 7.
9. Select the programming bitstream in the File Name column
10. Click the Program Icon or select Program from the Design dropdown menu

**Figure 7. iCE5LP External Flash**

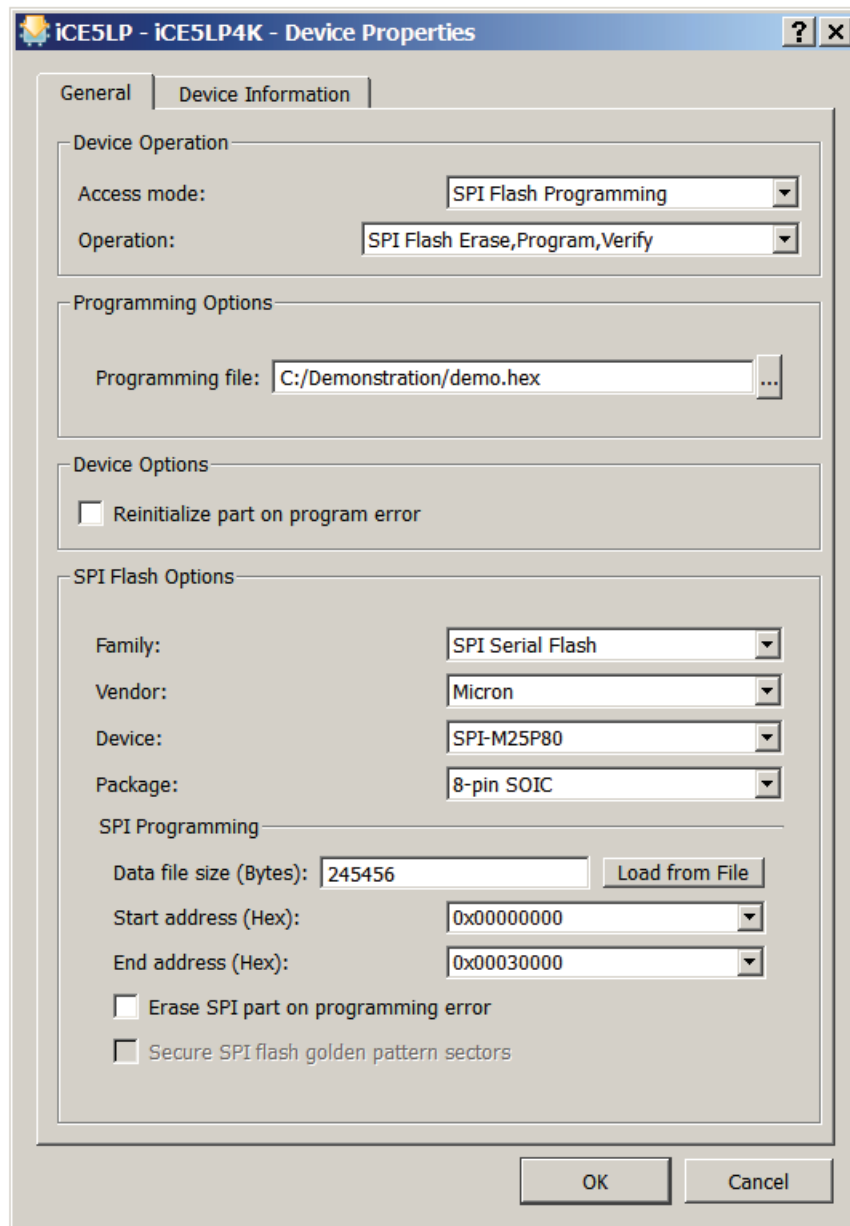

## Pre-Loaded Demonstration Design

The iCE40 Ultra Wearable Development Platform comes pre-loaded with the Parallel-to-MIPI DSI demo. In order to run the demo, follow these steps:

1. Ensure that the display is attached in the proper orientation, with the connector ribbon extending toward the right edge of the device (see Figure 8).

**Figure 8. Display Connector**

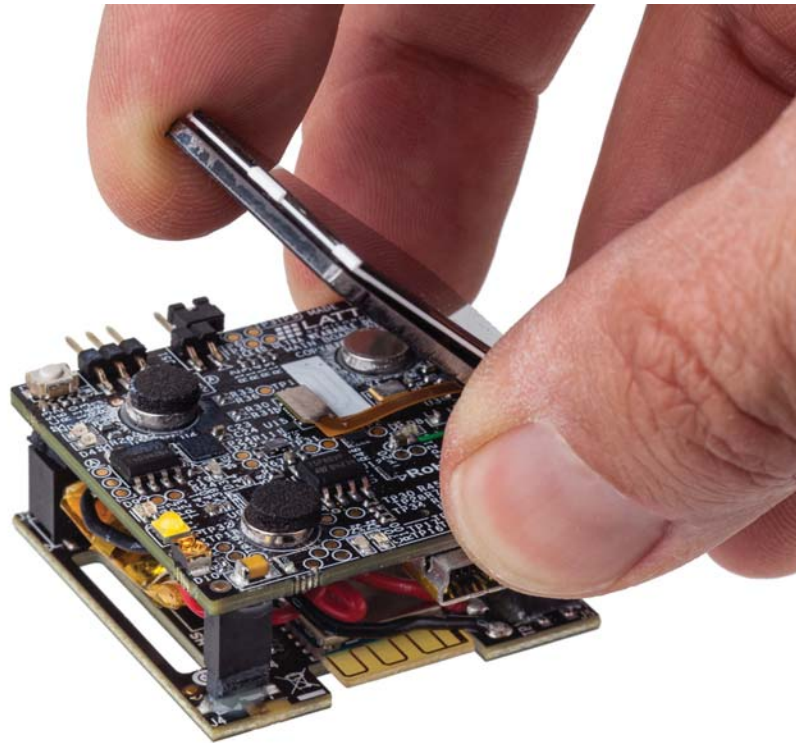

2. Plug a mini-USB cable into the mini-USB port (J1) to supply power to the device.
3. Switch power switch to the *on* position.
4. The screen should alternate between two images, with the User LEDs (D4, D5) indicating the demo mode.

For more detailed operation instructions, please refer to the Quick Start User Guide included with the demo design.

This demo design can be reprogrammed onto the board by downloading the project (see the [Additional Demonstration Designs](#) section) and following the documented instructions. Please note that in this demo, the MachXO2 uses its internal Flash to store configuration data and the external Flash to store image data, so two programming procedures must be performed.

## Additional Demonstration Designs

Several additional demonstration designs have been developed for the iCE40 Ultra Wearable Development Platform. These designs can be found under the Design File Tab of the Documentation section of the board web page here: <http://www.latticesemi.com/ultrawearable>.

## Ordering Information

Description	Ordering Part Number	China RoHS Environment-Friendly Use Period (EFUP)
iCE40 Ultra Wearable Development Platform	ICE5LP4K-WDEV-EVN	

## Technical Support Assistance

Submit a technical support case through [www.latticesemi.com/techsupport](http://www.latticesemi.com/techsupport).

## Revision History

Date	Version	Change Summary
July 2015	1.0	Initial release.

© 2015 Lattice Semiconductor Corp. All Lattice trademarks, registered trademarks, patents, and disclaimers are as listed at [www.latticesemi.com/legal](http://www.latticesemi.com/legal). All other brand or product names are trademarks or registered trademarks of their respective holders. The specifications and information herein are subject to change without notice.

## Appendix A. Main Board Schematic Diagrams

Figure 9. Block Diagram

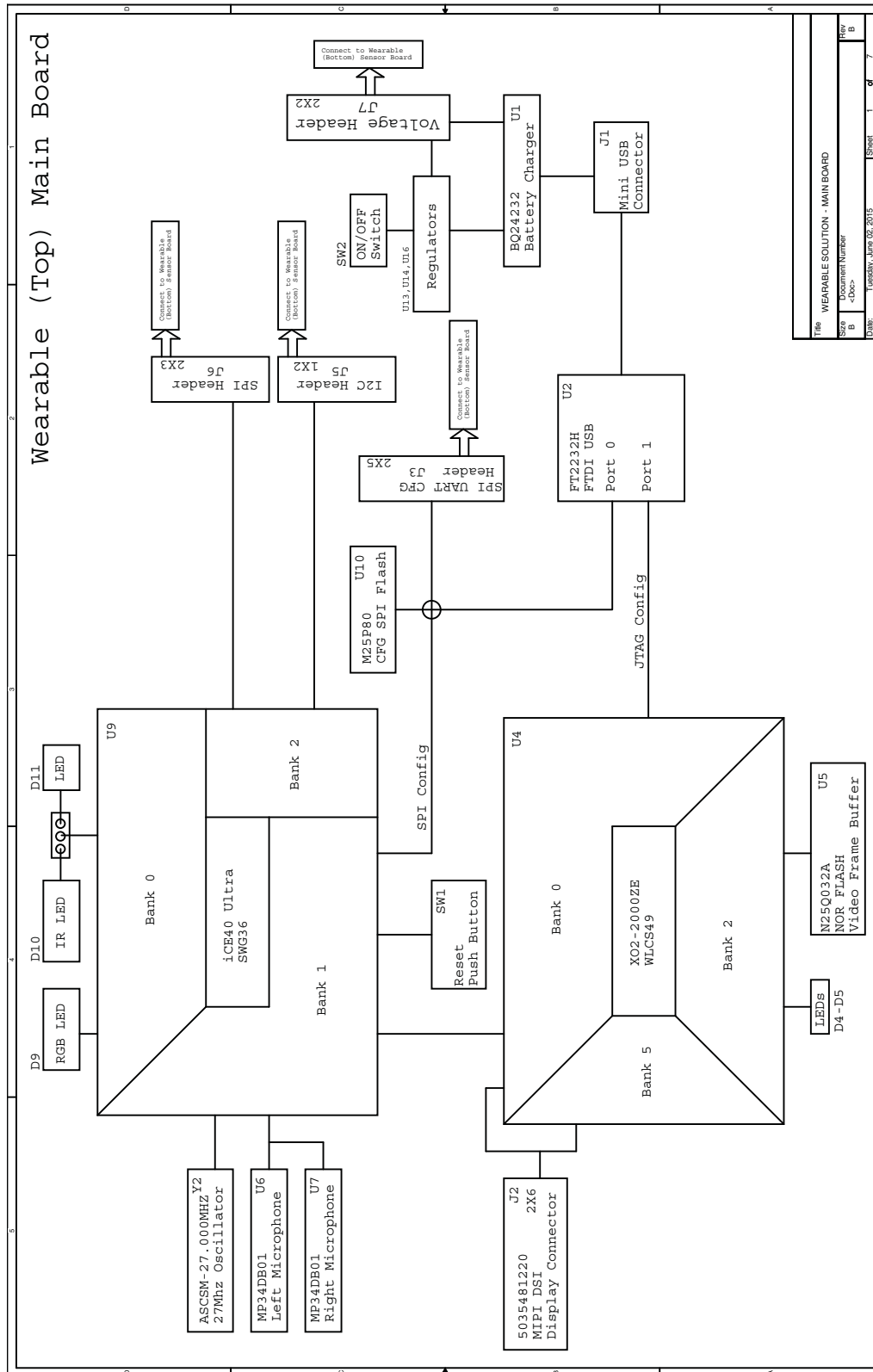

Figure 10. Mechanical Design

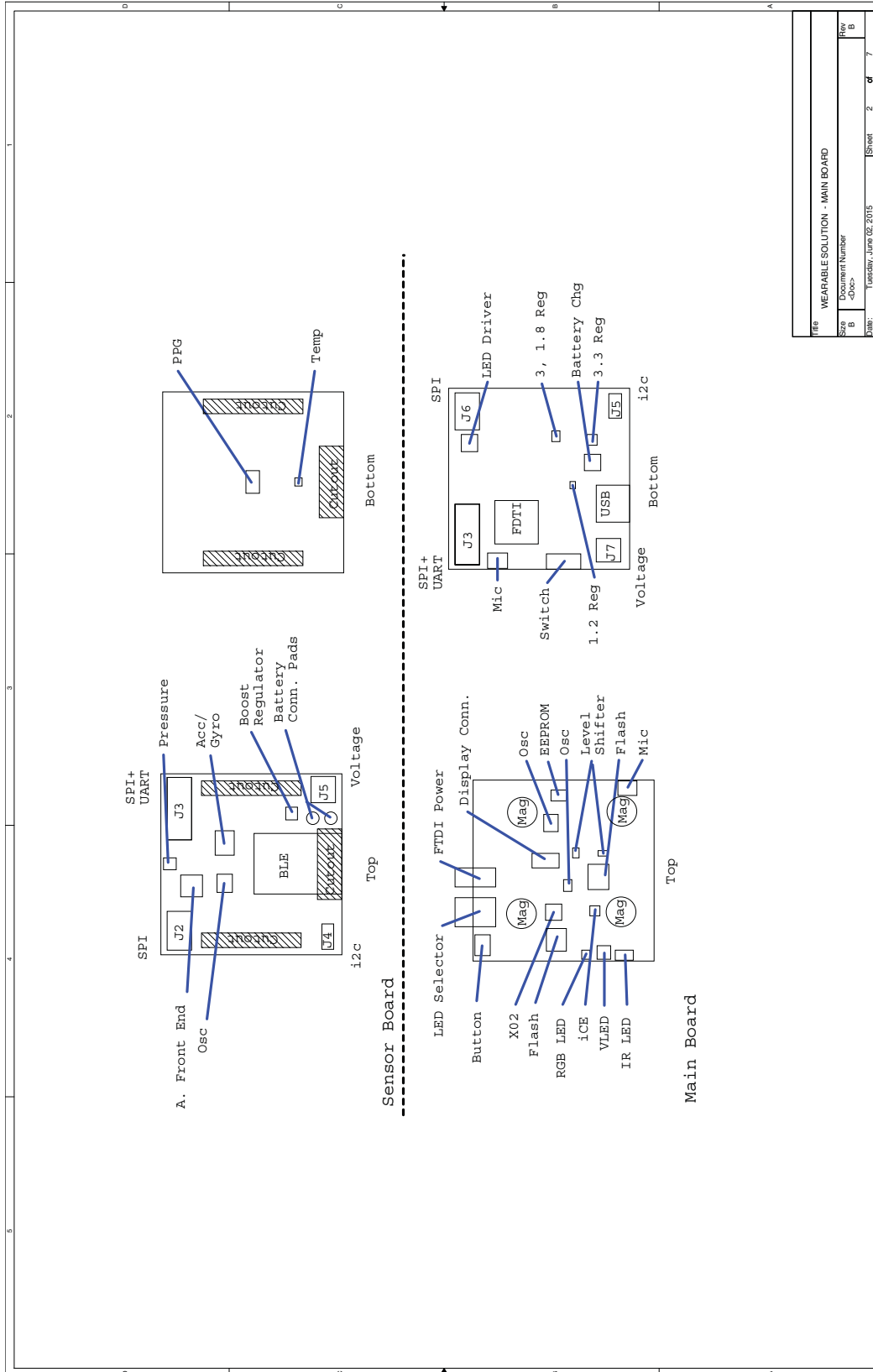

Figure 11. Battery Charger Connections

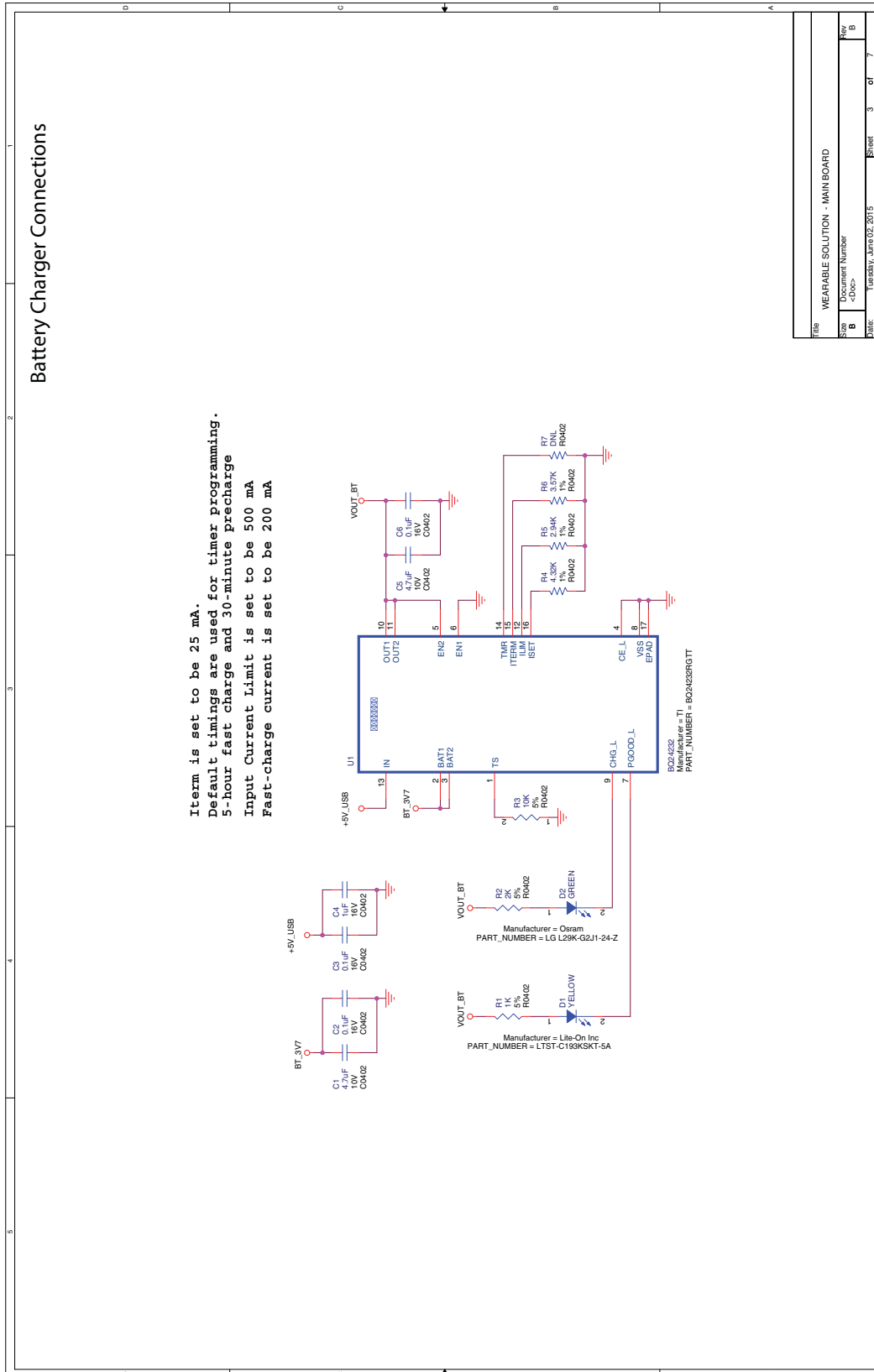
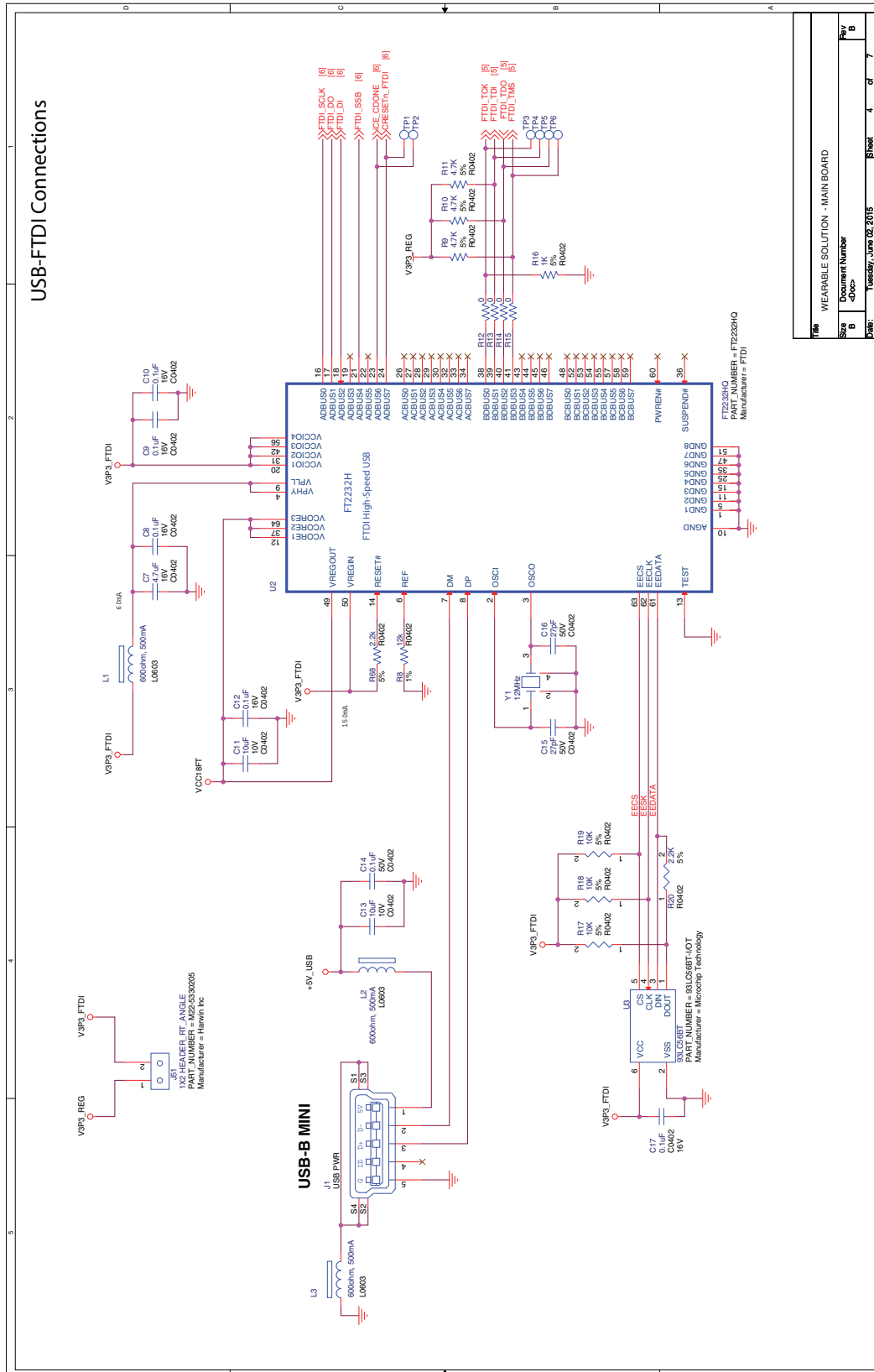

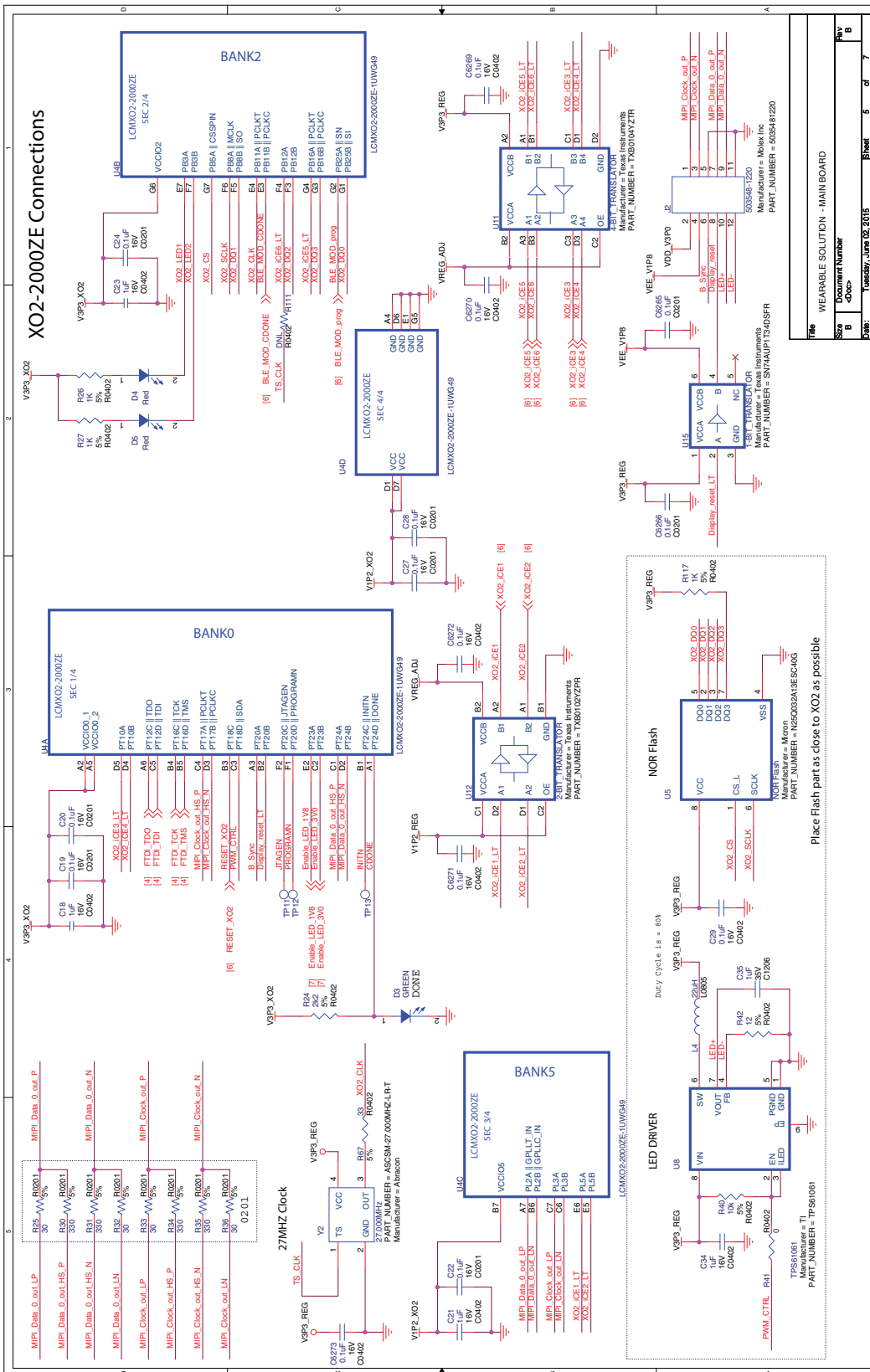

Figure 12. USB-FTDI Connections



WEARABLE SOLUTION - MAIN BOARD						
File	Document Number	Rev	By	Date	Drawn	Checked
Size	B					
Doc#						
Version	1.0	1	1	12/10/15	1	1

Figure 13. MachXO2-2000ZE Connections



Place Flash part as close to XO2 as possible

Rev	Doc	Sheet	of
B	0000	5	7

Figure 14. iCE5LP4K Connections

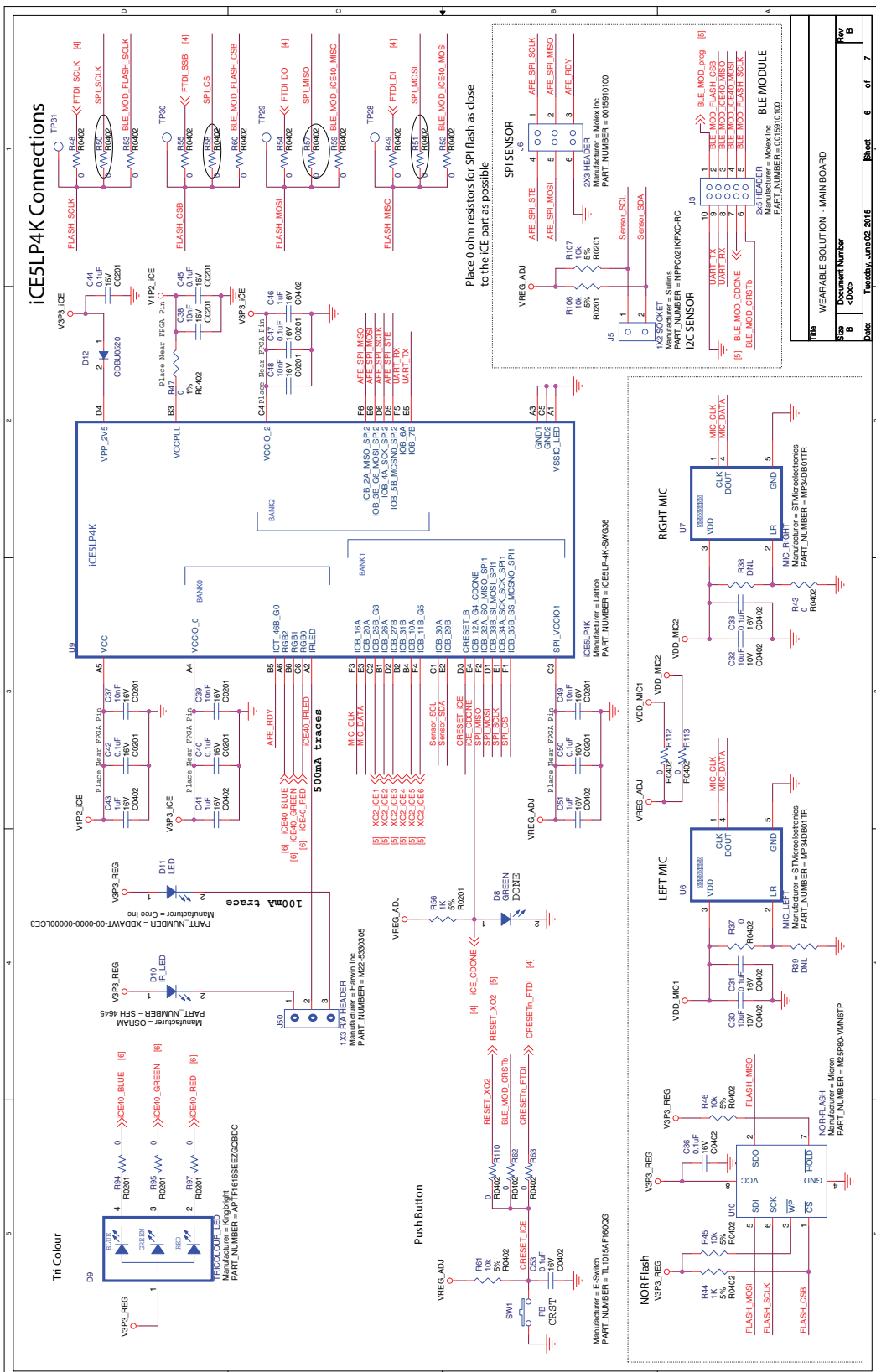
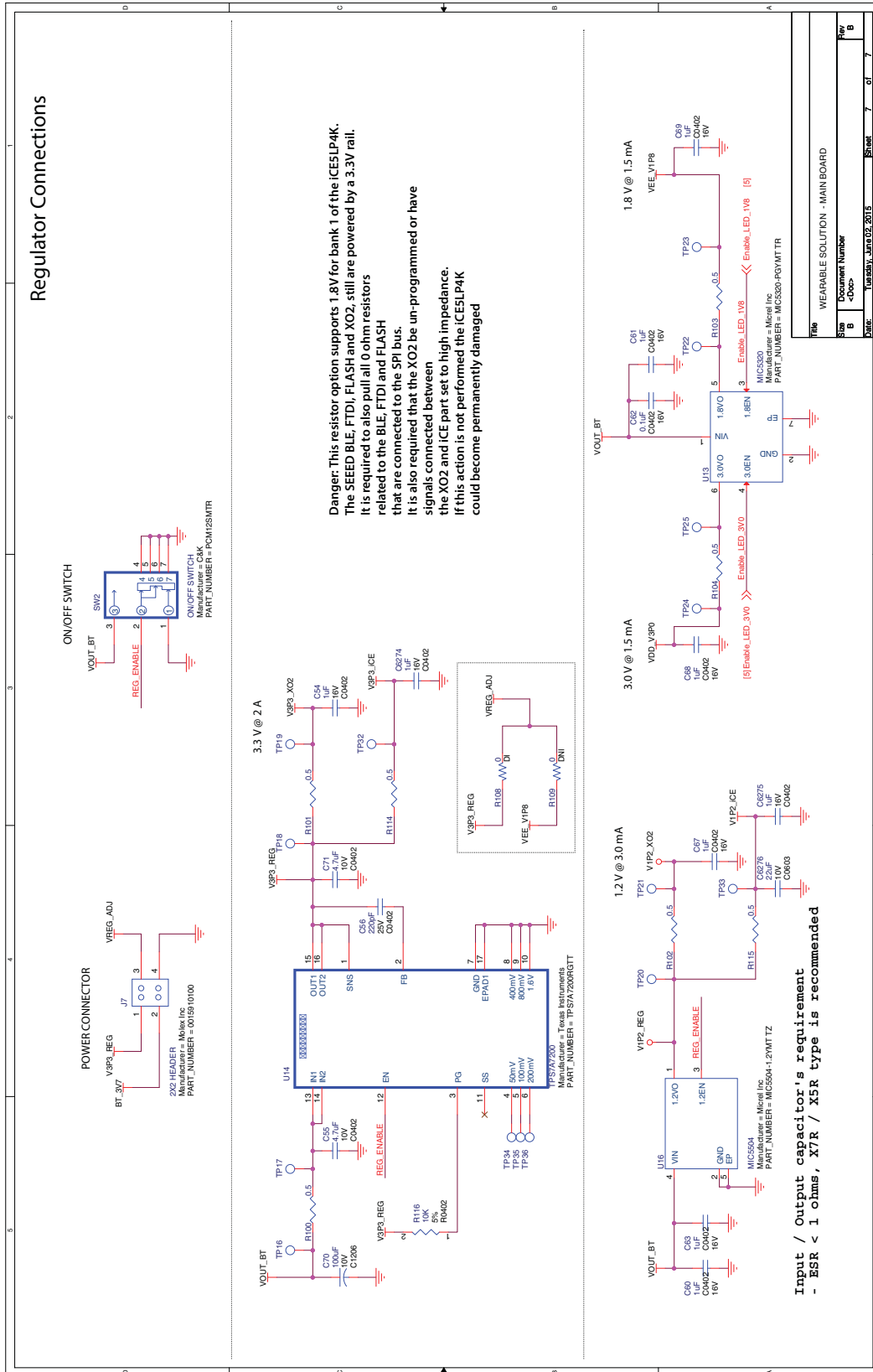

Figure 15. Regulator Connections



## Appendix B. Sensor Board Schematic Diagrams

Figure 16. Block Diagram

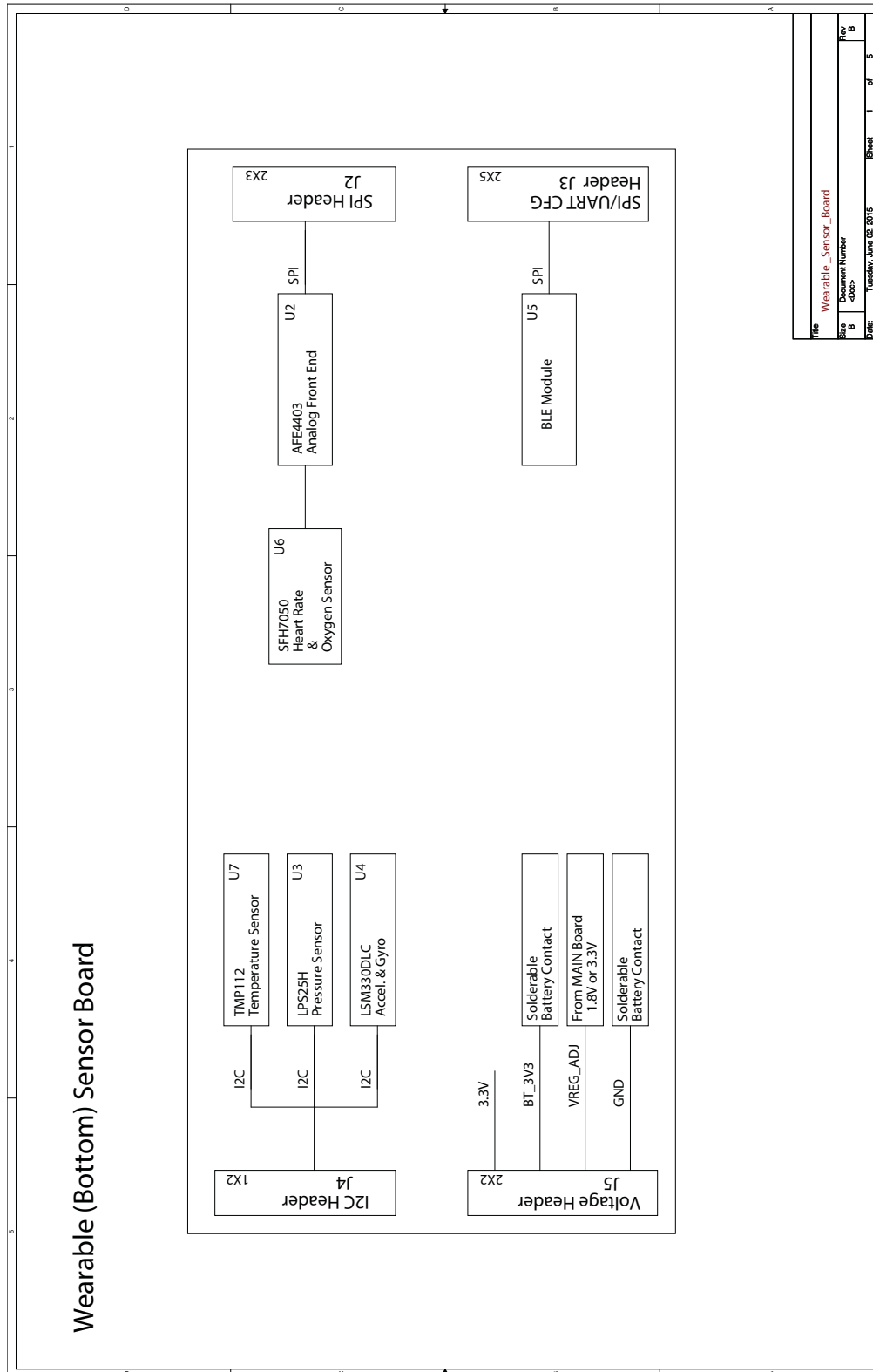

Figure 17. Mechanical Design

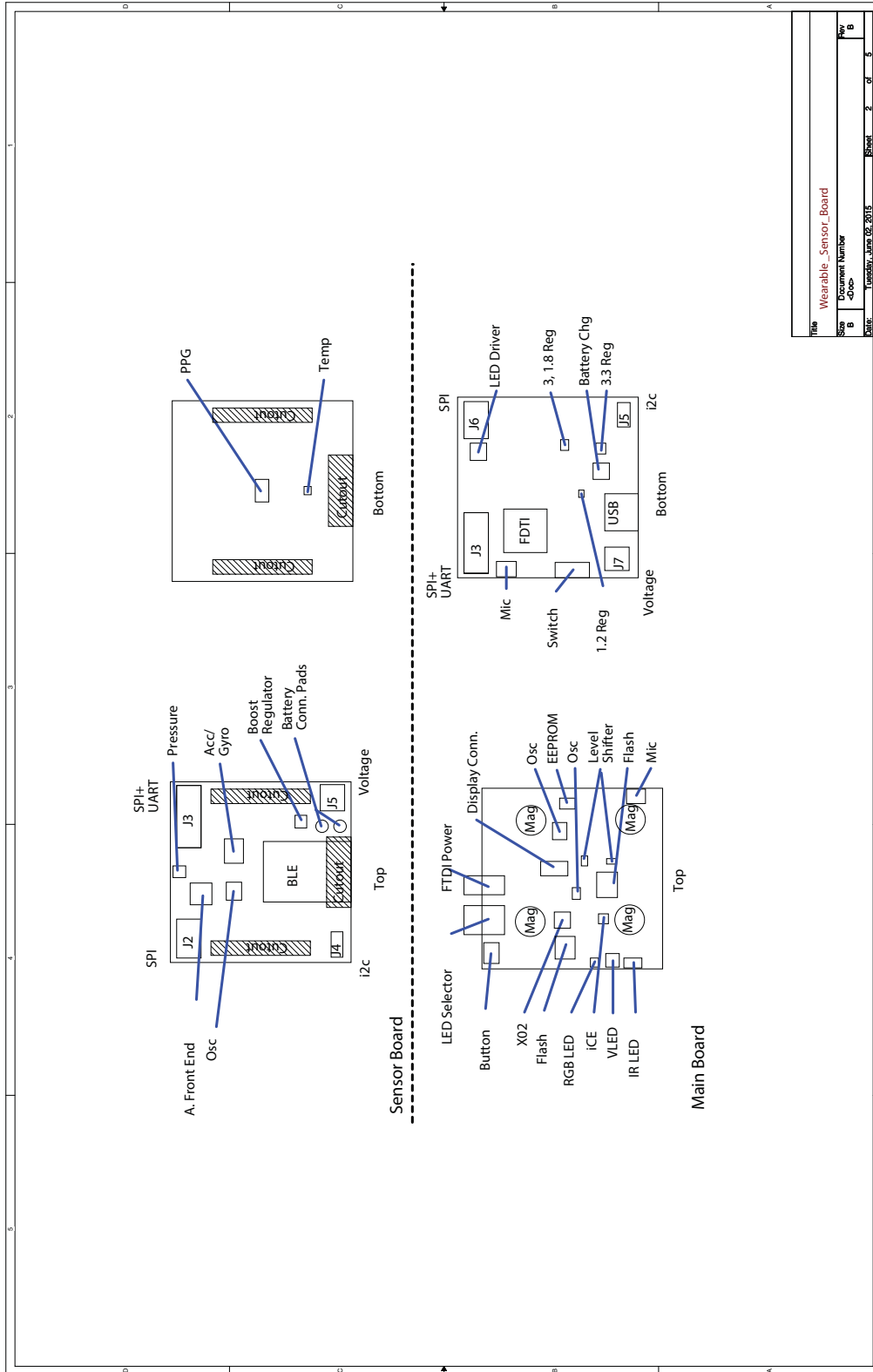



Figure 18. Sensor Connections - 1

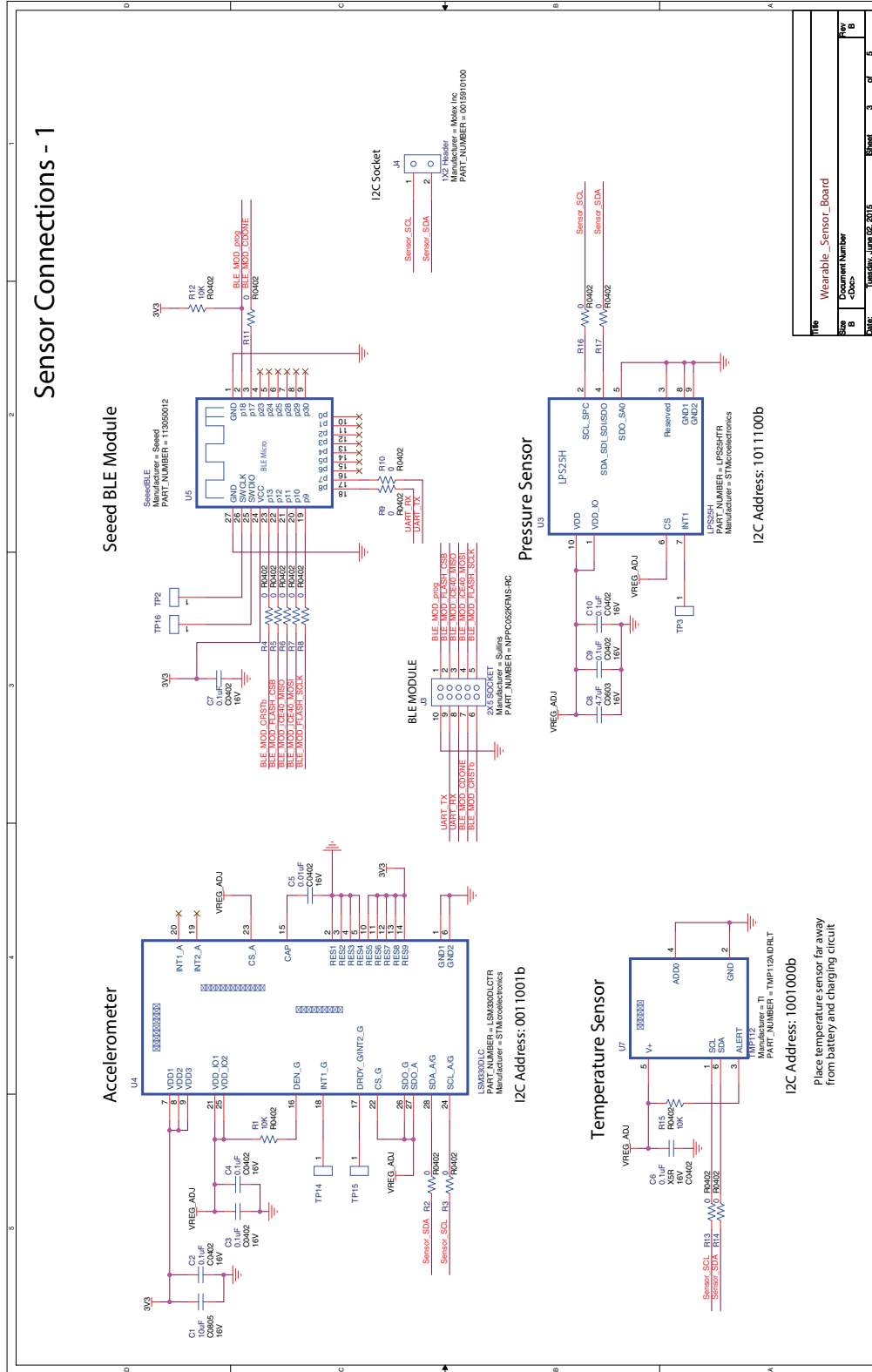

Figure 19. Sensor Connections - 2

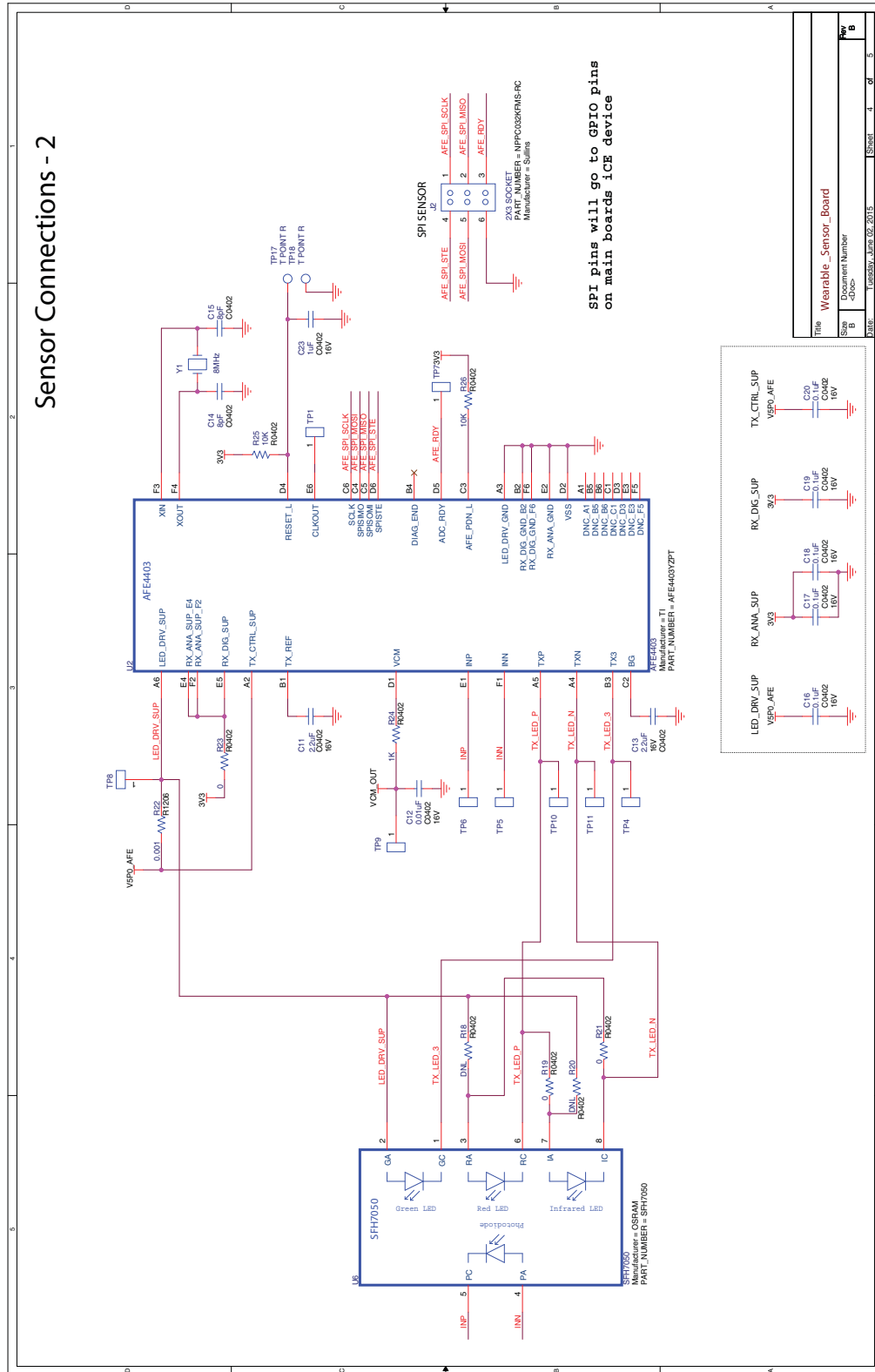
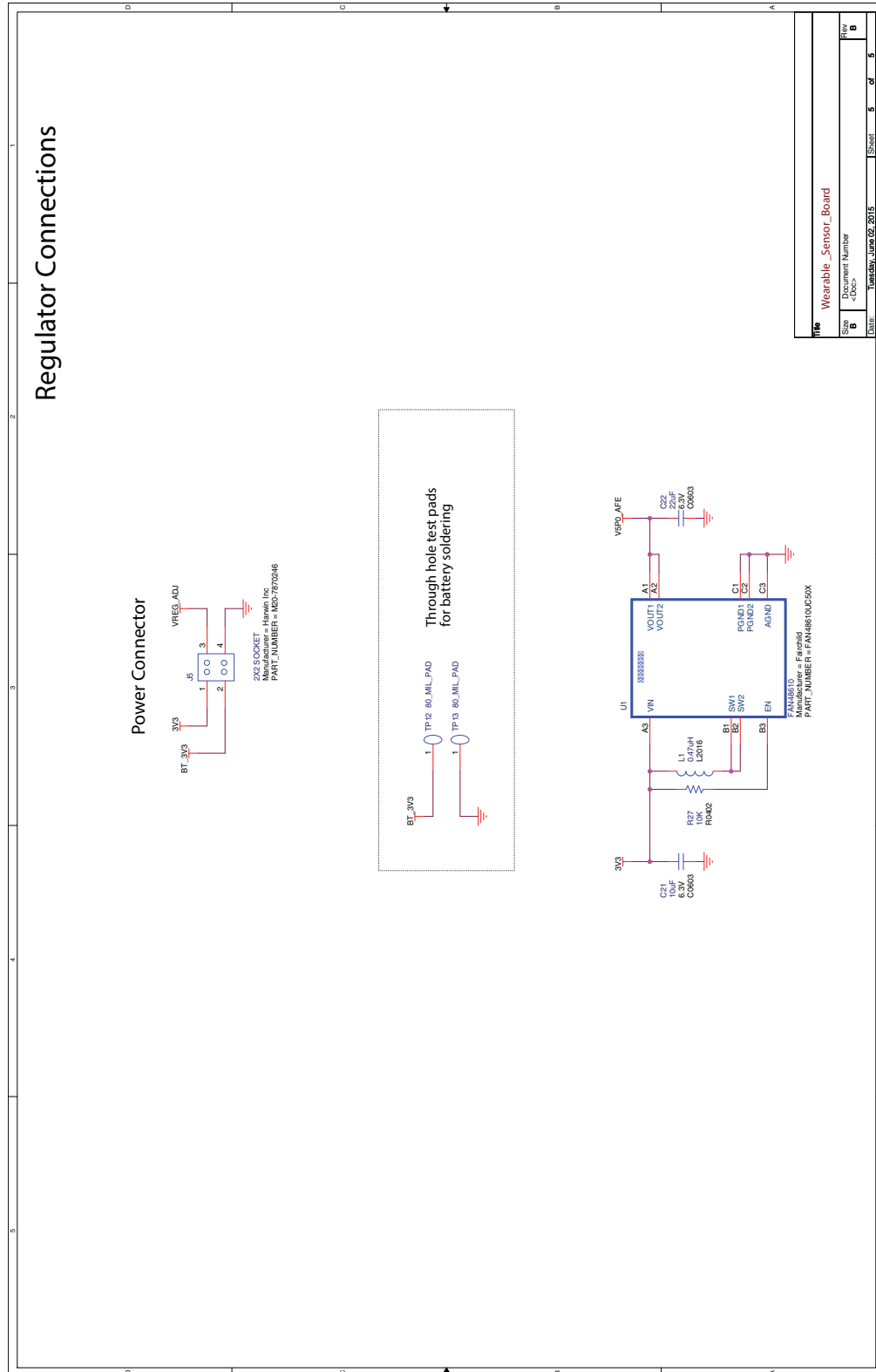

Figure 20. Boost Regulator



## Appendix C. Main Board Bill of Materials

Figure 21. Main Board Bill of Materials

Item	Reference	Qty	Part	PCB Footprint	Comments	Part Number	Manufacturer	Description
1	C1,C5,C55,C71	4	4.7uF	C0402	—	C1005X5R1A475K050BC	TDK	CAP CER 4.7 µF 10 V 10% X5R 0402
2	C2,C3,C6,C6269,C6270,C6271,C6272	7	0.1uF	C0402	—	C1005X5R1C104K050BA	TDK	CAP CER 0.1 µF 16 V 10% X5R 0402
3	C4	1	1uF	C0402	—	GRM155R61C105KE01D	Murata	CAP CER 1 µF 16 V 10% X5R 0402
4	C7	1	4.7uF	C0402	—	C1005X5R1A475K050BC	TDK	CAP CER 4.7 µF 10 V 10% X5R 0402
5	C8,C9,C10,C12,C14,C17,C29,C31,C33,C36,C53,C62,C6273	13	0.1uF	C0402	—	C1005X5R1C104K050BA	TDK	CAP CER 0.1 µF 16 V 10% X5R 0402
6	C11,C13,C30,C32	4	10uF	C0402	—	CL05A106MP5NUNC	Samsung	CAP CER 10 µF 10 V 20% X5R 0402
7	C15,C16	2	27pF	C0402	—	CL05C270JB5NUNC	Samsung	CAP CER 27 pF 50 V 5% NP0 0402
8	C18,C21,C23,C34,C41,C43,C46,C51,C54,C60,C61,C63,C67,C68,C69,C6274,C6275	17	1uF	C0402	—	GRM155R61C105KE01D	Murata	CAP CER 1 µF 16 V 10% X5R 0402
9	C19,C20,C22,C24,C27,C28,C40,C42,C44,C45,C47,C50	12	0.1uF	C0201	—	C0603X5R1C104K030BC	TDK	CAP CER 0.1 µF 16 V 10% X5R 0201
10	C35	1	1uF	C1206	—	GMK316BJ105KLHT	Taiyo Yuden	CAP CER 1 µF 35 V 10% X5R 1206
11	C37,C38,C39,C48,C49	5	10nF	C0201	—	GRM033R61C103KA12D	Murata	CAP CER 10000 pF 16 V 10% X5R 0201
12	C56	1	220pF	C0402	—	GRM1555C1E221JA01D	Murata	CAP CER 220 pF 25 V 5% NP0 0402
13	C70	1	100uF	C1206	—	F951A107KAAQ2	AVX	CAP TANT 100 µF 10 V 10% 1206
14	C6265,C6266	2	0.1uF	C0201	—	C0603X5R1E104M030BB	TDK Corporation	CAP CER 0.1 µF 25 V 20% X5R 0201
15	C6276	1	22uF	C0603	—	C1608X5R1A226M080A C	TDK	CAP CER 22 µF 10 V 20% X5R 0603
16	D1	1	YELLOW	LED0603	—	LTST-C193KSKT-5A	Lite-On Inc	LED YELLOW RECT CLEAR 0603
17	D2	1	GREEN	LED0603	—	LG L29K-G2J1-24-Z	Osram	LED SMARTLED GREEN 570NM 0603
18	D3,D8	2	GREEN	LED0603	—	LG L29K-G2J1-24-Z	Osram	LED SMARTLED GREEN 570NM 0603
19	D4,D5	2	Red	LED0603	—	LTST-C190KRKT	LITE-ON INC	LED SUPER RED CLEAR 0603 SMD
20	D9	1	TRICOLOUR_LED	APTF1616SE_RGB	—	APTF1616SEEZQBDC	Kingbright	LED RED/GREEN/BLUE WTR CLEAR SMD
21	D10	1	IR_LED	SFH4645_2SMD	—	SFH 4645	OSRAM	EMITTER 950NM MIDLED SIDELK SMD
22	D11	1	LED	XBDAWT_2SMD	—	XBDAWT-00-0000-00000LCE3	Cree Inc	LED HIGH BRIGHTNESS
23	D12	1	CDBU0520	DIODE_SOD523F	—	CDBU0520	Comchip	DIODE SCHOTTKY 20 V 500 mA 0603
24	J1	1	USB PWR	CONN_S5P1RMINIUS_BB_MOLEX	—	67503-1020	Molex	CONN RECEPT MINI-USB R/A 5POS SMD
25	J2	1	503548-1220	2X6HDR_5035481220	—	5035481220	Molex Inc	CONN RCPT BTB 12POS DL VERT SMD
26	J3	1	2x5 HEADER	2X5_HDR_SMD	BREAKAWAY PART	15910100	Molex Inc	CONN HEADER 10POS .100" STR 15AU
27	J5	1	1X2 SOCKET	1X2_SOCKET_SMD	—	NPPC021KFXC-RC	Sullins	CONN FEMALE 2POS .1" SMD GOLD
28	J6	1	2X3 HEADER	2X3_HDR_SMD	BREAKAWAY PART	15910100	Molex Inc	CONN HEADER 10POS .100" STR 15AU
29	J7	1	2X2 HEADER	2X2_HDR_SMD	BREAKAWAY PART	15910100	Molex Inc	CONN HEADER 10POS .100" STR 15AU
30	J50	1	1X3 R/A HEADER	1X3_HDRRAM22_SMD	—	M22-5330305	Harwin Inc	3 WAY SIL HORIZ SMT PIN HDR
31	J51	1	1X2 HEADER_RT_ANGLE	1X2_HDRM22_SMD	—	M22-5330205	Harwin Inc	2POS SIL HORIZ SMT PIN HEADER

Item	Reference	Qty	Part	PCB Footprint	Comments	Part Number	Manufacturer	Description
32	L1,L2,L3	3	600ohm, 500mA	L0603	—	MMZ1608R601A	TDK Corp	FERRITE CHIP 600 Ohm 500 mA 0603
33	L4	1	22uH	L0805	—	AIML-0805HC-220M-T	Abracon Corporation	HIGH CURRENT CHIP IND 22.0UH 20%
34	R1	1	1K	R0402	—	ERJ-2GEJ102X	Panasonic	RES SMD 1K Ohm 5% 1/10W 0402
35	R2	1	2K	R0402	—	ERJ-2GEJ202X	Panasonic	RES SMD 2K Ohm 5% 1/10W 0402
36	R3,R116	2	10K	R0402	—	ERJ-2GEJ103X	Panasonic	RES SMD 10K Ohm 5% 1/10W 0402
37	R4	1	4.32K	R0402	—	ERJ-2RKF4321X	Panasonic	RES SMD 4.32K Ohm 1% 1/10W 0402
38	R5	1	2.94K	R0402	—	ERJ-2RKF2941X	Panasonic	RES SMD 2.94K Ohm 1% 1/10W 0402
39	R6	1	3.57K	R0402	—	ERJ-2RKF3571X	Panasonic	RES SMD 3.57K Ohm 1% 1/10W 0402
40	R7	1	DNL	R0402	DNL	—	—	—
41	R8	1	12k	R0402	—	ERJ-2RKF1202X	Panasonic	RES SMD 12K Ohm 1% 1/10W 0402
42	R9,R10,R11	3	4.7K	R0402	—	ERJ-2GEJ472X	Panasonic	RES SMD 4.7K Ohm 5% 1/10W 0402
43	R12,R13,R14,R15,R37,R43,R48,R49,R50,R51,R52,R53,R54,R55,R57,R58,R59,R60,R62,R63,R112,R113	22	0	R0402	—	ERJ-2GE0R00X	Panasonic	RES SMD 0.0 Ohm JUMPER 1/10W 0402
44	R16,R26,R27,R44	4	1K	R0402	—	ERJ-2GEJ102X	Panasonic	RES SMD 1K Ohm 5% 1/10W 0402
45	R17,R18,R19,R40,R45,R46,R61	7	10k	R0402	—	ERJ-2GEJ103X	Panasonic	RES SMD 10K Ohm 5% 1/10W 0402
46	R20,R68	2	2.2k	R0402	—	ERJ-2GEJ222X	Panasonic	RES SMD 2.2K Ohm 5% 1/10W 0402
47	R24	1	2k2	R0402	—	ERJ-2GEJ222X	Panasonic	RES SMD 2.2K Ohm 5% 1/10W 0402
48	R25,R32,R33,R36	4	30	R0201	—	ERJ-1GEJ300C	Panasonic	RES 30 Ohm 1/20W 5% 0201 SMD
49	R30,R31,R34,R35	4	330	R0201	—	CRCW0201330RJNED	Vishay	RES 330 Ohm 1/20W 5% 0201 SMD
50	R38,R39	2	DNL	R0402	DNL	—	—	—
51	R41	1	0	R0402	—	ERJ-2GE0R00X	Panasonic	RES SMD 0.0 Ohm JUMPER 1/10W 0402
52	R42	1	12	R0402	—	ERJ-2GEJ120X	Panasonic	RES SMD 12 Ohm 5% 1/10W 0402
53	R47	1	0	R0402	—	ERJ-2GE0R00X	Panasonic	RES SMD 0.0 Ohm JUMPER 1/10W 0402
54	R56	1	1K	R0201	—	ERJ-1GEJ102C	Panasonic	RES SMD 1K Ohm 5% 1/20W 0201
55	R67	1	33	R0402	—	ERJ-2GEJ330X	Panasonic	RES SMD 33 Ohm 5% 1/10W 0402
56	R94,R95,R97	3	0	R0201	—	ERJ-1GN0R00C	Panasonic	RES SMD 0.0 Ohm JUMPER 1/20W 0201
57	R100,R101,R102,R103,R104,R114,R115	7	0.5	Current_Sens_Res_0603	—	RL0603FR-070R5L	Yageo	RES SMD 0.5 Ohm 1% 1/10W 0603
58	R106,R107	2	10k	R0201	—	ERJ-1GEJ103C	Panasonic	RES SMD 10K Ohm 5% 1/20W 0201
59	R108	1	0	R0603	—	ERJ-3GEY0R00V	Panasonic	RES SMD 0.0 Ohm JUMPER 1/10W 0603
60	R109	1	0	R0603	DNL	ERJ-3GEY0R00V	Panasonic	RES SMD 0.0 Ohm JUMPER 1/10W 0603
61	R110	1	0	R0402	—	ERJ-2GE0R00X	Panasonic	RES SMD 0.0 Ohm JUMPER 1/10W 0402
62	R111	1	DNL	R0402	DNL	—	—	—
63	R117	1	1K	R0402	—	ERJ-2GEJ102X	Panasonic	RES SMD 1K Ohm 5% 1/10W 0402
64	SW1	1	PB	2psmd_eswitch	—	TL1015AF160QG	E-Switch	SWITCH TACTILE SPST-NO 0.05A 12 V
65	SW2	1	ON/OFF SWITCH	PCM12SMTR	—	PCM12SMTR	C&K	SWITCH SLIDE SPDT 300 mA 6 V

Item	Reference	Qty	Part	PCB Footprint	Comments	Part Number	Manufacturer	Description
66	TP1,TP2,TP3,TP4,TP5,TP6,TP11,TP12,TP13,TP16,TP17,TP18,TP19,TP20,TP21,TP22,TP23,TP24,TP25,TP32,TP33,TP34,TP35,TP36	24	T POINT R	TEST_POINT	DNL	—	—	—
67	TP28,TP29,TP30,TP31	4	T POINT R	TEST_POINT	DNL	—	—	—
68	U1	1	BQ24232	BQ24232_16VQFN	—	BQ24232RGTT	TI	IC LI+ CHARGER PWR MGMT 16QFN
69	U2	1	FT2232HQ	FT2232HQ_64QFN	—	FT2232HQ	FTDI	IC USB HS DUAL UART/FIFO 64-QFN
70	U3	1	93LC56BT	93LC56BT_6SOT23	—	93LC56BT-I/OT	Microchip Technology	IC EEPROM 2KBIT 2MHZ SOT23-6
71	U4	1	LCMXO2-2000ZE-1UWG49	XO2_2000ZE_49CSP	CUSTOMER SUPPLIED	LCMXO2-2000ZE-1UWG49	Lattice	LCMXO2-2000ZE-1UWG49
72	U5	1	NOR Flash	N25Q032A_8SOIC	—	N25Q032A13ESC40G	Micron	IC FLASH 32MBIT 108MHZ 8SO
73	U6	1	MIC_LEFT	MP34DB01_RHLGA	—	MP34DB01TR	STMicroelectronics	MIC MEMS DIGITAL PDM OMNI -26DB
74	U7	1	MIC_RIGHT	MP34DB01_RHLGA	—	MP34DB01TR	STMicroelectronics	MIC MEMS DIGITAL PDM OMNI -26DB
75	U8	1	TPS61061	TPS61061_8QFN	—	TPS61061DRBR	TI	IC LED DRIVER WHITE BCKLGT 8SON
76	U9	1	iCE5LP4K	iCE5LP4K_SWG36	CUSTOMER SUPPLIED	iCE5LP-4K-SWG36	Lattice	iCE40 Ultra family is an ultra-low power FPGA and sensor manager
77	U10	1	NOR-FLASH	M25P80_SO8N	—	M25P80-VMN6TP	Micron	IC FLASH 8MBIT 75MHZ 8SO
78	U11	1	4-BIT_TRANSLATOR	12DSBGA_TXB0104	—	TXB0104YZTR	Texas Instruments	IC XLATR VOLT-LVL 4B ESD 12DSBGA
79	U12	1	2-BIT_TRANSLATOR	8DSBGA_TXB0102	—	TXB0102YZPR	Texas Instruments	IC 2BIT V-TRANS-LATR W/ESD 8DSBGA
80	U13	1	MIC5320	MIC5320_6MLF	—	MIC5320-PGYMT TR	Micrel Inc	IC REG LDO 3 V/1.8 V 0.15A 6TMLF
81	U14	1	TPS7A7200	TPS7A7200_16QFN	—	TPS7A7200RGTT	Texas Instruments	IC REG LDO FIX/ADJ 2A 16QFN
82	U15	1	1-BIT_TRANSLATOR	6SON_SN74AUP1T34	—	SN74AUP1T34DSFR	Texas Instruments	IC V-LEVEL XLATR UNIDIR 6SON
83	U16	1	MIC5504	MIC5504_4TDFN	—	MIC5504-1.2YMT TZ	Micrel Inc	IC REG LDO 1.2 V 0.3A 4TDFN
84	Y1	1	12MHz	403C35D12M00000_4 SMD	—	403C35D12M00000	Abracon Corp	CRYSTAL 12MHZ 18 pF SMD
85	Y2	1	27.000MHz	OSC_ASCSM	—	ASCSCM-27.000MHZ-LR-T	Abracon	OSC XO 27.000MHZ CMOS SMD
86	WEARABLE SOLUTION MAIN BOARD PCB	1	—	—	—	305-PD-15-0069	PACTRON	—
87	LCD Display	1	<a href="http://www.vcdisplay.com">www.vcdisplay.com</a> - David Fontano / david@vcdisplay.com	LH154Q01-TD01	LG	<a href="http://vcdisplay.com">http://vcdisplay.com</a>		
88	Battery	1	<a href="http://www.ebay.com">http://www.ebay.com</a>	S107-19 or 652030	Syma	3.7 V 240mAh Li-Po Battery for SYMA S026 RC Remote Quadcopter - bag & tag item		
89	Magnet	8	<a href="http://www.amazon.com">http://www.amazon.com</a>	???	MyMagnetMan	MyMagnetMan® 1/4" x 1/16" (6.35 x 1.58mm) 3M-467 Adhesive Rare Earth Neodymium Disc Magnets for Crafts		



## Appendix D. Sensor Board Bill of Materials

**Figure 22. Sensor Board Bill of Materials**

Item	Reference	Qty	Part	PCB Footprint	Comments	Part Number	Manufacturer	Description
1	C1	1	10uF	C0805	—	C2012X5R1C106K085AC	TDK	CAP CER 10 $\mu$ F 16 V 10% X5R 0805
2	C2,C3,C4,C6,C7,C9,C10,C16,C17,C18,C19,C20	12	0.1uF	C0402	—	C1005X5R1C104K050BA	TDK	CAP CER 0.1 $\mu$ F 16 V 10% X5R 0402
3	C5,C12	2	0.01uF	C0402	—	GRM155R61C103KA01D	Murata	CAP CER 10000 pF 16 V 10% X5R 0402
4	C8	1	4.7uF	C0603	—	EMK107ABJ475KA-T	Taiyo Yuden	CAP CER 4.7 $\mu$ F 16 V 10% X5R 0603
5	C11,C13	2	2.2uF	C0402	—	C1005X5R1C225K050BC	TDK	CAP CER 2.2 $\mu$ F 16 V 10% X5R 0402
6	C14,C15	2	8pF	C0402	—	GRM1555C1E8R0CA01D	Murata	CAP CER 8 pF 25 V NP0 0402
7	C21	1	10uF	C0603	—	C1608X5R0J106K080AB	TDK	CAP CER 10 $\mu$ F 6.3 V 10% X5R 0603
8	C22	1	22uF	C0603	—	C1608X5R0J226M080AC	TDK	CAP CER 22 $\mu$ F 6.3 V 20% X5R 0603
9	C23	1	1uF	C0402	—	C1005X5R1C105K050BC	TDK	CAP CER 1 $\mu$ F 16 V 10% X5R 0402
10	J2	1	2X3 SOCKET	2X3_SOCKET_SMD	—	NPPC032KFMS-RC	Sullins	CONN FEMALE 6POS DL .1" GOLD SMD
11	J3	1	2X5 SOCKET	2X5_SOCKET_SMD	—	NPPC052KFMS-RC	Sullins	CONN FEMALE 10POS DL .1" GOLD SMD
12	J4	1	1X2 Header	1X2_HDR_SMD	BREAKAWAY PART	15910100	Molex Inc	CONN HEADER 10POS .100" STR 15AU
13	J5	1	2X2 SOCKET	2X2_SOCKET_SMD	—	M20-7870246	Harwin Inc	02+02 DIL SMT SKT
14	L1	1	0.47uH	L2016	—	1286AS-H-R47M	Toko	Inductor 0.47uH DFE201612C series
15	R1,R12,R15,R25,R26,R27	6	10K	R0402	—	ERJ-2RKF1002X	Panasonic	RES 10K Ohm 1/10W 1% 0402 SMD
16	R2,R3,R4,R5,R6,R7,R8,R9,R10,R11,R13,R14,R16,R17,R19,R21,R23	17	0	R0402	—	ERJ-2GE0R00X	Panasonic	RES 0.0 Ohm 1/10W 0402 SMD
17	R18,R20	2	DNL	R0402	DNL	—	—	—
18	R22	1	0.001	R1206	—	CSNL1206FT1L00	Stackpole	RES SMD 0.001 Ohm 1% 1W 1206
19	R24	1	1K	R0402	—	ERJ-2RKF1001X	Panasonic	RES 1K Ohm 1/10W 1% 0402 SMD
20	TP1,TP2,TP3,TP4,TP5,TP6,TP7,TP8,TP9,TP10,TP11,TP14,TP15,TP16	14	TEST POINT	TEST_POINT	DNL	—	—	—
21	TP12,TP13	2	80_MIL_PAD	TP_80MIL	DNL	—	—	—
22	TP17,TP18	2	T POINT R	30_mil_pad	DNL	—	—	—
23	U1	1	FAN48610	FAN48610	—	FAN48610UC50X	Fairchild	IC REG BOOST SYNC 5 V 1A 9WLCSP
24	U2	1	AFE4403	AFE4403_36DSBGA	—	AFE4403YZPT	TI	IC AFE FRONT END 36DSBGA
25	U3	1	LPS25H	LPS25H_10HCLGA	—	LPS25HTR	STMicroelectronics	IC MEMS PRESSURE SENSOR 10HCLGA
26	U4	1	LSM330DLC	LSM330DLC_28LGA	—	LSM330DLCTR	STMicroelectronics	ACCELEROMETER/ GYROSCOPE 28LGA
27	U5	1	SeeedBLE	SeeedBLE	<a href="http://www.seeedstudio.com">http://www.seeedstudio.com</a>	113050012	Seeed	Low cost ARM cortex-m0 based module for Bluetooth module
28	U6	1	SFH7050	SFH7050	—	SFH7050	OSRAM	Biomonitoring Sensor for heart rate monitoring, Pulse oximetry and proximity
29	U7	1	TMP112	TMP112_SOT563	—	TMP112AIDRLT	TI	IC TEMP SENSOR DGT 5 V SOT563
30	Y1	1	8MHz	NX3225GD_8MHZ	—	NX3225GD-8MHZ-STD-CRA-3	NDK	CRYSTAL 8MHZ 8 pF SMD
31	WEARABLE SOLUTION SENSOR BOARD PCB	1	—	—	—	305-PD-15-0028	FACTRON	—

## X-ON Electronics

Largest Supplier of Electrical and Electronic Components

*Click to view similar products for [Programmable Logic IC Development Tools](#) category:*

*Click to view products by [Lattice](#) manufacturer:*

Other Similar products are found below :

[HLDC-DDR3-A](#) [DK-DEV-5SGXEA7N](#) [EK-10M50F484](#) [EPXA4F672C2](#) [EPXA4F672C3](#) [EPXA4F672C1](#) [K0161](#) [LCMXO256C-S-EVN](#)  
[12GSDIFMCCD](#) [SFP+X4FMCCD](#) [88980182](#) [P0582](#) [HW-PWAC-2600317](#) [DEV-17514](#) [LCMXO3D-9400HC-B-EVN](#) [P0671](#) [DK-K7-](#)  
[CONN-G](#) [P0467](#) [LCMXO2-1200ZE-P1-EVN](#) [LCMXO2-4000HE-DSIB-EVN](#) [DK-DEV-4SGX530N](#) [LCMXO3L-SMA-EVN](#) [P006-006-2](#)  
[EK-U1-VCU108-G](#) [A2F500-DEV-KIT-2](#) [LCMXO3LF-9400C-ASC-B-EVN](#) [471-014](#) [EVAL-TPG-ZYNQ3](#) [SL001](#) [80-001005](#) [EK-](#)  
[10CL025U256](#) [P0496](#) [P0493](#) [DK-SOC-10AS066S-A](#) [DK-DEV-10CX220-A](#) [80-001002](#) [iCE40UP5K-MDP-EVN](#) [RXCA10S066PF34-](#)  
[IDK00A](#) [ALTSODIAC5ST](#) [ALTHYDRAC5GX](#) [ALTNITROC5GX](#) [ALTBERYLLC5GX](#) [471-015](#) [LFE3-17EA-USB3-EVN](#) [1553](#) [4332](#) [Hinj](#)  
[HinjKit](#) [SNOMAKRRKIT](#) [SnoMakrR10](#)