

DETAILS

Product Number	C13936_STRADA-2X2-B2-STP
Family	Strada
Type	Lens
Color	clear
Diameter	50 x 50 mm
Height	5,18 mm
Style	square
Optic Material	PMMA
Holder Material	
Fastening	pin, screw
Status	production ready
ROHS Compliant	Yes
Date Updated	12/05/2017



OPTICAL PROPERTIES

LED	Viewing	Light	Effi-	cd/lm	Connector
	Angle	Beam	ciency		
QUICK FLUX XTP 2x4 xxx LS G5	118+45 deg	Streetligh...	94 %	0.590	-
QUICK FLUX XTP 2x6 xxx LS G5	119+45 deg	Streetligh...	94 %	0.600	-
XP-G2	119+43 deg	Streetligh...	93 %	0.580	-
XP-L HI	117+40 deg	Streetligh...	93 %	0.590	-
XP-G3	118+45 deg	Streetligh...	94 %	0.560	-
H35C1 (LEMWA33)	119+44 deg	Streetligh...	94 %	0.560	-
LUXEON TX	117+43 deg	Streetligh...	93 %	0.590	-
NVSxE21A	116+51 deg	Streetligh...	93 %	0.700	-
NVSW3x9A	119+49 deg	Streetligh...	94 %	0.530	-
PrevaLED Brick DC 2x8	118+43 deg	Streetligh...	93 %	0.580	-
Oslon Square PC	120+48 deg	Streetligh...	94 %	0.560	-
Oslon Square Gen3	118+43 deg	Streetligh...	93 %	0.580	-
OSCONIQ P 3737 (3W version)	sim: 111+45	Streetligh...	sim: 94 %	sim: 0.610	-
Fortimo FastFlex LED board 2x8 DA G4	120+44 deg	Streetligh...	94 %	0.570	-
Fortimo FastFlex LED board 2x8 DAX G4	112+64 deg	Streetligh...	94 %	sim: 0.000	-
LH351Z	118+47 deg	Streetligh...	93 %	0.560	-
LH351B	118+46 deg	Streetligh...	93 %	0.550	-
Z8Y22P	118+50 deg	Streetligh...	94 %	0.550	-
Z8Y22	116+55 deg	Streetligh...	93 %	0.570	-
TL1L4	116+45 deg	Streetligh...	88 %	0.570	-
RLE G1 49x223mm 4000lm xxx EXC OTD21	+48 deg	Streetligh...	94 %	0.580	-
RLE G1 49x245mm 4000lm xxx EXC OTD21	+48 deg	Streetligh...	94 %	0.580	-
RLE G1 49x121mm 2000lm xxx EXC OTD21	+48 deg	Streetligh...	94 %	0.580	-
RLE G1 49x133mm 2000lm xxx EXC OTD21	+48 deg	Streetligh...	94 %	0.580	-

H

G

F

E

4

3

2

1

50

45

25.4

50

12.7

12.7

$\varnothing 3.2$

Led position

Bottom view

1.5

1.1

1.2

Front view

H

G

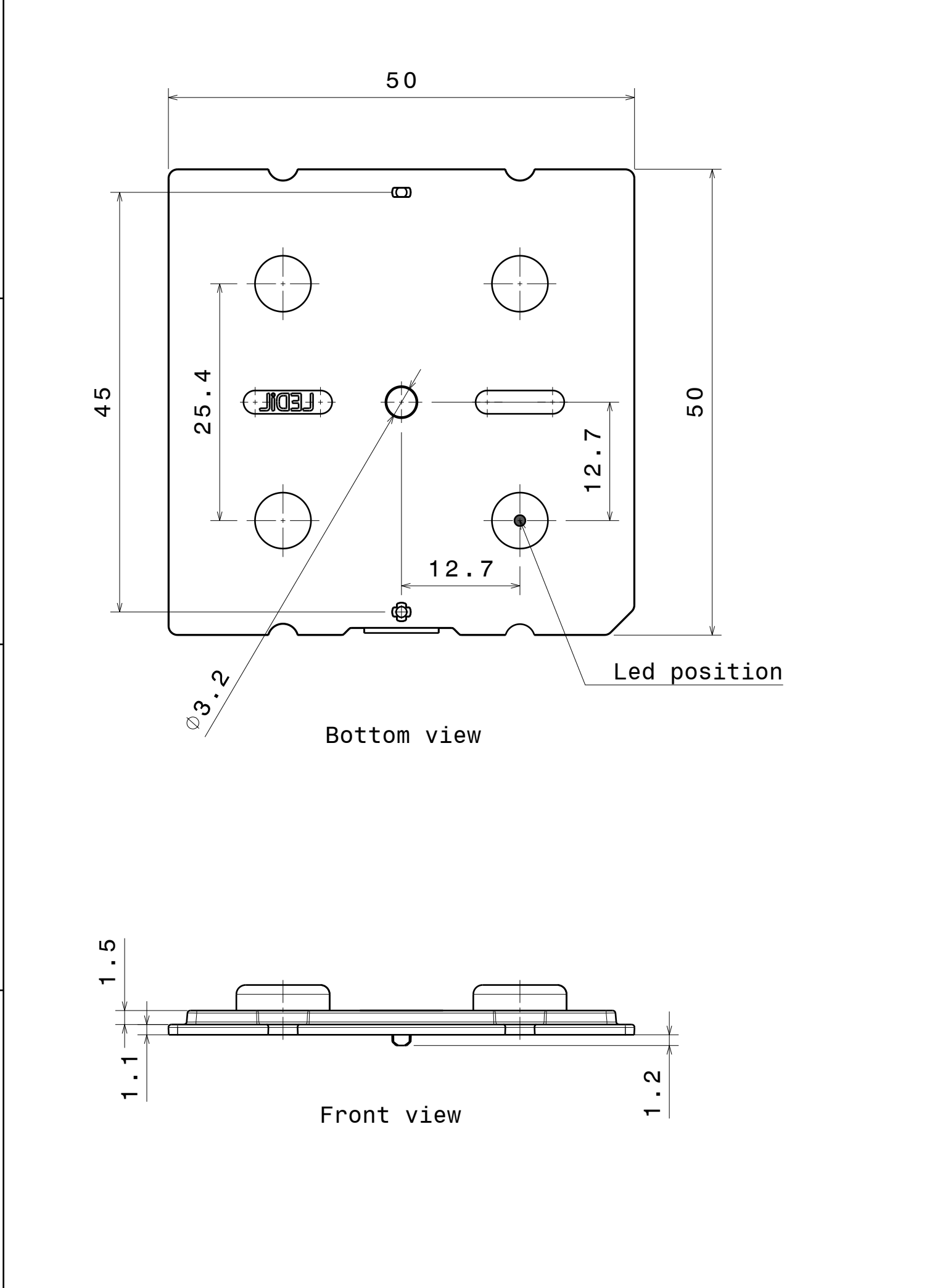

Luminaire: LEDiL Oy C13936_STRADA-2X2-B2-STP_(QUICK_FLUX_XTP_2x4_740_LS_G5)
Lamps: 1 x QUICK_FLUX_XTP_2x4_740_LS_G5_969.2lm@250mA_P=5.68795W_η=0.25A

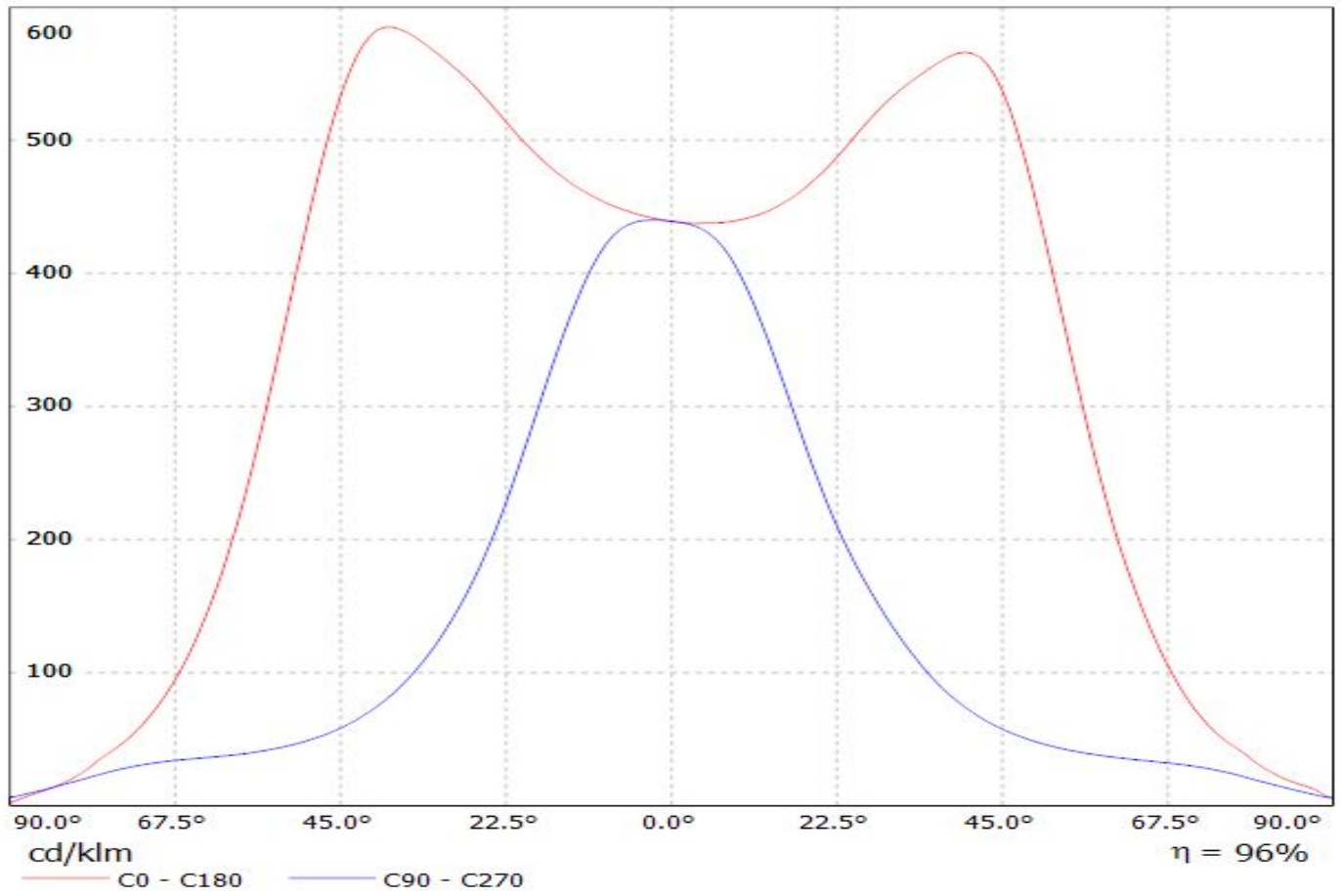

Luminaire: Ledil C13936_STRADA-2X2-B2-STP_(QUICK_FLUX_XTP_2x6_740_LS_G5)
Lamps: 1 x QUICK_FLUX_XTP_2x6_740_LS_G5_1454_29lm@250mA_P=8.60256W_I=0.25A

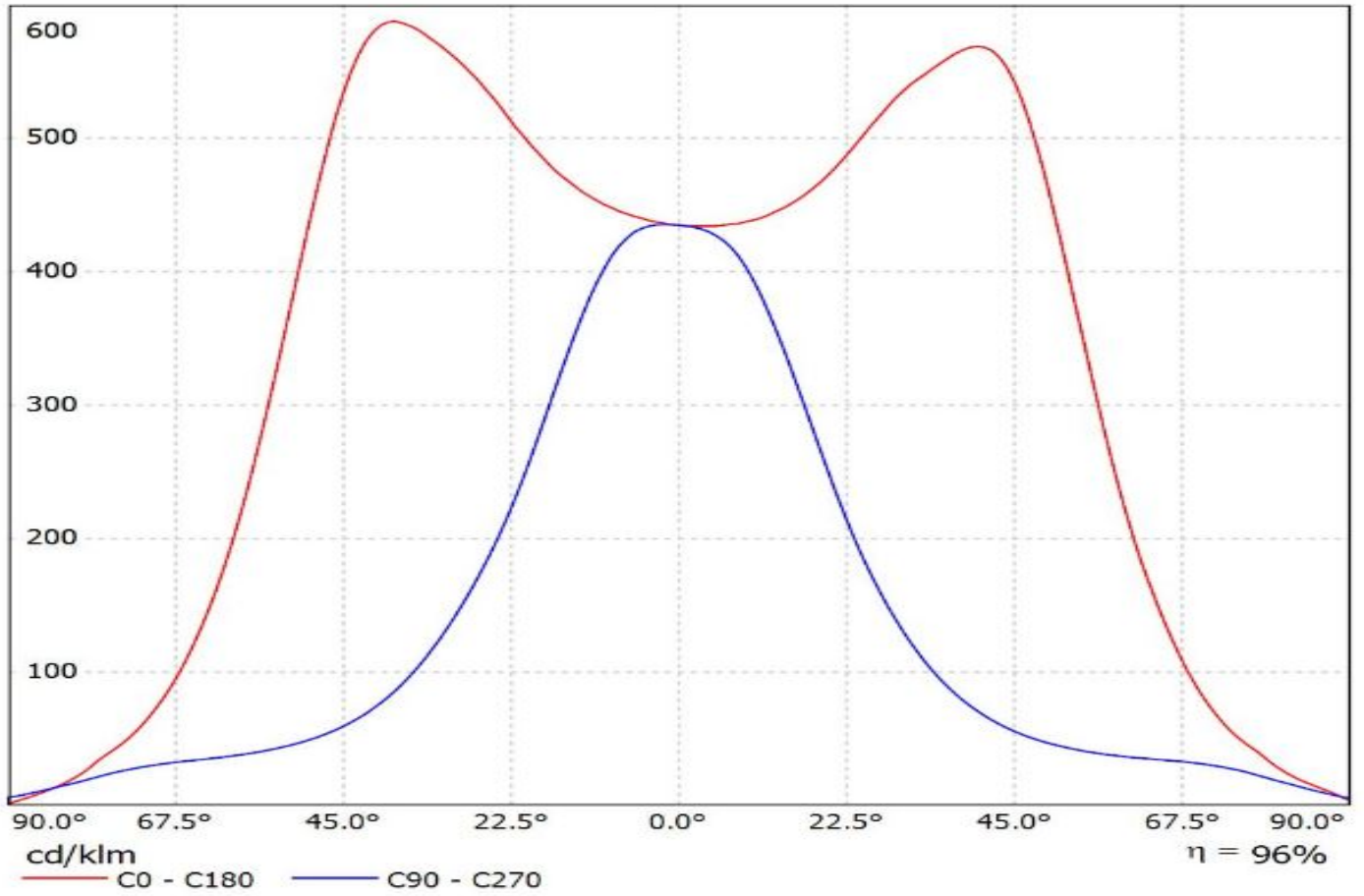

Luminaire: LEDiL Oy C13936_STRADA-2x2-B2-STP_(XP-G2)

Lamps: 1 x Cree_XP-G2_(XPGBWT-L1-000-00-G51)_411.002lm@250mA_P=2.95164W_I=0.250A

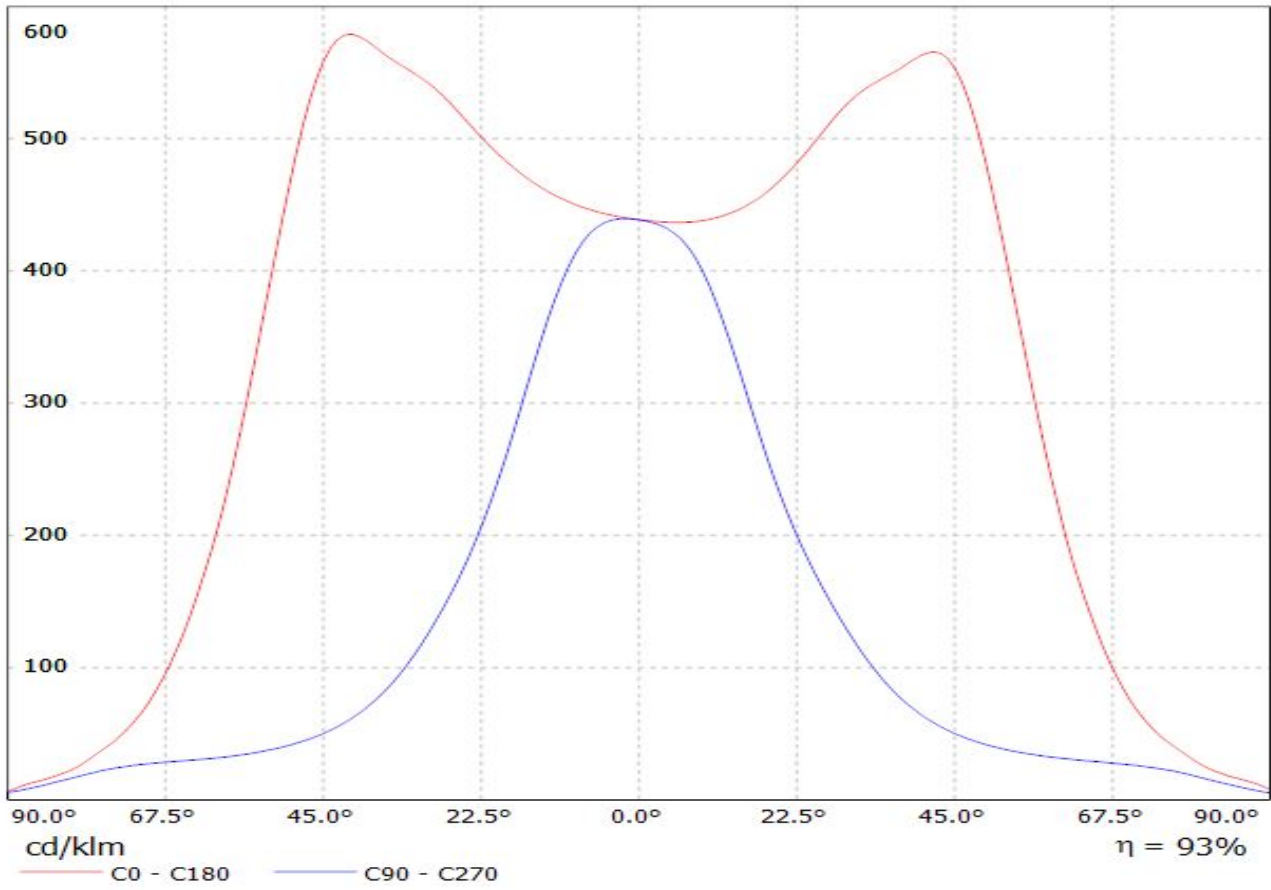

Luminaire: LEDiL Oy C13936_STRADA-2X2-B2-STP_(XP-L_HI)
Lamps: 1 x Cree_XP-L_HI_(2x2)_(XPLAWT-H-5A3-U60-013-0001)
_455.077lm@250mA_P=2.84011W_I=0,2499A

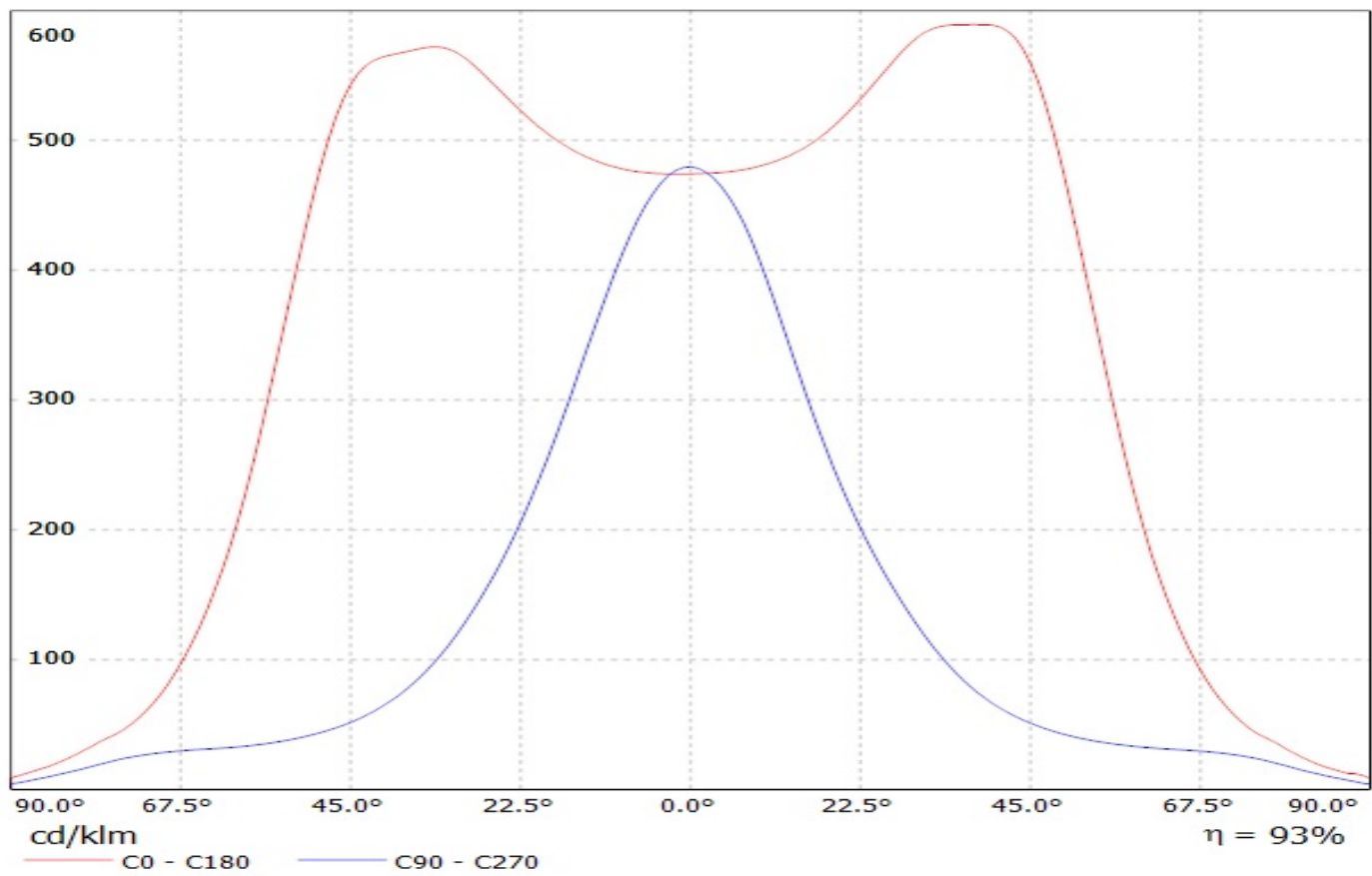

Luminaire: Ledil C13936_STRADA-2x2-B2-STP_(XP-G3)

Lamps: 1 x Cree_XP-G3_2x2_(XPGDWT-B1-3C0-S4-0-01)_516.212lm@250mA_P=2.78875W_I=0.250A

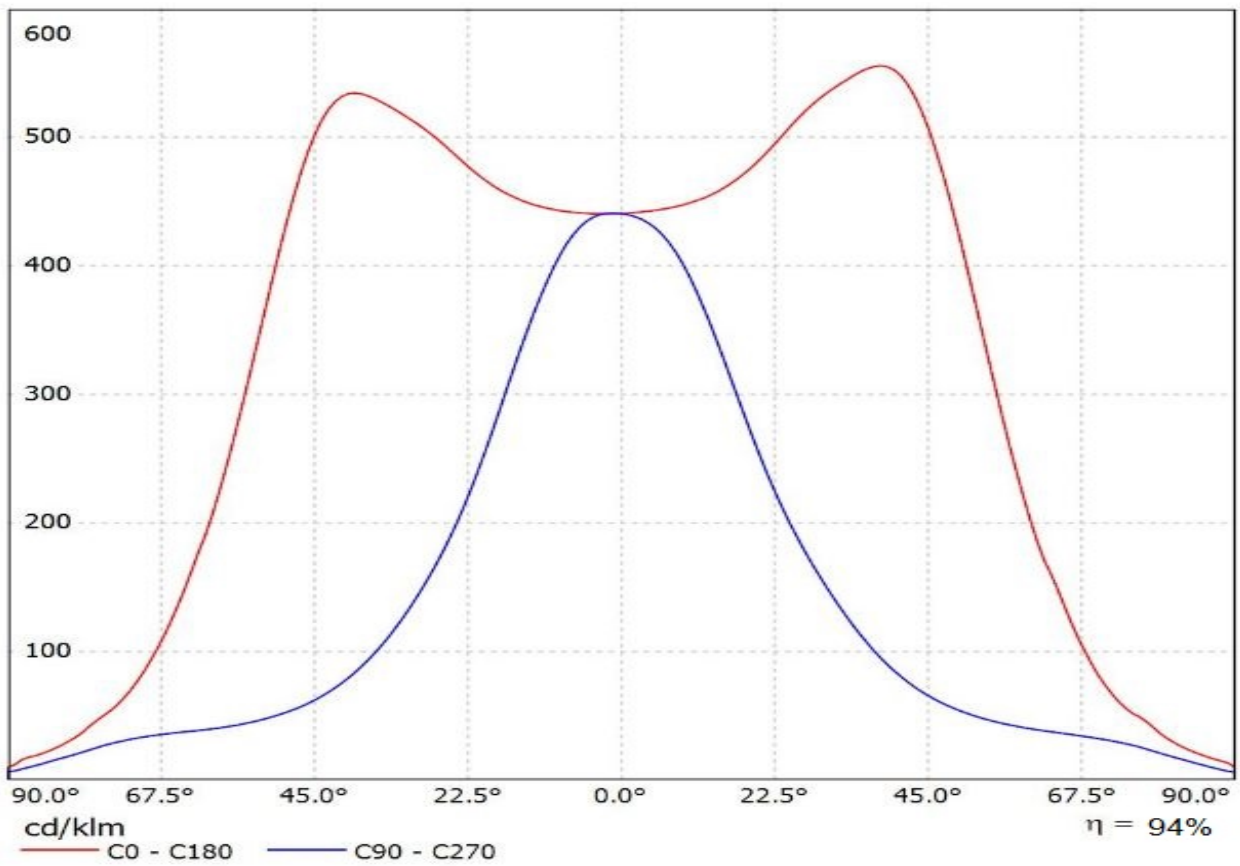

Luminaire: Ledil C13936_STRADA-2x2-B2-STP_(H35C1)
Lamps: 1 x LG_H35C1_2x2_477.216lm@250mA_P=2.87475W_I=0.250A

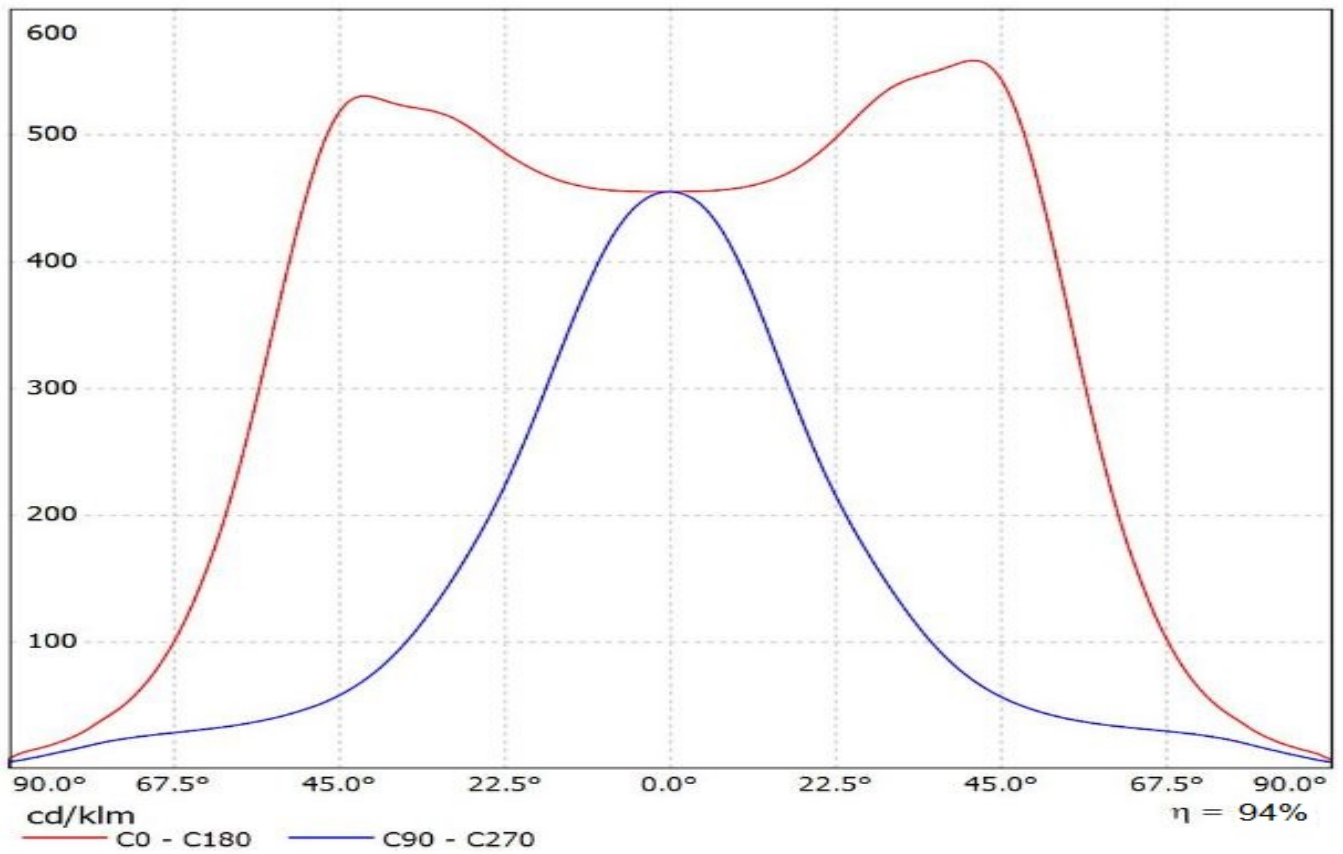

Luminaire: LEDiL Oy C13936_STRADA-2x2-B2-STP_(Luxeon_TX)
Lamps: 1 x Luxeon_TX_(L1T2-3585)_319.001lm@250mA_P=2.78902W_I=0.250A

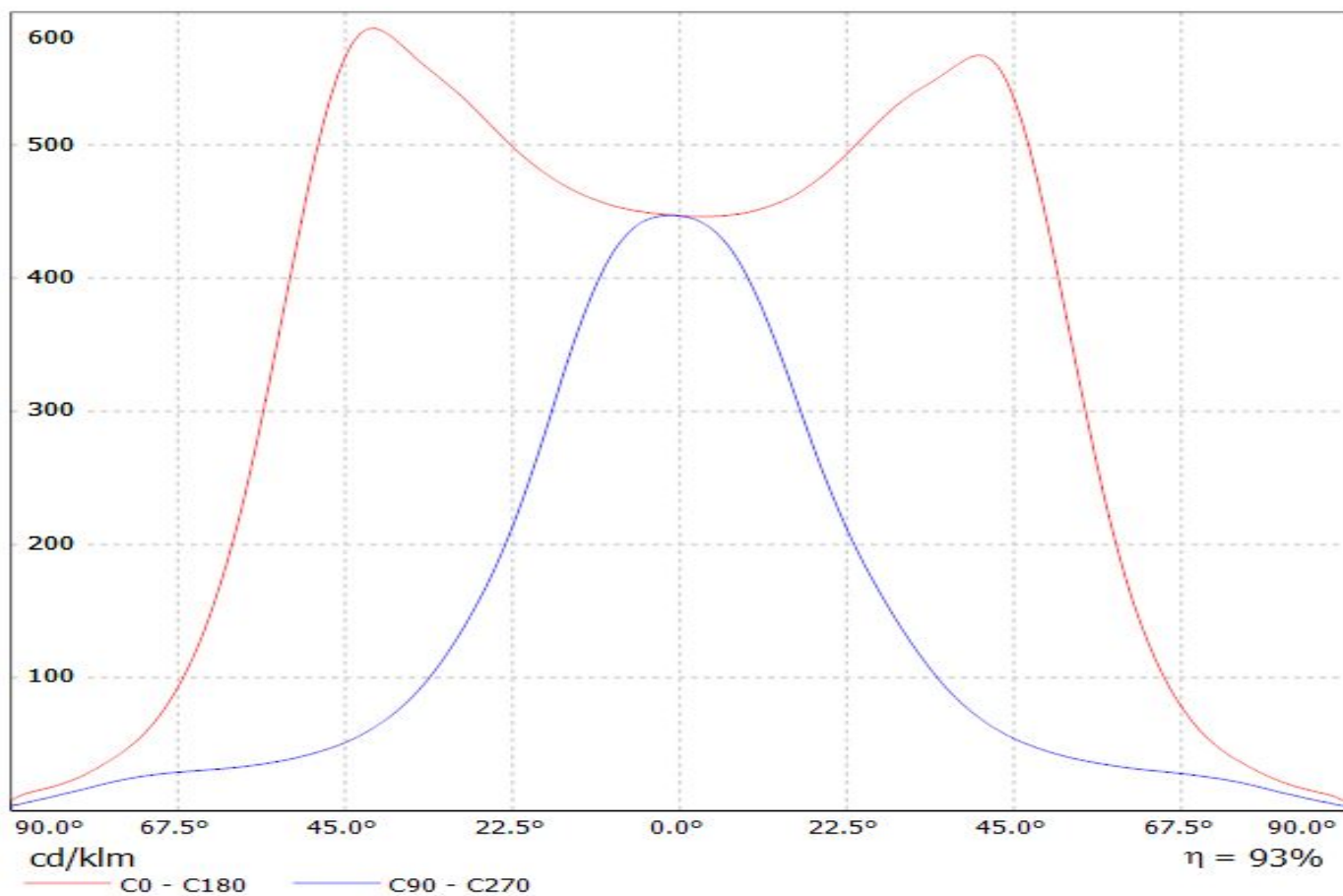

Luminaire: LEDiL Oy C13936_STRADA-2X2-B2-STP_(E21A)
Lamps: 1 x Nichia_E21A_452.248lm@250mA_2.805W_I=0.250A

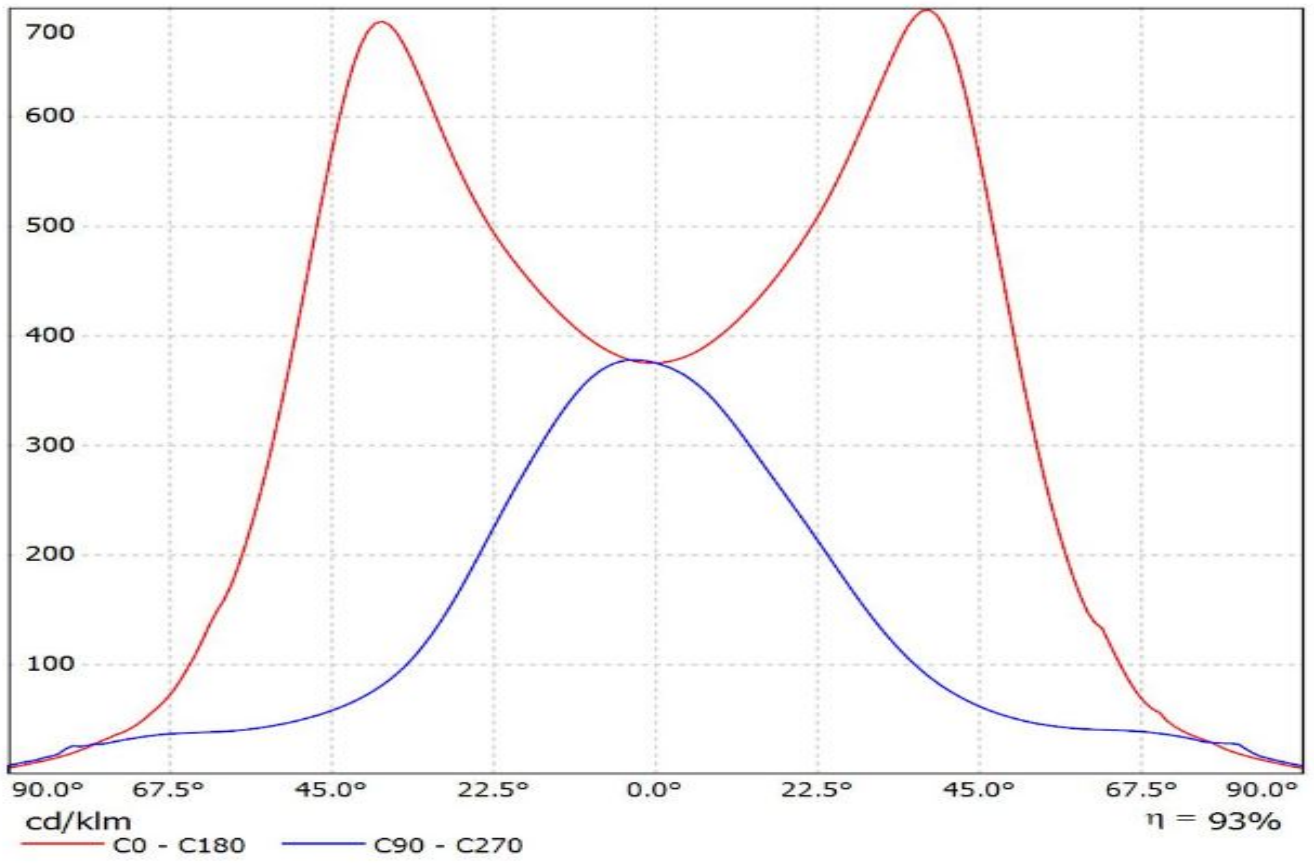

Luminaire: LEDiL Oy C13936_STRADA-2X2-B2-STP_(NVSW319AE)
Lamps: 1 x Nichia_NVSW319AE_499.093lm@250mA_P=2.79052W_I=0.25A

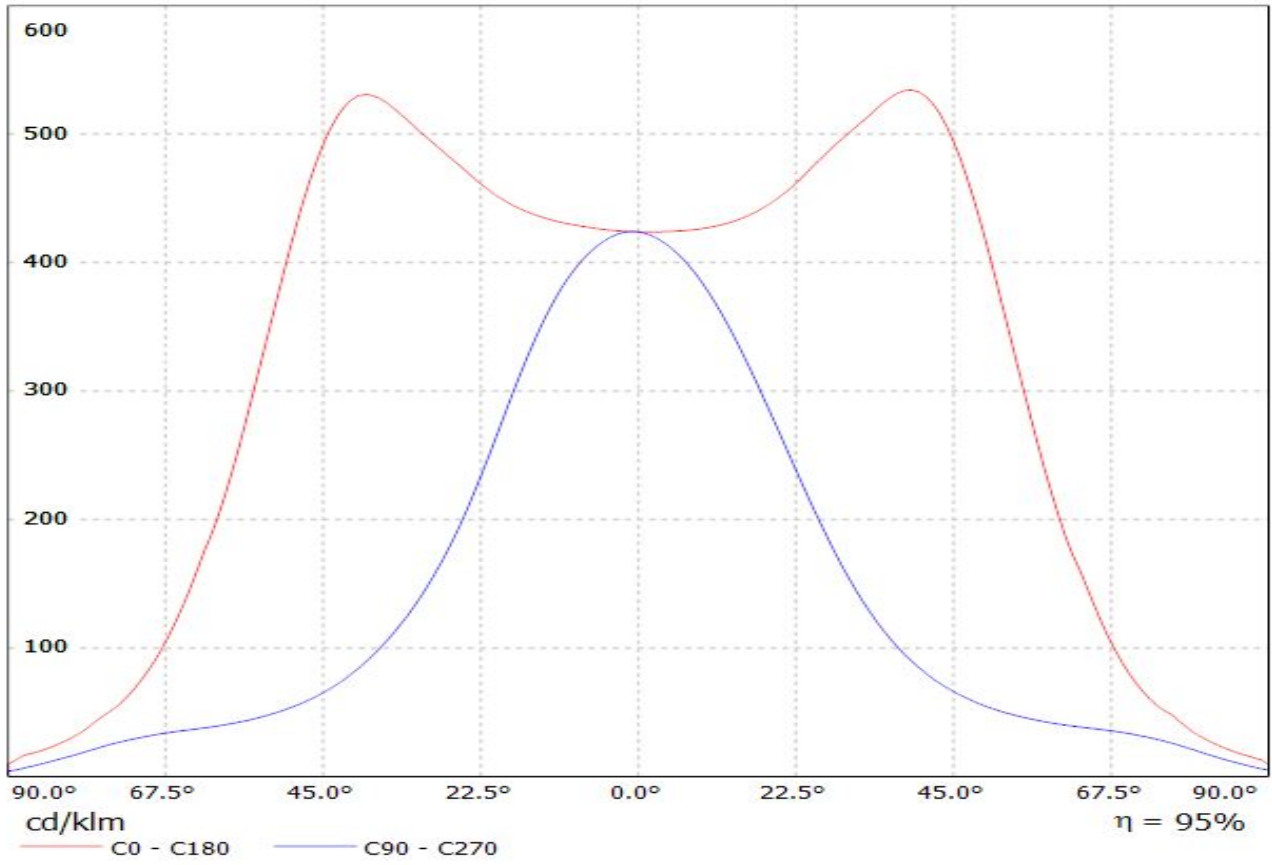

Luminaire: LEDiL Oy C13936_STRADA-2X2-B2-STP_(Oslon_Square_PC_2x2)
Lamps: 1 x Osram_Oslon_Square_PC_2x2_(GWCSSRM1.PC)
_411.322lm@250mA_P=2.85186W_I=0,2499A

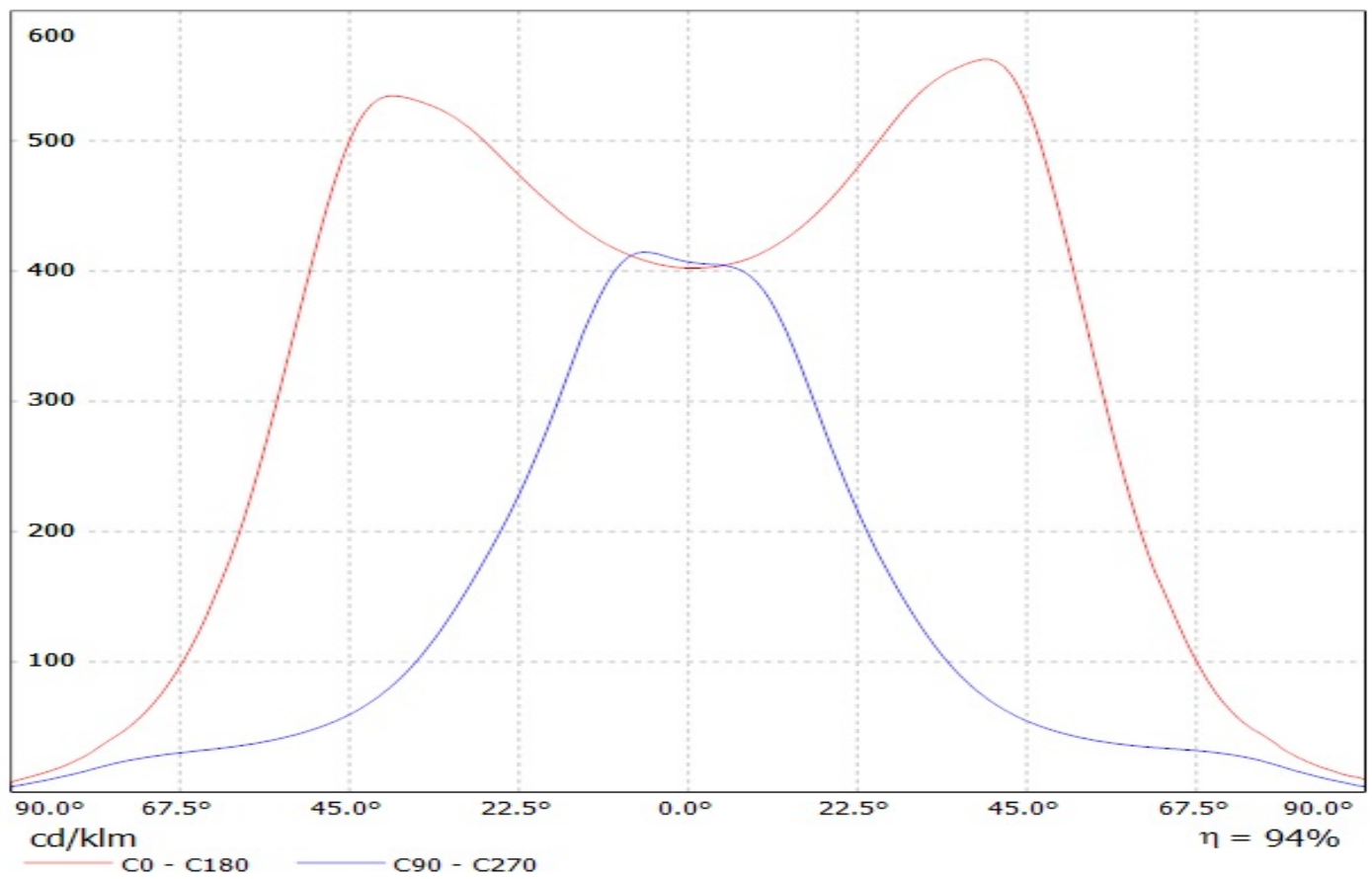

Luminaire: Ledil C13936_STRADA-2x2-B2-STP_(Square_Gen3)
Lamps: 1 x Osram_Square_Gen3_(GW_CSSRM2.PM)_461.082lm@250mA_P=2.79075W_I=0.250A

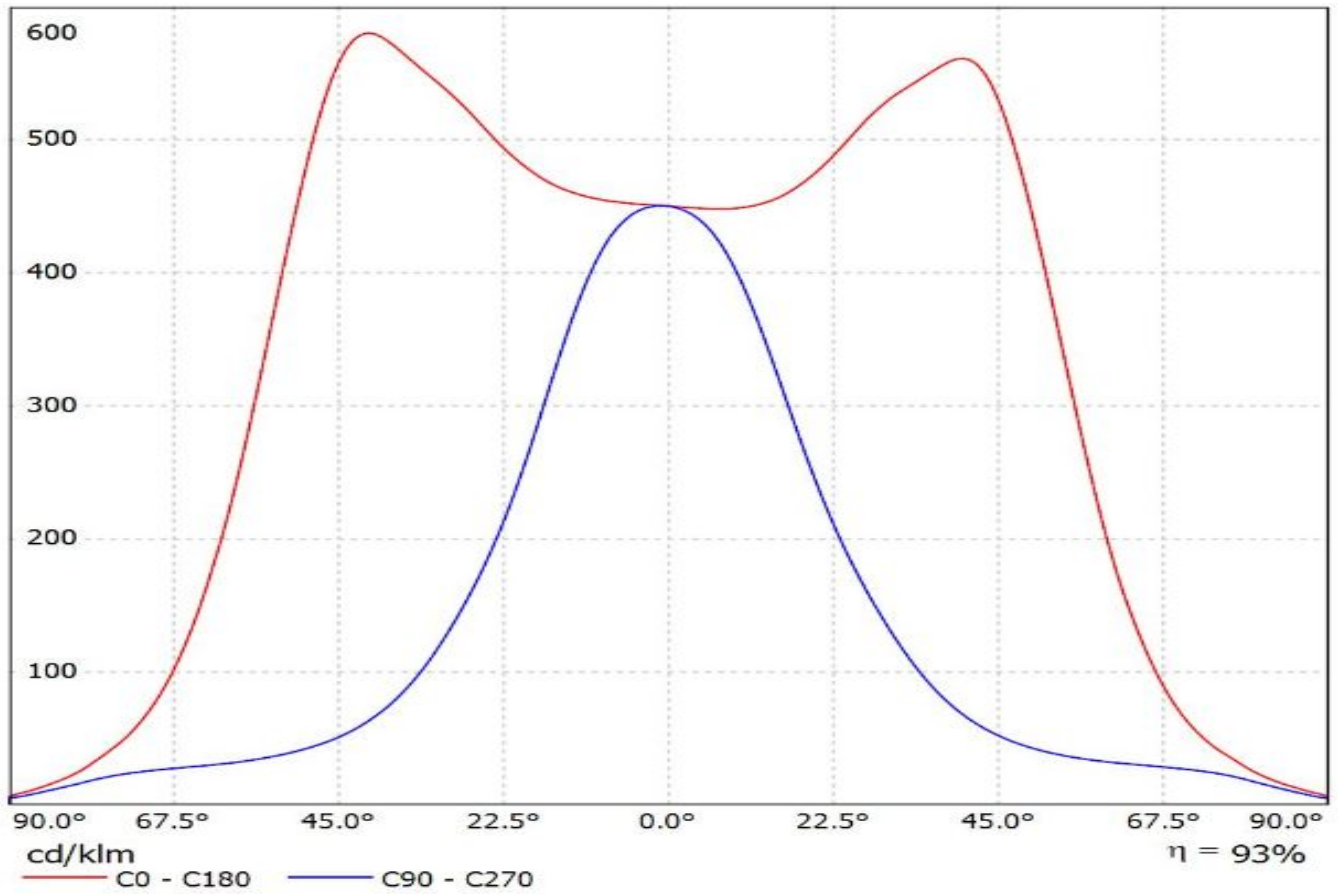

Luminaire: Ledil Oy C13936_STRADA-2X2-B2-STP_OSRAM_DURIS_P9_SIMULATED
Lamps: 1 x OSRAM DURIS P9

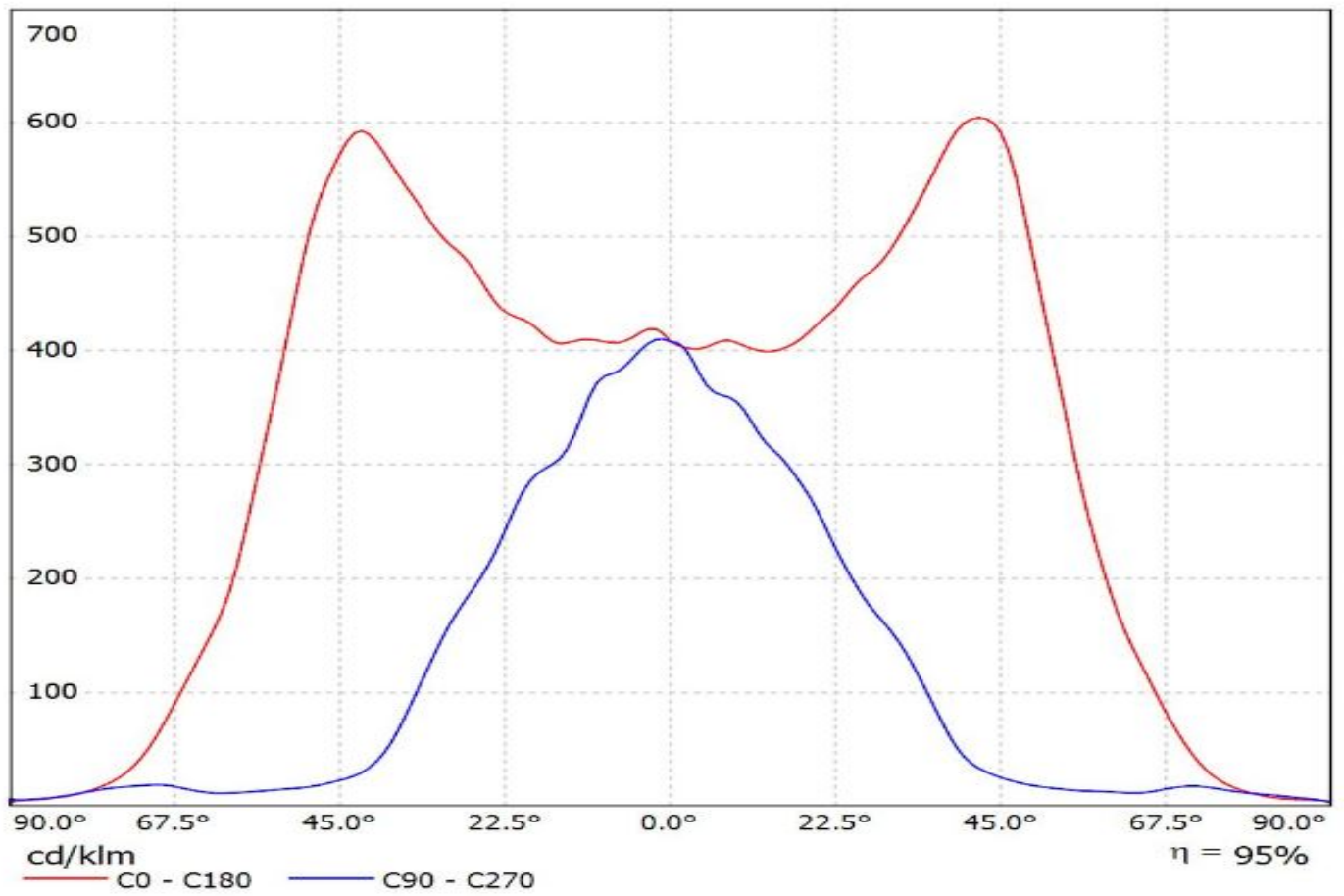

Luminaire: LEDiL Oy C13936_STRADA-2X2-B2-STP_(Fortimo_F-Flex_2x8_740DAG3)
Lamps: 1 x Philips_Fortimo_F-Flex_2x8_740DAG3_1786.86lm@250mA_P=11.6092W_I=0.2498A

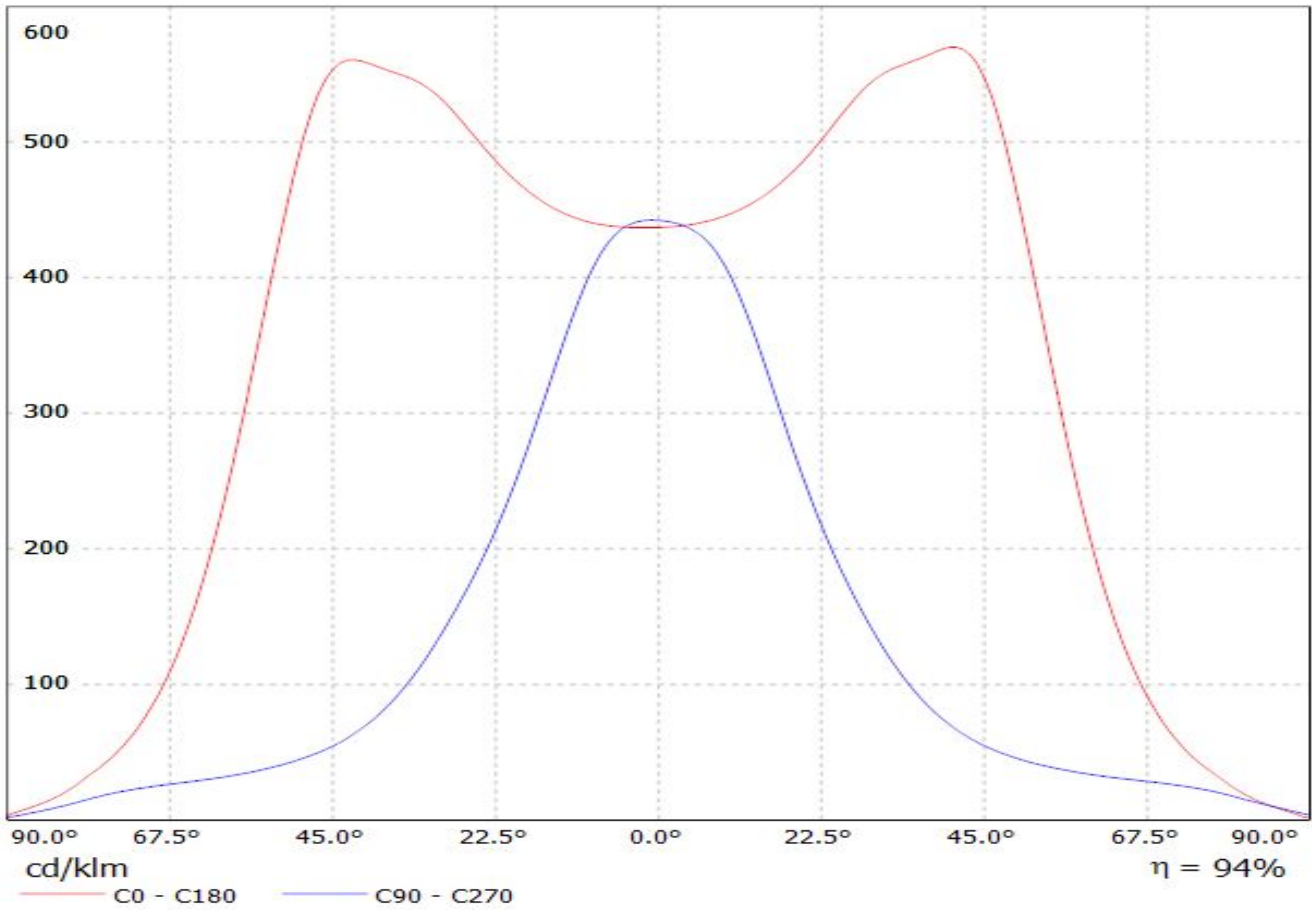

Luminaire: Ledil C13936_STRADA-2x2-B2-STP_(Fortimo FastFlex LED board 2x8 DAX G4)
Lamps: 1 x Fortimo FastFlex LED board 2x8 DAX G4

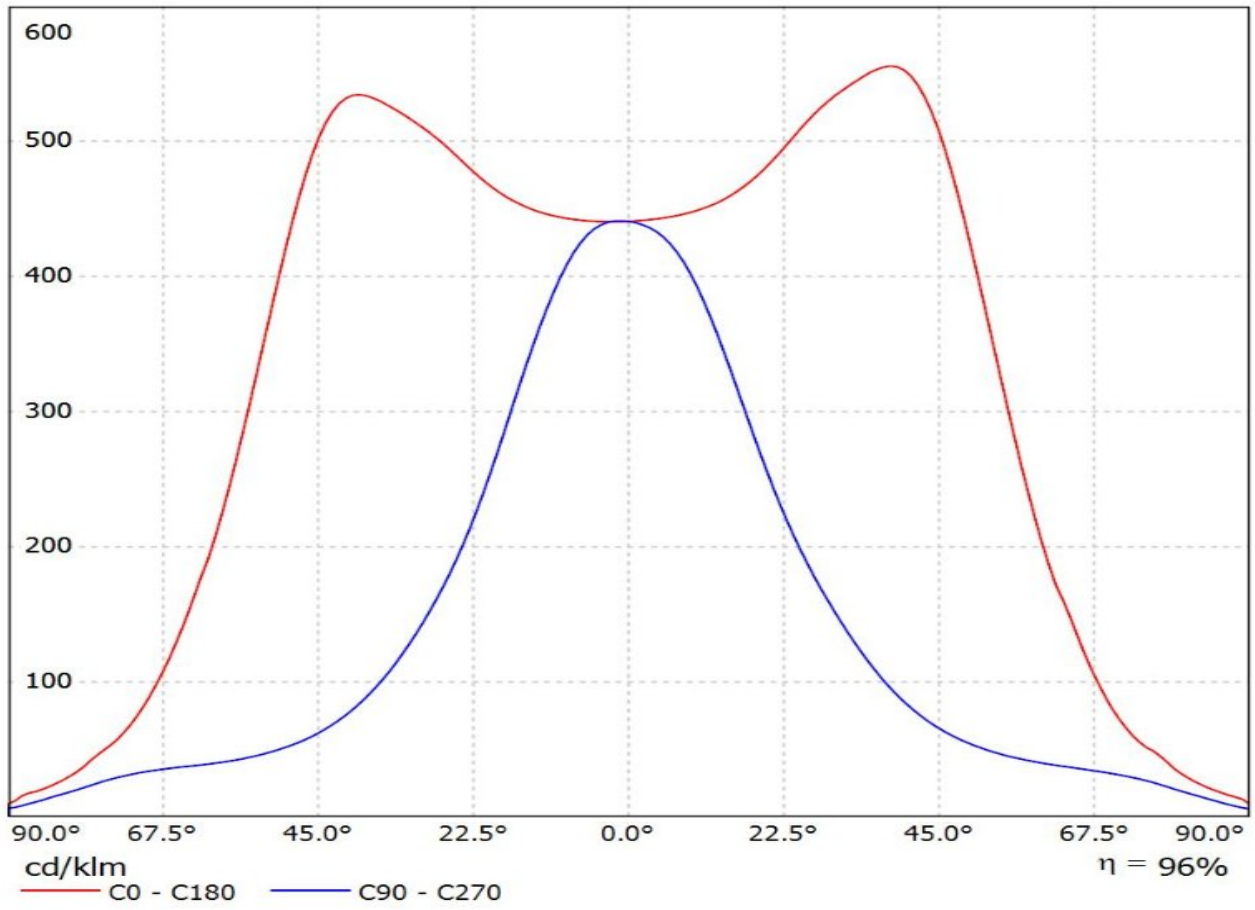

Luminaire: LEDiL Oy C13936_STRADA-2X2-B2-STP_(LH351Z) Eff.93.1%
Lamps: 1 x SAMSUNG_LH351Z_2x2_359.49lm@250mA_P=2.86371W_I=249.8mA

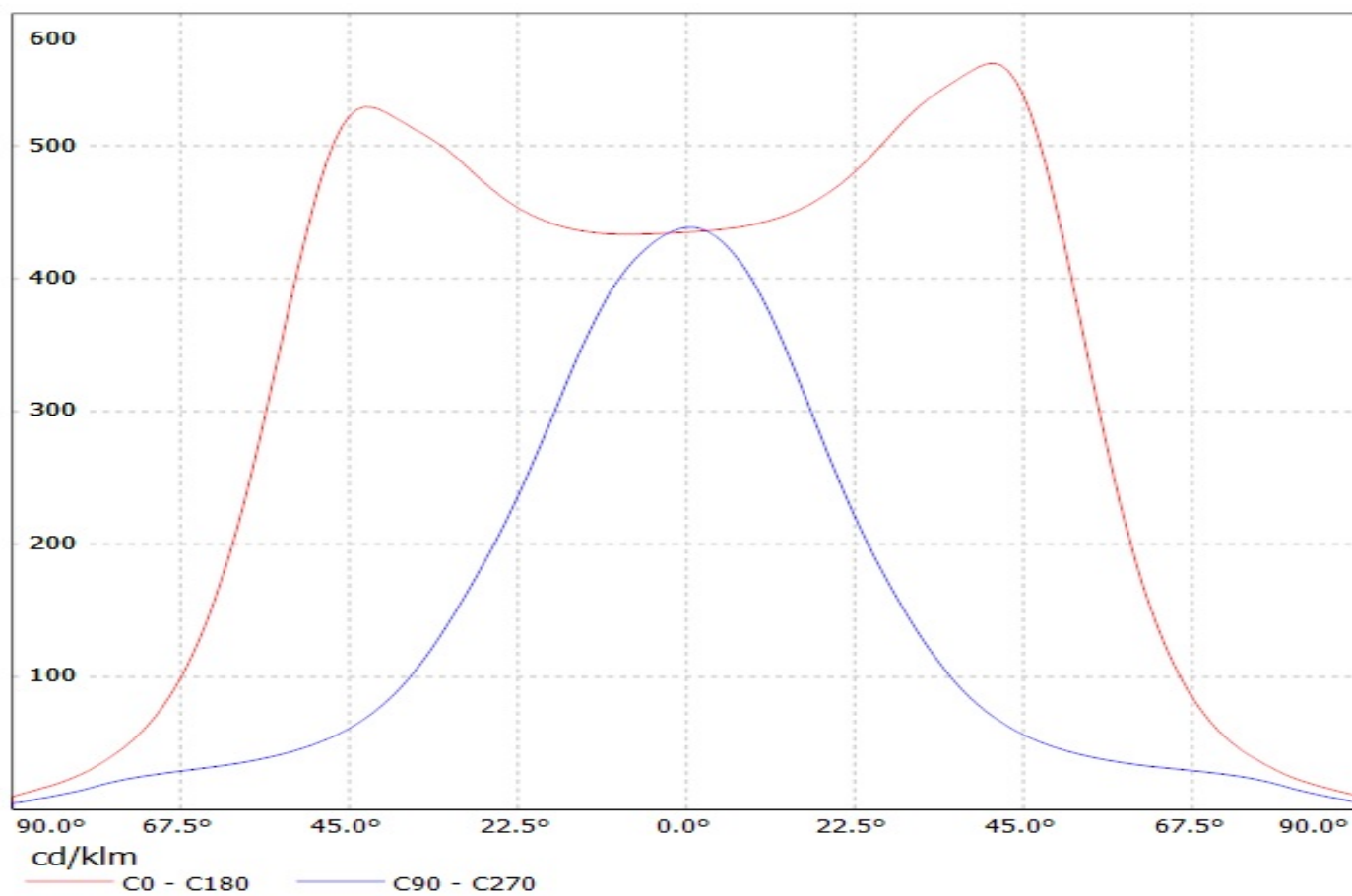

Luminaire: Ledil C13936_STRADA-2X2-B2-STP_(LH351B)

Lamps: 1 x Samsung_LH351B_2x2_444.178lm@250mA_P=2.8535W_I=0.25A

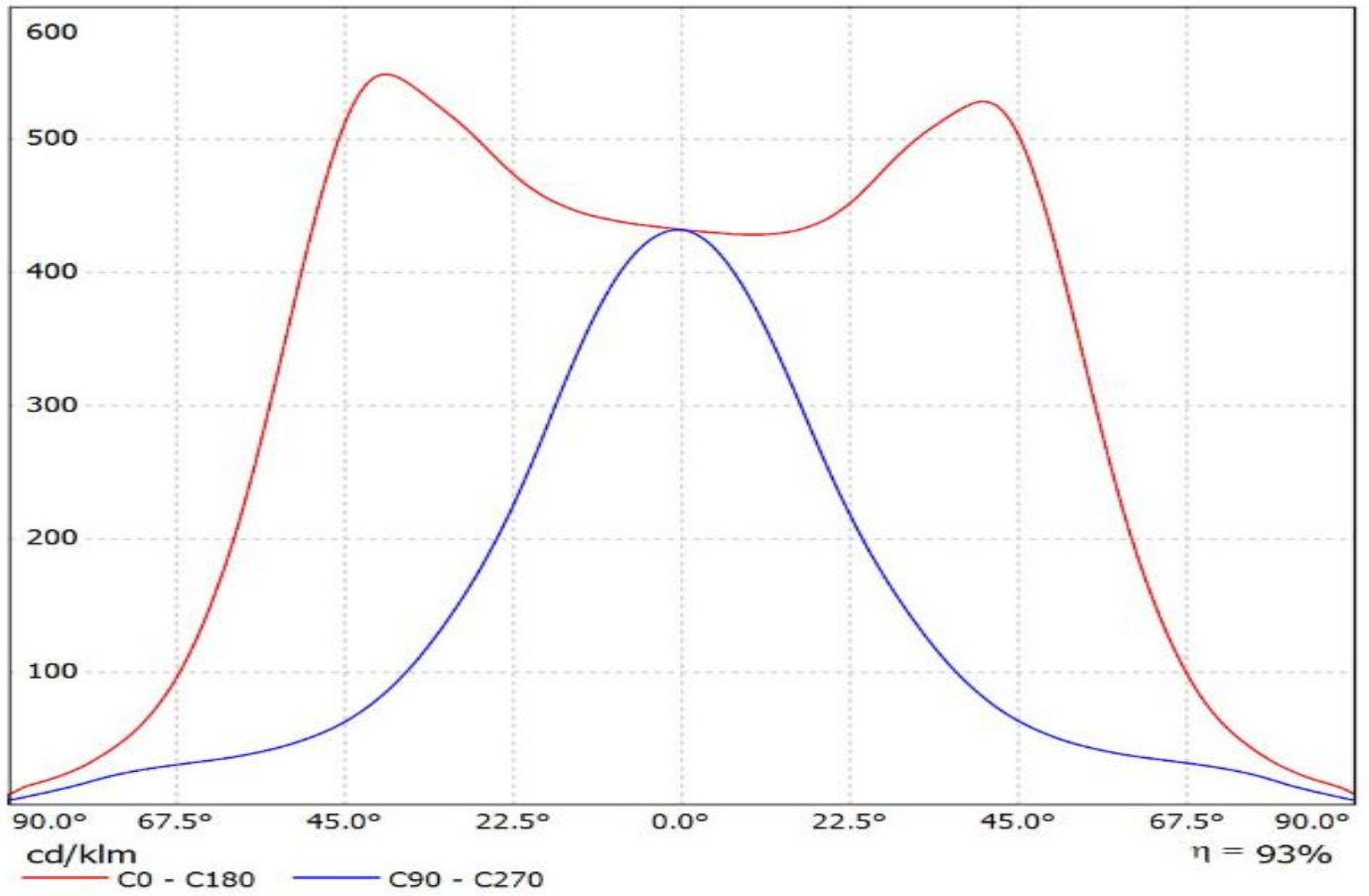

Luminaire: LEDiL Oy C13936_STRADA-2X2-B2-STP_(Z8Y22+)

Lamps: 1 x Seoul_Z8Y22+_(W6E2G)_498.702lm@250mA_P=2.72132W_I=0.250A

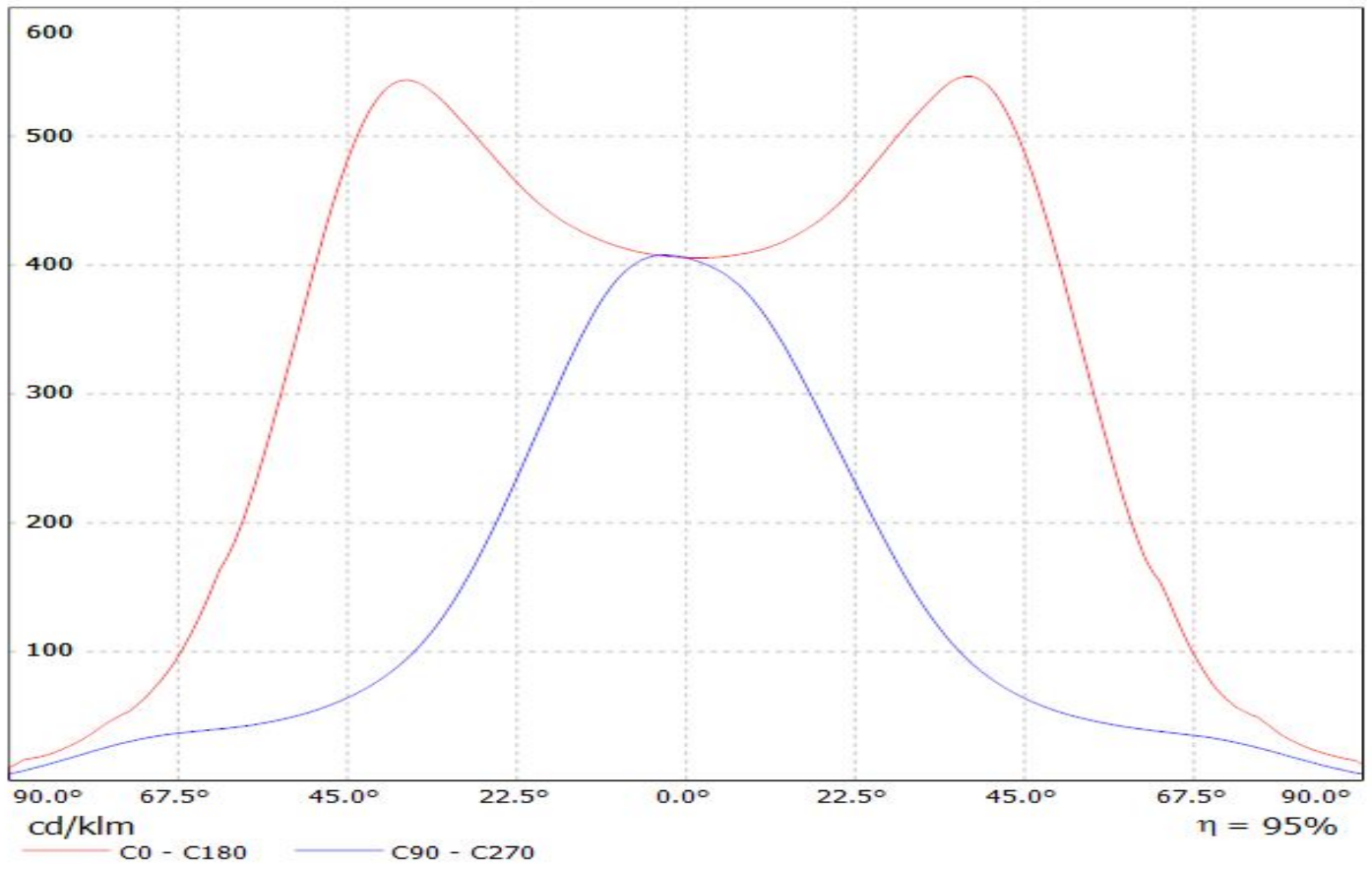

Luminaire: LEDiL Oy C13936_STRADA-2X2-B2-STP_(Z8Y22)
Lamps: 1 x Seoul_Wicop_Z8Y22_497.833lm@250mA_P=2.79801W_U=11.199V

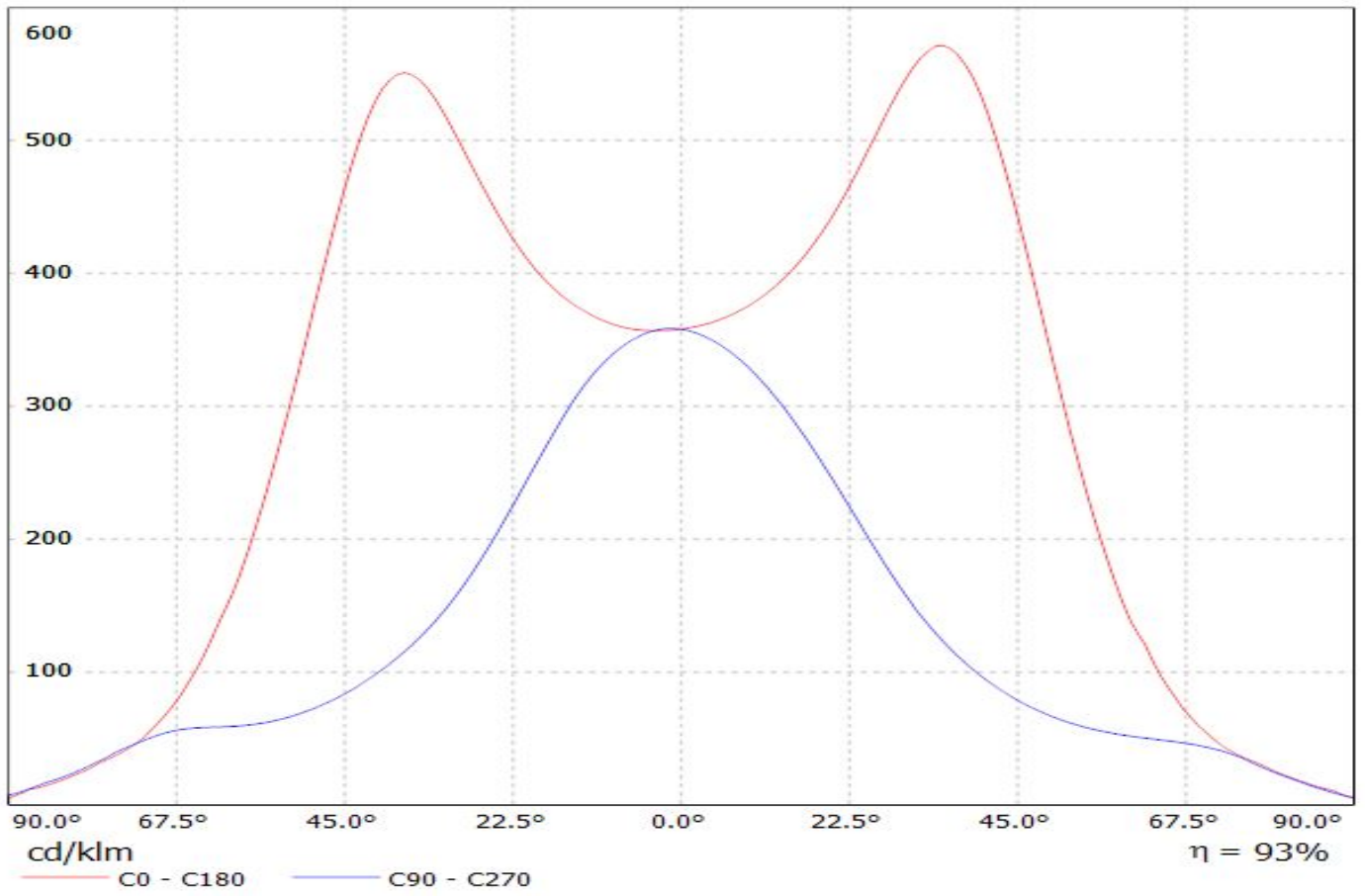

Ledil C13936_STRADA-2X2-B2-STP_(TL1L4) / LDC (Linear)

Luminaire: Ledil C13936_STRADA-2X2-B2-STP_(TL1L4)

Lamps: 1 x Toshiba_TL1L4_2x2_(TL1L4-DW0)_472.639lm@250mA_CCT=6500K_P=2.9W_I=0.25A

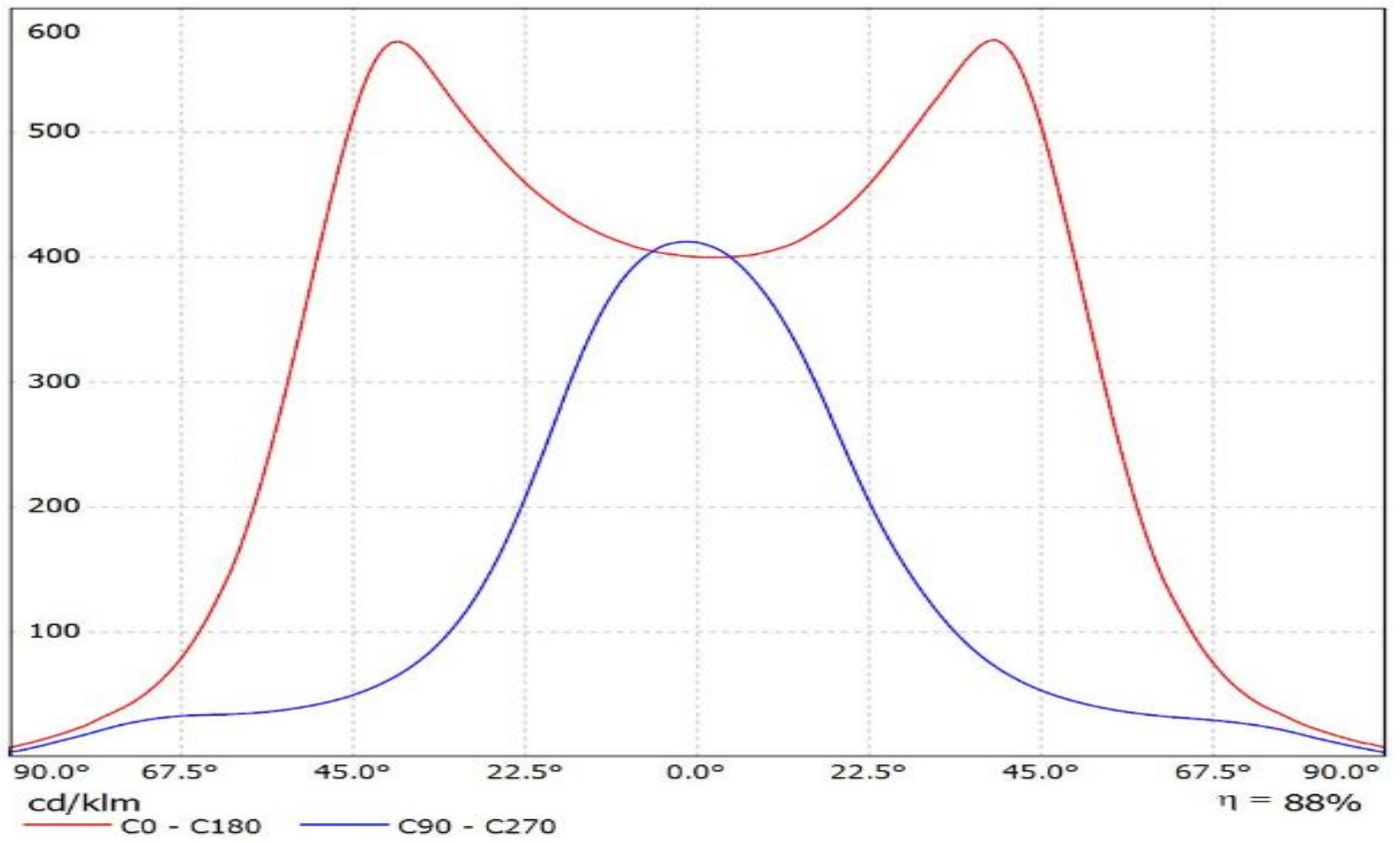

Luminaire: LEDiL Oy C13936_STRADA-2X2-B2-STP_(Tridonic_Module_RLE_G1)
Lamps: 1 x Tridonic_Module_RLE_G1_4576.03lm@700mA_P=32.0681W_I=0.700A

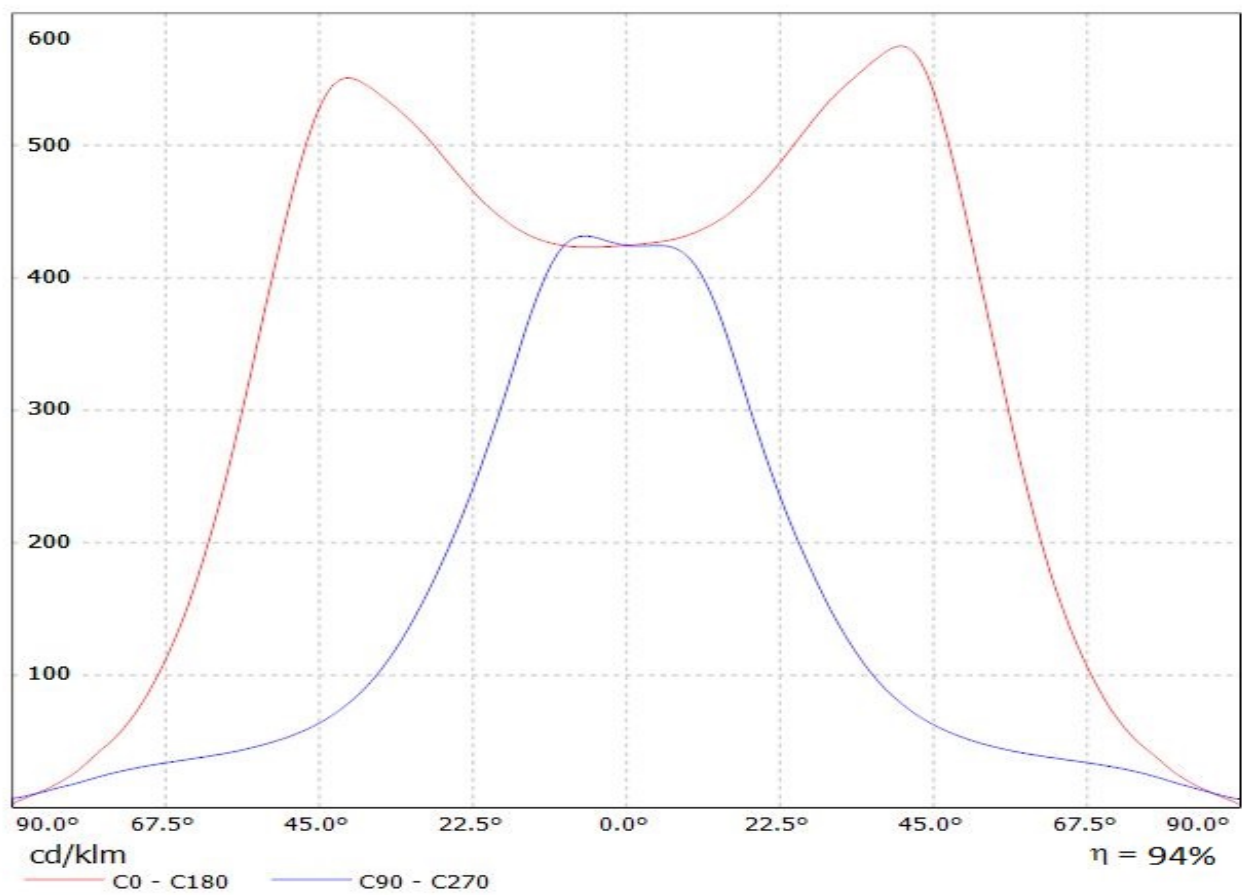

Luminaire: LEDiL Oy C13936_STRADA-2X2-B2-STP_(Tridonic_Module_RLE_G1)
Lamps: 1 x Tridonic_Module_RLE_G1_4576.03lm@700mA_P=32.0681W_I=0.700A

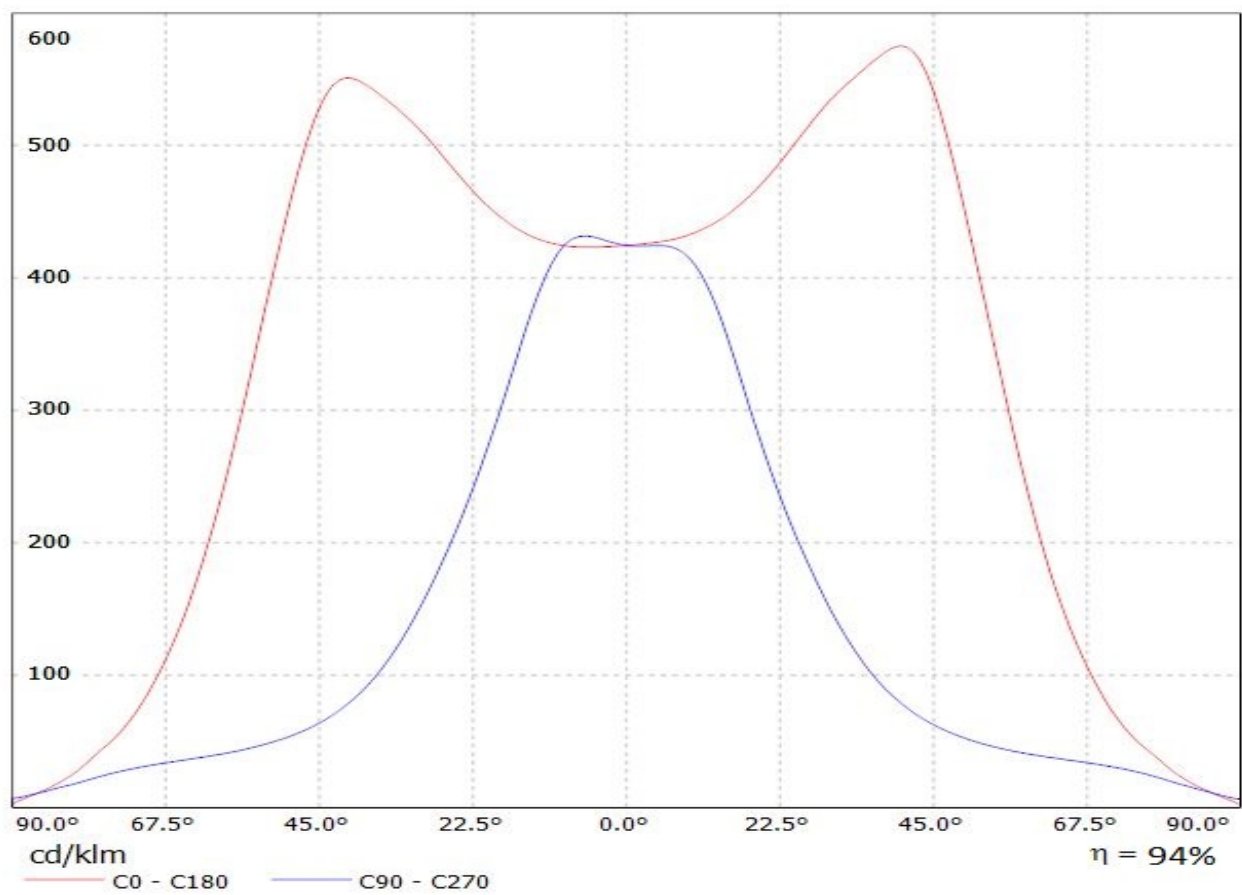

Luminaire: LEDiL Oy C13936_STRADA-2X2-B2-STP_(Tridonic_Module_RLE_G1)
Lamps: 1 x Tridonic_Module_RLE_G1_2288lm@700mA_P=16W_I=0.700A

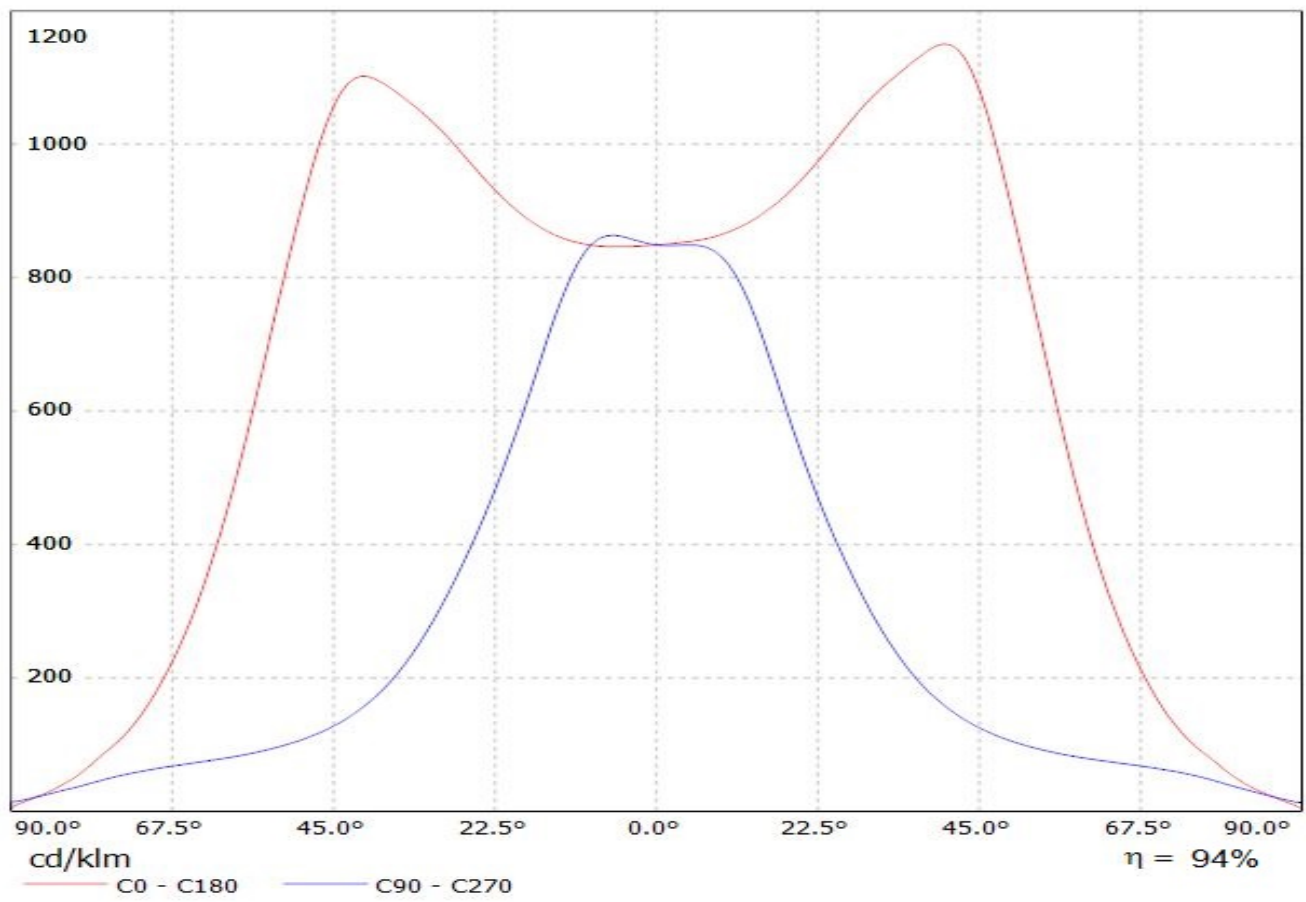

Luminaire: LEDiL Oy C13936_STRADA-2X2-B2-STP_(Tridonic_Module_RLE_G1)
Lamps: 1 x Tridonic_Module_RLE_G1_2288lm@700mA_P=16W_I=0.700A

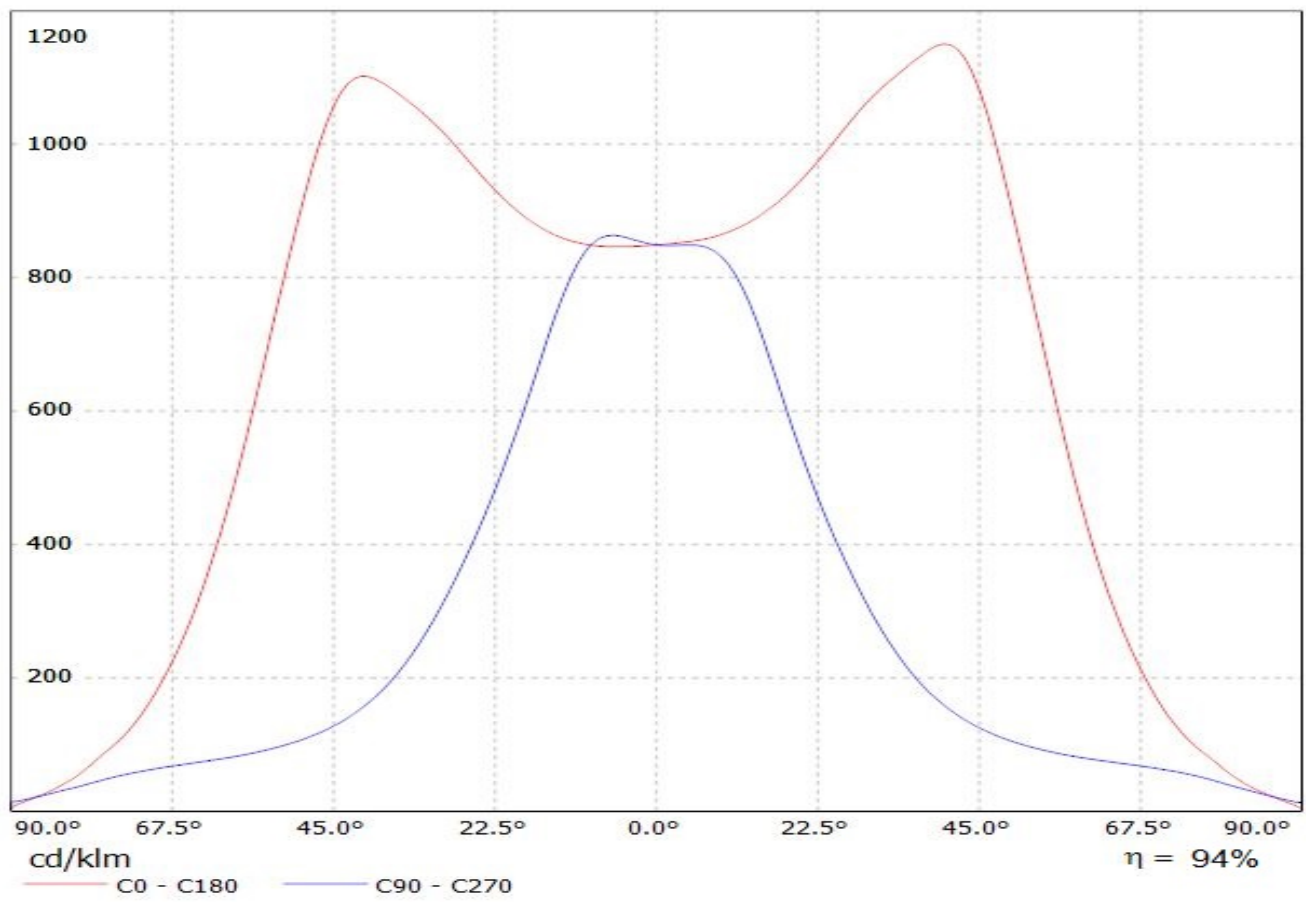

Luminaire: LEDiL Oy C13936_STRADA-2X2-B2-STP_(QUICK_FLUX_XTP_2x4_740_LS_G5)
Lamps: 1 x QUICK_FLUX_XTP_2x4_740_LS_G5_969.2lm@250mA_P=5.68795W_η=0.25A

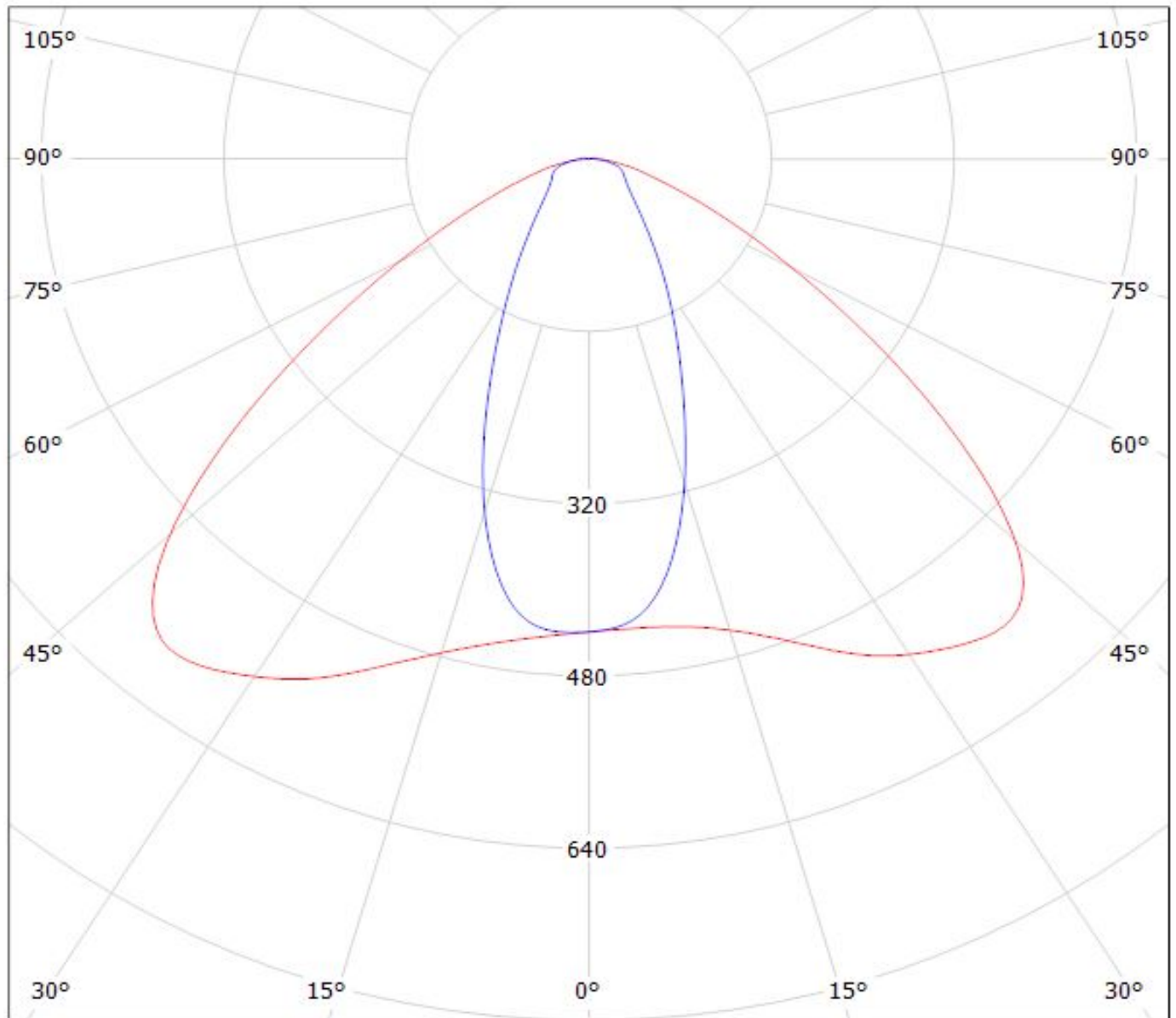

cd/klm

$\eta = 96\%$

— C0 - C180 — C90 - C270

Luminaire: Ledil C13936_STRADA-2X2-B2-STP_(QUICK_FLUX_XTP_2x6_740_LS_G5)
Lamps: 1 x QUICK_FLUX_XTP_2x6_740_LS_G5_1454.29lm@250mA_P=8.60256W_I=0.25A

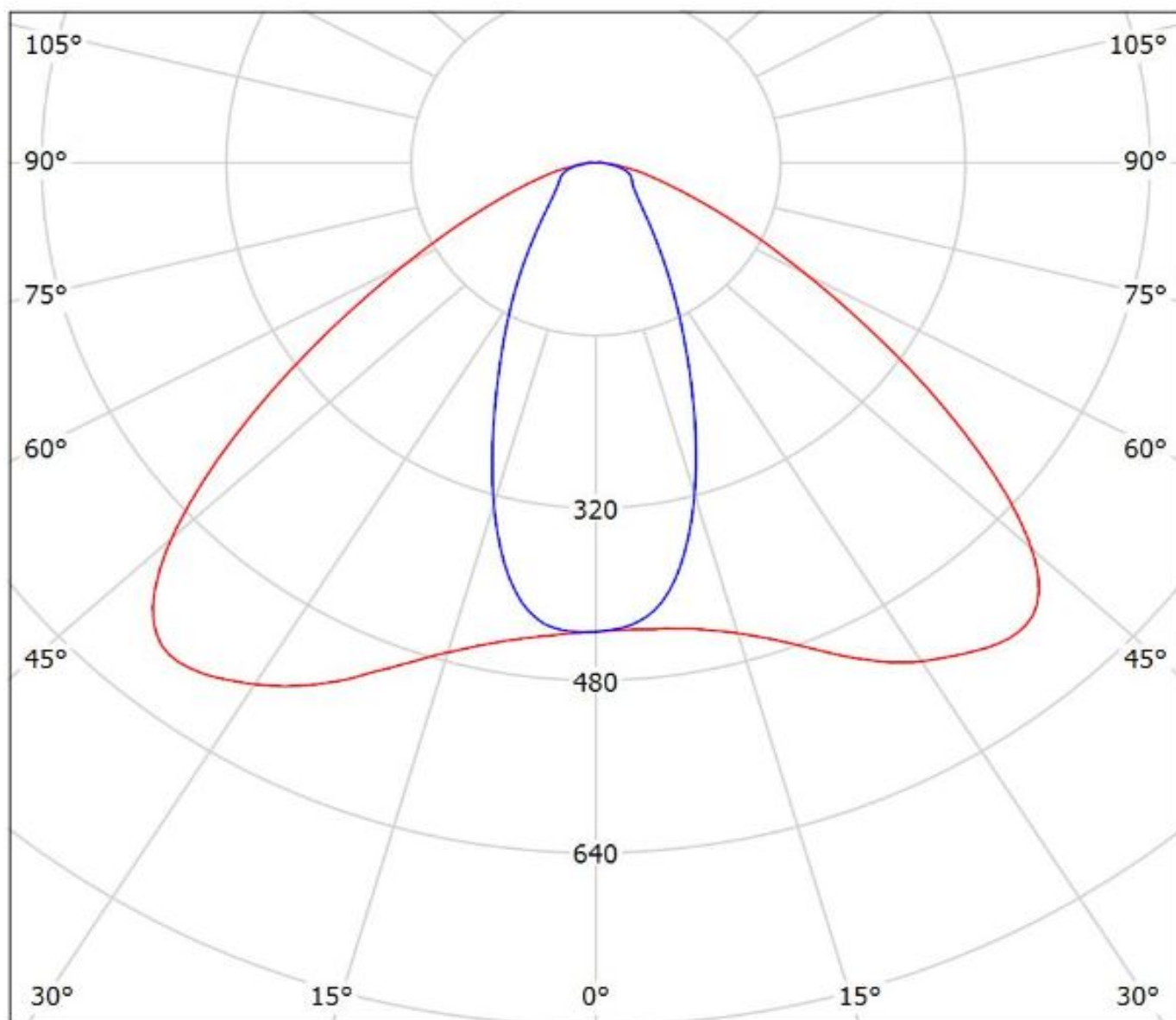

cd/klm
— C0 - C180 — C90 - C270

$\eta = 96\%$

Luminaire: LEDiL Oy C13936_STRADA-2x2-B2-STP_(XP-G2)

Lamps: 1 x Cree_XP-G2_(XPGBWT-L1-000-00-G51)_411.002lm@250mA_P=2.95164W_I=0.250A

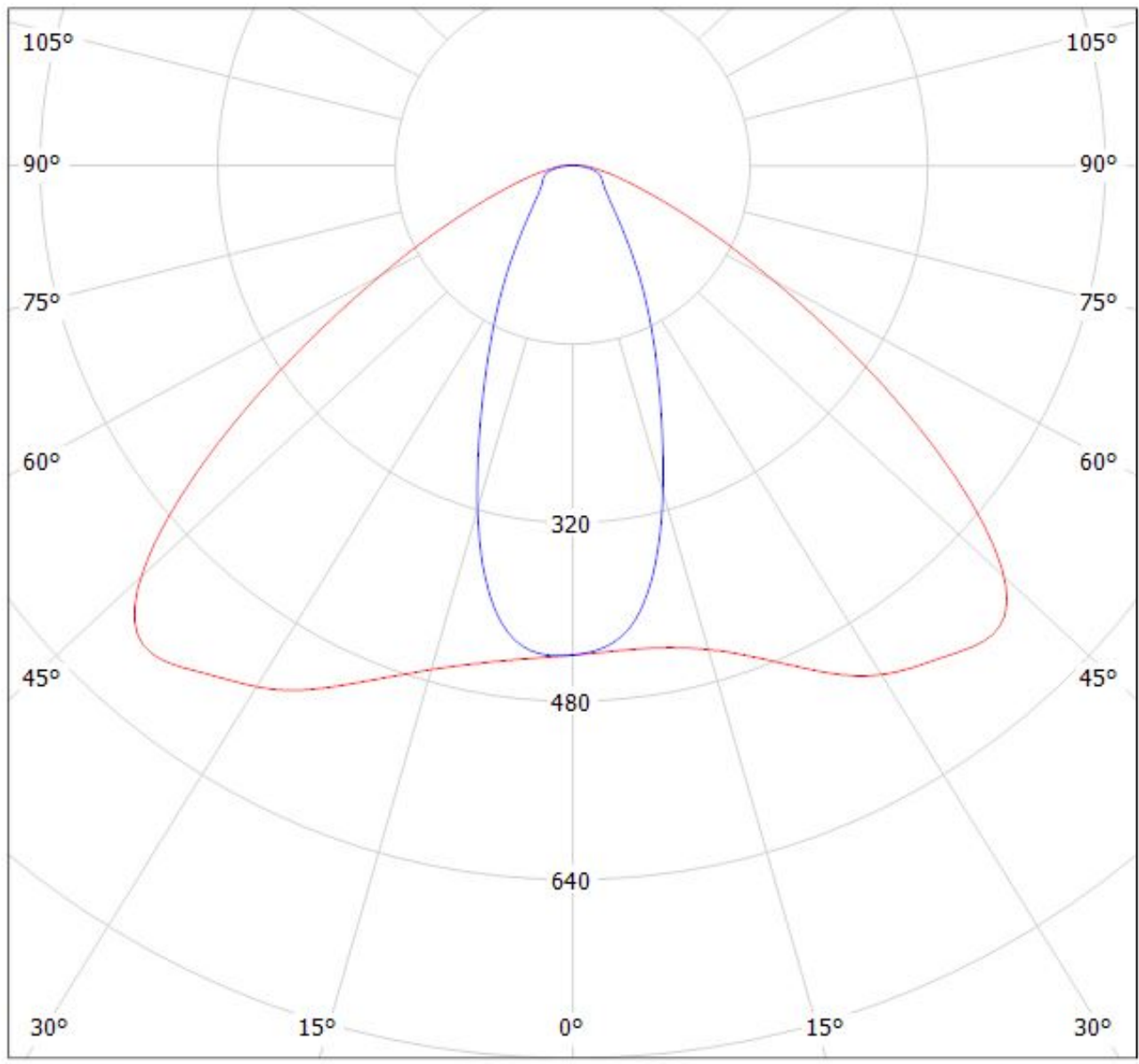

cd/klm

— C0 - C180 — C90 - C270

$\eta = 93\%$

Luminaire: LEDiL Oy C13936_STRADA-2X2-B2-STP_(XP-L_HI)
Lamps: 1 x Cree_XP-L_HI_(2x2)_(XPLAWT-H-5A3-U60-013-0001)
_455.077lm@250mA_P=2.84011W_I=0,2499A

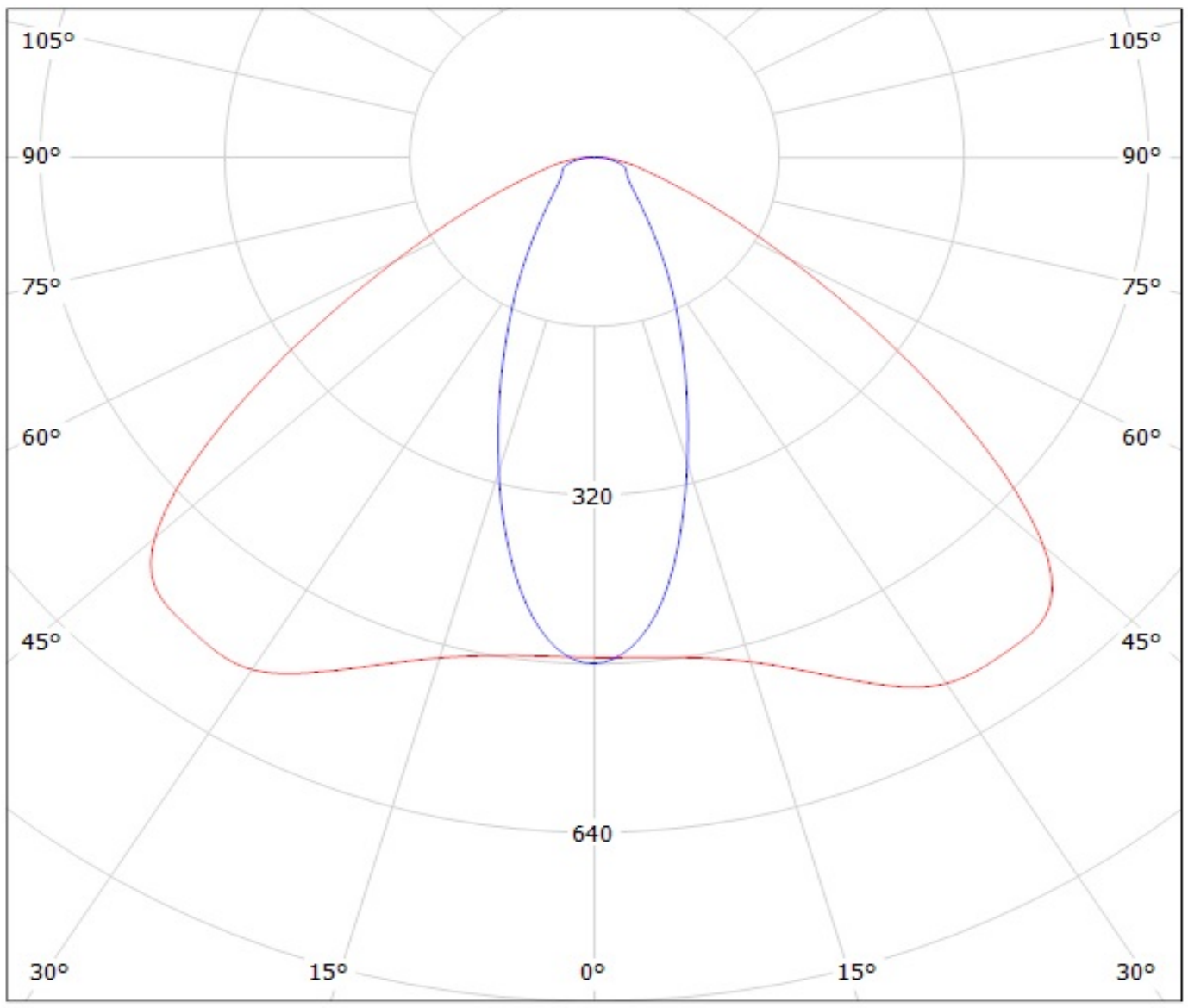

cd/klm

— C0 - C180 — C90 - C270

$\eta = 93\%$

Luminaire: Ledil C13936_STRADA-2x2-B2-STP_(XP-G3)

Lamps: 1 x Cree_XP-G3_2x2_(XPGDWT-B1-3C0-S4-0-01)_516.212lm@250mA_P=2.78875W_I=0.250A

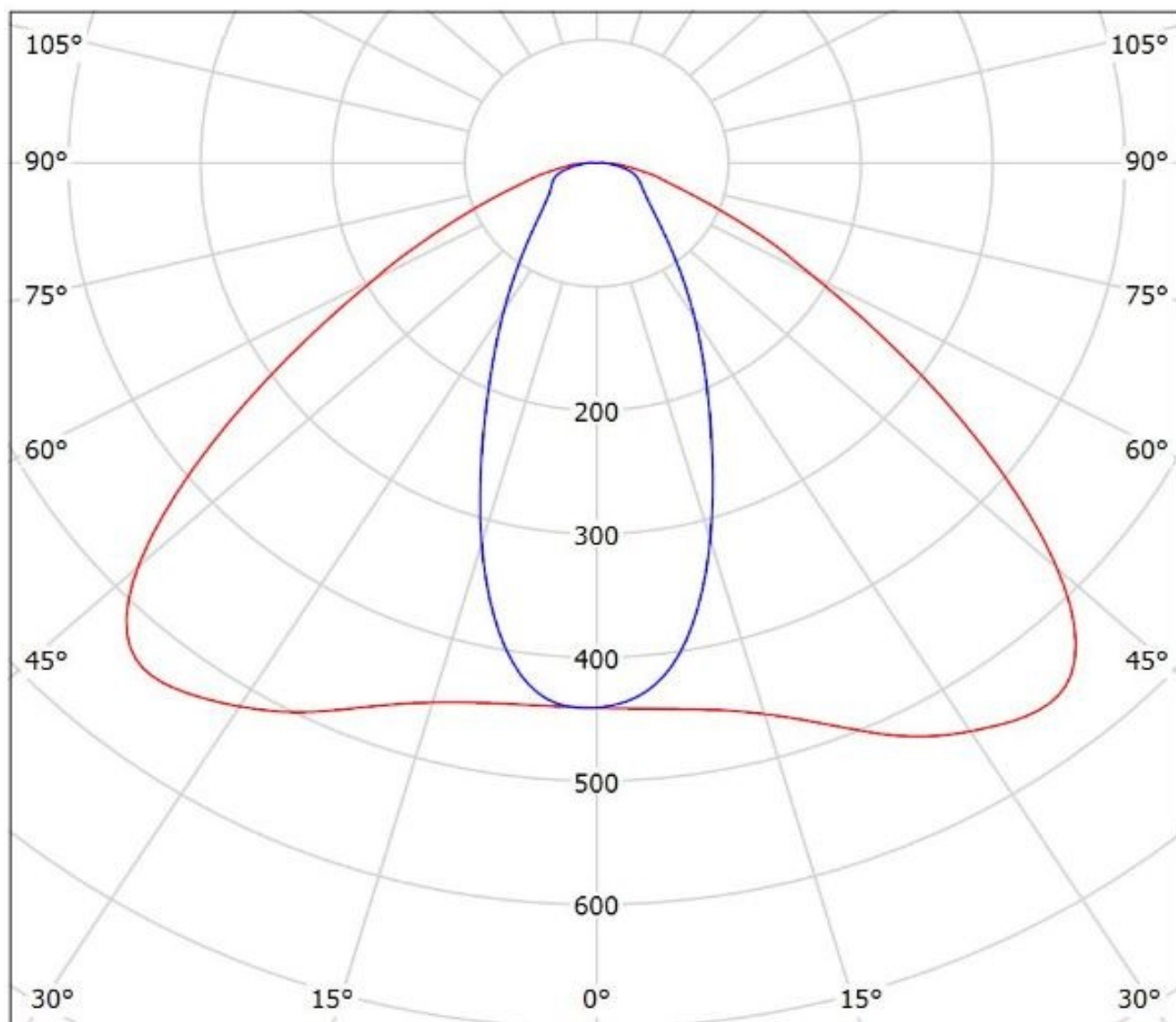

cd/klm

— C0 - C180 — C90 - C270

$\eta = 94\%$

Luminaire: Ledil C13936_STRADA-2x2-B2-STP_(H35C1)

Lamps: 1 x LG_H35C1_2x2_477.216lm@250mA_P=2.87475W_I=0.250A

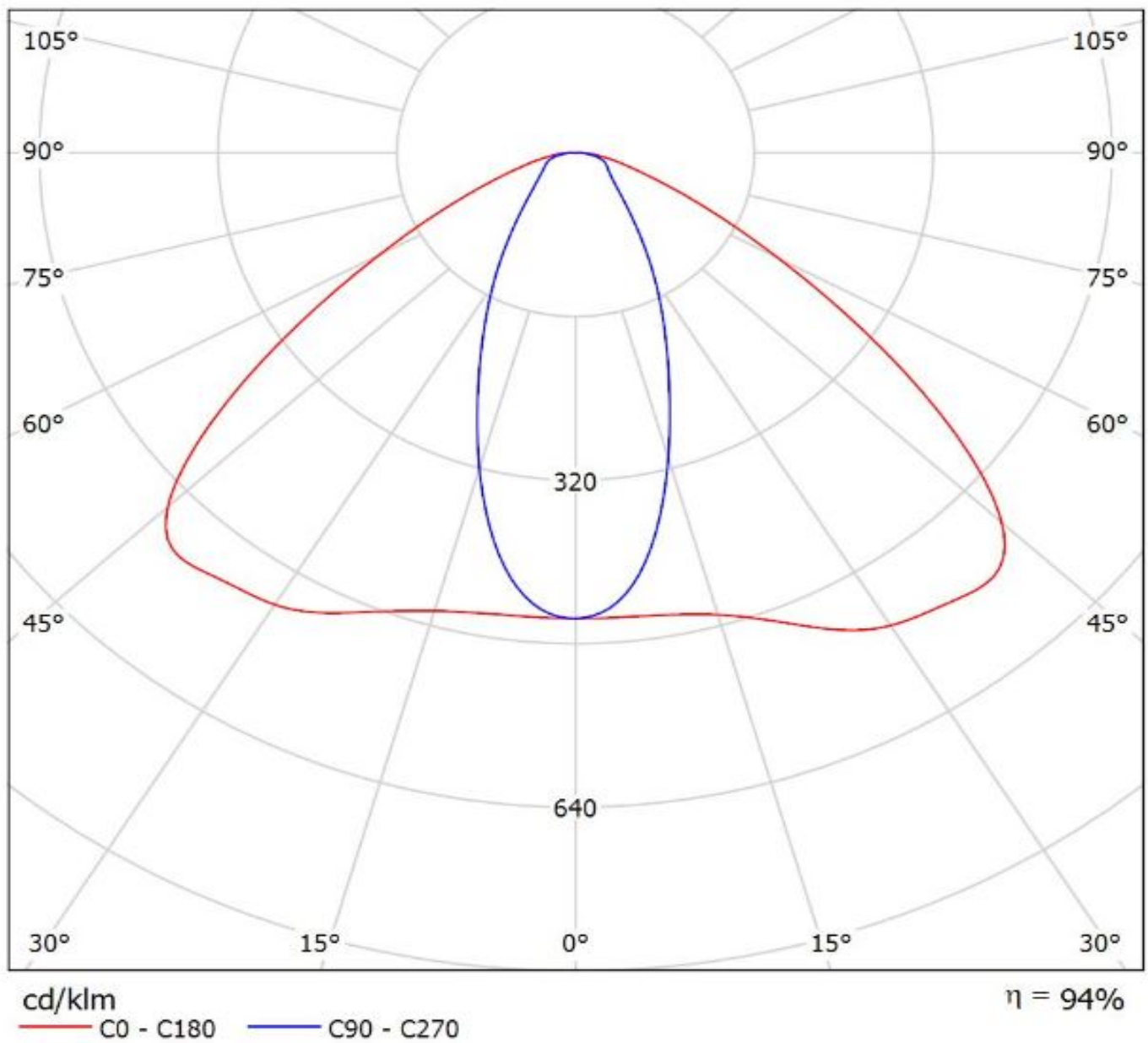

Luminaire: LEDiL Oy C13936_STRADA-2x2-B2-STP_(Luxeon_TX)
Lamps: 1 x Luxeon_TX_(L1T2-3585)_319.001lm@250mA_P=2.78902W_I=0.250A

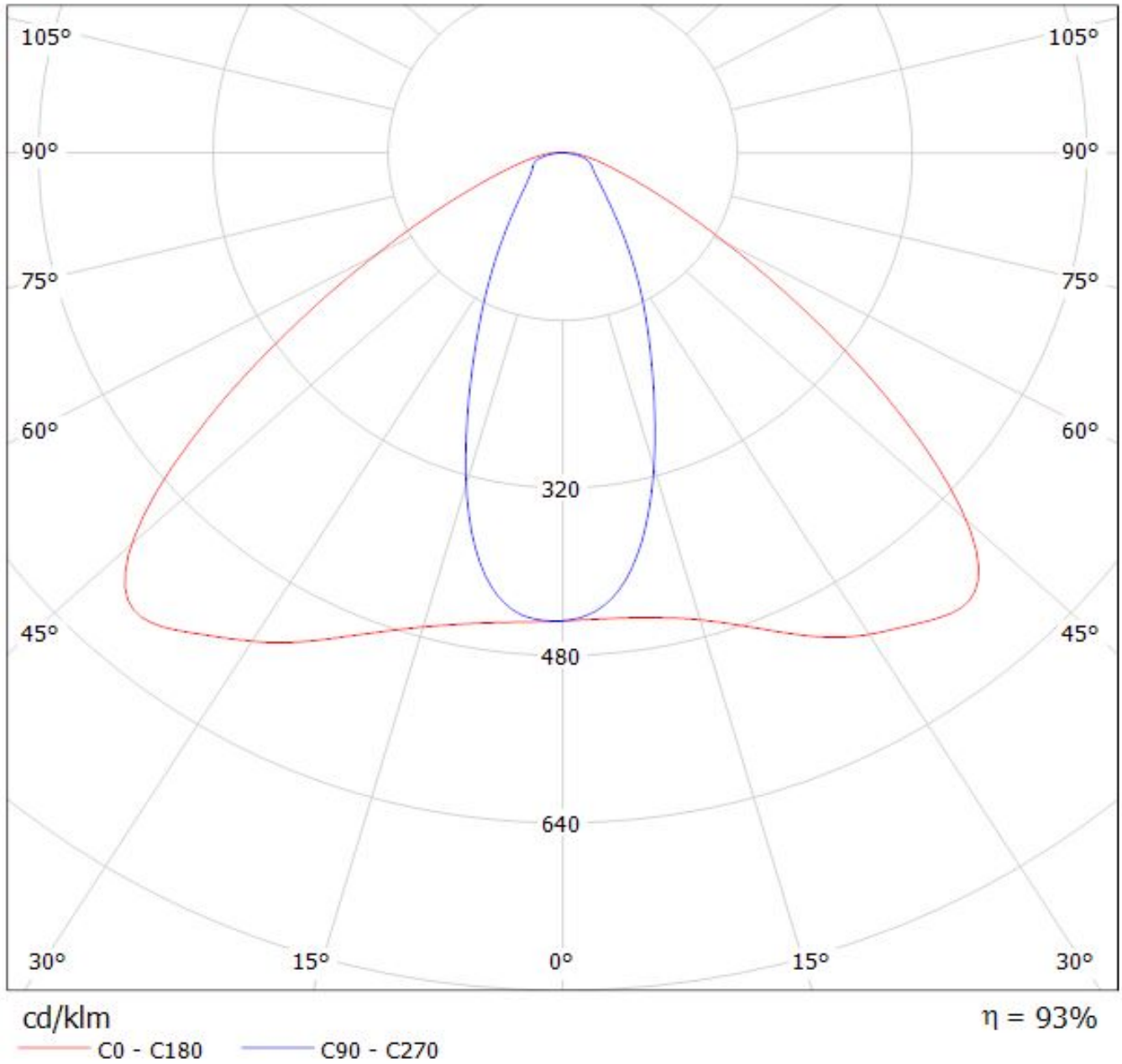

Luminaire: LEDiL Oy C13936_STRADA-2X2-B2-STP_(E21A)
Lamps: 1 x Nichia_E21A_452.248lm@250mA_2.805W_I=0.250A

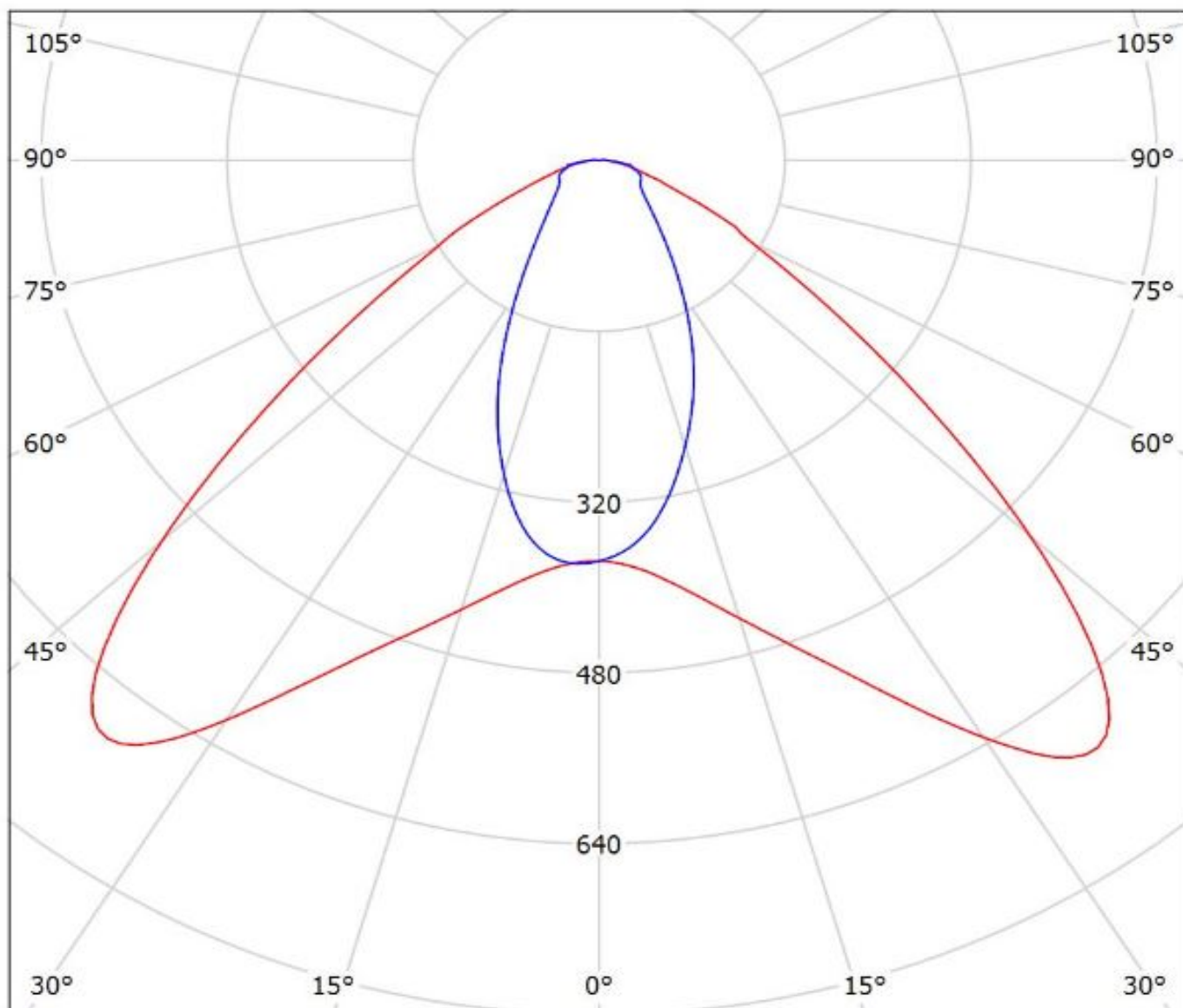

cd/klm

— C0 - C180 — C90 - C270

$\eta = 93\%$

Luminaire: LEDiL Oy C13936_STRADA-2X2-B2-STP_(NVSW319AE)
Lamps: 1 x Nichia_NVSW319AE_499.093lm@250mA_P=2.79052W_I=0.25A

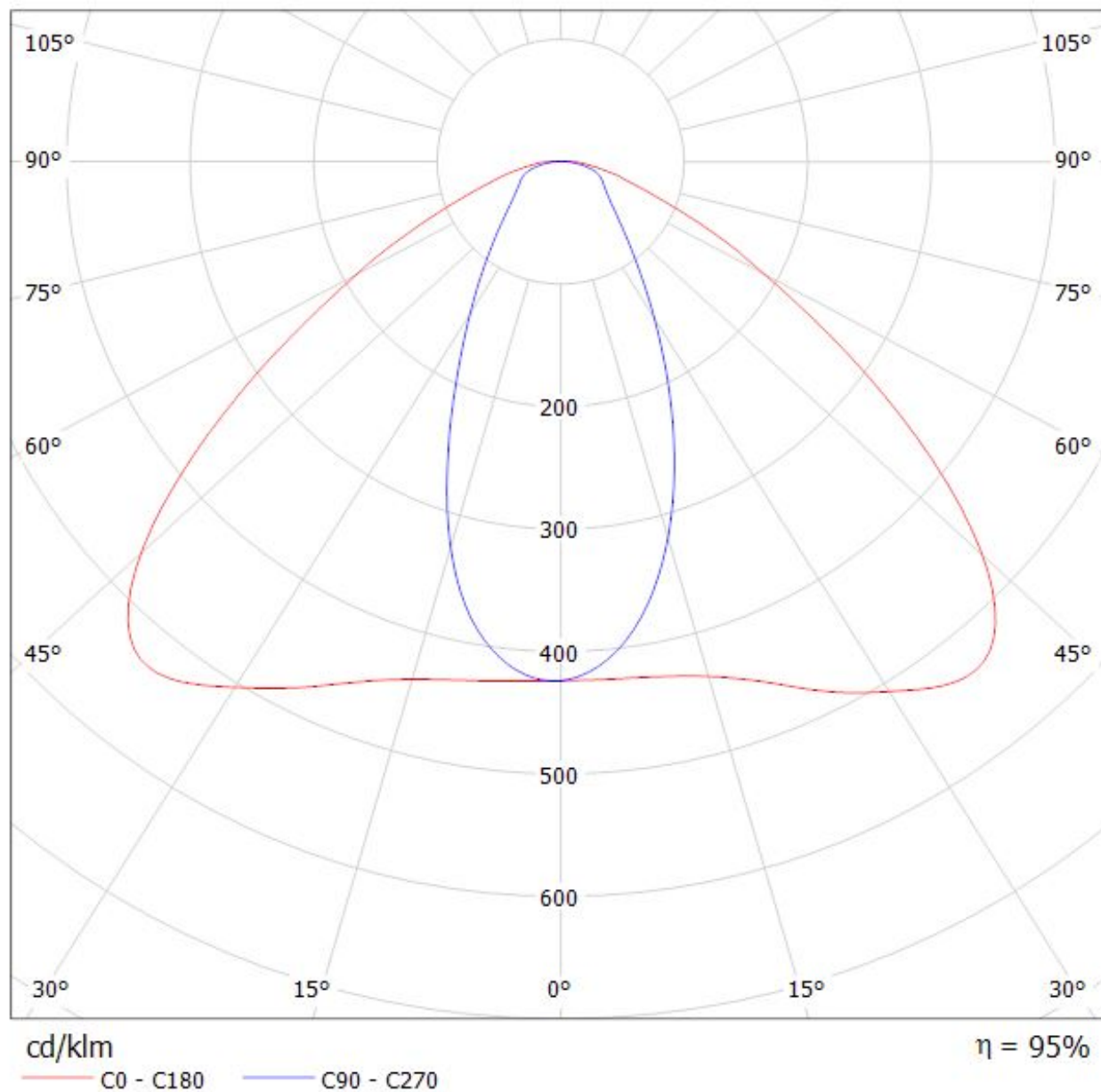

Luminaire: LEDiL Oy C13936_STRADA-2X2-B2-STP_(Oslon_Square_PC_2x2)
Lamps: 1 x Osram_Oslon_Square_PC_2x2_(GWCSSRM1.PC)
_411.322lm@250mA_P=2.85186W_I=0,2499A

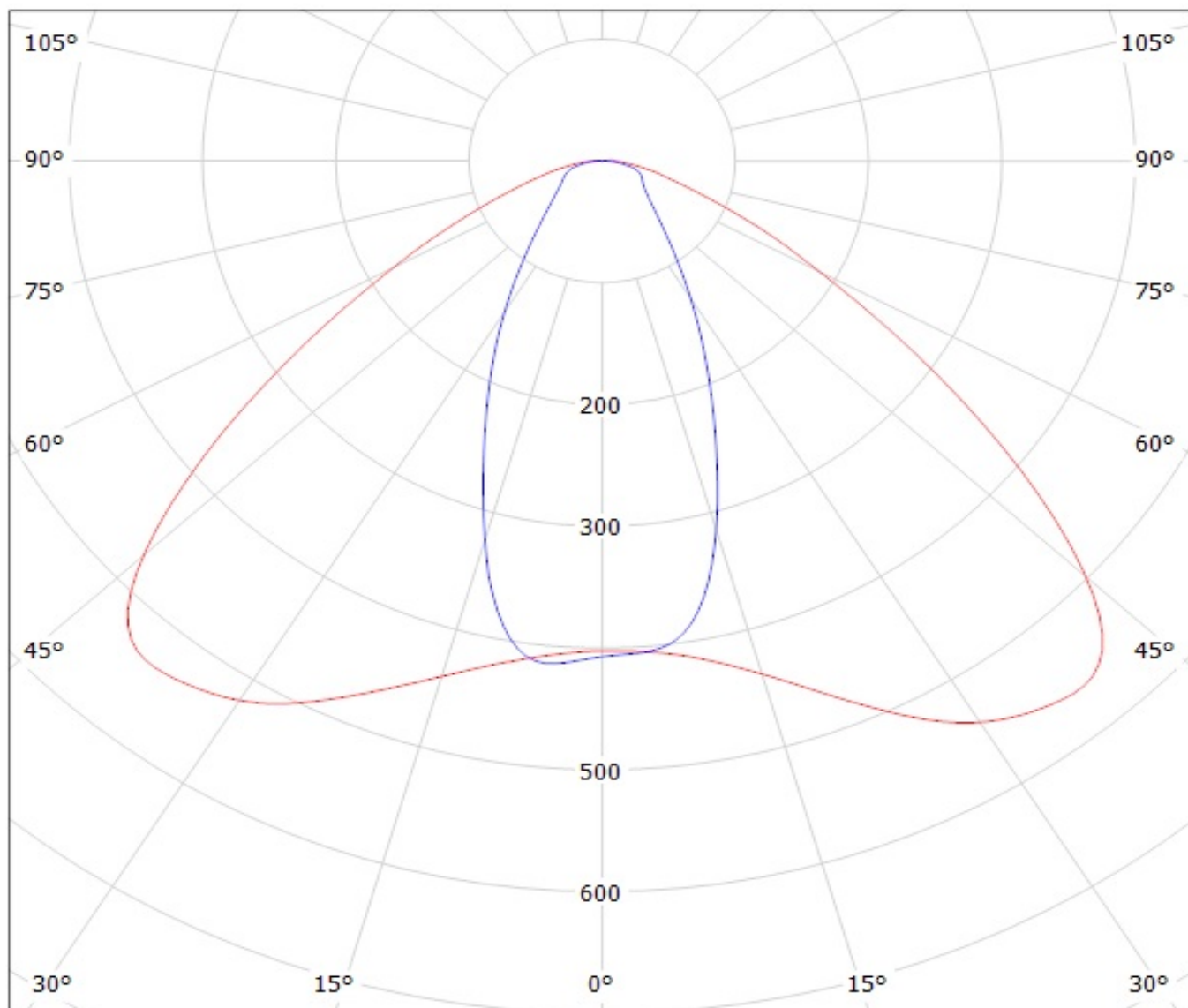

cd/klm

— C0 - C180 — C90 - C270

$\eta = 94\%$

Luminaire: Ledil C13936_STRADA-2x2-B2-STP_(Square_Gen3)

Lamps: 1 x Osram_Square_Gen3_(GW_CSSRM2.PM)_461.082lm@250mA_P=2.79075W_η=0.250A

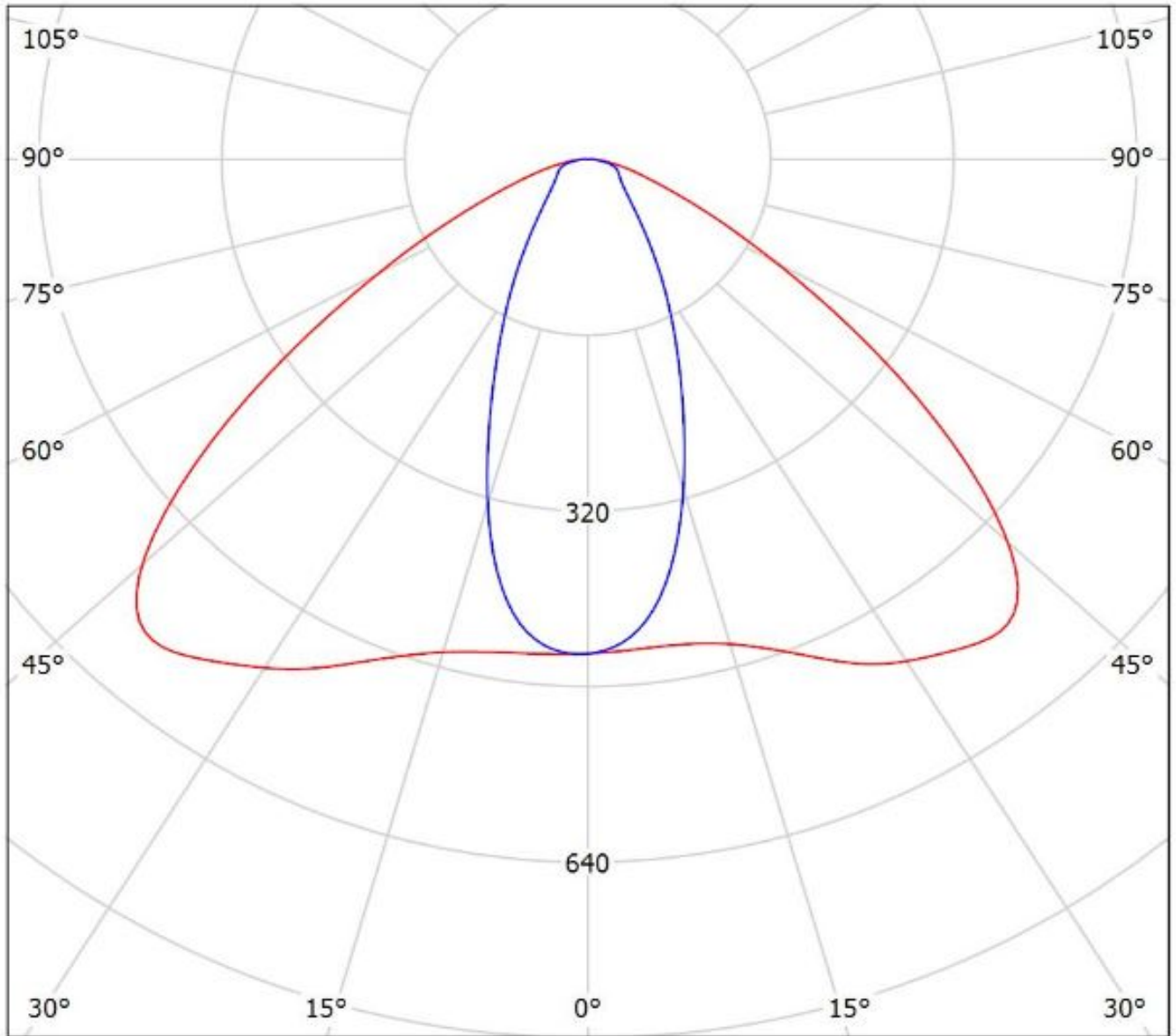

cd/klm

— C0 - C180 — C90 - C270

η = 93%

Luminaire: Ledil Oy C13936_STRADA-2X2-B2-STP_OSRAM_DURIS_P9_SIMULATED
Lamps: 1 x OSRAM DURIS P9

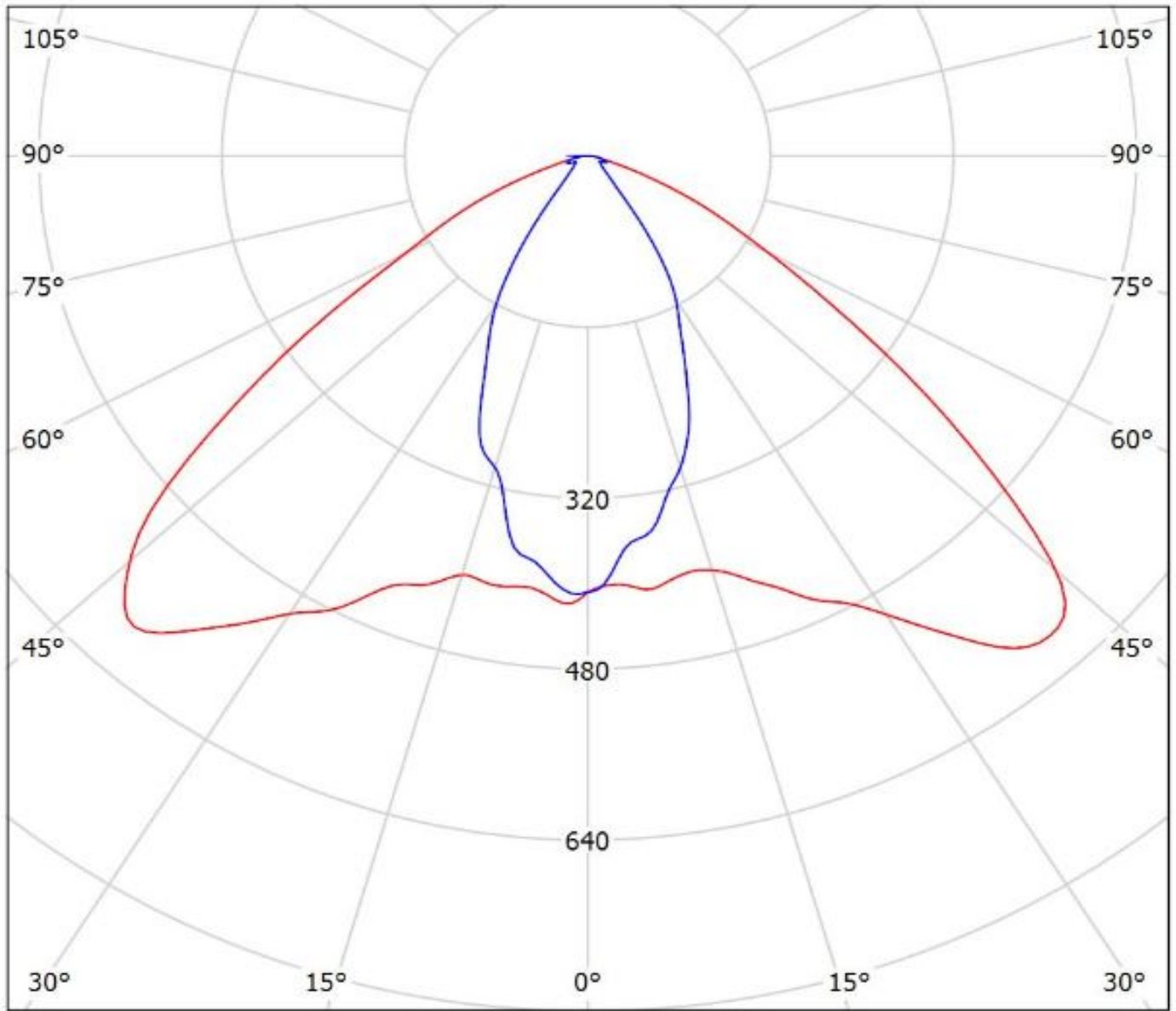

cd/klm

— C0 - C180 — C90 - C270

η = 95%

Luminaire: LEDiL Oy C13936_STRADA-2X2-B2-STP_(Fortimo_F-Flex_2x8_740DAG3)
Lamps: 1 x Philips_Fortimo_F-Flex_2x8_740DAG3_1786.86lm@250mA_P=11.6092W_I=0.2498A

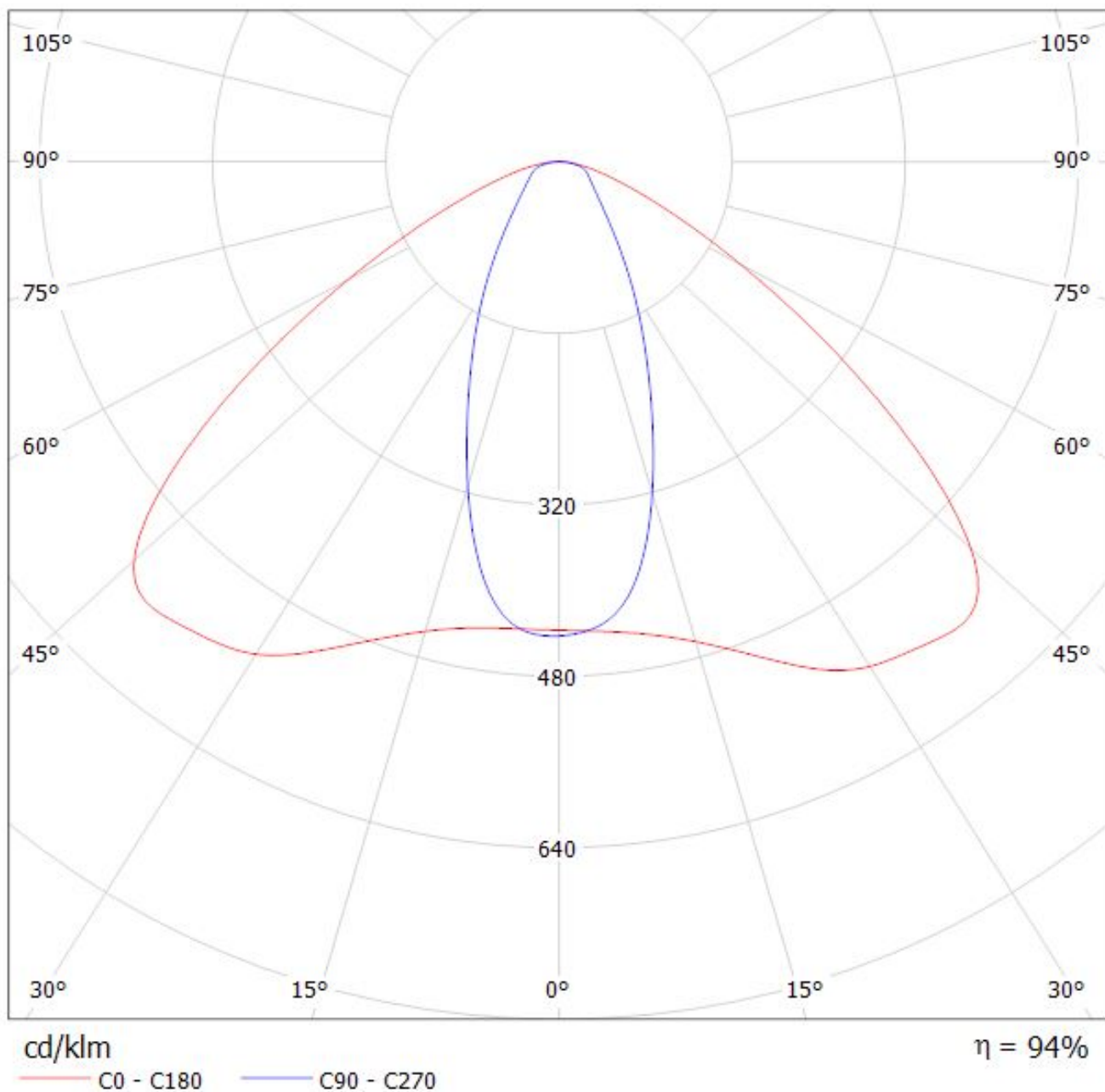

Luminaire: Ledil C13936_STRADA-2x2-B2-STP_(Fortimo FastFlex LED board 2x8 DAX G4)
Lamps: 1 x Fortimo FastFlex LED board 2x8 DAX G4

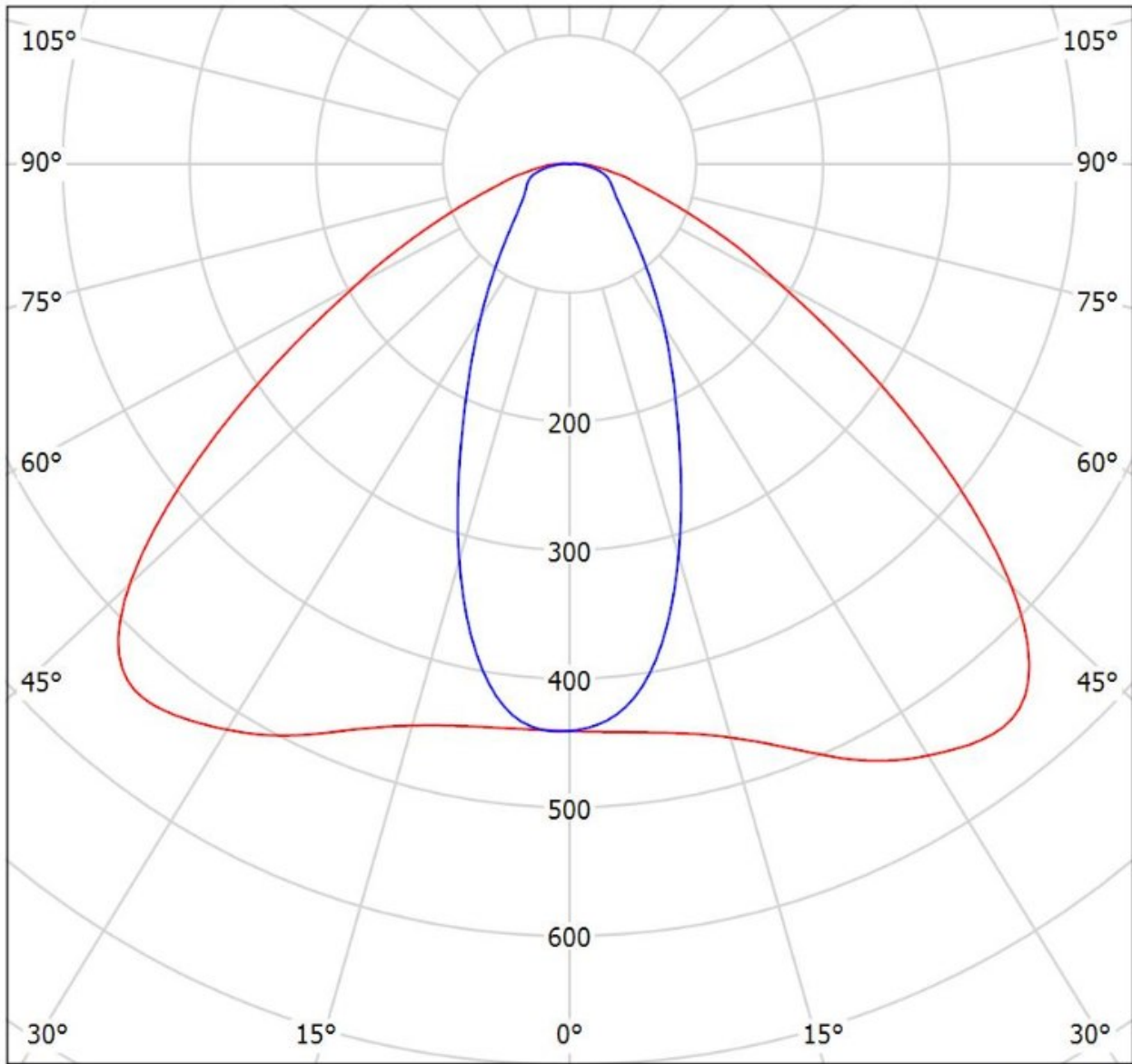

cd/klm

— C0 - C180 — C90 - C270

$\eta = 96\%$

Luminaire: LEDiL Oy C13936_STRADA-2X2-B2-STP_(LH351Z) Eff.93.1%
Lamps: 1 x SAMSUNG_LH351Z_2x2_359.49lm@250mA_P=2.86371W_I=249.8mA

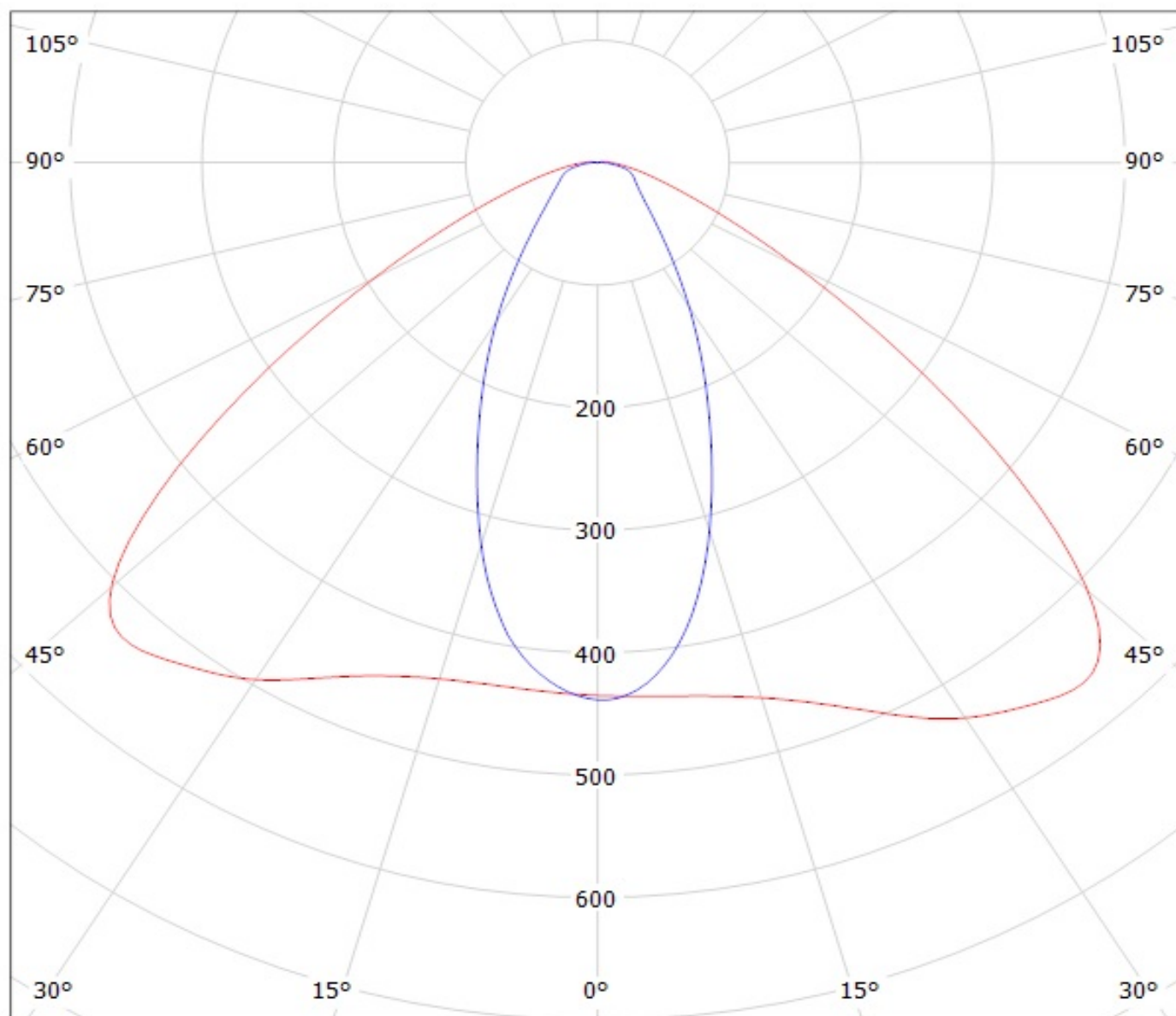

cd/klm

— C0 - C180

— C90 - C270

Luminaire: Ledil C13936_STRADA-2X2-B2-STP_(LH351B)

Lamps: 1 x Samsung_LH351B_2x2_444.178lm@250mA_P=2.8535W_I=0.25A

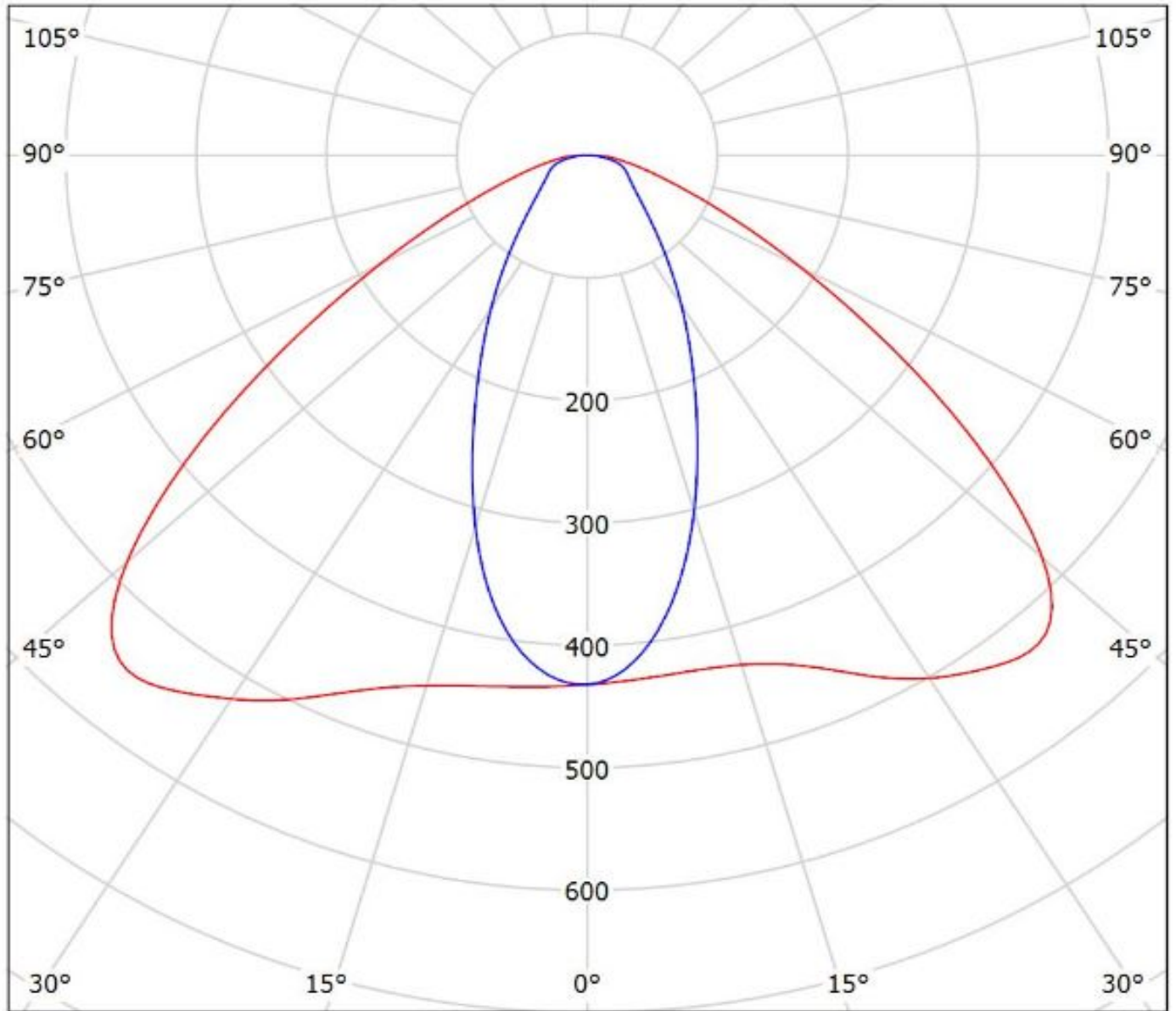

cd/klm

— C0 - C180

— C90 - C270

$\eta = 93\%$

Luminaire: LEDiL Oy C13936_STRADA-2X2-B2-STP_(Z8Y22+)

Lamps: 1 x Seoul_Z8Y22+_ (W6E2G)_498.702lm@250mA_P=2.72132W_I=0.250A

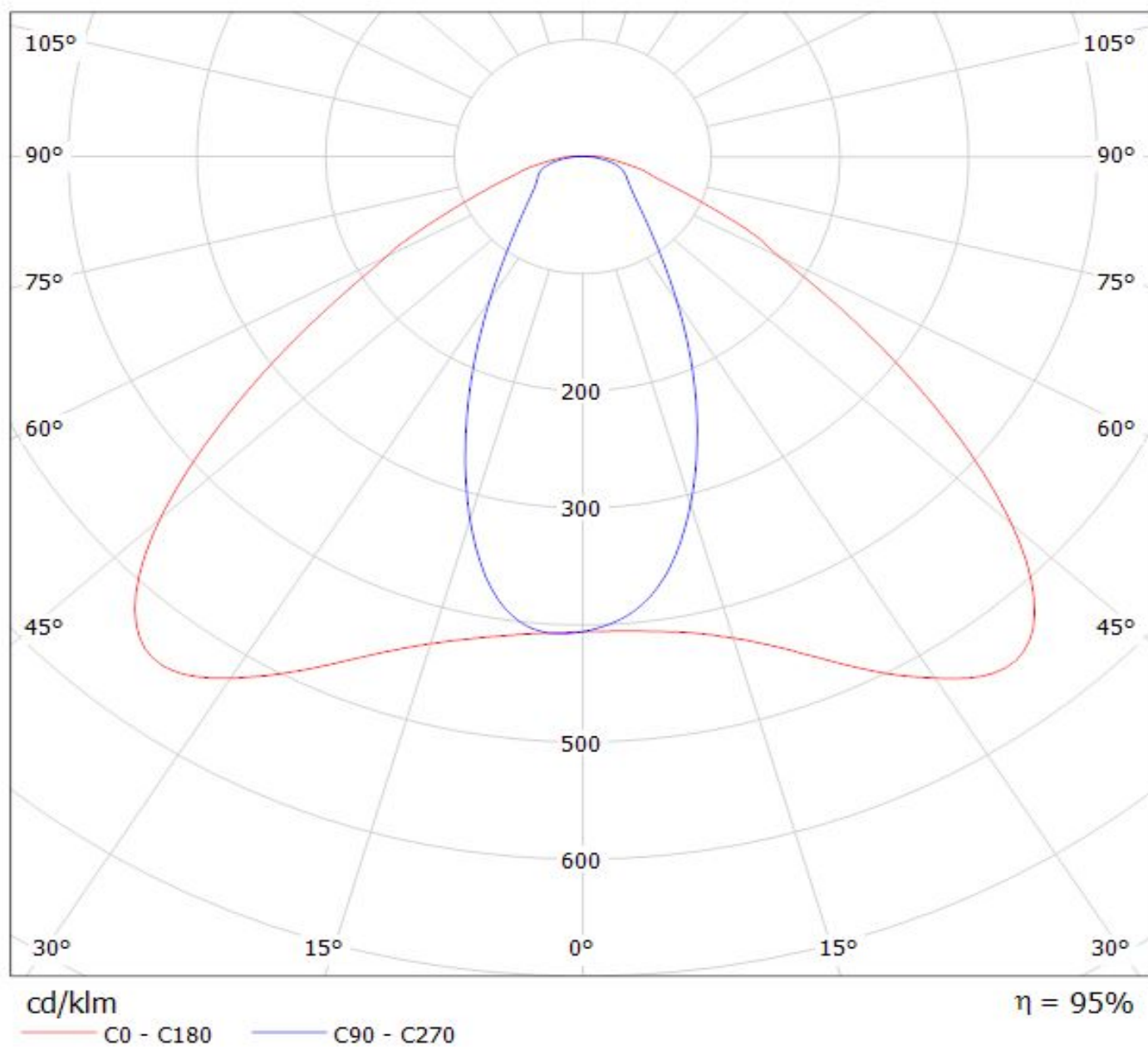

Luminaire: LEDiL Oy C13936_STRADA-2X2-B2-STP_(Z8Y22)

Lamps: 1 x Seoul_Wicop_Z8Y22_497.833lm@250mA_P=2.79801W_U=11.199V

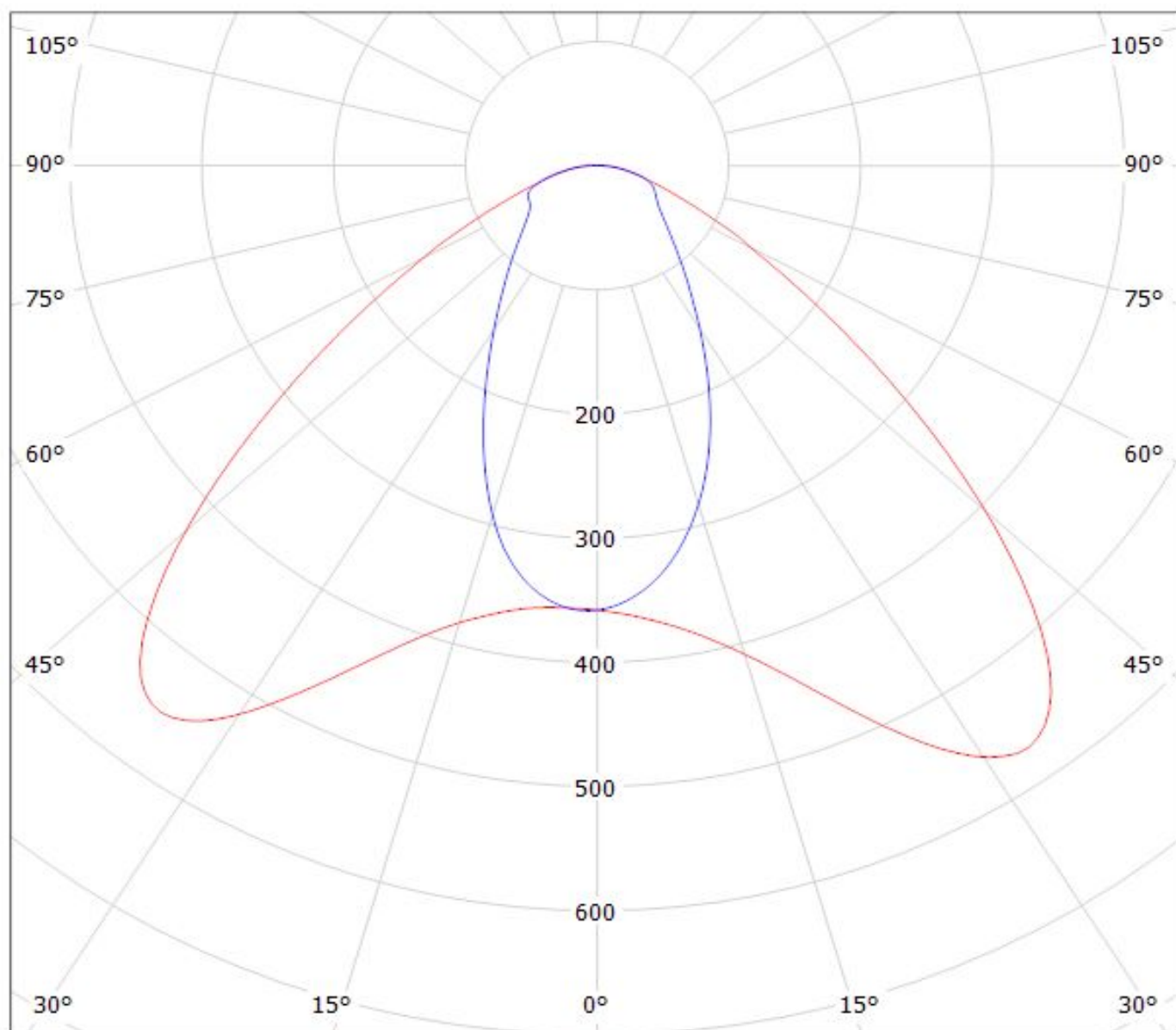

cd/klm

— C0 - C180 — C90 - C270

$\eta = 93\%$

Ledil C13936_STRADA-2X2-B2-STP_(TL1L4) / LDC (Polar)

Luminaire: Ledil C13936_STRADA-2X2-B2-STP_(TL1L4)

Lamps: 1 x Toshiba_TL1L4_2x2_(TL1L4-DW0)_472.639lm@250mA_CCT=6500K_P=2.9W_I=0.25A

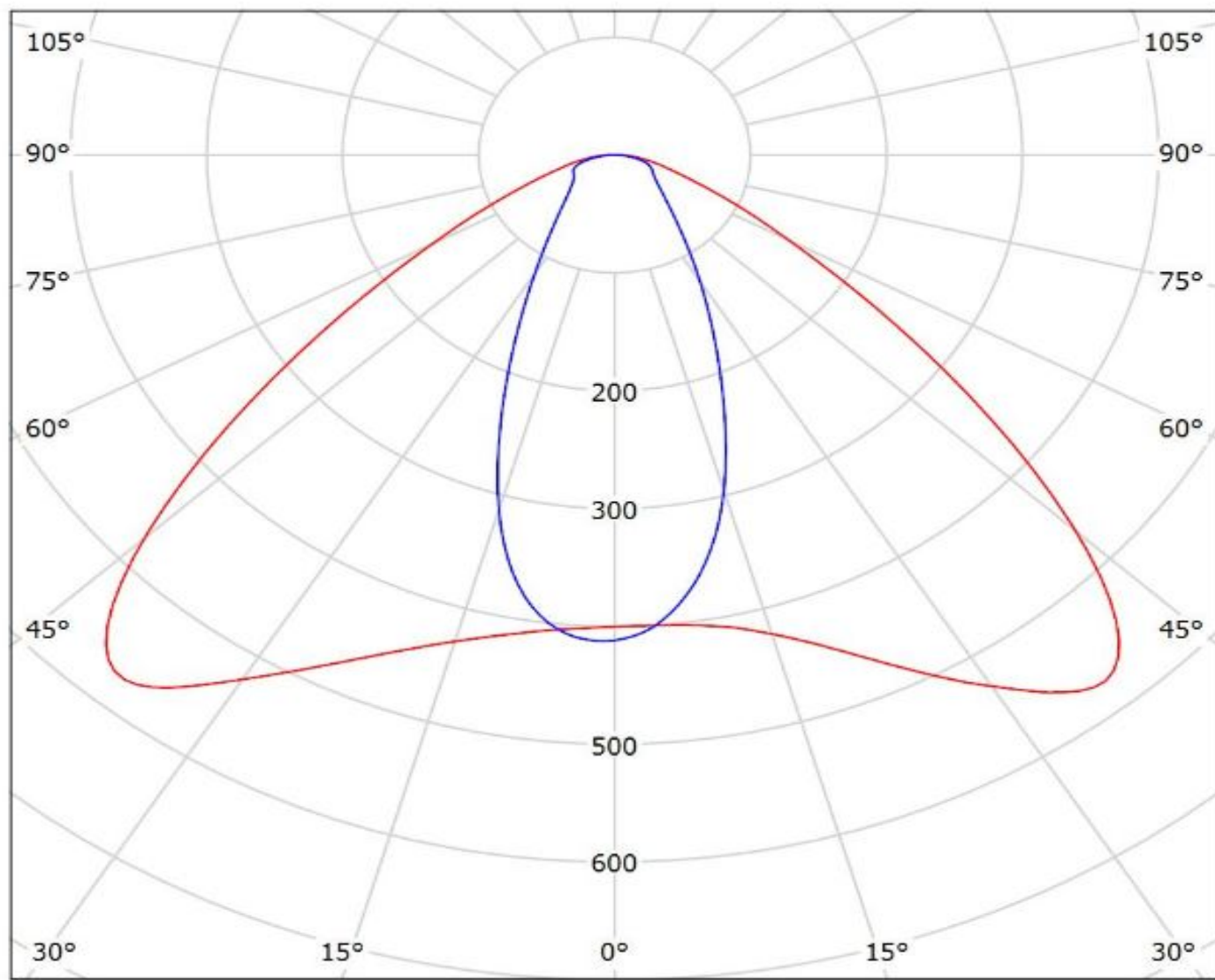

cd/km

— C0 - C180

— C90 - C270

$\eta = 88\%$

Luminaire: LEDiL Oy C13936_STRADA-2X2-B2-STP_(Tridonic_Module_RLE_G1)
Lamps: 1 x Tridonic_Module_RLE_G1_4576.03lm@700mA_P=32.0681W_I=0.700A

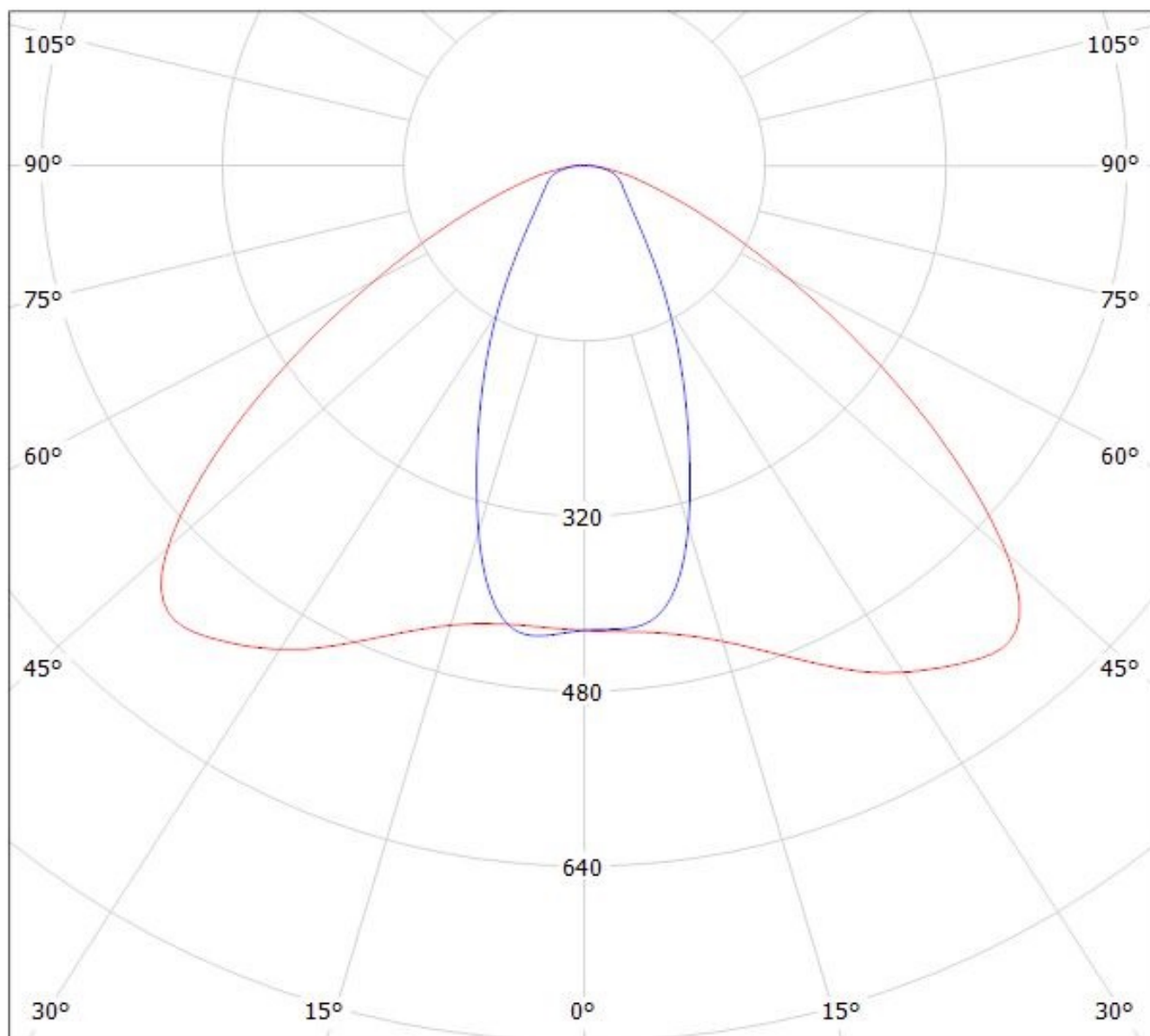

cd/klm

$\eta = 94\%$

— C0 - C180 — C90 - C270

Luminaire: LEDiL Oy C13936_STRADA-2X2-B2-STP_(Tridonic_Module_RLE_G1)
Lamps: 1 x Tridonic_Module_RLE_G1_4576.03lm@700mA_P=32.0681W_I=0.700A

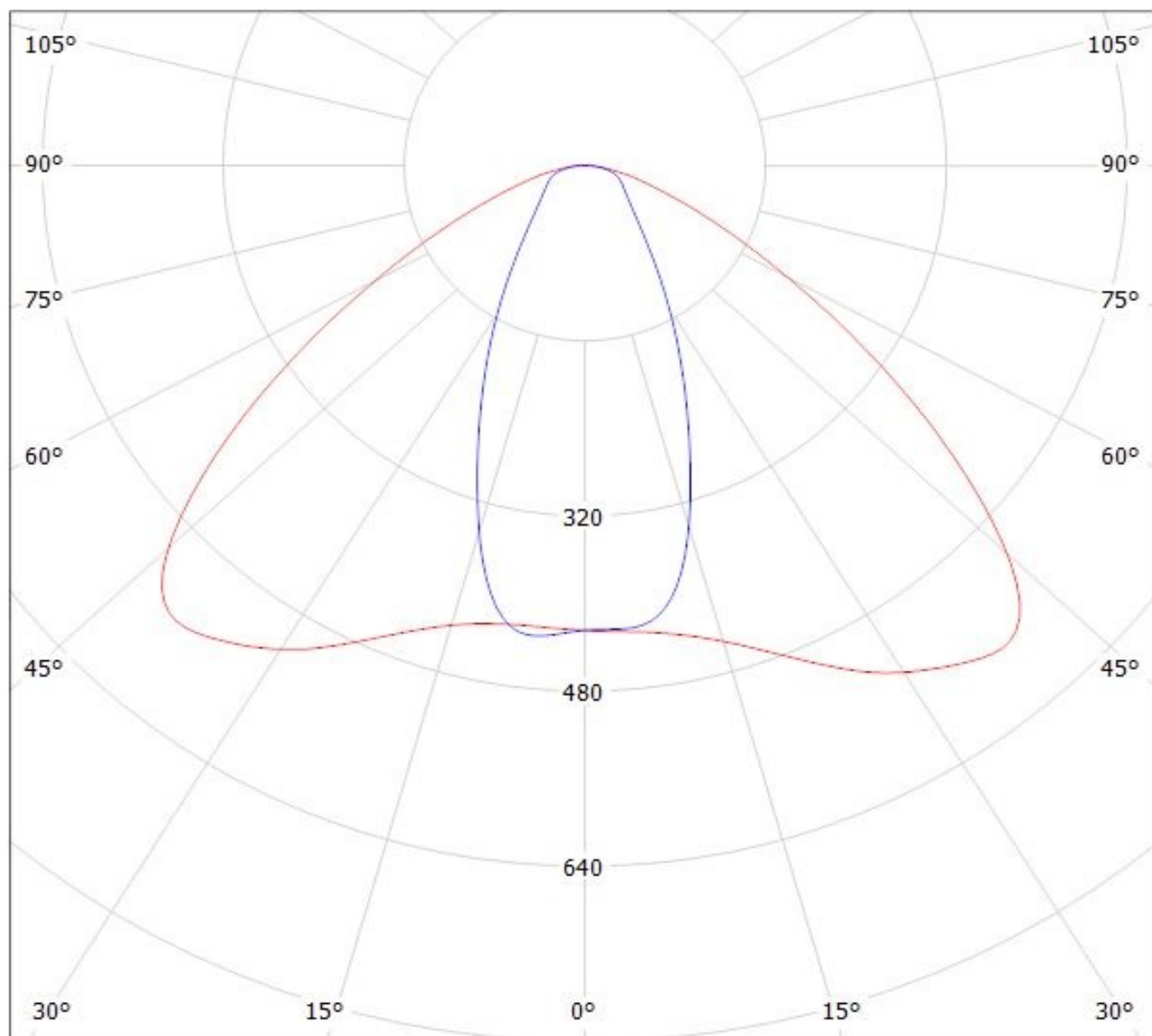

cd/klm

$\eta = 94\%$

— C0 - C180 — C90 - C270

Luminaire: LEDiL Oy C13936_STRADA-2X2-B2-STP_(Tridonic_Module_RLE_G1)
Lamps: 1 x Tridonic_Module_RLE_G1_2288lm@700mA_P=16W_I=0.700A

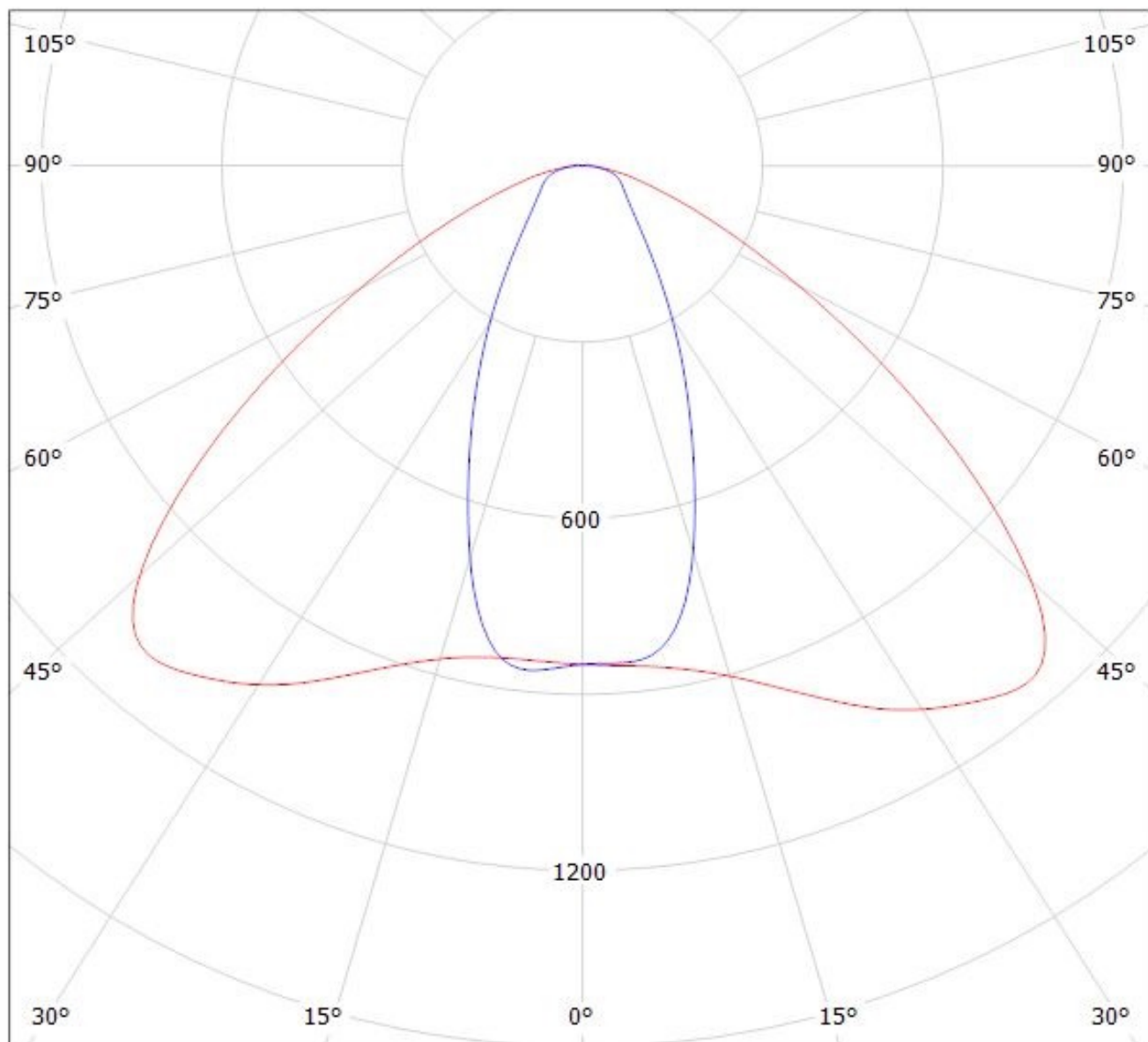

cd/klm

— C0 - C180 — C90 - C270

$\eta = 94\%$

Luminaire: LEDiL Oy C13936_STRADA-2X2-B2-STP_(Tridonic_Module_RLE_G1)
Lamps: 1 x Tridonic_Module_RLE_G1_2288lm@700mA_P=16W_I=0.700A

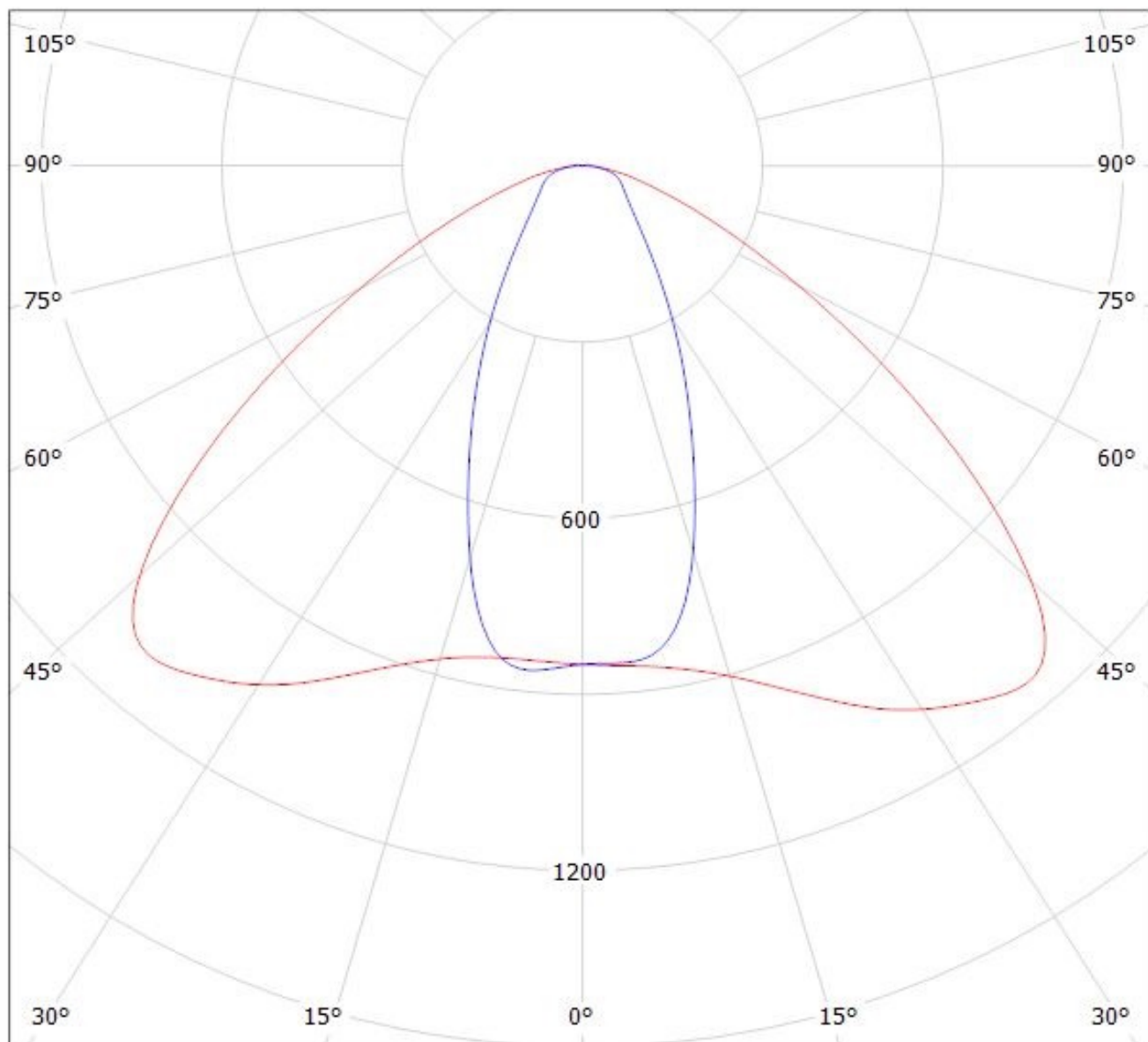

cd/klm

— C0 - C180 — C90 - C270

$\eta = 94\%$

NOTE: The typical divergence will be changed by different color, chip size and chip position tolerance. The typical total divergence is the full angle measured where the luminous intensity is half of the peak value.

X-ON Electronics

Largest Supplier of Electrical and Electronic Components

Click to view similar products for [LED Lighting Lenses](#) category:

Click to view products by [Ledil](#) manufacturer:

Other Similar products are found below :

[LL01ED-AK40L06](#) [LL01ZZ-EX25L06-M2](#) [180182-0000](#) [FNP-N2-N083-0R NRW](#) [LL01ED-ALI55R49](#) [0190535300](#) [0410111300](#)
[0510113303](#) [0530997](#) [2710121](#) [C11004_TINA2-RS](#) [C12231_LENA-FRESNEL-LENS](#) [LL01ED-AKY24R49](#) [LL01CR-AYG15R49](#)
[LL01CR-OT32L06-M2](#) [LL01ZZ-AAA24L49](#) [LL01CR-CEN38L02](#) [LL01ZZ-AAA55L49](#) [LL01CR-AYG24R49](#) [LL01A00CZMB2-M2](#)
[LL01ED-AKY38R49](#) [LL01CR-CNE2545L06-M2](#) [LL01ZZ-AAA38L49](#) [LL01ED-AKV36R49](#) [LL01ED-ALI24R49](#) [LL01CR-AYG38R49](#)
[FN15973_RONDA-REC-60-C](#) [F16859_LINDA-ZT25](#) [C14169_LENA-CLEAR-LENS](#) [C16125_OLGA-W](#) [C17410_SPORT-2X2-FT6](#)
[C17414_SPORT-2X2-S6](#) [C17409_SPORT-2X2-FT6W](#) [C17360_SPORT-2X2-FT60](#) [C17434_ILONA-WW](#) [F16636_LINDA-W60](#) [10003](#)
[10003/15](#) [10048](#) [10049](#) [10108](#) [CP10960_RGBX-SS](#) [CP12395_LXP3-W](#) [10415](#) [10510](#) [1-1000288-0](#) [F14487_FLORENCE-1R-MAXI-WG](#)
[12667](#) [C14165_STRADA-2X2-ME-WIDE2](#) [C14605_HB-2X2-RW](#)