

No.	Changes and/or Note No.	Date	Intr	No	Changes and/or Note No.	Date	Intr

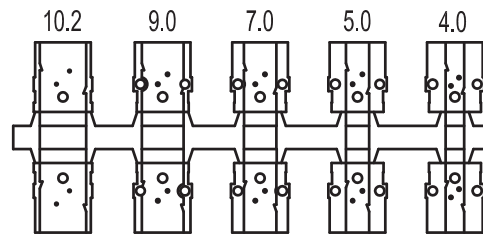
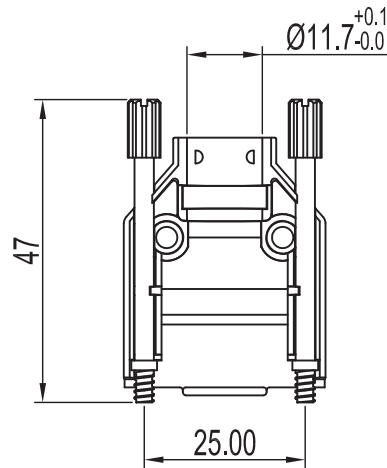
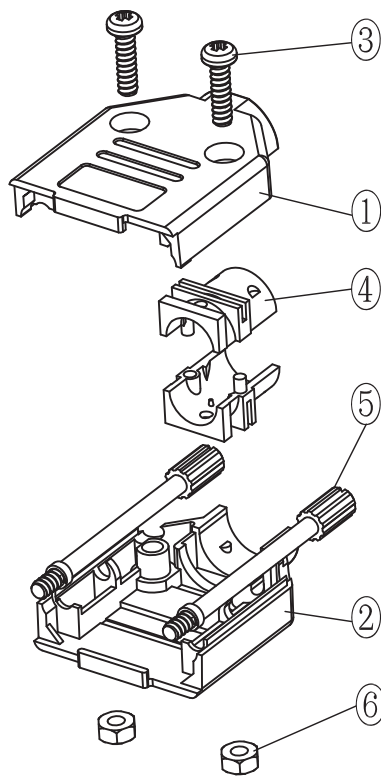
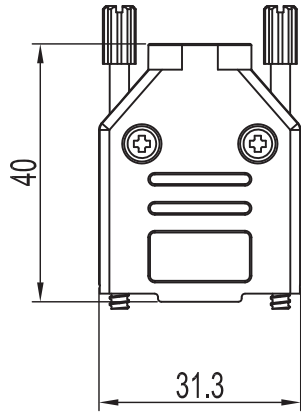

Grommet Set

Part Number:	Description:	Pack:	Item	QTY	Part description
6560-0108-01	DTPK09-P-K	Kit	1	1	DTPK09-Upper cover
			2	1	DTPK09-Lower cover
			3	2	M3X11.5 Screw
6561-0108-01	DTPK09-P	Bulk	4	1	D45ZK-D2 Grommet set
			5	2	UNC 4-40X47 Jackscrew
			6	2	M3 Nut
DATE: 2011-04-10	DRAWN: MRR	SCALE:	MATERIAL TYPE:		GENERAL TOLERANCES UNLESS OTHERWISE STATED LINEAR 0 ±0.20 0.0 ±0.15 0.00 ±0.10 ANGULAR ±0°30' ALL DIMENSIONS IN mm THIRD ANGLE PROJECTION
APPROVED:	REPLACES:				
		<h1>DTPK-P-SERIES</h1>			
				DRAWING No:	6688-9581

X-ON Electronics

Largest Supplier of Electrical and Electronic Components

Click to view similar products for [D-Sub Standard Connectors](#) category:

Click to view products by [Encitech](#) manufacturer:

Other Similar products are found below :

[DCM37S732N](#) [DAM15P500](#) [DEV09S364GTLF](#) [DEM09P032N](#) [DDM50P732N](#) [DAM15S332N](#) [173109-2218](#) [173109-2466](#) [173109-2436](#)
[173109-2435](#) [56F706-005-LI](#) [56F711-015](#) [015-0341-000](#) [015-0372-008](#) [015-8544-011](#) [017041-0005](#) [020419-0104](#) [012-0515-000](#) [012-9507-](#)
[034](#) [012-9507-114](#) [012-9534-001](#) [020745-0008](#) [609-25P](#) [M24308/2-23Z](#) [M243082310F](#) [M243082410F](#) [M243082411F](#) [M24308/4-21](#)
[CT1A18-11PSA206](#) [CT1N36-5SC](#) [CT2-16S-17PS](#) [CT2-20-15PCAU](#) [CT2-24-12PS](#) [CT2-24-28PSF127A206](#) [CT2-32-9PC](#) [CT6F9767-14-4-](#)
[14S-5PC](#) [CT6FA10SL-4PS](#) [CT7-18-10SC](#) [CT7-18-10SCAU](#) [CT7-18-12SCAU](#) [CT7-18-1PC](#) [CT7-18-1PCAU](#) [CT7-18-21SCAU](#) [M83513/01-](#)
[FC](#) [M83723/76W24619 L/C](#) [M85049/48-3-2F](#) [69001-865](#) [6STD09PCM99B70X](#) [6STD09SCM99B30X](#) [6STD09SCT99S40X](#)