

Sensing range
2 mm

Inductive sensor

- Short-circuit protection (pulsed)
- High switching frequency
- Robust brass housing, nickel-plated with fine thread
M12 x 1 mm
- Enclosure rating IP 67

Dimensional drawing

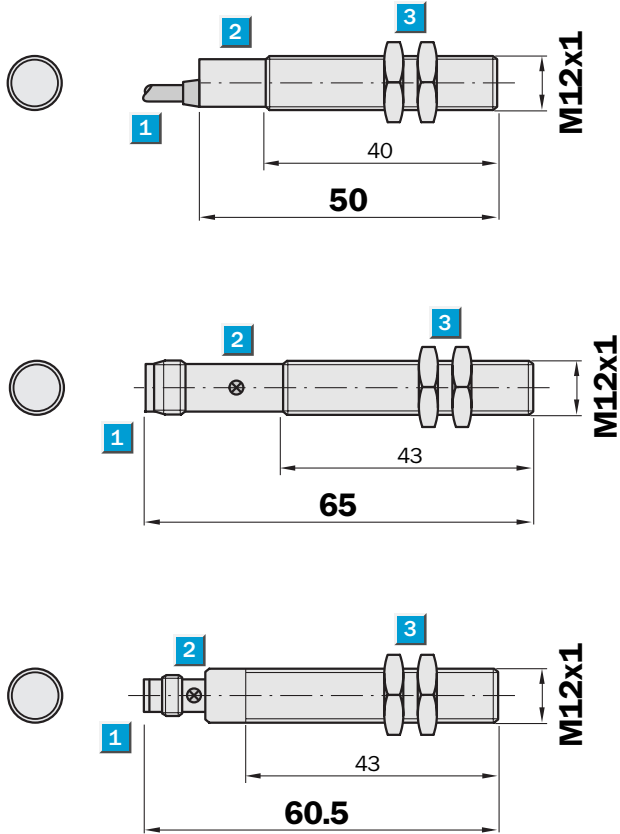

- 1 Connection
- 2 Display LED
- 3 Fastening nuts (2 x); width across 17, metal



Connection type

IM12-02BNO-ZW1	IM12-02BPS-ZT1	IM12-02BNS-ZC1	IM12-02BNO-ZC1
IM12-02BNS-ZW1	IM12-02BNS-ZT1	IM12-02BPS-ZC1	IM12-02BPO-ZC1
IM12-02BPO-ZW1			
IM12-02BPS-ZW1			

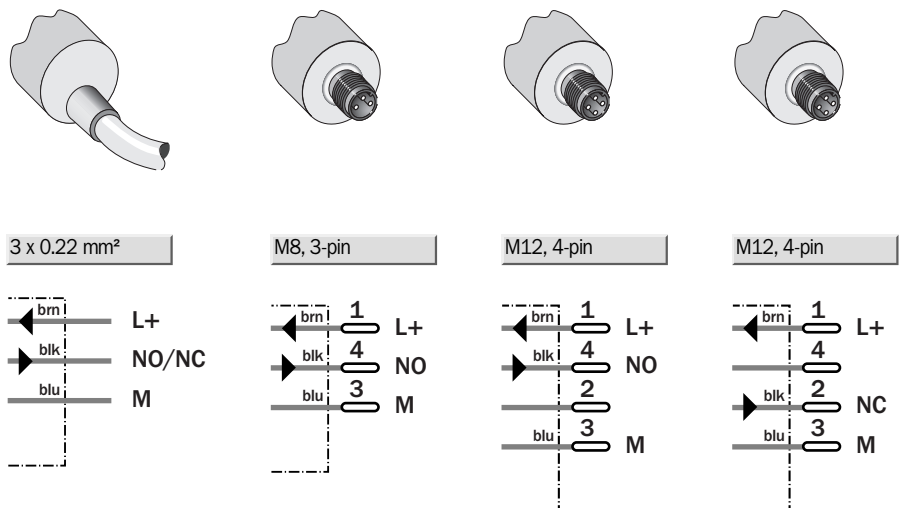

See chapter Accessories

Connector, M12, 4-pin
Connector, M8, 3-pin
Mounting systems

Technical data		IM12-	02BNO -ZW1	02BNS -ZW1	02BPO -ZW1	02BPS -ZW1	02BNS -ZC1	02BNO -ZC1	02BPO -ZC1	02BPS -ZC1	02BPS -ZT1	02BNS -ZT1
Sensing range S_n	2 mm											
Electrical configuration	DC 3-wire											
Supply voltage V_s	DC 10 ... 30 V											
Residual ripple V_{pp}	$\leq 10\%$ ¹⁾											
Voltage drop V_d	$\leq 1.2\text{ V}$ ²⁾											
Power consumption	$\leq 20\text{ mA}$ ³⁾											
Continuous current I_a	$\leq 200\text{ mA}$											
Time delay before availability t_v	$\leq 100\text{ ms}$											
Hysteresis H, of s_r	2 ... 10 %											
Repeatability R	$\leq 2\%$ (U_b and T_a constant) ⁴⁾											
Temperature drift, of s_r	$\pm 10\%$											
EMC	According to EN 60947-5-2											
Switching output	NPN											
	PNP											
Output function	Normally open											
	Normally closed											
Installation	Flush											
Connection type	Connector, M8, 3-pin											
	Connector, M12, 4-pin											
	Cable, PVC, 2 m											
Enclosure rating	IP 67 ⁵⁾											
Max. switching frequency	2,000 Hz											
Dimensions	M12 x 1 ⁶⁾											
Short circuit protection	✓ ⁷⁾											
Reverse polarity protection	✓											
Power-up pulse suppression	✓											
Shock/vibration stress	30 g, 11 ms/10 ... 55 Hz, 1 mm											
Ambient operating temperature T_a	-25 °C ... +70 °C											
Housing material	Brass nickel-plated, plastic											
Tightening torque	10 Nm											

¹⁾ of U_b
²⁾ at I_a max

³⁾ without load
⁴⁾ of s_r

⁵⁾ according to EN 60529
⁶⁾ thread diameter x pitch (mm)

⁷⁾ (pulsed)

Order information

Type	Order no.
IM12-02BNO-ZW1	6 011 966
IM12-02BNS-ZW1	6 011 964
IM12-02BPO-ZW1	6 011 965
IM12-02BPS-ZW1	6 011 963
IM12-02BNS-ZC1	6 011 972
IM12-02BNO-ZC1	6 011 974
IM12-02BPO-ZC1	6 011 973
IM12-02BPS-ZC1	6 011 971
IM12-02BPS-ZT1	6 011 967
IM12-02BNS-ZT1	6 011 968

Sensing range
4 mm

Inductive sensor

- Short-circuit protection (pulsed)
- High switching frequency
- Robust brass housing, nickel-plated with fine thread
- M12 x 1 mm
- Enclosure rating IP 67

Dimensional drawing

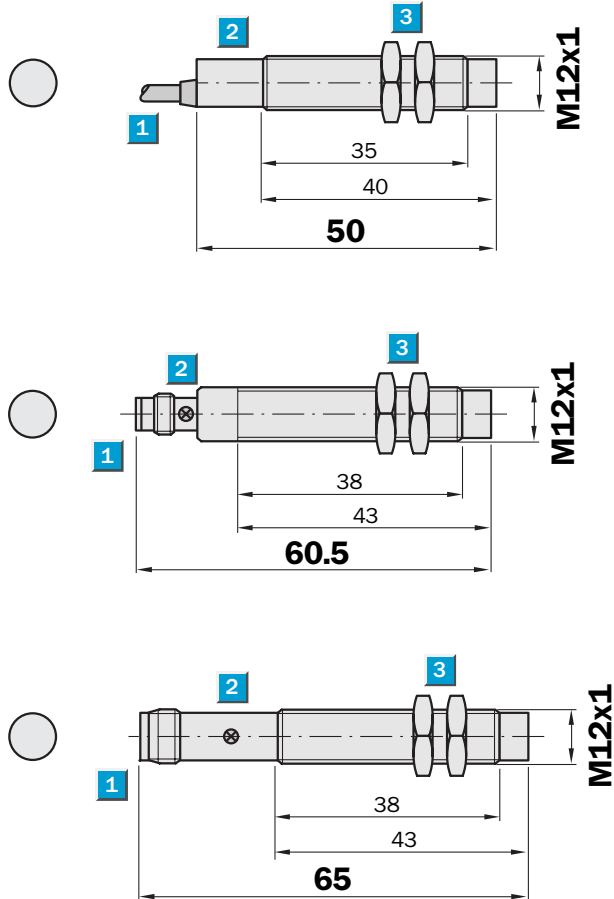

- 1 Connection
- 2 Display LED
- 3 Fastening nuts (2 x); width across 17, metal



Connection type

IM12-04NNS-ZW1	IM12-04NPS-ZT1	IM12-04NNS-ZC1	IM12-04NPO-ZC1
IM12-04NPS-ZW1	IM12-04NNS-ZT1	IM12-04NPS-ZC1	
IM12-04NPO-ZW1			

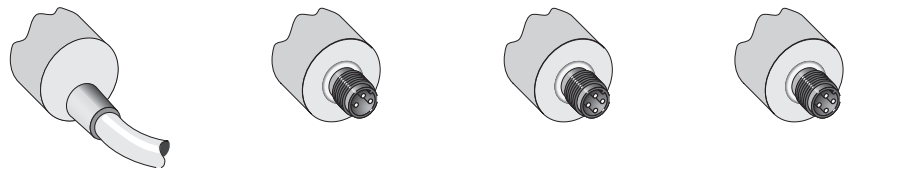

See chapter Accessories

Connector, M12, 4-pin

Connector, M8, 3-pin

Mounting systems

3 x 0.22 mm²

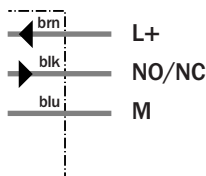

M8, 3-pin

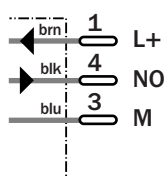

M12, 4-pin

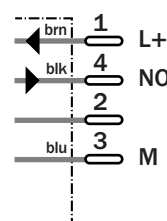

M12, 4-pin

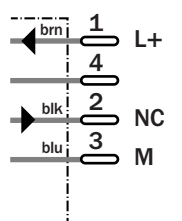

Technical data		IM12-	04NNS-ZW1	04NPS-ZW1	04NPO-ZW1	04NNS-ZC1	04NPO-ZC1	04NPS-ZC1	04NPS-ZT1	04NNS-ZT1		
Sensing range S_n	4 mm											
Electrical configuration	DC 3-wire											
Supply voltage V_s	DC 10 ... 30 V											
Residual ripple V_{pp}	$\leq 10\%$ ¹⁾											
Voltage drop V_d	$\leq 1.2\text{ V}$ ²⁾											
Power consumption	$\leq 20\text{ mA}$ ³⁾											
Continuous current I_a	$\leq 200\text{ mA}$											
Time delay before availability t_v	$\leq 100\text{ ms}$											
Hysteresis H, of s_r	2 ... 10 %											
Repeatability R	$\leq 2\%$ (U_b and T_a constant) ⁴⁾											
Temperature drift, of s_r	$\pm 10\%$											
EMC	According to EN 60947-5-2											
Switching output	NPN											
	PNP											
Output function	Normally open											
	Normally closed											
Installation	Non-flush											
Connection type	Connector, M8, 3-pin											
	Connector, M12, 4-pin											
	Cable, PVC, 2 m											
Enclosure rating	IP 67 ⁵⁾											
Max. switching frequency	2,000 Hz											
Dimensions	M12 x 1 ⁶⁾											
Short circuit protection	✓ ⁷⁾											
Reverse polarity protection	✓											
Power-up pulse suppression	✓											
Shock/vibration stress	30 g, 11 ms/10 ... 55 Hz, 1 mm											
Ambient operating temperature T_a	-25 °C ... +70 °C											
Housing material	Brass nickel-plated, plastic											
Tightening torque	10 Nm											

¹⁾ of U_b
²⁾ at I_a max
³⁾ without load
⁴⁾ of s_r
⁵⁾ according to EN 60529
⁶⁾ thread diameter x pitch (mm)
⁷⁾ (pulsed)

Order information

Type	Order no.
IM12-04NNS-ZW1	6 011 976
IM12-04NPS-ZW1	6 011 975
IM12-04NPO-ZW1	6 011 977
IM12-04NNS-ZC1	6 011 984
IM12-04NPO-ZC1	6 011 985
IM12-04NPS-ZC1	6 011 983
IM12-04NPS-ZT1	6 011 979
IM12-04NNS-ZT1	6 011 980

Sensing range
2 / 4 mm

Inductive sensor

- High switching frequency
- Short-circuit protection (pulsed)
- Robust brass housing, nickel-plated with fine thread
- M12 x 1 mm
- Enclosure rating IP 67

Dimensional drawing

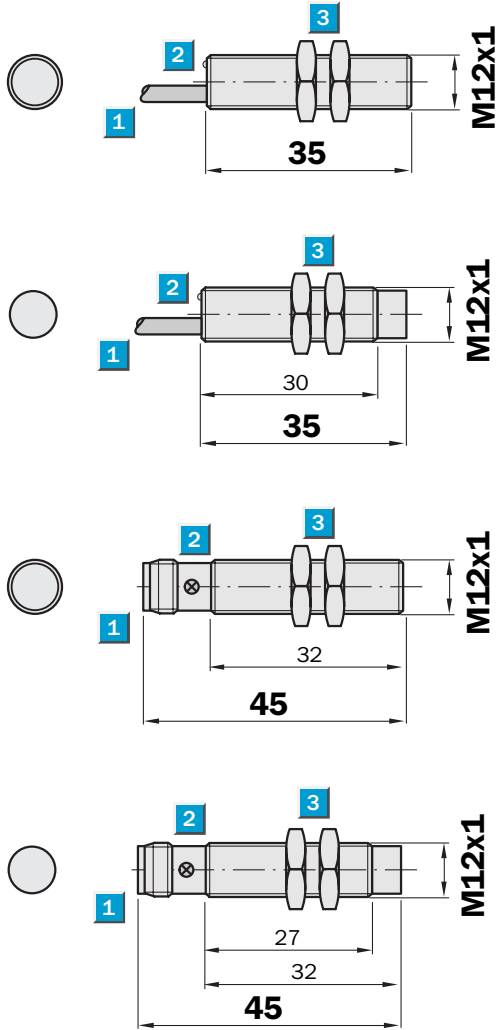

Connection type

IM12-02BNS-ZUK	IM12-02BPS-ZCK
IM12-02BPS-ZUK	IM12-02BNS-ZCK
IM12-04NNS-ZUK	IM12-04NPS-ZCK
IM12-04NPS-ZUK	IM12-04NNS-ZCK

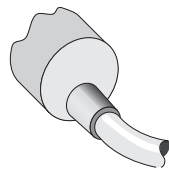

3 x 0.25 mm²

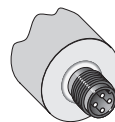
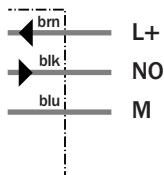

M12, 4-pin

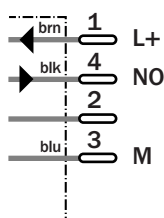

See chapter Accessories
Connector, M12, 4-pin
Mounting systems

Technical data		IM12-	02BNS -ZUK	02BPS -ZUK	02BPS -ZCK	02BNS -ZCK	04NNS -ZUK	04NPS -ZUK	04NPS -ZCK	04NNS -ZCK		
Sensing range S_n	4 mm											
	2 mm											
Electrical configuration	DC 3-wire											
Supply voltage V_s	DC 10 ... 30 V											
Residual ripple V_{pp}	$\leq 10\%$ ¹⁾											
Voltage drop V_d	$\leq 1.5\text{ V}$ ²⁾											
Power consumption	$\leq 10\text{ mA}$ ³⁾											
Continuous current I_a	$\leq 300\text{ mA}$											
Time delay before availability t_v	$\leq 2\text{ ms}$											
Hysteresis H, of s_r	1 ... 10 %											
Repeatability R	$\leq 1\%$ (U_b and T_a constant) ⁴⁾											
Temperature drift, of s_r	$\pm 10\%$											
EMC	According to EN 60947-5-2											
Switching output	NPN											
	PNP											
Output function	Normally open											
Installation	Non-flush											
	Flush											
Connection type	Connector, M12, 4-pin											
	Cable, PUR-PVC, 2 m											
Enclosure rating	IP 67 ⁵⁾											
Max. switching frequency	2,000 Hz											
Dimensions	M12 x 1 ⁶⁾											
Wire-break protection	✓											
Short circuit protection	✓ ⁷⁾											
Reverse polarity protection	✓											
Power-up pulse suppression	✓											
Shock/vibration stress	30 g, 11 ms/10 ... 55 Hz, 1 mm											
Ambient operating temperature T_a	-25 °C ... +75 °C											
Housing material	Brass nickel-plated, plastic											
Tightening torque	7 Nm											

¹⁾ of U_b
²⁾ at I_a max

³⁾ without load
⁴⁾ of s_r

⁵⁾ according to EN 60529
⁶⁾ thread diameter x pitch (mm)

⁷⁾ (pulsed)

Order information

Type	Order no.
IM12-02BNS-ZUK	1 017 438
IM12-02BPS-ZUK	1 017 426
IM12-02BPS-ZCK	1 017 428
IM12-02BNS-ZCK	1 017 440
IM12-04NNS-ZUK	1 017 439
IM12-04NPS-ZUK	1 017 427
IM12-04NPS-ZCK	1 017 429
IM12-04NNS-ZCK	1 017 441

Sensing range
4 mm

Inductive sensor

- Enhanced sensing range
- High switching frequency
- Short-circuit protection (pulsed)
- Robust brass housing, nickel-plated with fine thread
- M12 x 1 mm
- Enclosure rating IP 67

Dimensional drawing

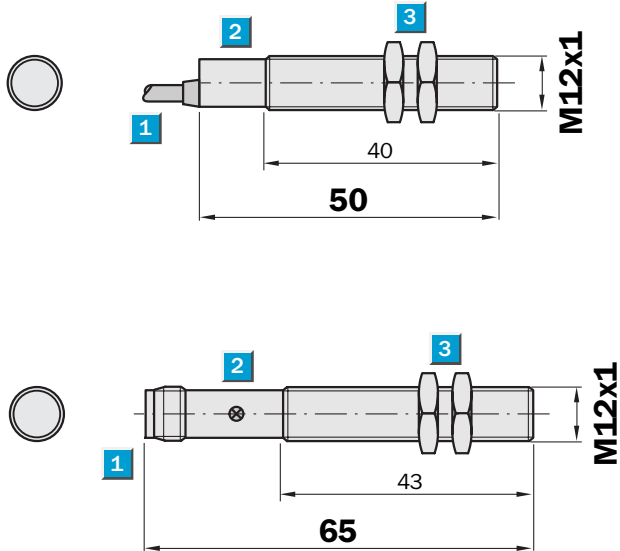

- 1 Connection
- 2 Display LED
- 3 Fastening nuts (2 x); width across 17, metal



Connection type

IM12-04BNS-ZW1	IM12-04BNS-ZC1	IM12-04BPO-ZC1
IM12-04BPO-ZW1	IM12-04BPS-ZC1	
IM12-04BPS-ZW1		

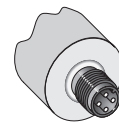
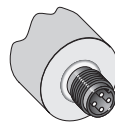
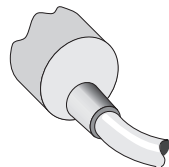

3 x 0.22 mm²

M12, 4-pin

M12, 4-pin

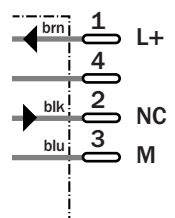
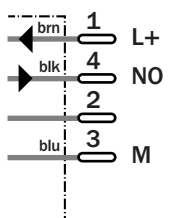
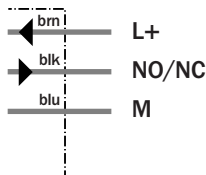

See chapter Accessories
Connector, M12, 4-pin
Mounting systems

Technical data		IM12-	04BNS -ZW1	04BPO -ZW1	04BPS -ZW1	04BNS -ZC1	04BPO -ZC1	04BPS -ZC1				
Sensing range S_n	4 mm											
Electrical configuration	DC 3-wire											
Supply voltage V_s	DC 10 ... 30 V											
Residual ripple V_{pp}	$\leq 10\%$ ¹⁾											
Voltage drop V_d	$\leq 1.2\text{ V}$ ²⁾											
Power consumption	$\leq 10\text{ mA}$ ³⁾											
Continuous current I_a	$\leq 200\text{ mA}$											
Time delay before availability t_v	$\leq 100\text{ ms}$											
Hysteresis H, of s_r	1 ... 15 %											
Repeatability R	$\leq 5\%$ (U_b and T_a constant) ⁴⁾											
Temperature drift, of s_r	$\pm 10\%$											
EMC	According to EN 60947-5-2											
Switching output	PNP											
	NPN											
Output function	Normally open											
	Normally closed											
Installation	Flush ⁵⁾											
Connection type	Connector, M12, 4-pin											
	Cable, PVC, 2 m											
Enclosure rating	IP 67 ⁶⁾											
Max. switching frequency	1,000 Hz											
Dimensions	M12 x 1 ⁷⁾											
Short circuit protection	✓ ⁸⁾											
Reverse polarity protection	✓											
Power-up pulse suppression	✓											
Shock/vibration stress	30 g, 11 ms/10 ... 55 Hz, 1 mm											
Ambient operating temperature T_a	-25 °C ... +70 °C											
Housing material	Brass nickel-plated, plastic											
Tightening torque	10 Nm											

¹⁾ of U_b
²⁾ at I_a max

³⁾ without load
⁴⁾ of s_r

⁵⁾ see installation notes
⁶⁾ according to EN 60529

⁷⁾ thread diameter x pitch (mm)
⁸⁾ (pulsed)

Order information

Type	Order no.
IM12-04BNS-ZW1	7 900 034
IM12-04BPO-ZW1	7 900 035
IM12-04BPS-ZW1	7 900 033
IM12-04BNS-ZC1	7 900 038
IM12-04BPO-ZC1	7 900 039
IM12-04BPS-ZC1	7 900 037

Sensing range
8 mm

Inductive sensor

- Enhanced sensing range
- High switching frequency
- Short-circuit protection (pulsed)
- Robust brass housing, nickel-plated with fine thread
- M12 x 1 mm
- Enclosure rating IP 67

Dimensional drawing

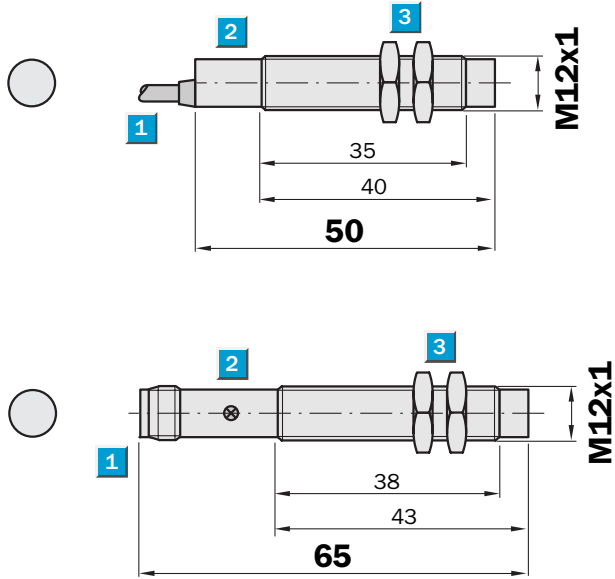

- 1 Connection
- 2 Display LED
- 3 Fastening nuts (2 x); width across 17, metal



Connection type

IM12-08NNO-ZW1	IM12-08NNS-ZC1	IM12-08NPO-ZC1
IM12-08NNS-ZW1	IM12-08NPS-ZC1	
IM12-08NPO-ZW1		
IM12-08NPS-ZW1		

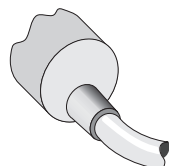

3 x 0.22 mm²

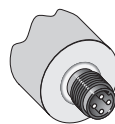
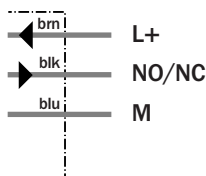

M12, 4-pin

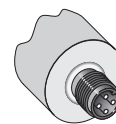
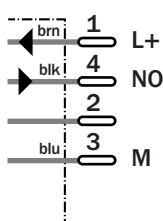

M12, 4-pin

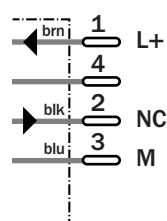

See chapter Accessories
Connector, M12, 4-pin
Mounting systems

Technical data		IM12-	08NN O-ZW1	08NNS -ZW1	08NPO -ZW1	08NPS -ZW1	08NNS -ZC1	08NPO -ZC1	08NPS -ZC1			
Sensing range S_n	8 mm											
Electrical configuration	DC 3-wire											
Supply voltage V_s	DC 10 ... 30 V											
Residual ripple V_{pp}	$\leq 10\%$ ¹⁾											
Voltage drop V_d	$\leq 1.2\text{ V}$ ²⁾											
Power consumption	$\leq 10\text{ mA}$ ³⁾											
Continuous current I_a	$\leq 200\text{ mA}$											
Time delay before availability t_v	$\leq 100\text{ ms}$											
Hysteresis H, of s_r	1 ... 15 %											
Repeatability R	$\leq 5\%$ (U_b and T_a constant) ⁴⁾											
Temperature drift, of s_r	$\pm 10\%$											
EMC	According to EN 60947-5-2											
Switching output	PNP											
	NPN											
Output function	Normally open											
	Normally closed											
Installation	Non-flush											
Connection type	Connector, M12, 4-pin											
	Cable, PVC, 2 m											
Enclosure rating	IP 67 ⁵⁾											
Max. switching frequency	1,000 Hz											
Dimensions	M12 x 1 ⁶⁾											
Short circuit protection	✓ ⁷⁾											
Reverse polarity protection	✓											
Power-up pulse suppression	✓											
Shock/vibration stress	30 g, 11 ms/10 ... 55 Hz, 1 mm											
Ambient operating temperature T_a	-25 °C ... +70 °C											
Housing material	Brass nickel-plated, plastic											
Tightening torque	10 Nm											

¹⁾ of U_b
²⁾ at I_a max

³⁾ without load
⁴⁾ of s_r

⁵⁾ according to EN 60529
⁶⁾ thread diameter x pitch (mm)

⁷⁾ (pulsed)

Order information

Type	Order no.
IM12-08NNO-ZW1	7 900 044
IM12-08NNS-ZW1	7 900 042
IM12-08NPO-ZW1	7 900 043
IM12-08NPS-ZW1	7 900 041
IM12-08NNS-ZC1	7 900 046
IM12-08NPO-ZC1	7 900 047
IM12-08NPS-ZC1	7 900 045

Sensing range
4 mm

Inductive sensor

- Enhanced sensing range
- High switching frequency
- Short-circuit protection (pulsed)
- Robust brass housing, nickel-plated with fine thread M12 x 1 mm
- Enclosure rating IP 67

Dimensional drawing

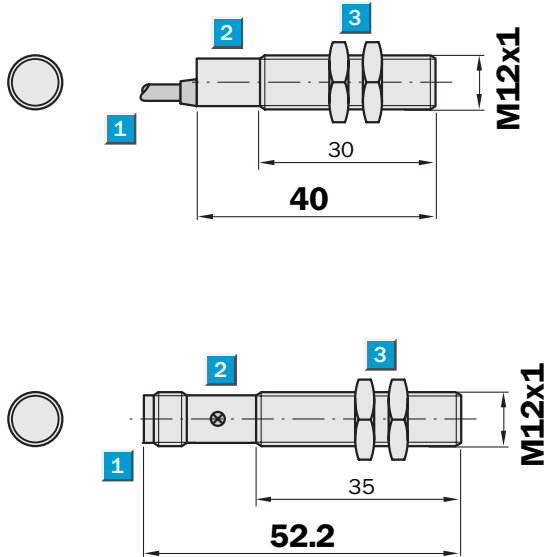

- 1 Connection
- 2 Display LED
- 3 Fastening nuts (2 x); width across 17, metal



Connection type

IM12-04BNS-ZWK	IM12-04BNS-ZCK	IM12-04BNO-ZCK
IM12-04BPS-ZWK	IM12-04BPS-ZCK	IM12-04BPO-ZCK

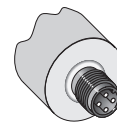
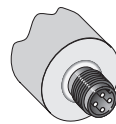
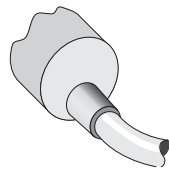

3 x 0.22 mm²

M12, 4-pin

M12, 4-pin

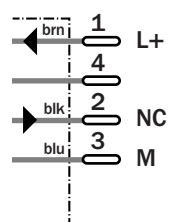
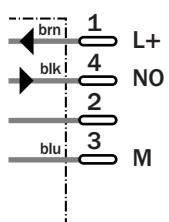
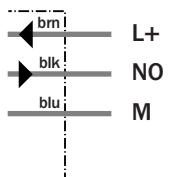

See chapter Accessories
Connector, M12, 4-pin
Mounting systems

Technical data		IM12-	04BNS-ZWK	04BPS-ZWK	04BNO-ZCK	04BNS-ZCK	04BPO-ZCK	04BPS-ZCK				
Sensing range S_n	4 mm											
Electrical configuration	DC 3-wire											
Supply voltage V_s	DC 10 ... 30 V											
Residual ripple V_{pp}	$\leq 10\%$ ¹⁾											
Voltage drop V_d	$\leq 1.5\text{ V}$ ²⁾											
Power consumption	$\leq 10\text{ mA}$ ³⁾											
Continuous current I_a	$\leq 300\text{ mA}$											
Time delay before availability t_v	$\leq 100\text{ ms}$											
Hysteresis H, of s_r	1 ... 15 %											
Repeatability R	$\leq 5\%$ (U_b and T_a constant) ⁴⁾											
Temperature drift, of s_r	$\pm 10\%$											
EMC	According to EN 60947-5-2											
Switching output	PNP											
	NPN											
Output function	Normally open											
	Normally closed											
Installation	Flush ⁵⁾											
Connection type	Connector, M12, 4-pin											
	Cable, PVC, 2 m											
Enclosure rating	IP 67 ⁶⁾											
Max. switching frequency	2,000 Hz											
Dimensions	M12 x 1 ⁷⁾											
Wire-break protection	✓											
Short circuit protection	✓ ⁸⁾											
Reverse polarity protection	✓											
Power-up pulse suppression	✓											
Shock/vibration stress	30 g, 11 ms/10 ... 55 Hz, 1 mm											
Ambient operating temperature T_a	-25 °C ... +75 °C											
Housing material	Brass nickel-plated, plastic											
Tightening torque	7 Nm											

¹⁾ of U_b
²⁾ at I_a max

³⁾ without load
⁴⁾ of s_r

⁵⁾ see installation notes
⁶⁾ according to EN 60529

⁷⁾ thread diameter x pitch (mm)
⁸⁾ (pulsed)

Order information

Type	Order no.
IM12-04BNS-ZWK	6 025 683
IM12-04BPS-ZWK	6 025 682
IM12-04BNO-ZCK	6 025 859
IM12-04BNS-ZCK	6 025 681
IM12-04BPO-ZCK	6 025 680
IM12-04BPS-ZCK	6 025 679

Sensing range
8 mm

Inductive sensor

- Enhanced sensing range
- High switching frequency
- Short-circuit protection (pulsed)
- Robust brass housing, nickel-plated with fine thread
- M12 x 1 mm
- Enclosure rating IP 67

Dimensional drawing

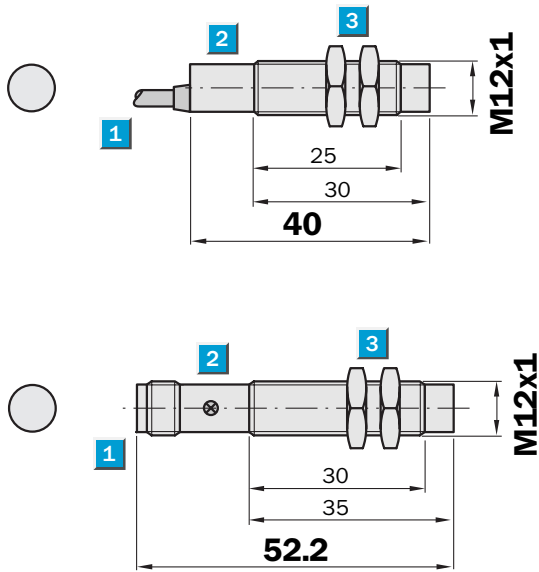

- 1 Connection
- 2 Display LED
- 3 Fastening nuts (2 x); width across 17, metal



Connection type

IM12-08NNS-ZWK	IM12-08NNS-ZCK	IM12-08NNO-ZCK
IM12-08NPS-ZWK	IM12-08NPS-ZCK	IM12-08NPO-ZCK

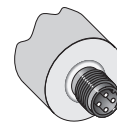
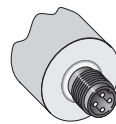
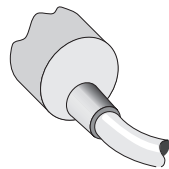

3 x 0.22 mm²

M12, 4-pin

M12, 4-pin

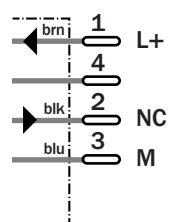
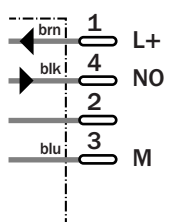
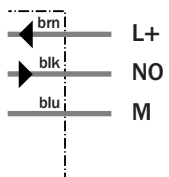

See chapter Accessories
Connector, M12, 4-pin
Mounting systems

Technical data		IM12-	08NNS-ZWK	08NPS-ZWK	08NNS-ZCK	08NNO-ZCK	08NPO-ZCK	08NPS-ZCK				
Sensing range S_n	8 mm											
Electrical configuration	DC 3-wire											
Supply voltage V_s	DC 10 ... 30 V											
Residual ripple V _{pp}	≤ 10 % ¹⁾											
Voltage drop V _d	≤ 1.5 V ²⁾											
Power consumption	≤ 10 mA ³⁾											
Continuous current I_a	≤ 300 mA											
Time delay before availability t _v	≤ 100 ms											
Hysteresis H, of s _r	1 ... 15 %											
Repeatability R	≤ 5 % (U _b and T _a constant) ⁴⁾											
Temperature drift, of s _r	± 10 %											
EMC	According to EN 60947-5-2											
Switching output	PNP											
	NPN											
Output function	Normally open											
	Normally closed											
Installation	Non-flush											
Connection type	Connector, M12, 4-pin											
	Cable, PVC, 2 m											
Enclosure rating	IP 67 ⁵⁾											
Max. switching frequency	2,000 Hz											
Dimensions	M12 x 1 ⁶⁾											
Wire-break protection	✓											
Short circuit protection	✓ ⁷⁾											
Reverse polarity protection	✓											
Power-up pulse suppression	✓											
Shock/vibration stress	30 g, 11 ms/10 ... 55 Hz, 1 mm											
Ambient operating temperature T _a	-25 °C ... +75 °C											
Housing material	Brass nickel-plated, plastic											
Tightening torque	7 Nm											

¹⁾ of U_b
²⁾ at I_a max

³⁾ without load
⁴⁾ of s_r

⁵⁾ according to EN 60529
⁶⁾ thread diameter x pitch (mm)

⁷⁾ (pulsed)

Order information	
Type	Order no.
IM12-08NNS-ZWK	6 025 685
IM12-08NPS-ZWK	6 025 684
IM12-08NNS-ZCK	6 025 687
IM12-08NNO-ZCK	6 025 860
IM12-08NPO-ZCK	6 025 688
IM12-08NPS-ZCK	6 025 686

Sensing range
6 / 10 mm

Inductive sensor

- Triple sensing range
- Installation quasi flush or non-flush in metal
- High switching frequency
- Short-circuit protection (pulsed)
- Robust brass housing, chrome-plated with fine thread
- M12 x 1 mm
- Enclosure rating IP 67



Dimensional drawing

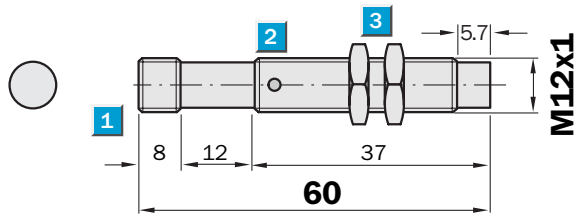
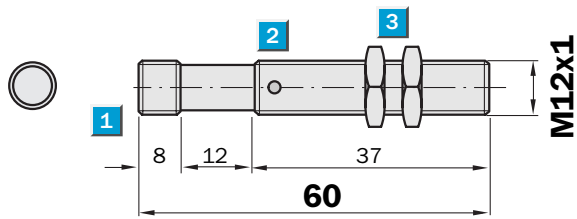
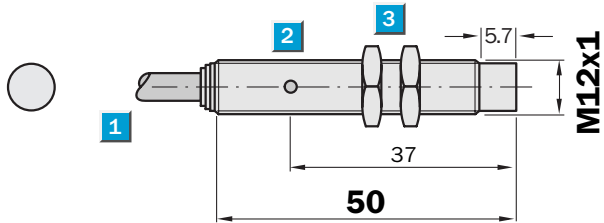
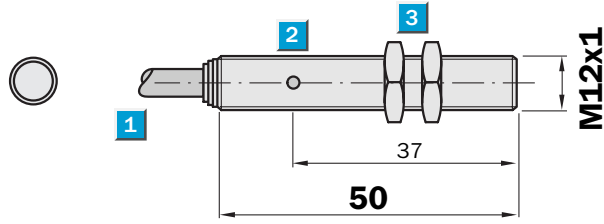

- 1 Connection
- 2 Display LED
- 3 Fastening nuts (2 x); width across 17, metal



Connection type

IM12-06BPO-ZW1	IM12-06BPS-ZC1
IM12-06BPS-ZW1	IM12-10NPS-ZC1
IM12-10NNS-ZW1	
IM12-10NPS-ZW1	

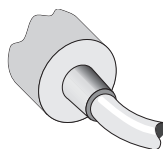

3 x 0.34 mm²

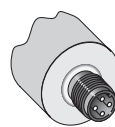
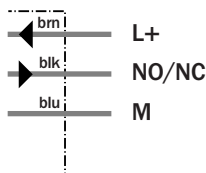

M12, 4-pin

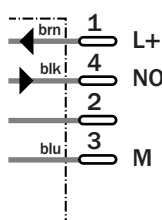

See chapter Accessories
Connector, M12, 4-pin
Mounting systems

Technical data		IM12-	06BPO-ZW1	06BPS-ZW1	06BPS-ZC1	10NNS-ZW1	10NPS-ZW1	10NPS-ZC1				
Sensing range S_n	10 mm											
	6 mm											
Electrical configuration	DC 3-wire											
Supply voltage V_s	DC 10 ... 30 V											
Residual ripple V _{pp}	≤ 10 % ¹⁾											
	≤ 20 % ¹⁾											
Voltage drop V _d	≤ 2 V ²⁾											
Power consumption	≤ 10 mA ³⁾											
Continuous current I_a	≤ 200 mA											
Time delay before availability t _v	≤ 100 ms											
Hysteresis H, of s _r	1 ... 15 %											
Repeatability R	≤ 5 % (U _b and T _a constant) ⁴⁾											
Temperature drift, of s _r	± 10 %											
EMC	According to EN 60947-5-2											
Switching output	PNP											
	NPN											
Output function	Normally open ⁵⁾											
	Normally closed ⁵⁾											
Installation	Non-flush											
	Quasi-flush ⁶⁾											
Connection type	Connector, M12, 4-pin											
	Cable, PVC, 2 m											
Enclosure rating	IP 67 ⁷⁾											
Max. switching frequency	400 Hz											
	800 Hz											
Dimensions	M12 x 1 ⁸⁾											
Short circuit protection	✓ ⁹⁾											
Reverse polarity protection	✓											
Power-up pulse suppression	✓											
Shock/vibration stress	30 g, 11 ms/10 ... 55 Hz, 1 mm											
Ambient operating temperature T _a	-25 °C ... +75 °C											
Housing material	Brass, chrome-plated, plastic											
Tightening torque	10 Nm											

¹⁾ of U_b
²⁾ at I_a max
³⁾ without load

⁴⁾ of s_r
⁵⁾ other output functions available on request.

⁶⁾ when mounting in conductible materials the sensors must be installed with a distance A to the surface. A Steel, metal =

2 mm/A Stainless steel = 1 mm according to EN 60529
⁸⁾ thread diameter x pitch (mm)
⁹⁾ (pulsed)

Order information	
Type	Order no.
IM12-06BPO-ZW1	6 027 510
IM12-06BPS-ZW1	6 027 509
IM12-06BPS-ZC1	6 027 511
IM12-10NNS-ZW1	6 027 513
IM12-10NPS-ZW1	6 027 512
IM12-10NPS-ZC1	6 027 514

Sensing range
6 / 10 mm

Inductive sensor

- Triple sensing range
- Installation flush or non-flush in metal
- Robust stainless steel V4A, 316L one piece housing, with fine thread M12 x 1 mm
- Enclosure rating IP 69K
- Especially suitable for use in the food and beverage sector

Dimensional drawing

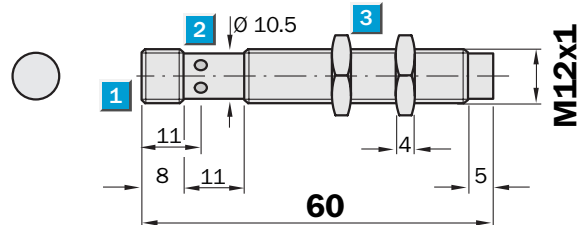
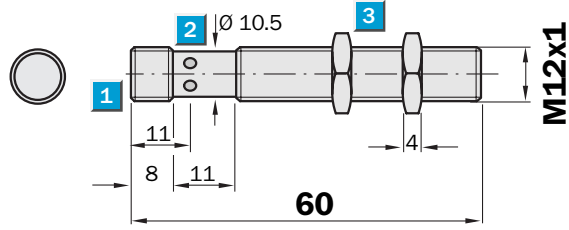

- 1 Connection
- 2 Display LED
- 3 Fastening nuts (2 x); width across 17, stainless steel V4A, 316L



Connection type

IM12-06BPO-NC1

IM12-06BNS-NC1

IM12-06BPS-NC1

IM12-10NNS-NC1

IM12-10NPS-NC1

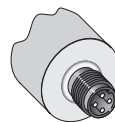
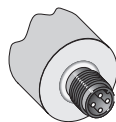

See chapter Accessories

Connector, M12, 4-pin

M12, 4-pin

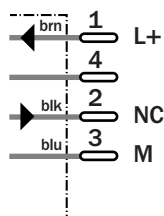

M12, 4-pin

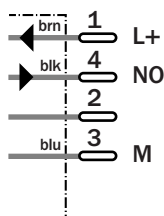

Technical data		IM12-	06BNS-NC1	06BPO-NC1	06BPS-NC1	10NNS-NC1	10NPS-NC1						
Sensing range S_n	10 mm												
	6 mm												
Electrical configuration	DC 3-wire												
Supply voltage V_s	DC 10 ... 30 V												
Ripple V_{pp}	$\leq 20\%$ ¹⁾												
Voltage drop V_d	$\leq 2\text{ V}$ ²⁾												
Current consumption	$\leq 15\text{ mA}$ ³⁾												
Continuous current I_a	$\leq 200\text{ mA}$												
Time delay before availability t_v	$\leq 80\text{ ms}$												
Hysteresis H (of s_r)	1 ... 15 %												
Repeatability R	$\leq 5\%$ (U_b and T_a constant) ⁴⁾												
Temperature drift, of s_r	$\pm 10\%$												
EMC	According to EN 60 947-5-2												
Switching output	PNP												
	NPN												
Output function	Normally open ⁵⁾												
	Normally closed ⁵⁾												
Installation	Non-flush ⁶⁾												
	Flush												
Connection types	Plug, M12, 4-pin												
Enclosure rating	IP 69K												
Max. switching frequency	400 Hz												
Dimensions	M12 x 1 ⁷⁾												
Short-circuit protection	✓ ⁸⁾												
Reverse polarity protection	✓												
Power-up pulse suppression	✓												
Shock / vibration stress	30 g, 11 ms / 10 ... 55 Hz, 1 mm												
Ambient temperature T_a	-25 °C ... +75 °C												
Housing material	Stainless steel V4A, 316L												
Tightening material	10 Nm												

¹⁾ of U_b
²⁾ at I_a max

³⁾ without load
⁴⁾ of s_r

⁵⁾ other output functions available on request

⁶⁾ see installation notes
⁷⁾ thread diameter x pitch (mm)
⁸⁾ (pulsed)

Correction factors:

	Flush installation:	Non-flush installation:
Steel (ST37)	1.0	1.0
Copper	0.85	0.8
Aluminium	1.0	1.0
Brass	1.3	1.3
Stainless steel	0.45 / 0.9	0.5 / 0.9

1 mm / 2 mm thick

Order information

Type	Order no.
IM12-06BNS-NC1	6 027 573
IM12-06BPO-NC1	6 027 574
IM12-06BPS-NC1	6 027 572
IM12-10NNS-NC1	6 027 576
IM12-10NPS-NC1	6 027 575

Sensing range
2 / 4 mm

Inductive sensor

- For harsh environment, resistant to most cutting oils
- Enclosure rating IP 68
- Complementary output function
- Robust brass housing, nickel-plated with fine thread
- M12 x 1 mm
- LED status indicator (NO function)

Dimensional drawing

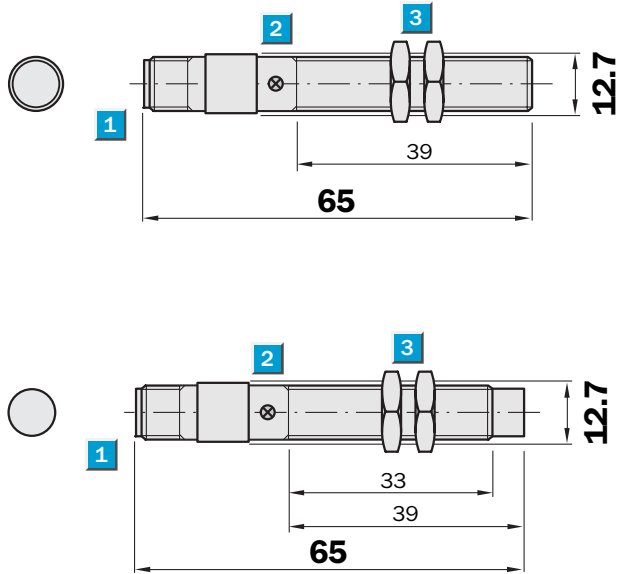

- 1 Connection
- 2 Display LED
- 3 Fastening nuts (2 x); width across 17, metal



Connection type

- IM12-02BNP-ZC1
- IM12-02BPP-ZC1
- IM12-04NPP-ZC1
- IM12-04NPP-ZC1

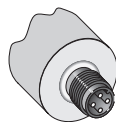

M12, 4-pin

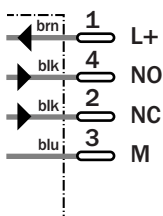

See chapter Accessories

Connector, M12, 4-pin

Mounting systems

Technical data		IM12-	02BNP -ZC1	02BPP -ZC1	04NNP -ZC1	04NPP -ZC1						
Sensing range S_n	4 mm											
	2 mm											
Electrical configuration	DC 4-wire											
Supply voltage V_s	DC 10 ... 30 V											
Residual ripple V_{pp}	$\leq 10\%$ ¹⁾											
Voltage drop V_d	$\leq 1.2\text{ V}$ ²⁾											
Power consumption	$\leq 20\text{ mA}$ ³⁾											
Continuous current I_a	$\leq 100\text{ mA}$											
Time delay before availability t_v	$\leq 100\text{ ms}$											
Hysteresis H, of s_r	2 ... 10 %											
Repeatability R	$\leq 5\%$ (U_b and T_a constant) ⁴⁾											
Temperature drift, of s_r	$\pm 10\%$											
EMC	According to EN 60947-5-2											
Switching output	PNP											
	NPN											
Output function	Complementary											
Installation	Non-flush											
	Flush											
Connection type	Connector, M12, 4-pin											
Enclosure rating	IP 68											
Max. switching frequency	2,000 Hz											
Dimensions	M12 x 1 ⁵⁾											
Short circuit protection	✓ ⁶⁾											
Reverse polarity protection	✓											
Power-up pulse suppression	✓											
Shock/vibration stress	30 g, 11 ms/10 ... 55 Hz, 1 mm											
Ambient operating temperature T_a	-25 °C ... +70 °C											
Housing material	Brass nickel-plated, plastic											
Tightening torque	10 Nm											

¹⁾ of U_b
²⁾ at I_a max

³⁾ without load
⁴⁾ of s_r

⁵⁾ thread diameter x pitch (mm)
⁶⁾ (pulsed)

Order information

Type	Order no.
IM12-02BNP-ZC1	7 902 924
IM12-02BPP-ZC1	7 902 923
IM12-04NNP-ZC1	7 902 926
IM12-04NPP-ZC1	7 902 925

Sensing range
2 / 4 mm

Inductive sensor

- Free configurable output functions in one sensor PNP/NO, PNP/NC NPN/NO, NPN/NC
- Short-circuit protection
- Robust brass housing, nickel-plated with fine thread M12 x 1 mm
- Enclosure rating IP 67
- LED status indicator (NO function)

Dimensional drawing

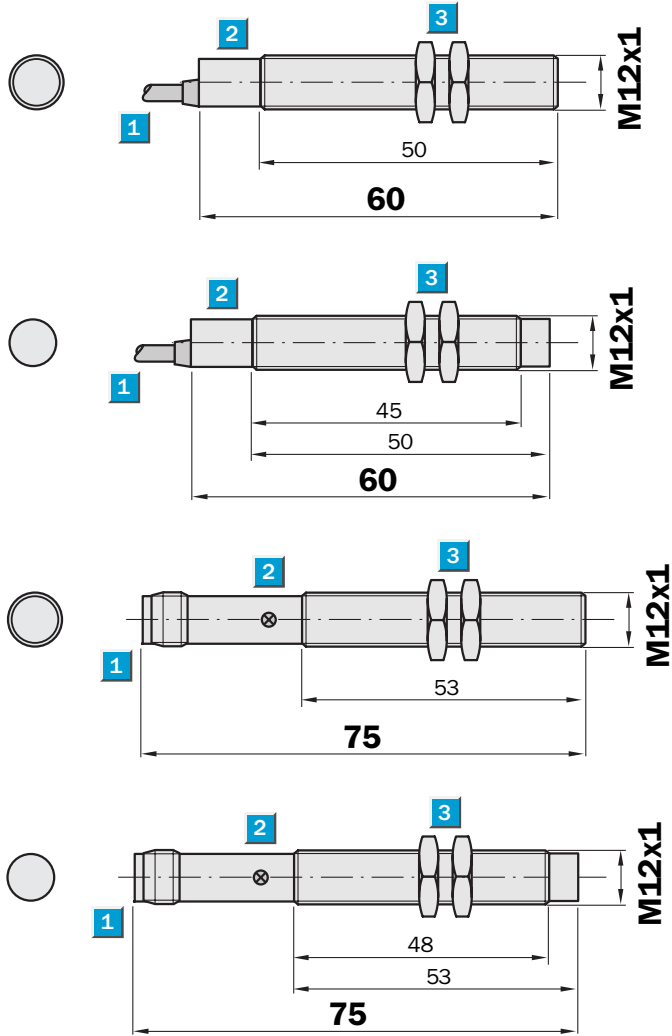

- 1 Connection
- 2 Display LED
- 3 Fastening nuts (2 x); width across 17, metal

Connection type

IM12-02BCP-ZW1
IM12-04NCP-ZW1

IM12-02BCP-ZC1
IM12-04NCP-ZC1

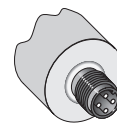
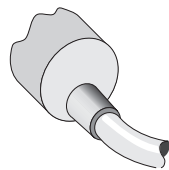

4 x 0.22 mm²
PNP version

NPN version

M12, 4-pin
PNP version

NPN version

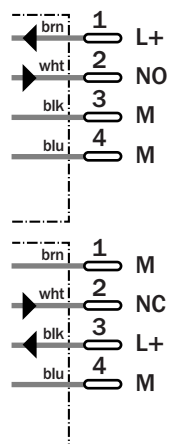
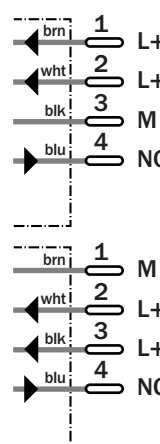
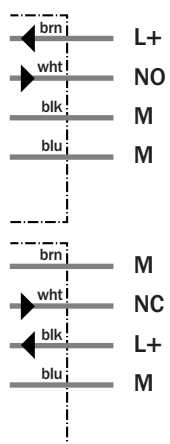
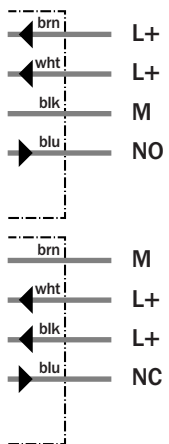

See chapter Accessories
Connector, M12, 4-pin
Mounting systems

Technical data		IM12-	02BCP -ZW1	02BCP -ZC1	04NCP -ZW1	04NCP -ZC1						
Sensing range S_n	4 mm											
	2 mm											
Electrical configuration	DC 4-wire											
Supply voltage V_s	DC 10 ... 30 V											
Residual ripple V_{pp}	$\leq 10\%$ ¹⁾											
Voltage drop V_d	$\leq 1.2\text{ V}$ ²⁾											
Power consumption	$\leq 30\text{ mA}$ ³⁾											
Continuous current I_a	$\leq 100\text{ mA}$											
Time delay before availability t_v	$\leq 250\text{ ms}$											
Hysteresis H, of s_r	2 ... 10 %											
Repeatability R	$\leq 5\%$ (U_b and T_a constant) ⁴⁾											
Temperature drift, of s_r	$\pm 10\%$											
EMC	According to EN 60947-5-2											
Switching output	PNP/NPN config.											
Output function	Configurable											
Installation	Non-flush											
	Flush											
Connection type	Connector, M12, 4-pin											
	Cable, PVC, 2 m											
Enclosure rating	IP 67 ⁵⁾											
Max. switching frequency	1,000 Hz											
Dimensions	M12 x 1 ⁶⁾											
Short circuit protection	✓											
Reverse polarity protection	✓											
Power-up pulse suppression	✓											
Shock/vibration stress	30 g, 11 ms/10 ... 55 Hz, 1 mm											
Ambient operating temperature T_a	-25 °C ... +70 °C											
Housing material	Brass nickel-plated, plastic											
Tightening torque	10 Nm											

¹⁾ of U_b
²⁾ at I_a max
³⁾ without load
⁴⁾ of s_r
⁵⁾ according to EN 60529
⁶⁾ thread diameter x pitch (mm)

Order information

Type	Order no.
IM12-02BCP-ZW1	7 902 927
IM12-02BCP-ZC1	7 902 928
IM12-04NCP-ZW1	7 902 929
IM12-04NCP-ZC1	7 902 930

Sensing range
2 / 4 mm

Inductive sensor

- Short-circuit protection (pulsed)
- Robust brass housing, nickel-plated with fine thread
M12 x 1 mm
- Enclosure rating IP 67
- High switching frequency



Dimensional drawing

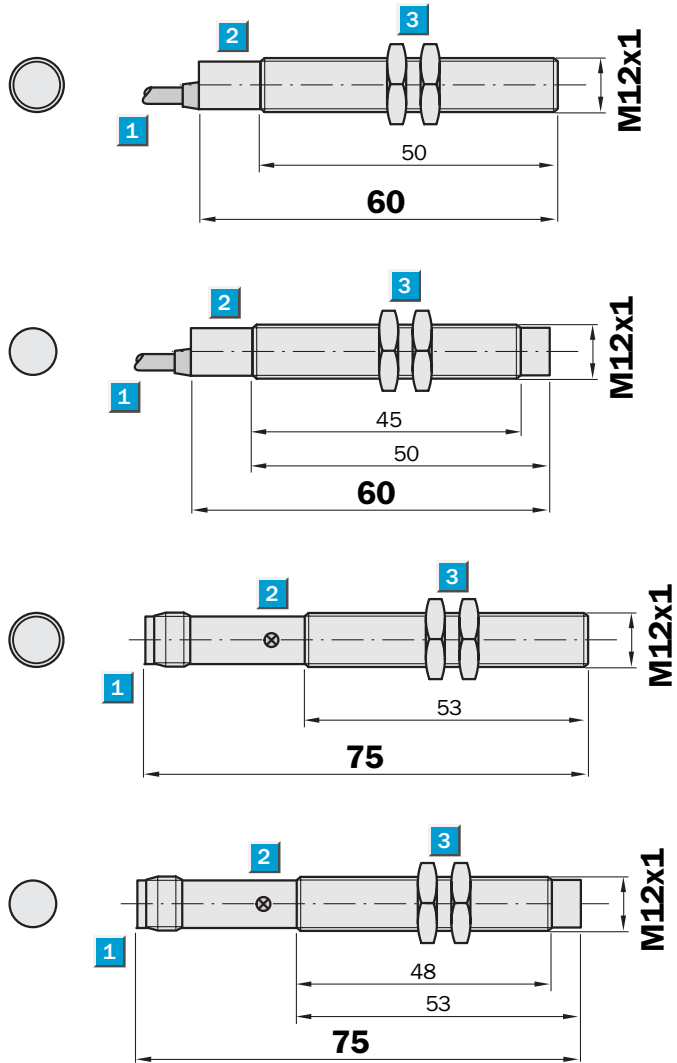

- 1 Connection
- 2 Display LED
- 3 Fastening nuts (2 x); width across 17, metal



Connection type

IM12-02BDS-ZW1
IM12-04NDS-ZW1

IM12-02BDS-ZC1
IM12-04NDS-ZC1

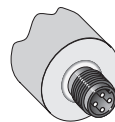
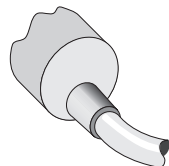

2 x 0.22 mm²

M12, 4-pin

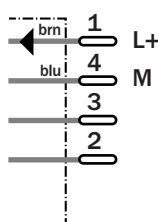
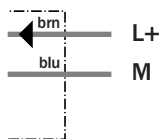

See chapter Accessories

Connector, M12, 4-pin

Mounting systems

Technical data		IM12-	02BDS -ZC1	02BDS -ZW1	04NDS -ZC1	04NDS -ZW1						
Sensing range S_n	4 mm											
	2 mm											
Electrical configuration	DC 2-wire											
Supply voltage V_s	DC 10 ... 30 V											
Residual ripple V_{pp}	$\leq 10\%$											
Voltage drop V_d	$\leq 2.8\text{ V}^{1)}$											
Continuous current I_a	$\leq 100\text{ mA}$											
Min. load current	$\geq 3\text{ mA}$											
Residual current	$\leq 0.8\text{ mA}$											
Time delay before availability t_v	$\leq 50\text{ ms}$											
Hysteresis H, of s_r	2 ... 10 %											
Repeatability R	$\leq 5\%$ (U_b and T_a constant) ²⁾											
Temperature drift, of s_r	$\pm 10\%$											
EMC	According to EN 60947-5-2											
Output function	Normally open ³⁾											
Installation	Non-flush											
	Flush											
Connection type	Cable, PVC, 2 m											
	Connector, M12, 4-pin											
Enclosure rating	IP 67 ⁴⁾											
Max. switching frequency	1,500 Hz											
Dimensions	M12 x 1 ⁵⁾											
Short circuit protection	✓ ⁶⁾											
Reverse polarity protection	✓											
Shock/vibration stress	30 g, 11 ms/10 ... 55 Hz, 1 mm											
Ambient operating temperature T_a	-25 °C ... +70 °C											
Housing material	Brass nickel-plated, plastic											
Tightening torque	10 Nm											

¹⁾ at I_a max
²⁾ of s_r

³⁾ normally closed function available on request

⁴⁾ according to EN 60529
⁵⁾ thread diameter x pitch (mm)

⁶⁾ (pulsed)

Order information

Type	Order no.
IM12-02BDS-ZC1	6 020 312
IM12-02BDS-ZW1	6 020 310
IM12-04NDS-ZC1	6 020 316
IM12-04NDS-ZW1	6 020 314

Sensing range
2 / 4 mm

Inductive sensor

- Broad supply voltage range in AC
- Robust brass housing, nickel-plated, with fine thread M12 x 1 mm
- Enclosure rating IP 67

Dimensional drawing

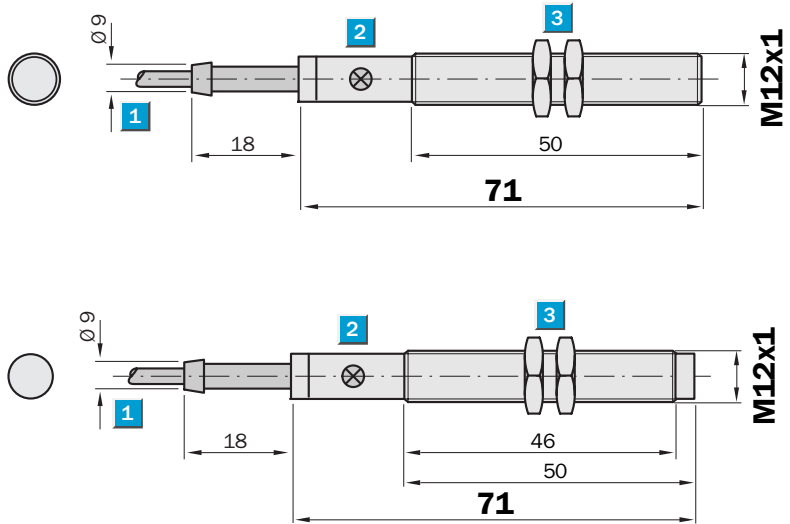

- 1 Connection
- 2 Display LED
- 3 Fastening nuts (2 x); width across 17, metal



Connection type

- IM12-02BAO-ZUO
- IM12-02BAS-ZUO
- IM12-04NAO-ZUO
- IM12-04NAS-ZUO

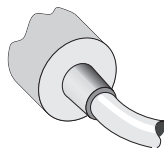

2 x 0.5 mm²

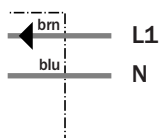

See chapter Accessories
Mounting systems

Technical data		IM12-	02BA0 -ZU0	02BAS -ZU0	04NAO -ZU0	04NAS -ZU0						
Sensing range S_n	4 mm											
	2 mm											
Electrical configuration	AC 2-wire											
Supply voltage V_s	AC 20 ... 250 V											
Voltage drop V_d	≤ 8.5 V ¹⁾											
Continuous current I_a	≤ 250 mA (... + 50 °C)											
	≤ 200 mA (... + 80 °C)											
Short duration current I_k	0.9 A (20 ms/0.5 Hz)											
Min. load current	8 mA											
Residual current	≤ 3 mA (250 V AC)											
	≤ 1.5 mA (120 V AC)											
Time delay before availability t_v	≤ 10 ms											
Hysteresis H, of s_r	1 ... 15 %											
Repeatability R	≤ 10 % (U_b and T_a constant) ²⁾											
Temperature drift, of s_r	± 10 %											
EMC	According to EN 60947-5-2											
Output function	Normally open											
	Normally closed											
Installation	Non-flush											
	Flush											
Connection type	Cable, PUR-PVC, 2 m											
Enclosure rating	IP 67 ³⁾											
VDE protection class	<input type="checkbox"/>											
Max. switching frequency	25 Hz											
Dimensions	M12 x 1 ⁴⁾											
Wire-break protection	-											
Short circuit protection	-											
Reverse polarity protection	-											
Power-up pulse suppression	✓											
Shock/vibration stress	30 g, 11 ms/10 ... 55 Hz, 1 mm											
Ambient operating temperature T_a	-25 °C ... +80 °C											
Housing material	Brass nickel-plated, plastic											
Tightening torque	7 Nm											

¹⁾ at I_a max

²⁾ of s_r

³⁾ according to EN 60529

⁴⁾ thread diameter x pitch (mm)

Order information

Type	Order no.
IM12-02BA0-ZU0	7 902 119
IM12-02BAS-ZU0	7 902 118
IM12-04NAO-ZU0	7 902 121
IM12-04NAS-ZU0	7 902 120

	Sensing range 2 / 4 mm
	Inductive sensor

- NAMUR to EN 60 947-5-6
- Robust brass housing, nickel-plated, with fine thread M12 x 1 mm
- Classification PTB 03 ATEX 2037
 II 2 G EEx ia IIC T6

Dimensional drawing

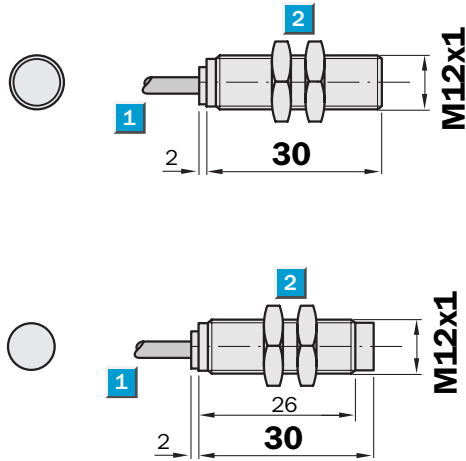

- 1** Connection
- 2** Fastening nuts (2 x); width across 17, metal

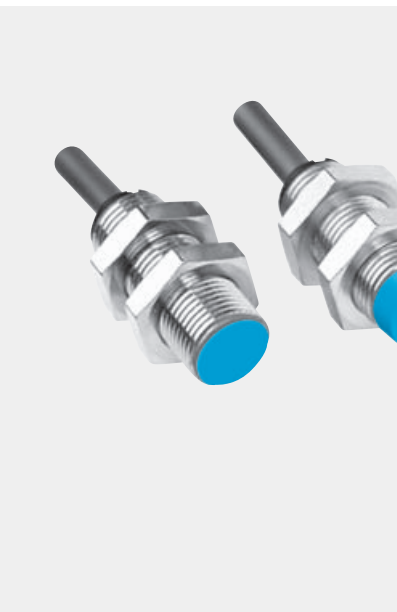

Connection type

- IM12-02B-N-ZWO
- IM12-04N-N-ZWO

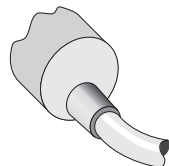

2 x 0.34 mm²

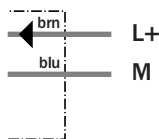

See chapter Accessories
 Mounting systems
 Switching units

Technical data		IM12-	02B-N-ZWO	04N-N-ZWO										
Sensing range S_n	4 mm													
	2 mm													
Electrical configuration	NAMUR													
Supply voltage V_s	DC 5 ... 25 V													
Nominal voltage V_n	DC 8.2 V													
Power consumption, attenuated	≤ 1 mA													
Power consumption, unattenuated	≥ 2.2 mA													
Internal capacitance	≤ 230 nF													
Internal inductance	≤ 380 μ H													
Cable resistance	≤ 50 Ohm													
Temperature drift, of s_r	± 10 %													
EMC	Accroding to EN 60 947-5-6													
Switching output	Control current dependent on switching ¹⁾													
Output function	NAMUR													
Installation	Non-flush													
	Flush													
Connection type	Cable, PVC, 2 m													
Enclosure rating	IP 67 ²⁾													
Max. switching frequency	1,500 Hz													
	1,200 Hz													
Dimensions	M12 x 1 ³⁾													
✓Short-circuit protected														
✓Reverse polarity protected														
Shock/vibration stress	30 g, 11 ms/10 ... 55 Hz, 1 mm													
Ambient operating temperature T_a	-25 °C ... +70 °C													
Housing material	Brass nickel-plated, plastic													
Tightening torque	7 Nm													

¹⁾ according to NAMUR EN 60947-5-6

²⁾ according to EN 60529

³⁾ thread diameter x pitch (mm)

Max. data for connecting Isolating unit EN 2 EX

or other approved isolating amplifier:

Short circuit current I_{Kmax}	50 mA
No load voltage U_0	16 V
Power loss P_{max}	75 mW

Order information

Type	Order no.
IM12-02B-N-ZWO	6 021 124
IM12-04N-N-ZWO	6 021 125

X-ON Electronics

Largest Supplier of Electrical and Electronic Components

Click to view similar products for [Proximity Sensors](#) category:

Click to view products by [Sick](#) manufacturer:

Other Similar products are found below :

[01.001.5653.1](#) [70.340.1028.0](#) [70.360.2428.0](#) [70.364.4828.0](#) [70.810.1053.0](#) [72.360.1628.0](#) [73.363.6428.0](#) [9221350022](#) [980659-1](#) [QT-12](#)
[E2EX10D1NN](#) [E2E-X14MD1-G](#) [E2E-X2D1-G](#) [E2EX2ME2N](#) [E2E-X3D1-N 10M](#) [E2E-X4MD1-G](#) [E2FMX1R5D12M](#) [E2K-F10MC1 5M](#)
[EI1204TBOSL-6](#) [EI5515NPAP](#) [BSA-08-25-08](#) [IC08ANC15PO-K](#) [IMM2582C](#) [25.161.3253.0](#) [25.332.0653.1](#) [25.352.0653.0](#) [25.352.0753.0](#)
[25.523.3253.0](#) [9151710023](#) [922FS1.5C-A4P-Z774](#) [SC606ABV0S30](#) [SM952A126100LE](#) [SM956A132600](#) [A1220EUA-T](#) [F3S-A162-U](#) [CL18](#)
[QT-08L](#) [34.110.0010.0](#) [TL-C2MF1-M3-E4](#) [IA08BLF15NOM5](#) [IA08BSF15NOM5](#) [IA12ASF04DOM1](#) [IMM32188C](#) [IS2](#) [IS31SE5000-](#)
[UTLS2-TR](#) [34.110.0021.0](#) [34.110.0022.0](#) [CA150-120VACDC](#) [VM18VA3000Q](#) [XS508BSCBL2](#)