



# SMART10 A/Z

## CONTINUOUS LINE OF LIGHT IN A SMALL OVERALL DIMENSIONS

### CIĄGŁA LINIA ŚWIATŁA W MAŁYM GABARYCIE



- decorative and lighting profile
- continuous line of light (when using LED strip 120 P/m and white cover)
- SLICK socket
- miniature dimensions
- universal application
- the possibility of using waterproof LED strips
- maximum width of LED strip: 10 mm
- profil dekoracyjno-oświetleniowy
- ciągła linia światła (przy zastosowaniu taśmy 120 P/m i klosza mlecznego)
- gniazdo SLICK
- miniaturowe gabaryty
- uniwersalne zastosowanie
- możliwość zastosowania taśm wodoodpornych
- maksymalna szerokość taśmy LED: 10 mm



## SIMILAR IN THE OFFER / PODOBNE W OFERCIE

SLIM8  
A/Z

SMART-IN10  
A/Z

SURFACE10  
BC/UX

BEGTON12  
J/S

SURFACE14  
EF/TY



# SMART10 A/Z

- A** slide cover  
klosz A wsuwany
- Z**<sup>1</sup> Z flexible mounting plate  
uchwyt Z sprężysty
- Z**<sup>2</sup> cone Z flexible mounting plate  
uchwyt Z sprężysty cone

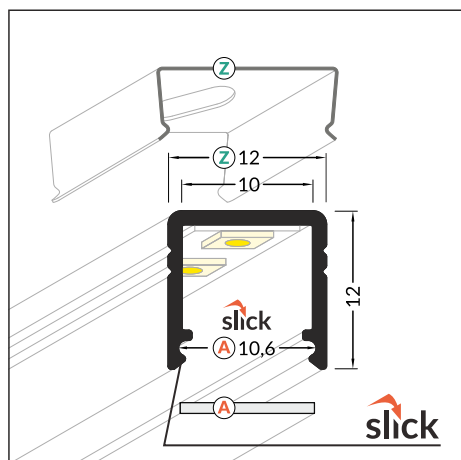
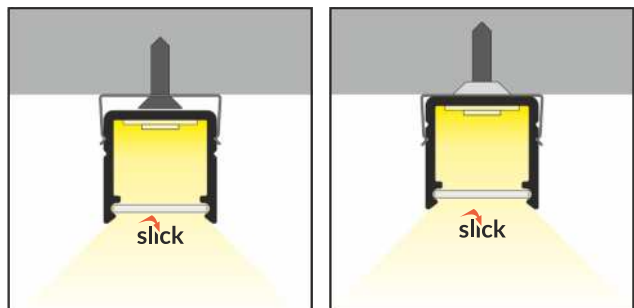
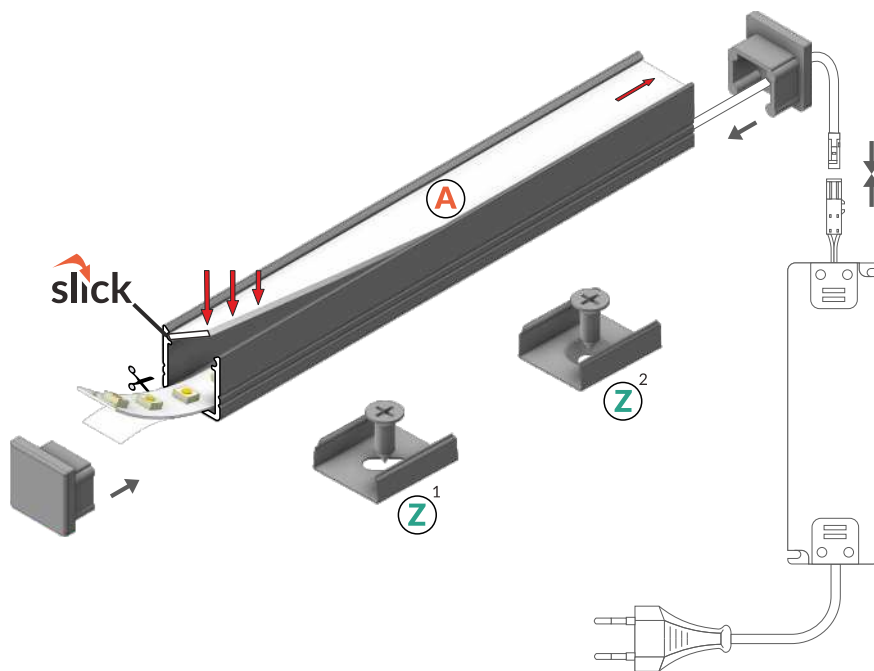

max 10 mm



surface  
nawierzchniowy



INDEX = 1 pc, length 2000 mm  
package = 10 pcs  
INDEKS = 1 szt., długość 2000 mm  
opakowanie = 10 szt.



white painted  
biały malowany  
C2020001



anodized  
anodowany  
C2020020



black anodized  
czarny anodowany  
C2020021



raw aluminium  
surowe aluminium  
C2020000

Available lengths / Dostępne długości  
1000 mm, 2000 mm, 3000 mm, 4000 mm



## COVERS / KLOSZE

**A slide cover**  
colours: transparent, frosted, white  
material: PC, PP, PP

klosz **A** wsuwany  
kolory: transparentny, szron, mleczny  
materiał: PC, PP, PP

**Note!** Dimensions of the space to install LED source  
**Uwaga!** Wymiary przestrzeni do zamontowania źródła LED

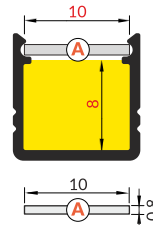

INDEX = 1 pc, length 2000 mm  
package = 10 pcs  
INDEKS = 1 szt., długość 2000 mm  
opakowanie = 10 szt.

**A transparent / A transparentny**  
89070016

**A frosted / A szron**  
89070039

**A white / A mleczny**  
89070038

## ENDINGS / ZAŚLEPKI

**SMART10 ending**  
colours: white, silver, black, grey  
material: ABS

zaślepka SMART10  
kolory: biały, srebrny, czarny, szary  
materiał: ABS

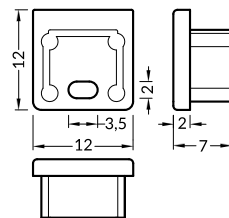

**SMART10 ending with hole**  
colours: white, silver, black, grey  
material: ABS

zaślepka SMART10 z otworem  
kolory: biały, srebrny, czarny, szary  
materiał: ABS

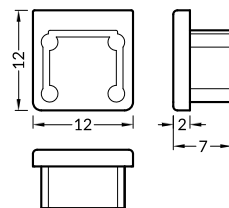

INDEX = 1 set  
package of 10 sets = 20 pcs  
INDEKS = 1 komplet, opakowanie  
zawiera 10 kompletów = 20 szt.

**white / białe**  
without hole bez otworu | with hole z otworem  
C2940001 | C2960001

**silver / srebrne**  
without hole bez otworu | with hole z otworem  
C2940040 | C2960040

**black / czarne**  
without hole bez otworu | with hole z otworem  
C2940002 | C2960002

**grey / szare**  
without hole bez otworu | with hole z otworem  
C2940022 | C2960022

## MOUNTINGS / MOCOWANIA

**Z flexible mounting plate**  
colours: white, inox, black  
material: stainless steel

uchwyt **Z** sprężysty  
kolory: biały, inox, czarny  
materiał: stal nierdzewna

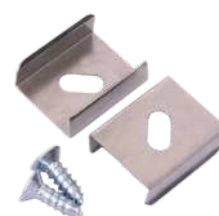
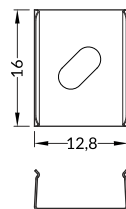
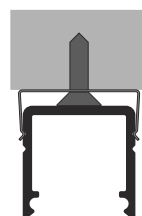

INDEX = 1 set  
package of 10 sets = 20 pcs  
INDEKS = 1 komplet  
opakowanie zawiera 10 kpl = 20 szt.

**Z flexible mounting plate**  
uchwyt **Z** sprężysty

**white biały** 89270001

**inox inox** 89270019

**black czarny** 89270002

**cone Z flexible mounting plate**  
colours: white, inox, black  
material: stainless steel

uchwyt **Z** sprężysty cone  
kolory: biały, inox, czarny  
materiał: stal nierdzewna

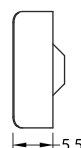
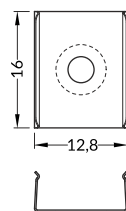
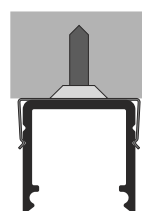

**cone Z flexible mounting plate**  
uchwyt **Z** sprężysty cone

**white biały** 89980001

**inox inox** 89980019

**black czarny** 89980002



## CONNECTORS / ŁĄCZNIKI

**SMART10 connector 90 deg**  
colours: white, anodized, black  
material: aluminium

łącznik SMART10 90 st  
kolory: biały, anodowany, czarny  
materiał: aluminium

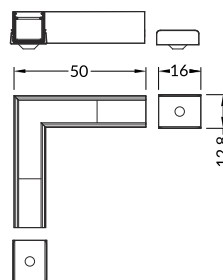

INDEX = 1 set  
INDEKS = 1 komplet

-  white painted  
biały malowany  
**C2910001**
-  anodized  
anodowany  
**C2910020**
-  black anodized  
czarny anodowany  
**C2910021**



Made in Poland  
Wyprodukowane w Polsce



EU-registered industrial design  
Wzory przemysłowe EU

TOPMET LIGHT Kłósowicz Wiśniewski i Wspólnik Sp. j. ADDRESS: Ostrowska 354, 61-312 Poznań, POLAND  
tel. +48 61 87 27 500, fax. +48 61 87 27 518 [biuro@topmet.pl](mailto:biuro@topmet.pl), [www.topmet.pl](http://www.topmet.pl)

The catalogue is not an offer under Polish Civil Code regulations. Colours of particular products may vary slightly from colours shown in pictures. The dimensions given are approximate and can not be a reason for complaint. TOPMET Company reserves the right to make technical changes.  
Folder nie stanowi oferty w myśl przepisów Kodeksu Cywilnego. Aktualną ofertę firmy stanowi cennik. Kolory poszczególnych produktów mogą się nieznacznie różnić od kolorów prezentowanych na zdjęciach. Podane wymiary są wymiarami orientacyjnymi i nie mogą stanowić podstawy reklamacji. Firma TOPMET zastrzega sobie prawo do wprowadzania zmian technicznych.

brochure designer • proj. folderu: M. Kędziora, A. Szafran 11.2016. photo • fot. A. Szafran, L. Wesołowski

# X-ON Electronics

Largest Supplier of Electrical and Electronic Components

*Click to view similar products for [LED Lighting Mounting Accessories](#) category:*

*Click to view products by [Topmet](#) manufacturer:*

Other Similar products are found below :

[3635](#) [PALBF18](#) [C16142\\_HEKLA-SOCKET-K](#) [3SU1900-0BC31-0AA0](#) [3SU1900-0BC31-0NB0](#) [2213118-2](#) [47.319.6380.50](#) [3SU1401-2BB40-1AA0](#) [3SU1401-2BB60-1AA0](#) [1SFA611621R1041](#) [23110040](#) [23120022](#) [23130000](#) [68550022](#) [68550040](#) [70290000](#) [70290022](#) [70290040](#) [70300022](#) [70300040](#) [76620000](#) [76990022](#) [77280022](#) [77980022](#) [77990001](#) [77990002](#) [77990040](#) [83130001](#) [83130040](#) [83150001](#) [83150022](#) [83150040](#) [83980001](#) [83980040](#) [83990001](#) [83990022](#) [83990040](#) [84040022](#) [84510002](#) [86050038](#) [86180003](#) [89080002](#) [89080022](#) [89140002](#) [89980002](#) [89980019](#) [98050040](#) [A1070001](#) [A1070002](#) [A2070001](#)