

## 6 - Control, timing & monitoring relays



### Control relays.....6.1 - 6.38

|   |             |
|---|-------------|
| Features and benefits .....                                     | 6.1         |
| <b>General information</b>                                      |             |
| Panorama .....  | 6.2 - 6.3   |
| Technical terms and definitions.....                            | 6.4         |
| IEC Standards, utilization categories .....                     | 6.5         |
| Pilot duty ratings and overload trip classes.....               | 6.6         |
| NF/NFZ control relays .....                                     | 6.7         |
| <b>Selection</b>  |             |
| NF, 4 & 8 pole .....  | 6.8         |
| NFZ, 4 & 8 pole.....  | 6.9         |
| NS/NSL 4 & 8 pole .....   | 6.10        |
| NS/NSL 4 & 8 pole, spring terminated .....                      | 6.11        |
| K6 miniature, 4 pole .....                                      | 6.12        |
| KC6 miniature, 4 pole .....                                     | 6.13        |
| KC6 interface relays, 4 pole .....                              | 6.14        |
| <b>Accessory fitting details</b>                                |             |
| NF(Z), 4 & 8 pole.....  | 6.15        |
| NS/L 4 & 8 pole, screw terminated.....                          | 6.16        |
| NS/L 4 & 8 pole, spring terminated .....                        | 6.17        |
| <b>Accessories</b>  |             |
| Auxiliary contact blocks & interlocks.....                      | 6.18        |
| Surge suppression for control relay coils .....                 | 6.19        |
| Electronic timers .....   | 6.20        |
| Function markers, protective covers & coil terminal blocks..... | 6.21        |
| Terminal marking & positioning.....                             | 6.22 - 6.25 |
| Technical data .....  | 6.26 - 6.37 |

### Timers & monitors .....6.39 - 6.298

|  |               |
|--|---------------|
| <b>General information</b>                       |               |
| Overview.....                                    | 6.40          |
| Approvals and marks .....                        | 6.41          |
| <b>CT-D Range timers</b>                         |               |
| Benefits and advantages.....                     | 6.44          |
| Ordering details.....                            | 6.45          |
| Function diagrams .....                          | 6.46 - 6.48   |
| Connection diagrams.....                         | 6.49          |
| Technical data & diagrams .....                  | 6.50 - 6.52   |
| Approximate dimensions.....                      | 6.53          |
| <b>CT-E Range timers</b>                         |               |
| Benefits and advantages.....                     | 6.56          |
| Ordering details.....                            | 6.57 - 6.58   |
| Function diagrams .....                          | 6.59 - 6.63   |
| Connection diagrams.....                         | 6.64          |
| Technical data & diagrams .....                  | 6.65 - 6.67   |
| Approximate dimensions.....                      | 6.68          |
| <b>CT-S Range timers</b>                         |               |
| Benefits and advantages.....                     | 6.70          |
| Conversion table.....                            | 6.71          |
| Ordering details.....                            | 6.72 - 6.74   |
| Accessories .....                                | 6.75 - 6.76   |
| Function diagrams .....                          | 6.77 - 7.84   |
| Connection diagrams.....                         | 6.85 - 6.87   |
| Technical data & diagrams .....                  | 6.88 - 6.91   |
| Wiring notes.....                                | 6.92          |
| <b>CM-E Range</b>                                |               |
| Benefits and advantages.....                     | 6.94 - 6.95   |
| Monitoring features and application ranges ..... | 6.96 - 6.98   |
| <b>Current &amp; voltage monitoring relays</b>   |               |
| Benefits and advantages.....                     | 6.100         |
| Selection and conversion .....                   | 6.101 - 6.102 |

|                          |               |
|--------------------------|---------------|
| Ordering details.....    | 6.103 - 6.104 |
| Function diagrams .....  | 6.105 - 6.106 |
| Connection diagrams..... | 6.109         |
| Technical data.....      | 6.110 - 6.113 |

#### Three-phase monitoring relays

|   |               |
|---|---------------|
| Benefits, advantages & applications ..... | 6.116         |
| Selection and conversion .....            | 6.117 - 6.118 |
| Ordering details.....                     | 6.119 - 6.120 |
| Function diagrams .....                   | 6.121 - 6.125 |
| Connection diagrams, DIP switches .....   | 6.126 - 6.127 |
| Technical data.....                       | 6.128 - 6.137 |

#### Insulation monitoring relays

|   |               |
|---|---------------|
| Benefits and advantages.....                                | 6.140         |
| Insulation monitoring in IT systems.....                    | 6.141         |
| Application/monitoring function, measuring principles ..... | 6.142         |
| Characteristics .....                                       | 6.143         |
| Selection and conversion table.....                         | 6.144         |
| Ordering details.....                                       | 6.145         |
| Operating state indication .....                            | 6.146         |
| Connection diagrams, DIP switches.....                      | 6.147         |
| Technical data .....  | 6.148 - 6.151 |
| Application examples .....                                  | 6.152         |

#### Motor load monitoring relays

|                             |       |
|-----------------------------|-------|
| Fields of application ..... | 7.154 |
| Ordering details.....       | 6.155 |
| Technical data.....         | 6.157 |

#### Motor control and protection

|                              |               |
|------------------------------|---------------|
| Benefits and advantages..... | 6.160         |
| Technical data.....          | 6.161 - 6.162 |

#### Thermistor motor protection

|                              |               |
|------------------------------|---------------|
| Benefits and advantages..... | 6.164         |
| Product overview .....       | 6.165 - 6.166 |
| Ordering details.....        | 6.167 - 6.168 |
| Technical information.....   | 6.169 - 6.171 |

#### Temperature monitoring relays

|   |               |
|---|---------------|
| Benefits and advantages.....                              | 6.174         |
| Selection and conversion .....                            | 6.175         |
| Ordering details.....                                     | 6.176         |
| Overview, functional description and diagrams.....        | 6.177 - 6.178 |
| Connection diagrams, resistance thermometer sensors ..... | 6.179         |
| Technical data.....                                       | 6.180 - 6.182 |

#### Liquid level monitors & controls

|                              |               |
|------------------------------|---------------|
| Benefits and advantages..... | 6.164         |
| Ordering details.....        | 6.185 - 6.186 |
| Function diagrams .....      | 6.187 - 6.188 |
| Connection diagrams.....     | 6.189         |
| Application examples .....   | 6.190 - 6.191 |
| Technical data.....          | 6.192 - 6.194 |

#### Contact protection & sensor interface relays

|                            |               |
|----------------------------|---------------|
| Ordering details.....      | 6.196         |
| Technical information..... | 6.197 - 6.199 |

#### Cycle monitoring relay with watchdog function

|                       |       |
|-----------------------|-------|
| Ordering details..... | 6.202 |
| Technical data.....   | 6.203 |

#### General technical data

|                             |               |
|-----------------------------|---------------|
| Load limit curves .....     | 6.204         |
| Approximate dimensions..... | 6.205         |
| Accessories .....           | 6.206 - 6.207 |

*Continued next page*

## CR Range

## Interface relays

|                              |               |
|------------------------------|---------------|
| Benefits and advantages..... | 6.212         |
| Approvals and marks.....     | 6.213         |
| Ordering details.....        | 6.214 - 6.220 |
| Technical data.....          | 6.221 - 6.223 |
| Load limit curves.....       | 6.224         |
| Connection diagrams.....     | 6.225         |
| Approximate dimensions.....  | 6.226 - 6.227 |

## Interface relays, R600, R500

|                              |               |
|------------------------------|---------------|
| Benefits and advantages..... | 6.230         |
| Type designators.....        | 6.231         |
| Selection.....               | 6.232 - 6.233 |

## Interface relays, R600

|                              |               |
|------------------------------|---------------|
| Benefits and advantages..... | 6.234         |
| Ordering details.....        | 6.235 - 6.236 |
| Connection diagrams.....     | 6.237         |
| Technical information.....   | 6.238 - 6.242 |

## Interface relays, R500

|                            |       |
|----------------------------|-------|
| Selection.....             | 6.243 |
| Ordering details.....      | 6.244 |
| Technical information..... | 6.245 |

## Optocouplers

## Optocouplers, R600

|                          |               |
|--------------------------|---------------|
| Selection.....           | 6.248 - 6.249 |
| Ordering details.....    | 6.250         |
| Connection diagrams..... | 6.251         |
| Technical data.....      | 6.252 - 2.555 |

## Optocouplers, R500

|                          |               |
|--------------------------|---------------|
| Selection.....           | 6.256 - 6.257 |
| Connection diagrams..... | 6.258         |
| Technical data.....      | 6.259 - 6.264 |

## Accessories..... 6.266 - 6.273

## CL Range

## Logic relays

|                             |               |
|-----------------------------|---------------|
| System overview.....        | 6.276 - 6.277 |
| Approvals and marks.....    | 6.278         |
| Ordering details.....       | 6.279 - 6.282 |
| Technical data.....         | 6.283 - 6.296 |
| Approximate dimensions..... | 6.297 - 6.298 |

# Control relays



## Industrial control relays

Pilot duty rated for control circuits

Positively guided, AC & DC controlled



### NF / NFZ control relays

- 4 & 8 pole control relays
- Pilot duty rated up to 10 A
- For AC & DC control circuit switching
- Electronic AC/DC coil input voltages
- NFZ with low power consumption coils
- Direct PLC control  $\geq 24\text{VDC}$ , 500mA (NFZ)
- Mechanically linked contacts for safety
- Wide variety of accessories

### NS / NSL control relays

- 4 & 8 pole control relays
- For high-volume applications
- Pilot duty rated up to 10 A
- Bulk packaging available
- Screw & spring termination
- Mechanically linked contacts for safety
- AC or DC coil input voltages

### K / KC control & interface relays

- 4 pole miniature control relays
- Compact solutions up to 10 A
- Quick-connect & PCB mount options
- Interface relays for PLC control
- Mechanically linked contacts for safety
- AC or DC coil input voltages

| Standards & approvals | NF / NFZ | NS / NSL | K / KC  |
|-----------------------|----------|----------|---------|
|                       | E252354  | E252354  | E48139  |
|                       |          |          | LR56745 |
|                       | ✓        | ✓        | ✓       |
|                       | ✓        | ✓        | ✓       |

NOTE: K/C6 quick-connect and PCB-mount versions are UL recognized.

# General information



## Panorama



### Control relays

### Mini control relays – 4 pole





6

| IEC                    | AC-15 Rated operational current   | 400 V | A |
|------------------------|---|-------|---|
| UL/CSA                 | Pilot duty  |       |   |
|                        |   |       |   |
| AC Control supply      |  | Type  |   |
| DC Control supply      |  | Type  |   |
| AC / DC Control supply |  | Type  |   |

| 3   |   |   |
|---|---|---|
| A 600   |   |   |
|  |  |  |
| K6-22Z  | K6-31Z  | K6-40E  |
| KC6-22Z   | KC6-31Z   | KC6-0E  |
| –   | –   | –   |

See pages 6.12...6.14

| IEC                    | AC-15 Rated operational current   | 400 V | A |
|------------------------|---|-------|---|
| UL/CSA                 | Pilot duty  |       |   |
|                        |   |       |   |
| AC Control supply      |  | Type  |   |
| DC Control supply      |  | Type  |   |
| AC / DC Control supply |  | Type  |   |

|   |   |   |
|---|---|---|
| – | – | – |
| – | – | – |
| – | – | – |
| – | – | – |

# General information

## Panorama

### Control relays – 4 pole



| 3<br>A 600, Q 300     |                   |                   | 3<br>A 600, Q 600   |                 |                 |
|-----------------------|-------------------|-------------------|---------------------|-----------------|-----------------|
|                       |                   |                   |                     |                 |                 |
| NS22E<br>NS22ES       | NS31E<br>NS31ES   | NS40E<br>NS40ES   | NF22E<br>NFZ22E     | NF31E<br>NFZ31E | NF40E<br>NFZ40E |
| NSL22E<br>NSL22ES     | NSL31E<br>NSL31ES | NSL40E<br>NSL40ES | NF22E<br>NFZ22E     | NF31E<br>NFZ31E | NF40E<br>NFZ40E |
| —                     | —                 | —                 | NF22E<br>NFZ22E     | NF31E<br>NFZ31E | NF40E<br>NFZ40E |
| See pages 6.10...6.11 |                   |                   | See pages 6.8...6.9 |                 |                 |

6

### Control relays – 8 pole



| 3<br>A 600, Q 300     |                   |                   |                   |                   | 3<br>A 600, Q 600   |                 |                 |                 |                 |
|-----------------------|-------------------|-------------------|-------------------|-------------------|---------------------|-----------------|-----------------|-----------------|-----------------|
|                       |                   |                   |                   |                   |                     |                 |                 |                 |                 |
| NS44E<br>NS44ES       | NS53E<br>NS53ES   | NS62E<br>NS62ES   | NS71E<br>NS71ES   | NS80E<br>NS80ES   | NF44E<br>NFZ44E     | NF53E<br>NFZ53E | NF62E<br>NFZ62E | NF71E<br>NFZ71E | NF80E<br>NFZ80E |
| NSL44E<br>NSL44ES     | NSL53E<br>NSL53ES | NSL62E<br>NSL62ES | NSL71E<br>NSL71ES | NSL80E<br>NSL80ES | NF44E<br>NFZ44E     | NF53E<br>NFZ53E | NF62E<br>NFZ62E | NF71E<br>NFZ71E | NF80E<br>NFZ80E |
| —                     | —                 | —                 | —                 | —                 | NF44E<br>NFZ44E     | NF53E<br>NFZ53E | NF62E<br>NFZ62E | NF71E<br>NFZ71E | NF80E<br>NFZ80E |
| See pages 6.10...6.11 |                   |                   |                   |                   | See pages 6.8...6.9 |                 |                 |                 |                 |

# General information

## Technical terms and definitions

### Altitude

Refers to the height of the site where the equipment is located, expressed in meters above the sea level.

### Ambient temperature

Temperature of the air surrounding the unit.

### Circuits

#### • Auxiliary circuit

All the conducting parts of a contactor, intended to be included in a circuit different from the main circuit and the control circuit of the contactor e.g. signalization, interlocking circuits etc ...

#### • Control circuit

All the conducting parts of a contactor (other than the main circuit) included in a circuit used for the closing operation, or opening operation, or both, of the contactor.

#### • Main circuit

All the conducting parts of a contactor included in the circuit which it is designed to close or open.

### Coil operating range

Expressed as a multiple of the rated control circuit voltage  $U_c$  for the lower and upper limits.

### Cycle duration

Total time of the on-load + off-load period.

### Endurance / durability

#### • Electrical endurance

Number of on-load operating cycles (i.e. with current on the main contacts) a contactor can achieve, varies depending on the utilization category.

#### • Mechanical endurance

Number of off-load operating cycles (i.e. without current on the main contacts) a contactor can achieve.

### Inching

Energizing a motor once or repeatedly for short periods to obtain small movements of the driven mechanism.

### Insulation class according to the VDE 0110 and NFC 20-040

Characterizes contactors suitability in accordance with environment and utilization conditions. A contactor can be classified depending on its own clearance and creepage distances in the insulation classes A, B, C, D which correspond to different insulation voltage values.

The insulation class C is applicable to most of the industrial applications. Equipment described in this catalogue correspond to insulation class C.

### Intermittent duty

Duty in which the main contacts of a contactor remain closed for periods of time insufficient to allow the contactor to reach thermal equilibrium, the current-carrying periods being separated by off-load periods of sufficient duration to restore equality of temperature with the cooling medium.

### Mounting positions

Stated by the manufacturer. Please note restrictions when applicable.

### On-load factor

Ratio of the current flow time to the total time of the cycle x 100.

### Plugging

Stopping or reversing a motor quickly by interchanging two supply leads whilst the motor is running.

### Rated breaking capacity; Rated making capacity

Value of r.m.s current a contactor can break or make at a fixed voltage value, within the conditions specified by the standards, depending on the utilization category.

### Rated control circuit voltage $U_c$

Control voltage value for which the control circuit of the unit is sized.

### Rated insulation voltage $U_i$

Voltage value which designates the unit and to which dielectric tests, clearance and creepage distances are referred.

### Rated impulse withstand voltage $U_{imp}$

The highest peak value of an impulse voltage of prescribed form 1.2/50, which does not cause breakdown under specified conditions of test.

### Rated operating current $I_e$

Current value stated by the manufacturer and taking into account the rated operating voltage  $U_e$ , the rated frequency, the rated duty, the utilization category, the electrical contact life and the type of the protective enclosure.

### Rated operating voltage $U_e$

Voltage value to which utilization characteristics of the contactor are referred, i.e. phase to phase voltage in 3 phase circuits.

### Conventional thermal current $I_{th}$

Value of current the contactor can withstand with poles in closed position, in free air for an eight hour duty, without the temperature rise of its various parts exceeding the limits specified by the standards.

### Resistance to shocks

Requirements applicable for instance to vehicles, crane operation or switchgear slide-in module systems.

At the quoted permissible «g» values, contactors must not undergo a change in switching state and O/L relays must not trip.

### Resistance to vibrations

Requirements applicable to all the vehicles, vessels and other similar transport systems. At the quoted amplitude and vibration frequency values, the unit must be capable to achieve the required duty.

### Short-circuit protection coordination

Achieved by using back-up protection devices such as circuit-breakers, H.R.C. fuses or standard fuses.

Co-ordination types a, b, c are defined in IEC 292-1 publication, VDE 0660, NFC 63-650 standards. Co-ordination types "1" and "2" are defined in IEC 947-4-1.

#### • Type 1 co-ordination

There has been no discharge of parts beyond the enclosure. Damage to the contactor and the overload relay is acceptable.

#### • Type 2 co-ordination

No damage to the overload relay or other parts has occurred, except that welding of contactor or starter contacts is permitted, if they are easily separated.

### Switching frequency

Number of operating cycles per hour.

### Time

#### • Closing time

Time between energization of the coil until the moment the contacts of the first current path to be closed actually close.

#### • Opening time

Time from the beginning of state causing breaking until the moment when the contacts of the last current path to be opened are open.

#### • Minimal operation time

Shortest control duration to ensure complete closing or opening of a contactor.

#### • Short time current permissible

Value of current which the contactor can withstand in closed position for a short time period and within specified conditions.

#### • Time constant

Ratio of inductance to the resistance :  $L/R = \text{mH}/\text{Ohm} = \text{ms}$ .

# General information

## IEC Standards, utilization categories

### Standards

- IEC standards 158-1: "Contactors" and series IEC 292 :

"Motor-starters" have been revised and replaced by the new IEC 947-4-1 (1990-05): "Contactors and Motor-starters" referring to IEC 947-1 (1988): "General rules" The new standards will constitute the basis of the future European and National standards, not yet revised.

Therefore the ratings indicated in this catalog are established according to the former and the future standards.

- Main changes and additions in the new standards are:
- Revision and extension of the utilization categories (see hereafter)
- Replacement of the coordination classes types a, b, c by new types: "1" (approximately equivalent to former class "a") and "2" (approximately equivalent to former class "c") with additional requirements.
- Classification of the thermal overload relays in tripping classes: 10 A; 10; 20 and 30 depending on their tripping times, at 1.5 and 7.2 times their setting current, in order to cover motor applications depending on their starting times. Class 10 A is adapted for motors according to IEC 34-1.
- Introduction of tests to verify the connecting capability and the mechanical strength of terminals.

### Utilization categories

A contactor duty is characterized by the utilization category plus indication of the rated operating voltage and the rated operating current (see at Rated ...), or the motor characteristics.

### Utilization categories for contactors according to IEC 947-4-1

|                      |                |  |
|----------------------|----------------|--|
| Alternating current: | AC-1           | Non-inductive or slightly inductive loads, resistance furnaces. Power factor 0.7 - 0.8 (slightly inductive).   |
|                      | AC-2           | Slip-ring motors: starting, switching-off.   |
|                      | AC-3           | Squirrel-cage motors: starting, switching-off motors during running. Power factor 0.4 - 0.5 (AC-3).  |
|                      | AC-4           | Squirrel-cage motors: starting, plugging, inching.   |
|                      | AC-5a          | Switching of electric discharge lamp controls.   |
|                      | AC-5b          | Switching of incandescent lamps.   |
|                      | AC-6a          | Switching of transformers.   |
|                      | AC-6b          | Switching of capacitor banks   |
|                      | AC-8a<br>AC-8b | Hermetic refrigerant compressor motor control with manual resetting of overload releases<br>Hermetic refrigerant compressor motor control with automatic resetting of overload releases. |
| Direct current:      | DC-1           | Non-inductive or slightly inductive loads, resistance furnaces.  |
|                      | DC-3           | Shunt motors: starting, plugging, inching. Dynamic breaking of d.c. motors.  |
|                      | DC-5           | Series motors: starting, plugging, inching. Dynamic breaking of d.c. motors.   |
|                      | DC-6           | Switching of incandescent lamps  |

### Utilization categories for contactor relays according to IEC 947-5-1

|                      |       |   |
|----------------------|-------|---|
| Alternating current: | AC-12 | Control of resistive loads and solid state loads with isolation by opto couplers. |
|                      | AC-13 | Control of solid state loads with transformer isolation.                          |
|                      | AC-14 | Control of small electromagnetic loads ( $\leq 72$ VA).                           |
|                      | AC-15 | Control of electromagnetic loads ( $> 72$ VA).                                    |
| Direct current:      | DC-12 | Control of resistive loads and solid state loads with isolation by opto couplers. |
|                      | DC-13 | Control of electromagnets.  |
|                      | DC-14 | Control of electromagnetic loads having economy resistors in circuit.             |

Utilization categories AC-1, AC-2, AC-3, AC-4 and DC-1, DC-3, DC-5 are maintained with slightly more severe tests.

Other categories have been added in order to standardize specific applications. In fact some contactor applications and the specific criteria characterizing the types of load controlled can modify the recommended utilization characteristics. These major applications are, for example :

#### Switching of capacitor banks

This application is characterized by high current peaks when switching-on the contactor and presence of harmonic currents on uninterrupted duty. For this application, IEC 947-4-1 has defined an utilization category AC-6b. Practical ratings have to be defined according to tests or, in absence of tests, by a calculation indicated in IEC 947-4-1.

#### Switching of transformers

This application is characterized by high current peaks on contactor closing due to magnetization phenomena. The corresponding utilization category according to IEC 947-4-1 is AC-6a. Ratings are derived from test-values for AC-3 or AC-4 according to formula given in IEC 947-4-1.

#### Switching of lighting circuits

The current peaks on contactor closing and power factor vary depending on the type of lamps, the switching method used and if compensation systems are fitted or not.

IEC 947-4-1 contains two standard utilization categories

- AC-5a for switching of the electric discharge lamps.
- AC-5b for switching of incandescent lamp.

## General information

### Pilot duty ratings and overload trip classes

#### Pilot duty ratings for AC control circuit contacts

| Contact rating designation | Continuous thermal, test current (A) | Maximum current, 50/60 Hz (A) |       |          |       |          |       |          |       |              |       |
|----------------------------|--------------------------------------|-------------------------------|-------|----------|-------|----------|-------|----------|-------|--------------|-------|
|                            |                                      | 120 v ac                      |       | 240 v ac |       | 480 v ac |       | 600 v ac |       | Volt-amperes |       |
|                            |                                      | Make                          | Break | Make     | Break | Make     | Break | Make     | Break | Make         | Break |
| A150                       | 10                                   | 60                            | 6.00  | -        | -     | -        | -     | -        | -     | 7200         | 720   |
| A300                       | 10                                   | 60                            | 6.00  | 30       | 3.00  | -        | -     | -        | -     | 7200         | 720   |
| A600                       | 10                                   | 60                            | 6.00  | 30       | 3.00  | 15       | 1.50  | 12       | 1.20  | 7200         | 720   |
| B150                       | 5                                    | 30                            | 3.00  | -        | -     | -        | -     | -        | -     | 3600         | 360   |
| B300                       | 5                                    | 30                            | 3.00  | 15       | 1.50  | -        | -     | -        | -     | 3600         | 360   |
| B600                       | 5                                    | 30                            | 3.00  | 15       | 1.50  | 7.5      | 0.75  | 6        | 0.60  | 3600         | 360   |
| C150                       | 2.5                                  | 15                            | 1.5   | -        | -     | -        | -     | -        | -     | 1800         | 180   |
| C300                       | 2.5                                  | 15                            | 1.5   | 7.5      | 0.75  | -        | -     | -        | -     | 1800         | 180   |
| C600                       | 2.5                                  | 15                            | 1.5   | 7.5      | 0.75  | 3.75     | 0.375 | 3.00     | 0.30  | 1800         | 180   |
| D150                       | 1.0                                  | 3.60                          | 0.60  | -        | -     | -        | -     | -        | -     | 432          | 72    |
| D300                       | 1.0                                  | 3.60                          | 0.60  | 1.80     | 0.30  | -        | -     | -        | -     | 432          | 72    |
| E150                       | 0.5                                  | 1.80                          | 0.30  | -        | -     | -        | -     | -        | -     | 216          | 36    |

Mechanical switching ratings and test values as published in Table 1-4-1 of NEMA ICS 5-2000 (R2005, R2010)

#### Pilot duty ratings for DC control circuit contacts

| Contact rating designation | Continuous thermal, test current (A) | Maximum current, 50/60 Hz (A) |  |              |  |                 |  |              |  |
|----------------------------|--------------------------------------|-------------------------------|--|--------------|--|-----------------|--|--------------|--|
|                            |                                      | 120 v dc                      |  | 250 v dc     |  | 301 to 600 v dc |  | Volt-amperes |  |
|                            |                                      | Make / Break                  |  | Make / Break |  | Make / Break    |  | Make / Break |  |
| N150                       | 10                                   | 2.2                           |  | -            |  | -               |  | 275          |  |
| N300                       | 10                                   | 2.2                           |  | 1.1          |  | -               |  | 275          |  |
| N600                       | 10                                   | 2.2                           |  | 1.1          |  | 0.40            |  | 275          |  |
| P150                       | 5.0                                  | 1.1                           |  | -            |  | -               |  | 138          |  |
| P300                       | 5.0                                  | 1.1                           |  | 0.55         |  | -               |  | 138          |  |
| P600                       | 5.0                                  | 1.1                           |  | 0.55         |  | 0.20            |  | 138          |  |
| Q150                       | 2.5                                  | 0.55                          |  | -            |  | -               |  | 69           |  |
| Q300                       | 2.5                                  | 0.55                          |  | 0.27         |  | -               |  | 69           |  |
| Q600                       | 2.5                                  | 0.55                          |  | 0.27         |  | 0.10            |  | 69           |  |
| R150                       | 1.0                                  | 0.22                          |  | -            |  | -               |  | 28           |  |
| R300                       | 1.0                                  | 0.22                          |  | 0.11         |  | -               |  | 28           |  |

Mechanical switching ratings and test values as published in Table 1-4-1 of NEMA ICS 5-2000 (R2005, R2010)

### Pilot duty rating explanation

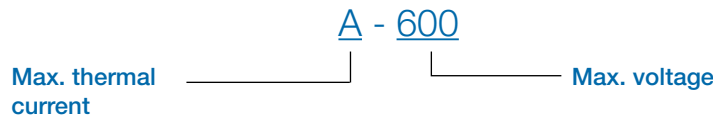



## General information

### NF/NFZ control relays

#### 4 & 8 pole

#### Description

NF / NFZ control relays are provided in either four or eight auxiliary pole configurations with a variety of accessories including additional auxiliary contacts and electronic timers.

#### Application

NF / NFZ control relays are pilot duty rated and primarily used for switching both AC and DC control circuits.

#### Control circuit types

NF / NFZ coils are designed to utilize both AC (50/60 Hz) and DC control circuit inputs ranging from 12...500V. Surge suppression is included. NFZ types offer low power consumption coils.

#### Control relay types

4-pole:

NF(Z)22E, NF(Z)31E, NF(Z)40E

8-pole:

NF(Z)44E, NF(Z)53E, NF(Z)62E  
NF(Z)71E, NF(Z)80E

Quick DIN-rail mount & dismount, no tools required

- 35 x 7.5mm &
- 35 x 15mm

Integral surge suppression

Actuator for side-mount accessories

Contoured sides for easy access to panel mounting holes

Terminals on NF / NFZ control relays are delivered in open position with captive screws (screws of unused terminals must be tightened)

IP20 degree protection according to IEC/EN 60947-1; protection from live parts according to VDE0106 Part. 100.

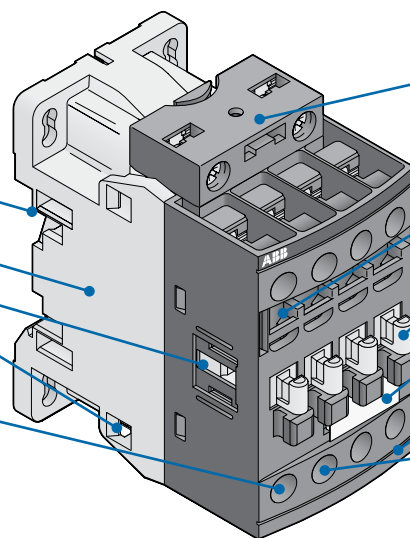

Detachable coil terminals

- Can be pre-wired prior to installation
- Can easily be rotated from top (standard) to bottom

Front-mount coil termination available (4-pole only)

Stops for attaching front-mount accessories (4-pole only)

Function markers included as standard on NF / NFZ control relays

Clear indication of coil voltages and frequencies

Terminal screws:

- Posidrive (+,-) No 2

## Catalog number explanation

For reference only – not all combinations will produce valid catalog numbers

NF 31 E - 13

Control relay type

Control relay type

- 22 = 2 NO / 2 NC
- 31 = 3 NO / 1 NC
- 40 = 4 NO
- 44 = 4 NO / 4 NC
- 53 = 5 NO / 3 NC
- 62 = 6 NO / 2 NC
- 71 = 7 NO / 1 NC
- 80 = 8 NO

Coil voltage code

(see product selection pages)

# NF, 4 & 8 pole

For pilot duty applications up to 10 A  
Electronic AC/DC operated coils

## Description

- **NF** control relays include an electronic coil interface accepting a wide control voltage  $U_c$  min. ...  $U_c$  max.  
Only four coils cover control voltages between 24...500 V 50/60 Hz or 20...500 V DC
- **NF** control relays can manage large control voltage variations. One coil (i.e. 100...250 V 50/60 Hz - DC) can be used for different control voltages used worldwide without any coil change
- **NF** control relays have built-in surge protection and do not require additional surge suppressors
- The control relays have mechanically-linked auxiliary contacts compliant with Annex L of IEC 60947-5-1 and include the "Mechanically Linked" symbol on their side
- 8-pole control relays are mounted with a non-removable auxiliary contact block (2<sup>nd</sup> stack).

## Ordering Details

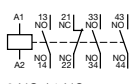
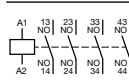
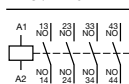
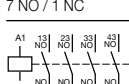
| Number of contacts   | Control voltage           |                       | Catalog number |
|--|---------------------------|-----------------------|----------------|
|  | 1 <sup>st</sup> stack     | 2 <sup>nd</sup> stack |                |
|  | Range                     |                       |                |
|  | $U_c$ min. ... $U_c$ max. |                       |                |
|  | V 50/60 Hz                | V DC                  |                |
| <br>2 NO / 2 NC   | 24..60                    | 20..60                | NF22E-11       |
|  | 48...130                  | 48...130              | NF22E-12       |
|  | 100...250                 | 100...250             | NF22E-13       |
|  | 250...500                 | 250...500             | NF22E-14       |
| <br>3 NO / 1 NC   | 24..60                    | 20..60                | NF31E-11       |
|  | 48...130                  | 48...130              | NF31E-12       |
|  | 100...250                 | 100...250             | NF31E-13       |
|  | 250...500                 | 250...500             | NF31E-14       |
| <br>4 NO         | 24..60                    | 20..60                | NF40E-11       |
|  | 48...130                  | 48...130              | NF40E-12       |
|  | 100...250                 | 100...250             | NF40E-13       |
|  | 250...500                 | 250...500             | NF40E-14       |
| <br>4 NO / 4 NC | 24..60                    | 20..60                | NF44E-11       |
|  | 48...130                  | 48...130              | NF44E-12       |
|  | 100...250                 | 100...250             | NF44E-13       |
|  | 250...500                 | 250...500             | NF44E-14       |
| <br>5 NO / 3 NC | 24..60                    | 20..60                | NF53E-11       |
|  | 48...130                  | 48...130              | NF53E-12       |
|  | 100...250                 | 100...250             | NF53E-13       |
|  | 250...500                 | 250...500             | NF53E-14       |
| <br>6 NO / 2 NC | 24..60                    | 20..60                | NF62E-11       |
|  | 48...130                  | 48...130              | NF62E-12       |
|  | 100...250                 | 100...250             | NF62E-13       |
|  | 250...500                 | 250...500             | NF62E-14       |
| <br>7 NO / 1 NC | 24..60                    | 20..60                | NF71E-11       |
|  | 48...130                  | 48...130              | NF71E-12       |
|  | 100...250                 | 100...250             | NF71E-13       |
|  | 250...500                 | 250...500             | NF71E-14       |
| <br>8 NO        | 24..60                    | 20..60                | NF80E-11       |
|  | 48...130                  | 48...130              | NF80E-12       |
|  | 100...250                 | 100...250             | NF80E-13       |
|  | 250...500                 | 250...500             | NF80E-14       |

## Main dimensions mm, inches

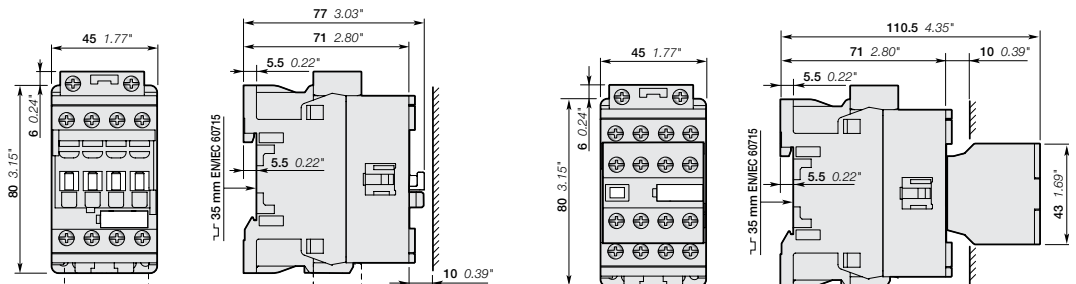

NF...22E, NF...31E, NF...40E

NF...44E, NF...53E, NF...62E, NF...71E, NF...80E

# NFZ, 4 & 8 pole

## For pilot duty applications up to 10 A

### Low power consumption, electronic AC/DC operated coils

#### Description

- NFZ control relays include an electronic coil interface accepting a wide control voltage  $U_c$  min. ...  $U_c$  max. and managing large control voltage variations.
- NFZ control relays cover control voltages between 24...250 V 50/60 Hz or 12...250 V DC
- NFZ control relays allow direct control by PLC-output  $\geq 24$  V DC 500 mA and obtain a reduced holding coil consumption.
- NFZ control relays withstand short dips and voltage interruptions (SEMI F47-0706 compliance)
- NFZ control relays have built-in surge protection and do not require additional surge suppressors
- The control relays have mechanically-linked auxiliary contacts compliant with Annex L of IEC 60947-5-1 and include the "Mechanically Linked" symbol on their side
- 8-pole control relays are mounted with a non-removable auxiliary contact block (2<sup>nd</sup> stack).



NFZ22E



NFZ44E

#### Ordering Details

| Number of contacts<br>1 <sup>st</sup> stack      2 <sup>nd</sup> stack | Control voltage<br>Range  |           | Catalog number |
|--|---------------------------|-----------|----------------|
|  | $U_c$ min. ... $U_c$ max. |           |                |
|  | V 50/60 Hz                | V DC      |                |
| <br>2 NO / 2 NC  | -                         | 12...20   | NFZ22E-20      |
|  | 24...60                   | 20...60   | NFZ22E-21      |
|  | 48...130                  | 48...130  | NFZ22E-22      |
|  | 100...250                 | 100...250 | NFZ22E-23      |
| <br>3 NO / 1 NC  | -                         | 12...20   | NFZ31E-20      |
|  | 24...60                   | 20...60   | NFZ31E-21      |
|  | 48...130                  | 48...130  | NFZ31E-22      |
|  | 100...250                 | 100...250 | NFZ31E-23      |
| <br>4 NO   | -                         | 12...20   | NFZ40E-20      |
|  | 24...60                   | 20...60   | NFZ40E-21      |
|  | 48...130                  | 48...130  | NFZ40E-22      |
|  | 100...250                 | 100...250 | NFZ40E-23      |
| <br>4 NO / 4 NC  | -                         | 12...20   | NFZ44E-20      |
|  | 24...60                   | 20...60   | NFZ44E-21      |
|  | 48...130                  | 48...130  | NFZ44E-22      |
|  | 100...250                 | 100...250 | NFZ44E-23      |
| <br>5 NO / 3 NC  | -                         | 12...20   | NFZ53E-20      |
|  | 24...60                   | 20...60   | NFZ53E-21      |
|  | 48...130                  | 48...130  | NFZ53E-22      |
|  | 100...250                 | 100...250 | NFZ53E-23      |
| <br>6 NO / 2 NC  | -                         | 12...20   | NFZ62E-20      |
|  | 24...60                   | 20...60   | NFZ62E-21      |
|  | 48...130                  | 48...130  | NFZ62E-22      |
|  | 100...250                 | 100...250 | NFZ62E-23      |
| <br>7 NO / 1 NC  | -                         | 12...20   | NFZ71E-20      |
|  | 24...60                   | 20...60   | NFZ71E-21      |
|  | 48...130                  | 48...130  | NFZ71E-22      |
|  | 100...250                 | 100...250 | NFZ71E-23      |
| <br>8 NO   | -                         | 12...20   | NFZ80E-20      |
|  | 24...60                   | 20...60   | NFZ80E-21      |
|  | 48...130                  | 48...130  | NFZ80E-22      |
|  | 100...250                 | 100...250 | NFZ80E-23      |

#### Main dimensions mm, inches

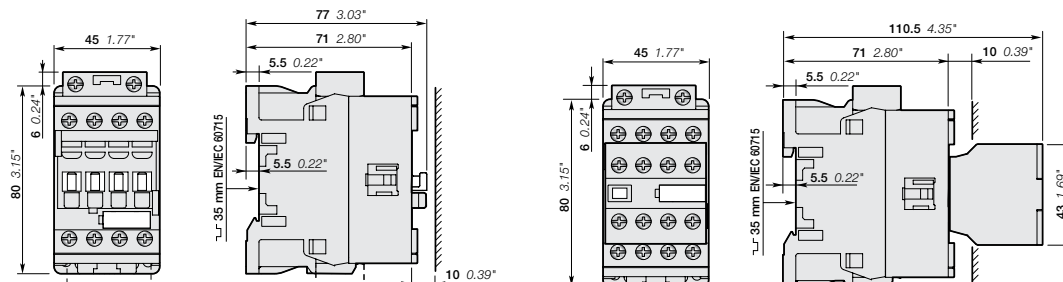

## NS/NSL 4 & 8 pole

For pilot duty applications up to 10 A

AC or DC operated coils, bulk packaged for high volume

### Description

NS/NSL contactor relays are used for switching auxiliary and control circuits.

These contactor relays are designed with:

- 4 poles or 8 poles. Contactor relays have mechanically linked auxiliary contact elements (side-marked symbol)
- Suitable for direct PLC control (DC 3W)
- add-on auxiliary contact blocks for front mounting and a comprehensive range of accessories.

### Ordering details

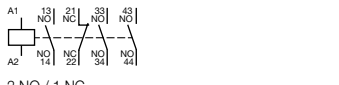
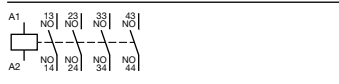
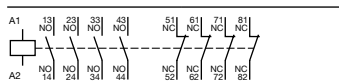
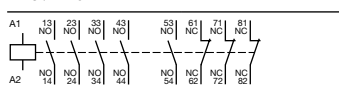
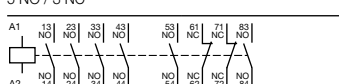
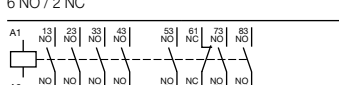
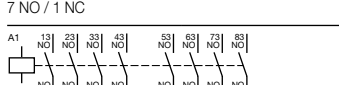
| Number of contacts   | Rated control circuit voltage $U_c$ | Catalog number, AC controlled | Rated control circuit voltage $U_c$ | Catalog number, DC controlled |
|--|-------------------------------------|-------------------------------|-------------------------------------|-------------------------------|
|  |                                     |                               |                                     |                               |
| <br>2 NO / 2 NC   | V 50 Hz                             | 24                            | 24                                  | NSL22E-81M                    |
|  | V 60 Hz                             | -                             | 120                                 | NSL22E-83M                    |
| <br>3 NO / 1 NC   | V 50 Hz                             | 24                            | 24                                  | NSL31E-81M                    |
|  | V 60 Hz                             | -                             | 120                                 | NSL31E-83M                    |
| <br>4 NO          | V 50 Hz                             | 24                            | 24                                  | NSL40E-81M                    |
|  | V 60 Hz                             | -                             | 120                                 | NSL40E-83M                    |
| <br>4 NO / 4 NC  | V 50 Hz                             | 24                            | 24                                  | NSL44E-81M                    |
|  | V 60 Hz                             | -                             | 120                                 | NSL44E-83M                    |
| <br>5 NO / 3 NC | V 50 Hz                             | 24                            | 24                                  | NSL53E-81M                    |
|  | V 60 Hz                             | -                             | 120                                 | NSL53E-83M                    |
| <br>6 NO / 2 NC | V 50 Hz                             | 24                            | 24                                  | NSL62E-81M                    |
|  | V 60 Hz                             | -                             | 120                                 | NSL62E-83M                    |
| <br>7 NO / 1 NC | V 50 Hz                             | 24                            | 24                                  | NSL71E-81M                    |
|  | V 60 Hz                             | -                             | 120                                 | NSL71E-83M                    |
| <br>8 NO        | V 50 Hz                             | 24                            | 24                                  | NSL80E-81M                    |
|  | V 60 Hz                             | -                             | 120                                 | NSL80E-83M                    |

NOTE: For DC operated devices, the polarity of A1+ and A2- must be respected.

### Main dimensions mm, inches

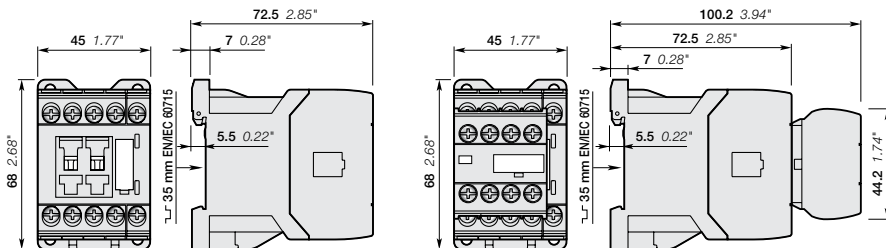

NS22E, NS31E, NS40E

NS44E, NS53E, NS62E, NS71E, NS80E



4 pole



8 pole

### Standard bulk pack quantities (M)

| Control relays                                      | Quantity |
|---|----------|
| NS/L22E<br>NS/L31E<br>NS/L40E                       | 40       |
| NS/L44E<br>NS/L53E<br>NS/L62E<br>NS/L71E<br>NS/L80E | 20       |

### Additional coil voltage codes

| AC voltages |           | Coil code |
|-------------|-----------|-----------|
| V - 50 Hz   | V - 60 Hz |           |
| 42          | 42        | 21        |
| 48          | 48        | 22        |
| 110         | 110       | 23        |
| 115         | 115       | 24        |
| 220         | 220       | 25        |
| 240         | 240       | 27        |
| -           | 277       | 17        |
| 380         | -         | 13        |
| 415         | 415       | 29        |

| DC voltages |  | Coil code |
|-------------|--|-----------|
| V - DC      |  |           |
| 12          |  | 80        |
| 60          |  | 84        |
| 125         |  | 87        |
| 240         |  | 89        |

# NS/NSL 4 & 8 pole, spring terminated

For pilot duty applications up to 10 A  
AC or DC operated coils, bulk packaged for high volume

## Description

NS/NSL contactor relays are used for switching auxiliary and control circuits.

These contactor relays are designed with:

- 4 poles or 8 poles. Contactor relays have mechanically linked auxiliary contact elements (side-marked symbol)
- Suitable for direct PLC control (DC 3W)
- add-on auxiliary contact blocks for front mounting and a comprehensive range of accessories.

## Ordering details

| Number of contacts<br>1st stack      2nd stack | Rated control circuit voltage<br>$U_c$ |         | Catalog number,<br>AC controlled | Rated control circuit voltage<br>$U_c$ | Catalog number,<br>DC controlled |
|--|--|---------|----------------------------------|--|----------------------------------|
|  | V 50 Hz                                | V 60 Hz |                                  | V-DC                                   |                                  |
| <br>2 NO / 2 NC                                | 24                                     | 24      | NS22ES-20M                       | 24                                     | NSL22ES-81M                      |
|  | -                                      | 120     | NS22ES-16M                       | 48                                     | NSL22ES-83M                      |
|  | 230                                    | 230     | NS22ES-26M                       | 110                                    | NSL22ES-86M                      |
| <br>3 NO / 1 NC                                | 24                                     | 24      | NS31ES-20M                       | 24                                     | NSL31ES-81M                      |
|  | -                                      | 120     | NS31ES-16M                       | 48                                     | NSL31ES-83M                      |
|  | 230                                    | 230     | NS31ES-26M                       | 110                                    | NSL31ES-86M                      |
| <br>4 NO                                       | 24                                     | 24      | NS40ES-20M                       | 24                                     | NSL40ES-81M                      |
|  | -                                      | 120     | NS40ES-16M                       | 48                                     | NSL40ES-83M                      |
|  | 230                                    | 230     | NS40ES-26M                       | 110                                    | NSL40ES-86M                      |
| <br>4 NO / 4 NC                                | 24                                     | 24      | NS44ES-20M                       | 24                                     | NSL44ES-81M                      |
|  | -                                      | 120     | NS44ES-16M                       | 48                                     | NSL44ES-83M                      |
|  | 230                                    | 230     | NS44ES-26M                       | 110                                    | NSL44ES-86M                      |
| <br>4 NO / 3 NC                                | 24                                     | 24      | NS53ES-20M                       | 24                                     | NSL53ES-81M                      |
|  | -                                      | 120     | NS53ES-16M                       | 48                                     | NSL53ES-83M                      |
|  | 230                                    | 230     | NS53ES-26M                       | 110                                    | NSL53ES-86M                      |
| <br>6 NO / 2 NC                                | 24                                     | 24      | NS62ES-20M                       | 24                                     | NSL62ES-81M                      |
|  | -                                      | 120     | NS62ES-16M                       | 48                                     | NSL62ES-83M                      |
|  | 230                                    | 230     | NS62ES-26M                       | 110                                    | NSL62ES-86M                      |
| <br>7 NO / 1 NC                                | 24                                     | 24      | NS71ES-20M                       | 24                                     | NSL71ES-81M                      |
|  | -                                      | 120     | NS71ES-16M                       | 48                                     | NSL71ES-83M                      |
|  | 230                                    | 230     | NS71ES-26M                       | 110                                    | NSL71ES-86M                      |
| <br>8 NO                                       | 24                                     | 24      | NS80ES-20M                       | 24                                     | NSL80ES-81M                      |
|  | -                                      | 120     | NS80ES-16M                       | 48                                     | NSL80ES-83M                      |
|  | 230                                    | 230     | NS80ES-26M                       | 110                                    | NSL80ES-86M                      |
|  |  | 400     | NS80ES-28M                       | 220                                    | NSL80ES-88M                      |

## Standard bulk pack quantities (M)

| Control relays   | Quantity |
|--|----------|
| NS/L22ES<br>NS/L31ES<br>NS/L40ES                         | 40       |
| NS/L44ES<br>NS/L53ES<br>NS/L62ES<br>NS/L71ES<br>NS/L80ES | 20       |

## Additional coil voltage codes

| AC voltages |           | Coil code |
|-------------|-----------|-----------|
| V - 50 Hz   | V - 60 Hz |           |
| 42          | 42        | 21        |
| 48          | 48        | 22        |
| 110         | 110       | 23        |
| 115         | 115       | 24        |
| 220         | 220       | 25        |
| 240         | 240       | 27        |
| -           | 277       | 17        |
| 380         | -         | 13        |
| 415         | 415       | 29        |

| DC voltages | Coil code |
|-------------|-----------|
| V - DC      |           |
| 12          | 80        |
| 60          | 84        |
| 125         | 87        |
| 240         | 89        |

## Main dimensions mm, inches

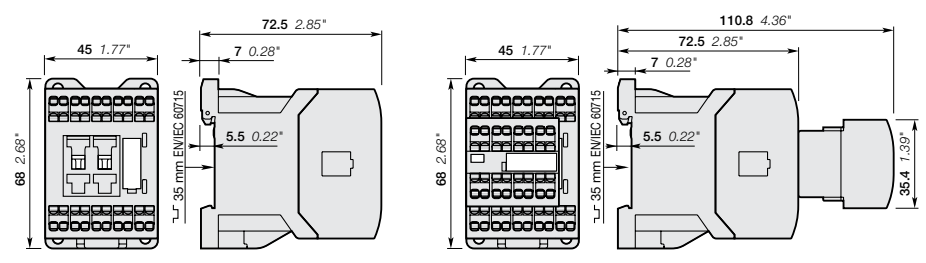

NSL22E, NSL31E, NSL40E

NSL44E, NSL53E, NSL62E, NSL71E, NSL80E

## K6 miniature, 4 pole

For compact pilot duty applications up to 10 A  
AC operated coils

### Description

These contactors are designed with:

- 4 poles with various contact combinations
- control circuit: AC operated, low coil consumption (3.5 VA at pull-in and at holding)
- hum-free coil
- add-on auxiliary contact blocks for front or side mounting
- designed for rail or wall mounting



K6



K6...F



K6...P

### Ordering details

| Number of contacts | Rated control circuit voltage $U_c$ |           | Catalog number, screw termination | Catalog number, quick-connect termination | Catalog number, PCB-mount termination |
|--------------------|-------------------------------------|-----------|-----------------------------------|---|---------------------------------------|
|                    | V-50 Hz                             | V-60 Hz   |                                   |   |                                       |
| <p>2 NO / 2 NC</p> | 24                                  | 24        | K6-22Z-01                         | K6-22Z-F01                                | K6-22Z-P01                            |
|                    | 42                                  | 42        | K6-22Z-02                         | K6-22Z-F02                                | K6-22Z-P02                            |
|                    | 48                                  | 48        | K6-22Z-03                         | K6-22Z-F03                                | K6-22Z-P03                            |
|                    | 110...127                           | 110...127 | K6-22Z-84                         | K6-22Z-F84                                | K6-22Z-P84                            |
|                    | 220...240                           | 220...240 | K6-22Z-80                         | K6-22Z-F80                                | K6-22Z-P80                            |
| <p>3 NO / 1 NC</p> | 24                                  | 24        | K6-31Z-01                         | K6-31Z-F01                                | K6-31Z-P01                            |
|                    | 42                                  | 42        | K6-31Z-02                         | K6-31Z-F02                                | K6-31Z-P02                            |
|                    | 48                                  | 48        | K6-31Z-03                         | K6-31Z-F03                                | K6-31Z-P03                            |
|                    | 110...127                           | 110...127 | K6-31Z-84                         | K6-31Z-F84                                | K6-31Z-P84                            |
|                    | 220...240                           | 220...240 | K6-31Z-80                         | K6-31Z-F80                                | K6-31Z-P80                            |
| <p>4 NO</p>        | 24                                  | 24        | K6-40E-01                         | K6-40E-F01                                | K6-40E-P01                            |
|                    | 42                                  | 42        | K6-40E-02                         | K6-40E-F02                                | K6-40E-P02                            |
|                    | 48                                  | 48        | K6-40E-03                         | K6-40E-F03                                | K6-40E-P03                            |
|                    | 110...127                           | 110...127 | K6-40E-84                         | K6-40E-F84                                | K6-40E-P84                            |
|                    | 220...240                           | 220...240 | K6-40E-80                         | K6-40E-F80                                | K6-40E-P80                            |
|                    | 380...415                           | 380...415 | K6-40E-85                         | K6-40E-F85                                | K6-40E-P85                            |

### Main dimensions mm, inches

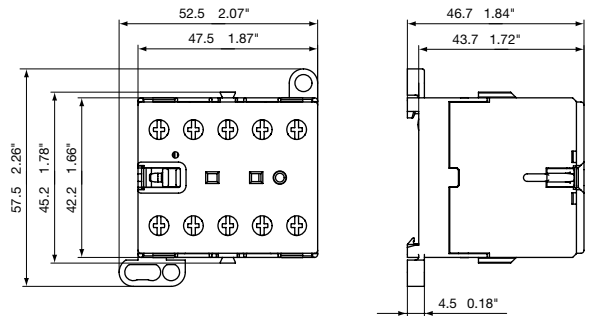

K6, K6...F

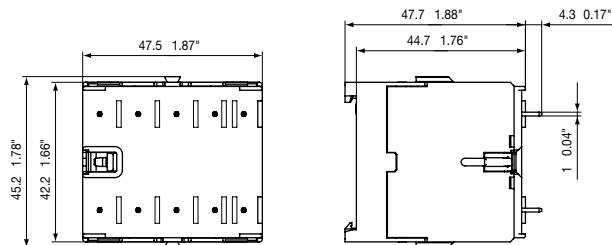

K6...P

# KC6 miniature, 4 pole

## For compact pilot duty applications up to 10 A DC operated coils



KC6



KC6...F

### Description

These contactors are designed with:

- 4 poles with various contact combinations
- control circuit: DC operated, low coil consumption (3.5 W at pull-in and at holding)
- hum-free coil
- add-on auxiliary contact blocks for front or side mounting
- designed for rail or wall mounting

### Ordering details

| Number of contacts | Rated control circuit voltage $U_c$ | Catalog number, screw termination | Catalog number, quick-connect termination | Catalog number, PCB-mount termination |
|--------------------|-------------------------------------|-----------------------------------|---|---------------------------------------|
|                    | V-DC                                |                                   |   |                                       |
| <p>2 NO / 2 NC</p> | 12                                  | KC6-22Z-07                        | KC6-22Z-F07                               | KC6-22Z-P07                           |
|                    | 24                                  | KC6-22Z-01                        | KC6-22Z-F01                               | KC6-22Z-P01                           |
|                    | 48                                  | KC6-22Z-16                        | KC6-22Z-F16                               | KC6-22Z-P16                           |
|                    | 60                                  | KC6-22Z-13                        | KC6-22Z-F13                               | KC6-22Z-P13                           |
|                    | 110...125                           | KC6-22Z-04                        | KC6-22Z-F04                               | KC6-22Z-P04                           |
|                    | 220...240                           | KC6-22Z-05                        | KC6-22Z-F05                               | KC6-22Z-P05                           |
| <p>3 NO / 1 NC</p> | 12                                  | KC6-31Z-07                        | KC6-31Z-F07                               | KC6-31Z-P07                           |
|                    | 24                                  | KC6-31Z-01                        | KC6-31Z-F01                               | KC6-31Z-P01                           |
|                    | 48                                  | KC6-31Z-16                        | KC6-31Z-F16                               | KC6-31Z-P16                           |
|                    | 60                                  | KC6-31Z-13                        | KC6-31Z-F13                               | KC6-31Z-P13                           |
|                    | 110...125                           | KC6-31Z-04                        | KC6-31Z-F04                               | KC6-31Z-P04                           |
|                    | 220...240                           | KC6-31Z-05                        | KC6-31Z-F05                               | KC6-31Z-P05                           |
| <p>4 NO</p>        | 12                                  | KC6-40E-07                        | KC6-40E-F07                               | KC6-40E-P07                           |
|                    | 24                                  | KC6-40E-01                        | KC6-40E-F01                               | KC6-40E-P01                           |
|                    | 48                                  | KC6-40E-16                        | KC6-40E-F16                               | KC6-40E-P16                           |
|                    | 60                                  | KC6-40E-13                        | KC6-40E-F13                               | KC6-40E-P13                           |
|                    | 110...125                           | KC6-40E-04                        | KC6-40E-F04                               | KC6-40E-P04                           |
|                    | 220...240                           | KC6-40E-05                        | KC6-40E-F05                               | KC6-40E-P05                           |

### Main dimensions mm, inches

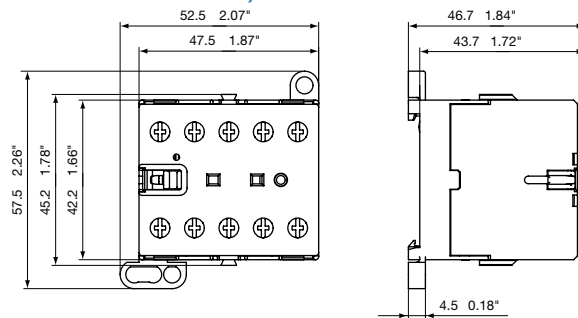

KC6, KC6...F

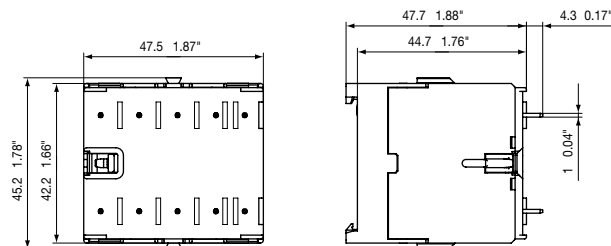

KC6...P

# KC6 interface relays, 4 pole

For interface applications up to 4 A  
Low power consumption, DC operated coils

## Description

KC6 4-pole interface mini contactor relays are space optimized control products mainly used for control functions or for small loads up to 4 A.



These contactors are designed with:

- 4 poles with various contact combinations
- control circuit: DC operated, low coil consumption (1.4 ... 2.8 W at pull-in and at holding)
- hum-free coil
- no auxiliary contact block permitted for mounting
- designed for rail or wall mounting



KC6

## Ordering details

| Rated control circuit voltage U <sub>c</sub> | Auxiliary contacts fitted   |   | Catalog number, screw termination | Catalog number, quick-connect termination | Catalog number, PCB-mount termination |
|--|---|---|-----------------------------------|---|---------------------------------------|
|  |  |  |                                   |   |                                       |
| VDC  |   |   |                                   |   |                                       |
| DC operation 24 V / 1.4 W                    |   |   |                                   |   |                                       |
| 24   | 3   | 1   | KC6-31Z-1.4                       | KC6-31Z-F1.4                              | KC6-31Z-P1.4                          |
| 24   | 4   | 0   | KC6-40E-1.4                       | KC6-40E-F1.4                              | KC6-40E-P1.4                          |
| DC operation 17...32 V / 2.4 W               |   |   |                                   |   |                                       |
| 17...32 (1)                                  | 3   | 1   | KC6-31Z-2.4                       | KC6-31Z-F2.4                              | KC6-31Z-P2.4                          |
| 17...32 (1)                                  | 4   | 0   | KC6-40E-2.4                       | KC6-40E-F2.4                              | KC6-40E-P2.4                          |
| DC operation 24 V / 1.7 W                    |   |   |                                   |   |                                       |
| 24   | 2   | 2   | K6S-22Z-1.7                       | K6S-22Z-F1.7                              | K6S-22Z-P1.7                          |
| 24   | 3   | 1   | K6S-31Z-1.7                       | K6S-31Z-F1.7                              | K6S-31Z-P1.7                          |
| 24   | 4   | 0   | K6S-40E-1.7                       | K6S-40E-F1.7                              | K6S-40E-P1.7                          |
| DC operation 17...32 V / 2.8 W               |   |   |                                   |   |                                       |
| 17...32 (1)                                  | 2   | 2   | K6S-22Z-2.8                       | K6S-22Z-F2.8                              | K6S-22Z-P2.8                          |
| 17...32 (1)                                  | 3   | 1   | K6S-31Z-2.8                       | K6S-31Z-F2.8                              | K6S-31Z-P2.8                          |
| 17...32 (1)                                  | 4   | 0   | K6S-40E-2.8                       | K6S-40E-F2.8                              | K6S-40E-P2.8                          |

(1) U<sub>c</sub> min. and U<sub>c</sub> max. limit values, including the voltage variation tolerances (-15 % and +10 %).



KC6...F



KC6...P

## Main dimensions mm, inches

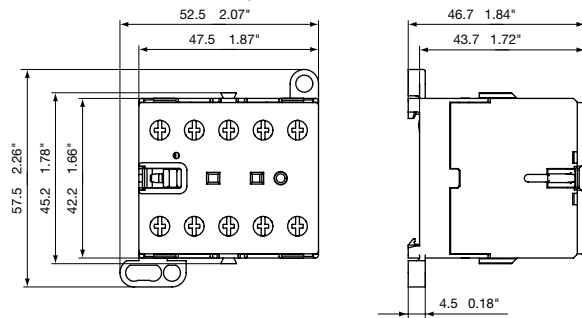

KC6, KC6...F

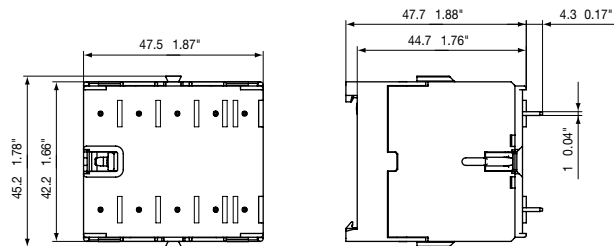

K6...P



## NF(Z), 4 & 8 pole Accessory fitting details

### Contactor relays and main accessories (other accessories available)

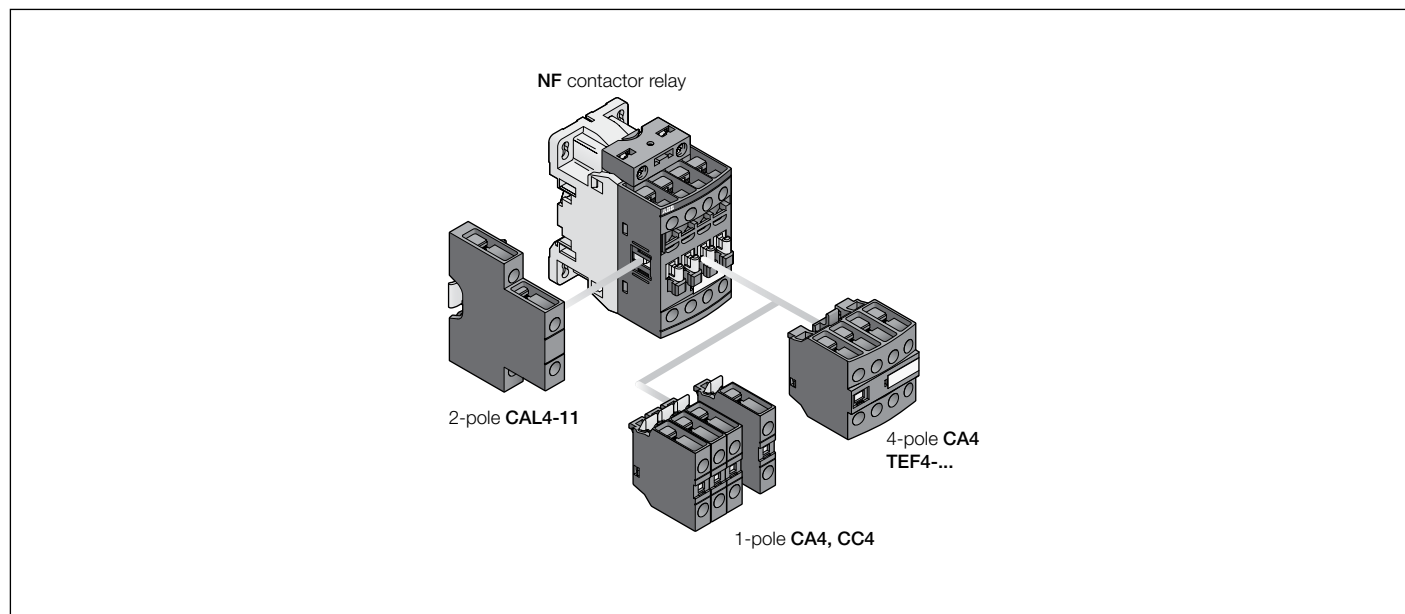

6

### Accessory fitting details for a NF control relay

Many configurations of accessories are possible depending on whether these are front-mounted or side-mounted.

| Control relay types | Main poles | Front-mounted accessories   |            |          | Side-mounted accessories    |            |
|---------------------|------------|---|------------|----------|-----------------------------|------------|
|                     |            | Auxiliary contact blocks  |            | Timers   | Auxiliary contact blocks    |            |
|                     |            | 1-pole CA4 / 1-pole CC4   | 4-pole CA4 | TEF4-... | Left side<br>2-pole CAL4-11 | Right side |
|                     |            | Max. add-on N.C. auxiliary contacts: 3 N.C. max. on positions 1, 2, 3, 4 and 2 N.C. max. on positions 1 ±30°, 5 |            |          |                             |            |
| NF..                | 2 2 E      | 4 max.  | or 1       | or 1     | + 1                         | -          |
| NF..                | 3 1 E      | 2 max.  | -          | -        | + 1                         | + 1        |
|                     |            | Max. add-on N.C. auxiliary contacts: 4 N.C. max. on positions 1, 2, 3, 4 and 3 N.C. max. on positions 1 ±30°, 5 |            |          |                             |            |
| NF..                | 4 0 E      | 4 max.  | or 1       | or 1     | + 1                         | -          |
|                     |            | 2 max.  | -          | -        | + 1                         | + 1        |
| NF..                | 4 4 E      |   |            |          |                             |            |
| NF..                | 5 3 E      |   |            |          |                             |            |
| NF..                | 6 2 E      | -   | -          | -        | 1                           | -          |
| NF..                | 7 1 E      |   |            |          |                             |            |
| NF..                | 8 0 E      |   |            |          |                             |            |

# NS/L 4 & 8 pole, screw terminated Accessory fitting details

## Contactor relays and main accessories (other accessories available)

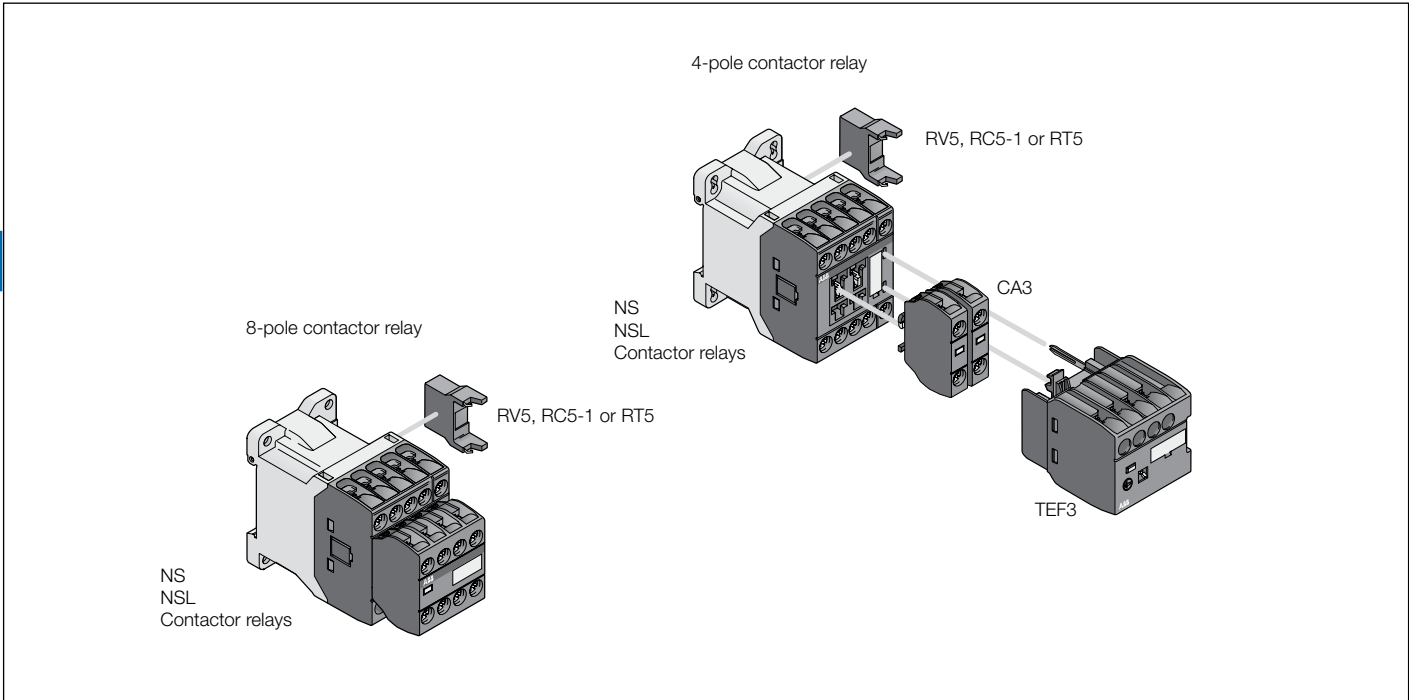

## Main accessory fitting details

| Contactor types | Main poles<br> | Front-mounted accessories |                  |   | Side-mounted accessories |          |
|-----------------|----------------|---------------------------|------------------|---|--------------------------|----------|
|                 |                | Auxiliary contact blocks  | Electronic timer |   | Surge suppressors        |          |
|                 |                | 1-pole CA3                | TEF3             |   |                          |          |
| NS..            | 2 2 E          | 2 max.                    | or 1             | + | RV5                      | or RC5-1 |
| NS..            | 3 1 E          |                           |                  |   |                          |          |
| NS..            | 4 0 E          |                           |                  |   |                          |          |
| NS..            | 4 4 E          | -                         | -                |   | RV5                      | or RC5-1 |
| NS..            | 5 3 E          |                           |                  |   |                          |          |
| NS..            | 6 2 E          |                           |                  |   |                          |          |
| NS..            | 7 1 E          |                           |                  |   |                          |          |
| NS..            | 8 0 E          |                           |                  |   |                          |          |
| NSL..           | 2 2 E          | 2 max.                    | or 1             | + | RV5                      | or RT5   |
| NSL..           | 3 1 E          |                           |                  |   |                          |          |
| NSL..           | 4 0 E          |                           |                  |   |                          |          |
| NSL..           | 4 4 E          | -                         | -                |   | RV5                      | or RT5   |
| NSL..           | 5 3 E          |                           |                  |   |                          |          |
| NSL..           | 6 2 E          |                           |                  |   |                          |          |
| NSL..           | 7 1 E          |                           |                  |   |                          |          |
| NSL..           | 8 0 E          |                           |                  |   |                          |          |

# NS/L 4 & 8 pole, spring terminated

## Accessory fitting details

### Contactor relays and main accessories

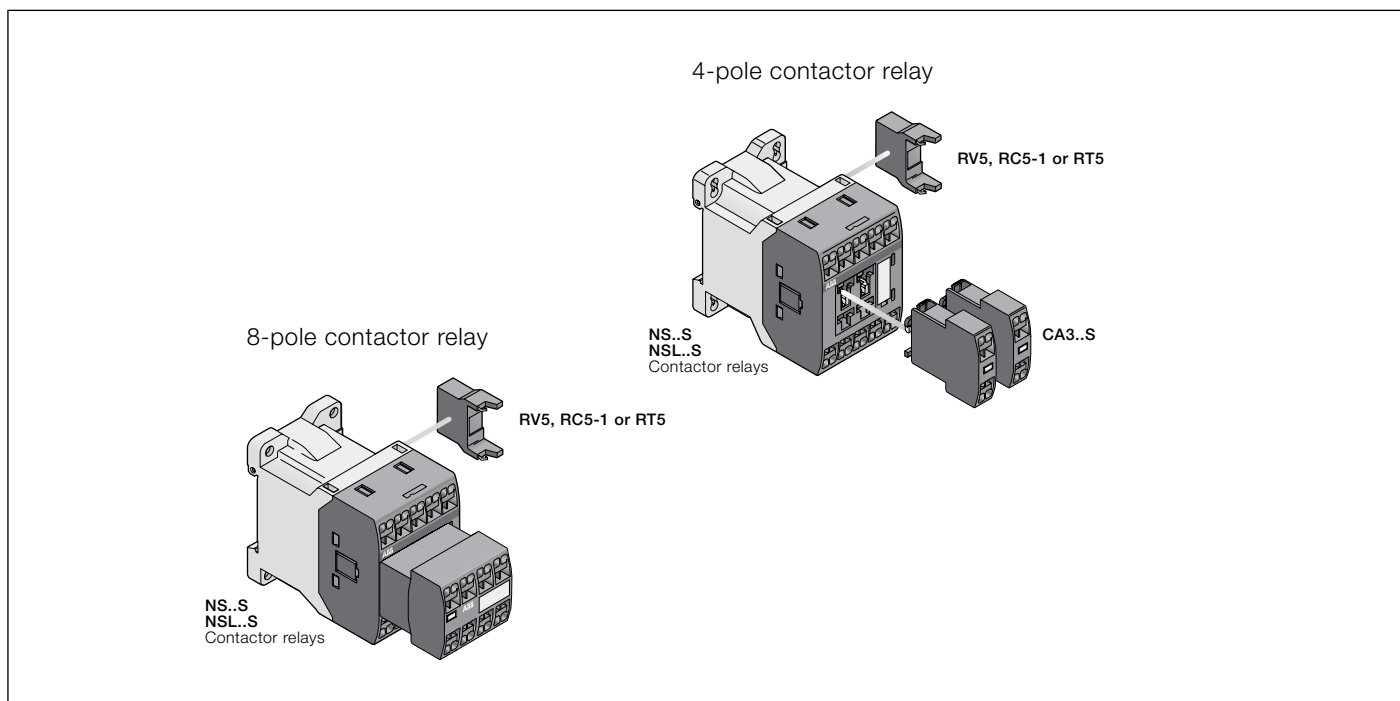

6

### Main accessory fitting details

| Contactor types | Main poles | Front-mounted accessories |        | Side-mounted accessories |     |          |
|-----------------|------------|---------------------------|--------|--------------------------|-----|----------|
|                 |            | Auxiliary contact blocks  |        | Surge suppressors        |     |          |
| NS..S           | 2 2 E      | 1-pole CA3..S             | 2 max. | +                        | RV5 | or RC5-1 |
| NS..S           | 3 1 E      |                           |        |                          |     |          |
| NS..S           | 4 0 E      |                           |        |                          |     |          |
| NS..S           | 4 4 E      | -                         |        |                          | RV5 | or RC5-1 |
| NS..S           | 5 3 E      |                           |        |                          |     |          |
| NS..S           | 6 2 E      |                           |        |                          |     |          |
| NS..S           | 7 1 E      |                           |        |                          |     |          |
| NS..S           | 8 0 E      |                           |        |                          |     |          |
| NSL..S          | 2 2 E      | 1-pole CA3..S             | 2 max. | +                        | RV5 | or RT5   |
| NSL..S          | 3 1 E      |                           |        |                          |     |          |
| NSL..S          | 4 0 E      |                           |        |                          |     |          |
| NSL..S          | 4 4 E      | -                         |        |                          | RV5 | or RT5   |
| NSL..S          | 5 3 E      |                           |        |                          |     |          |
| NSL..S          | 6 2 E      |                           |        |                          |     |          |
| NSL..S          | 7 1 E      |                           |        |                          |     |          |
| NSL..S          | 8 0 E      |                           |        |                          |     |          |

## Auxiliary contact blocks & interlocks NF(Z), NS/L & K/C6



CA4-10 CA4-22N



CAL4-11 CA3-10



CAF6-11K



CA6-11K



CA6-11K-P



VM4



BB4

### Ordering details (1)

| For contactor relays | Auxiliary contacts |  | Catalog number |
|----------------------|--------------------|--|----------------|
|                      |                    |  |                |

### Front-mounted instantaneous auxiliary contact blocks

|                                 | NF(Z) | NS/L | K/C6 | Catalog number |
|---------------------------------|-------|------|------|----------------|
| NF(Z), 4-pole                   | 1     | 0    | -    | CA4-10         |
|                                 | 0     | 1    | -    | CA4-01         |
|                                 | 4     | 0    | -    | CA4-40N        |
|                                 | 3     | 1    | -    | CA4-31N        |
|                                 | 2     | 2    | -    | CA4-22N        |
| NF(Z)40E only                   | 1     | 3    | -    | CA4-13N        |
|                                 | 0     | 4    | -    | CA4-04N        |
| NS/L, 4-pole                    | 1     | 0    | -    | CA3-10         |
|                                 | 0     | 1    | -    | CA3-01         |
| NS/L, 4-pole, spring terminated | 1     | 0    | -    | CA3-10S        |
|                                 | 0     | 1    | -    | CA3-01S        |
| K/C6, 4-pole                    | 1     | 1    | -    | CAF6-11K       |
|                                 | 2     | 0    | -    | CAF6-20K       |
|                                 | 0     | 2    | -    | CAF6-02K       |

### Front-mounted auxiliary contact blocks with N.O. leading (early make) contact & N.C. lagging (late break) contact

| NF(Z), 4-pole | N.O. | N.C. | Catalog number |
|---------------|------|------|----------------|
| -             | -    | 1    | CC4-10         |
| -             | -    | 0    | CC4-01         |

### Side-mounted instantaneous auxiliary contact blocks

|                    | NF(Z) | NS/L | K/C6 | Catalog number |
|--------------------|-------|------|------|----------------|
| NF(Z), 4- & 8-pole | 1     | 1    | -    | CAL4-11        |
| K/C6, 4-pole       | 1     | 1    | -    | CA6-11K        |
| K/C6...F, 4-pole   | 1     | 1    | -    | CA6-11K-F      |
| K/C6...P, 4-pole   | 1     | 1    | -    | CA6-11K-P      |

### Mechanical interlocks

| For control relays |            | Catalog number |
|--------------------|------------|----------------|
| Left side          | Right side |                |
| NF(Z)              | NF(Z)      | VM4            |
| NS/L               | NS/L       | VM3            |

NOTE: Includes two fixing clips.

### Mechanical & electrical interlocks

| For control relays |            | Catalog number |
|--------------------|------------|----------------|
| Left side          | Right side |                |
| NF(Z)              | NF(Z)      | VEM4           |

### Fixing clips

| For control relays |  | Catalog number |
|--------------------|--|----------------|
| NF(Z)              |  | BB4            |
| NS/L               |  | BB3            |

1) See accessory fitting details for maximum quantities.

## Surge suppression for control relay coils

### NS/L & K/C6

**NOTE: Surge suppression integral for NF / NFZ and AC operated K6 control relays; no accessory required.**

#### Description

The operation of inductive circuits causes overvoltages, in particular on opening the contactor coil. The electromagnetic energy stored in the coil during contactor closing is restored on opening in the form of surges, the slope and amplitude of which may rise to several kilovolts. A number of drawbacks are observed ranging from interference on the electronic devices to the breakdown of insulators and even the destruction of certain sensitive components. The graph opposite reproduces the oscillogram showing voltage discharges at the terminals of a 42 V / 50 Hz coil without peak clipping. The coil was switched by 8 series-connected poles of a contactor relay. Following a burst of discharges with a very steep slope, a damped oscillation emerges with a peak value of 3500 V.

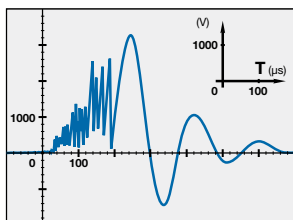

#### Overvoltage Factor

The overvoltage factor  $k$  is defined as the ratio of the maximum overvoltage peak value  $\hat{U}_s$  to the peak value  $\hat{U}_c$  of the coil rated control voltage  $U_c$ :

$$k = \frac{\hat{U}_s \text{ max.}}{\hat{U}_c} \quad \text{in DC} \quad k = \frac{\hat{U}_s \text{ max.}}{U_c} \quad \text{in AC} \quad k = \frac{\hat{U}_s \text{ max.}}{U_c \sqrt{2}}$$

For example the following is obtained for the above graph:  $k = \frac{3500}{42 \sqrt{2}} \approx 60$

To reduce the harmful effects of these overvoltages, ABB has developed a range of surge suppressors designed to reduce the  $k$  factor defined above and to limit or even completely eliminate the high pre-damping voltage frequencies. Each case is different, but the technical data tolerances and generous sizing of parts have enabled us to reduce the number of variants.

We have chosen the following solutions: transil diodes, varistors and RC blocks.

Note: A varistor is a resistor whose value decreases to a very large extent when a certain voltage is applied at its terminals.



RV5



RC5-1



RT5

#### Ordering details

| For<br>contactor relays | Rated control circuit<br>voltage - $U_c$ |    |    | Catalog<br>number |
|-------------------------|--|----|----|-------------------|
|                         | V  | AC | DC |                   |
| NS, NSL                 | 24...50                                  | ●  | ●  | RV5/50            |
|                         | 50...133                                 | ●  | ●  | RV5/133           |
|                         | 110...250                                | ●  | ●  | RV5/250           |
|                         | 250...440                                | ●  | ●  | RV5/440           |
| NS                      | 24...50                                  | ●  | -  | RC5-1/50          |
|                         | 50...133                                 | ●  | -  | RC5-1/133         |
|                         | 110...250                                | ●  | -  | RC5-1/250         |
|                         | 250...440                                | ●  | -  | RC5-1/440         |
| NSL                     | 12...32                                  | -  | ●  | RT5/32            |
|                         | 25...65                                  | -  | ●  | RT5/65            |
|                         | 50...90                                  | -  | ●  | RT5/90            |
|                         | 77...150                                 | -  | ●  | RT5/150           |
| KC6                     | 150...264                                | -  | ●  | RT5/264           |
|                         | 24...60                                  | -  | ●  | RV-BC6/60         |
| KC6...F<br>(2.8mm)      | 50...250                                 | -  | ●  | RV-BC6/250        |
|                         | 380                                      | -  | ●  | RV-BC6/380        |
|                         | 24...60                                  | -  | ●  | RV-BC6-F/60       |
|                         | 50...250                                 | -  | ●  | RV-BC6-F/250      |
|                         | 380                                      | -  | ●  | RV-BC6-F/380      |

#### Main dimensions mm, inches



RV-BC6/250

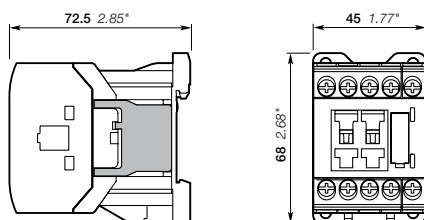







**Easy connection to the coil terminals**  
(parallel mounting)  
Clip-on for both fixing and connection.

**No additional space**  
Clipped onto the right side part of the contactor base without changing contactor overall dimensions and keeping a free access to coil terminals.

# Electronic timers NF(Z) & NS/L, 4 pole

## Ordering details

| For contactors,<br>contactor relays | Time delay<br>range<br>selected by switch  | Delay<br>type | Rated control<br>circuit voltage<br>Uc<br><br>V 50/60 Hz or DC | Auxiliary<br>contacts   |   | Catalog<br>number |
|-------------------------------------|--|---------------|--|---|---|-------------------|
|                                     |  |               |  |  |  |                   |
| NS(L)                               | 0.1...1 s   | ON-delay      | 24...240   | 1   | 1   | TEF3-ON           |
|                                     | 1...10 s    | OFF-delay     | 24...240   | 1   | 1   | TEF3-OFF          |
| NF(Z)                               | 10...100 s  | ON-delay      | 24...240   | 1   | 1   | TEF4-ON           |
|                                     | 10...100 s  | OFF-delay     | 24...240   | 1   | 1   | TEF4-OFF          |



TEF3



TEF4

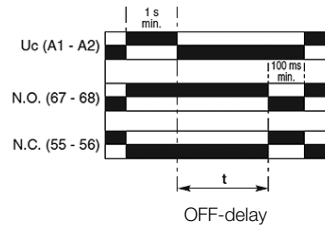
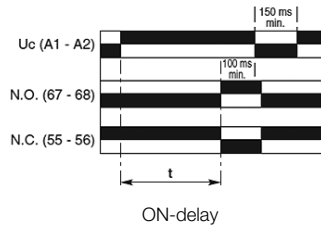

# Function markers, protective covers & coil terminal blocks

## NF(Z), NS/L & K/C6



LDC4



BX4



LT6-B



BA4

### Ordering details

|                    |                |
|--------------------|----------------|
| For control relays | Catalog number |
|--------------------|----------------|

### Additional coil terminal block

Additional coil terminal block for a bottom access to the coil terminals of contactors or contactor relays.

|    |      |
|----|------|
| NF | LDC4 |
|----|------|

### Protective covers

Sealable and transparent protective covers BX4 and non-removable BX4-CA to protect the devices against accidental contact.

|   |        |
|---|--------|
| All 1-stack contactors and contactor relays             | BX4    |
| For 4-pole CA4 and 2-pole CAT4 auxiliary contact blocks | BX4-CA |
| For control relays K/C6                                 | LT6-B  |

### Function markers

Box of 16 blank cards (16 markers by card) printable on HTP500 thermal transfer printer and AMS 500 marking table to identify your contactors, overload relays or manual motor starters.

Marker dimensions: 7 x 20 mm (.276" x .787").

|                                 |                 |
|---------------------------------|-----------------|
| Box of 16 blank cards           | BA4             |
| AMS 500 support plate for 8 BA4 | XUSP02633       |
| HTP500 support plate            | 1SNA235712R2400 |

# Terminal marking & positioning

## NF(Z), 4 & 8 pole

### Control relays

#### Standard devices without addition of auxiliary contacts

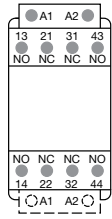

NF(Z)22E

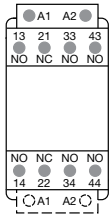

NF(Z)31E

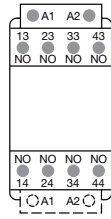

NF(Z)40E

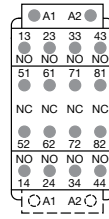

NF(Z)44E

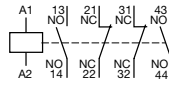

NF(Z)22E

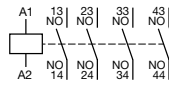

NF(Z)40E

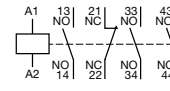

NF(Z)31E

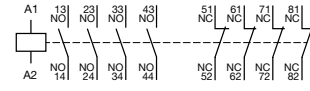

NF(Z)44E

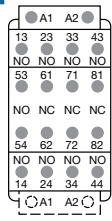

NF(Z)53E

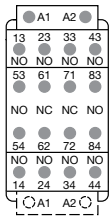

NF(Z)62E

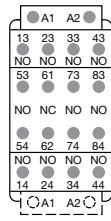

NF(Z)71E

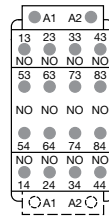

NF(Z)80E

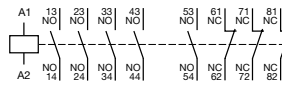

NF(Z)53E

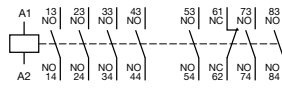

NF(Z)71E

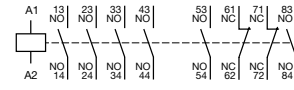

NF(Z)62E

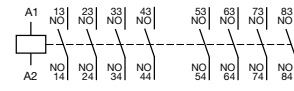

NF(Z)80E

#### Other possible contact combinations with auxiliary contacts

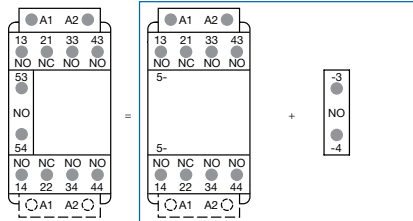

Combination 41 = NF(Z)31E + CA4-10

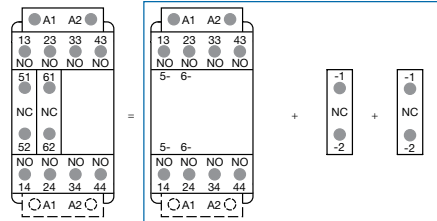

Combination 42 = NF(Z)40E + CA4-01+CA4-01

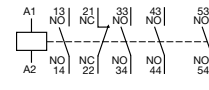

Combination 41 E

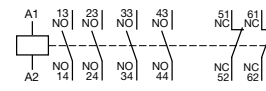

Combination 42 E

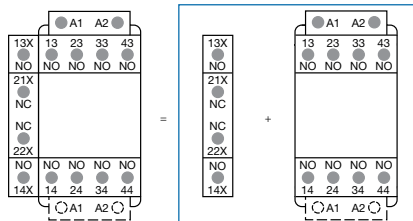

Combination 51 = CAL4-11 + NF(Z)40E

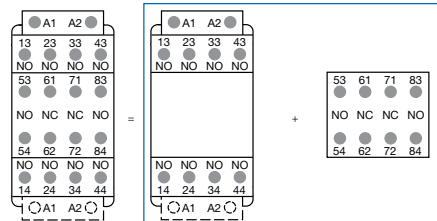

Combination 62 = NF(Z)40E + CA4-22N

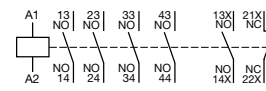

Combination 51 E

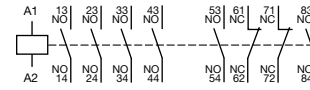

Combination 62 E

Note: Only NF(Z)Z contactor relays with DC control voltage 12...20 V DC need to respect the connection polarities indicated close to the coil terminals: A1+ for the positive pole and A2- for the negative pole.



# Terminal marking & positioning

## CA4, CC4, CAL4 & CAT4

### Auxiliary contacts

#### 1-pole auxiliary contacts

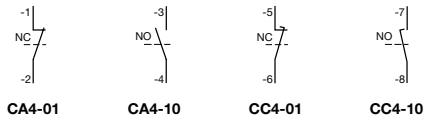

#### 2-pole auxiliary contacts

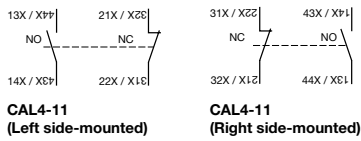

#### 4-pole auxiliary contacts

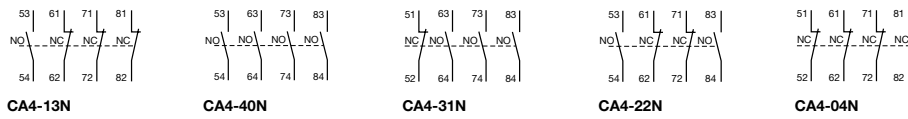

# Terminal marking & positioning

## NS/L 4 & 8 pole & CA3

### Control relays & auxiliary contacts

#### Standard devices without addition of auxiliary contact blocks

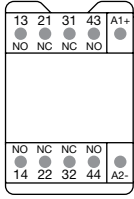

NS/L22E/S

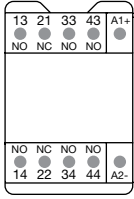

NS/L31E/S

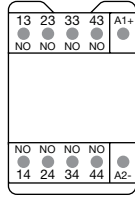

NS/L40E/S

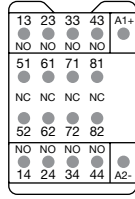

NS/L44E/S

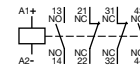

NS/L22E/S

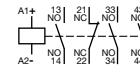

NS/L31E/S

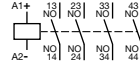

NS/L40E/S

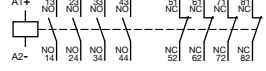

NS/L44E/S

6

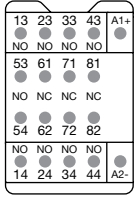

NS/L53E/S

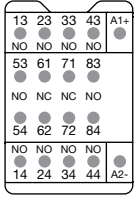

NS/L62E/S

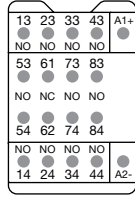

NS/L71E/S

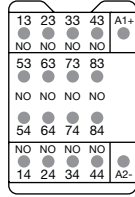

NS/L80E/S



NS/L53E/S

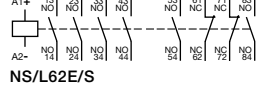

NS/L62E/S

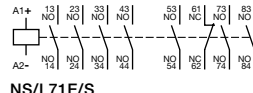

NS/L71E/S



NS/L80E/S

NOTE: For DC operated devices, polarity A1+, A2- must be respected.

#### Other possible contact combinations with auxiliary contact blocks added by the user

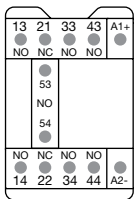

Combination 41E = NS/L31E/S + CA3-10/S

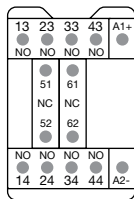
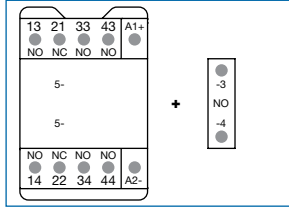

Combination 42E = NS/L40E/S + CA3-10/S + CA3-01/S

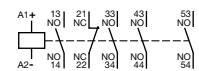
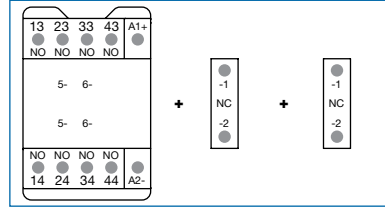

Combination 41E



Combination 42E

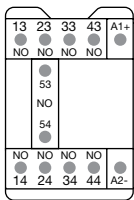

Combination 50E = NS/L40E/S + CA3-10/S

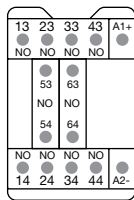
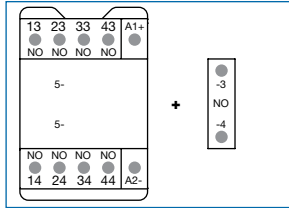

Combination 60E = NS/L40E/S + CA3-10/S + CA3-10/S

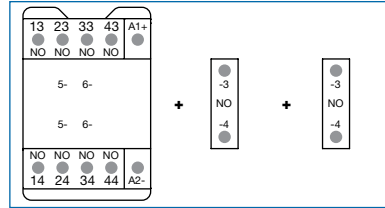

Combination 50E



Combination 60E

#### 1-pole auxiliary contact blocks

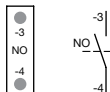

CA3-10/S

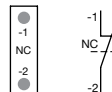

CA3-01/S

# Terminal marking & positioning

## K/C6, CA6 & CAF6

### Control relays & auxiliary contacts

#### Miniature control relays

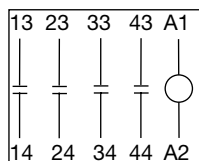

K6-40 E ...  
KC6-40 E ...

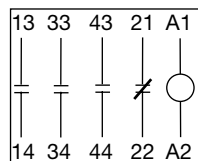

K6-31 Z ...  
KC6-31 Z ...

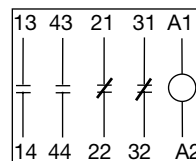

K6-22 Z ...  
KC6-22 Z ...

#### Side mounted auxiliary contact blocks

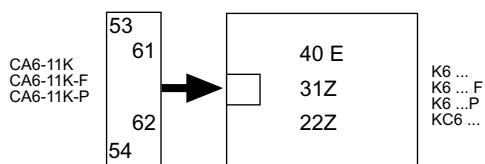

#### Front mounted auxiliary contact blocks

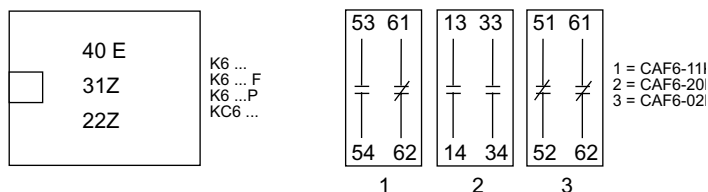

NOTE: Only side mounted type or front mounted type auxiliary contact blocks can be used at one time. Auxiliary contact blocks must not be mounted on Interface contactors, Interface control relays or contactors for connection to PLCs. Two CAF 6 front mounted auxiliary contact blocks can be installed on the mechanically interlocked contactors VB(C)6(7).

# IEC / UL / CSA technical data

## NF(Z), 4 & 8 pole

### Utilization characteristics

#### Contact utilization characteristics according to IEC

| Contactor relay types   | AC / DC operated   | NF(Z)   |
|---|--------------------|---|
| Standards   |                    | IEC 60947-1 / 60947-5-1 and EN 60947-1 / 60947-5-1  |
| Rated operational voltage U <sub>e</sub> max.                             |                    | 690 V   |
| Rated frequency (without derating)  |                    | 50 / 60 Hz  |
| Conventional free-air thermal current I <sub>th</sub> $\theta \leq 40$ °C |                    | 16 A  |
| I <sub>e</sub> / Rated operational current AC-15                          |                    |   |
| acc. to IEC 60947-5-1   | 24-127 V 50/60 Hz  | 6 A   |
|   | 220-240 V 50/60 Hz | 4 A   |
|   | 400-440 V 50/60 Hz | 3 A   |
|   | 500 V 50/60 Hz     | 2 A   |
|   | 690 V 50/60 Hz     | 2 A   |
| Rated making capacity AC-15   |                    | 10 x I <sub>e</sub> AC-15 acc. to IEC 60947-5-1   |
| Rated breaking capacity AC-15   |                    | 10 x I <sub>e</sub> AC-15 acc. to IEC 60947-5-1   |
| I <sub>e</sub> / Rated operational current DC-13                          |                    |   |
| acc. to IEC 60947-5-1   | 24 V DC            | 6 A / 144 W   |
|   | 48 V DC            | 2.8 A / 134 W   |
|   | 72 V DC            | 1 A / 72 W  |
|   | 110 V DC           | 0.55 A / 60 W   |
|   | 125 V DC           | 0.55 A / 69 W   |
|   | 220 V DC           | 0.27 A / 60 W   |
|   | 250 V DC           | 0.27 A / 68 W   |
|   | 400 V DC           | 0.15 A / 60 W   |
|   | 500 V DC           | 0.13 A / 65 W   |
|   | 600 V DC           | 0.1 A / 60 W  |
| Short-circuit protection device gG type fuse                              |                    | 10 A  |
| Rated short-time withstand current I <sub>sc</sub>                        | for 1.0 s          | 100 A   |
|   | for 0.1 s          | 140 A   |
| Minimum switching capacity  |                    | 12 V / 3 mA   |
| with failure rate acc. to IEC 60947-5-4                                   |                    | 10 <sup>-7</sup>  |
| Non-overlapping time between N.O. and N.C. contacts                       |                    | ≥ 2 ms  |
| Power dissipation per pole at 6 A   |                    | 0.1 W   |
| Max. electrical switching frequency                                       | AC-15              | 1200 cycles/h   |
|   | DC-13              | 900 cycles/h  |
| Mechanically linked contacts  |                    | Built-in N.O. or N.C. auxiliary contacts and additional N.O. or N.C. auxiliary contacts (CA4, CAL4 aux. contact blocks) are mechanically linked contacts. |
| acc. to annex L of IEC 60947-5-1  |                    |   |

#### Contact utilization characteristics according to UL / CSA

| Contactor relay types                  | AC / DC operated | NF(Z)                  |
|--|------------------|------------------------|
| Standards                              |                  | UL 508, CSA C22.2 N°14 |
| Max. operational voltage               |                  | 600 V AC, 600 V DC     |
| Pilot duty                             |                  | A600, Q600             |
| AC thermal rated current               |                  | 10 A                   |
| AC maximum volt-ampere making          |                  | 7200 VA                |
| AC maximum volt-ampere breaking        |                  | 720 VA                 |
| DC thermal rated current               |                  | 2.5 A                  |
| DC maximum volt-ampere making-breaking |                  | 69 VA                  |

# General technical data

## NF(Z) 4 & 8 pole

### Coil, mounting & operating characteristics

#### General technical data

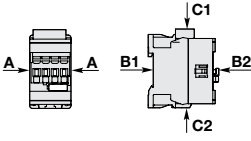
|   |                  |  |
|---|------------------|--|
| Contactor types   | AC / DC operated | NF(Z)  |
| Rated insulation voltage $U_i$  |                  |  |
| acc. to IEC 60947-5-1   |                  | 690 V  |
| acc. to UL / CSA  |                  | 600 V  |
| Rated impulse withstand voltage $U_{imp}$   |                  | 6 kV   |
| Electromagnetic compatibility   |                  | Devices complying with IEC 60947-1 / EN 60947-1 - Environment A                        |
| Ambient air temperature close to contactor  |                  |  |
| Operation in free air   |                  | -40...+70 °C   |
| Storage   |                  | -60...+80 °C   |
| Climatic withstand  |                  | Category B according to IEC 60947-1 Annex Q  |
| Maximum operating altitude (without derating)                                     |                  | 3000 m   |
| Mechanical durability   |                  |  |
| Number of operating cycles  |                  | 20 millions operating cycles   |
| Max. switching frequency  |                  | 6000 cycles/h  |
| Shock withstand   |                  |  |
| acc. to IEC 60068-2-27 and EN 60068-2-27  |                  |  |
| Mounting position 1   |                  |  |
|  | Shock direction  | 1/2 sinusoidal shock for 11 ms: no change in contact position, closed or open position |
|   | A                | 30 g   |
|   | B1               | 25 g closed position / 5 g open position   |
|   | B2               | 15 g   |
|   | C1               | 25 g   |
|   | C2               | 25 g   |
| Vibration withstand   |                  |  |
| acc. to IEC 60068-2-6   |                  | 5...300 Hz<br>4 g closed position / 2 g open position                                  |

#### Magnet system characteristics

|  |                                     |  |
|--|-------------------------------------|--|
| Contactor relay types                      | AC / DC operated                    | NF(Z)  |
| Coil operating limits                      | AC supply                           | At $\theta \leq 60$ °C $0.85 \times U_c \text{ min...} 1.1 \times U_c \text{ max.}$  |
| acc. to IEC 60947-5-1                      |                                     | At $\theta \leq 70$ °C $0.85 \times U_c \text{ min...} U_c \text{ max.}$   |
|  | DC supply                           | At $\theta \leq 60$ °C $0.85 \times U_c \text{ min...} 1.1 \times U_c \text{ max.}$  |
|  |                                     | At $\theta \leq 70$ °C (AF) $0.85 \times U_c \text{ min...} U_c \text{ max.}$ - (NFZ) $0.85 \times U_c \text{ min...} 1.1 \times U_c \text{ max.}$ |
| AC control voltage                         | Rated control circuit voltage $U_c$ | 24...500 V AC  |
| 50/60 Hz                                   | Coil consumption                    | Average pull-in value<br>(NF) 50 VA - (NFZ) 16 VA  |
|  |                                     | Average holding value<br>(NF) 2.2 VA / 2 W - (NFZ) 1.7 VA / 1.5 W  |
| DC control voltage                         | Rated control circuit voltage $U_c$ | 12...500 V DC  |
|  | Coil consumption                    | Average pull-in value<br>(NF) 50 W - (NFZ) 12...16 W   |
|  |                                     | Average holding value<br>(NF) 2 W - (NFZ) 1.7 W  |
| PLC-output control                         |                                     | (NFZ) $\geq 500$ mA 24 V DC  |
| Drop-out voltage                           |                                     | $\leq 60$ % of $U_c \text{ min.}$  |
| Voltage sag immunity acc. to SEMI F47-0706 |                                     | (NFZ) conditions of use on request   |
| Dips withstand                             |                                     |  |
| -20 °C $\leq \theta \leq$ +60 °C           |                                     | (NFZ) 22 ms average  |
| Operating time                             |                                     |  |
| Between coil energization and:             | N.O. contact closing                | 40...95 ms   |
|  | N.C. contact opening                | 38...90 ms   |
| Between coil de-energization and:          | N.O. contact opening                | 11...95 ms   |
|  | N.C. contact closing                | 13...98 ms   |

#### Mounting characteristics

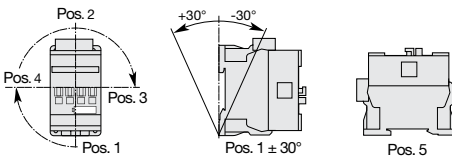







|                    |  |  |
|--------------------|--|--|
| Contactor types    | AC / DC operated                         | NF(Z)  |
| Mounting positions |  |            |
|                    |  | Max. add-on N.C. auxiliary contacts:<br>see accessory fitting details for a NF contactor relay |
| Mounting distances |  | The contactor relays can be assembled side by side.  |
| Fixing             | On rail according to IEC 60715, EN 60715 | 35 x 7.5 mm or 35 x 15 mm  |
|                    | By screws (not supplied)                 | 2 x M4 screws placed diagonally  |

## General technical data

### NF(Z), 4 & 8 pole

### Terminal characteristics

#### Connecting characteristics

|   |   |   |                            |
|---|---|---|----------------------------|
| Contactor types   | AC / DC operated  | NF(Z)   |                            |
| Main terminals  |   |  |                            |
|   |   | Screw terminals with cable clamp  |                            |
| Connection capacity (min. ... max.)   |   |   |                            |
| 6   | Pole and coil terminals   |   |                            |
|   |  | Rigid   |                            |
|   | 1 x   | 1...2.5 mm <sup>2</sup>   |                            |
|   |  | 2 x   | 1...2.5 mm <sup>2</sup>    |
|   |  | Flexible with non insulated ferrule   |                            |
|   | 1 x   | 0.75...2.5 mm <sup>2</sup>  |                            |
|   |  | 2 x   | 0.75...2.5 mm <sup>2</sup> |
|   |  | Flexible with insulated ferrule   |                            |
|   | 1 x   | 0.75...2.5 mm <sup>2</sup>  |                            |
|   |  | 2 x   | 0.75...1.5 mm <sup>2</sup> |
|  | Lugs  | L < 8 mm  |                            |
| Connection capacity acc. to UL/CSA  |   | 1 or 2 x AWG 18...14  |                            |
| Stripping length  |   | 10 mm   |                            |
| Tightening torque   |   |   |                            |
| Pole terminals  |   | 1.2 Nm / 11 lb.in   |                            |
| Coil terminals  |   | 1.2 Nm / 11 lb.in   |                            |
| Degree of protection  |   |   |                            |
| acc. to IEC 60947-1 / EN 60947-1 and IEC 60529 / EN 60529                         |   |   |                            |
| All terminals   |   | IP20  |                            |
| Screw terminals   |   |   |                            |
| All terminals   |   | Delivered in open position, screws of unused terminals must be tightened          |                            |
|   |   | M3.5  |                            |
| Screwdriver type  |   | Flat Ø 5.5 / Pozidriv 2   |                            |

## IEC / UL / CSA technical data

### NS/L, 4 & 8 pole, screw terminated

### Utilization characteristics

#### Contact utilization characteristics according to IEC

|  |   |               |
|--|---|---------------|
| Contactor relay types  | AC operated   | NS            |
|  | DC operated   | NSL           |
| Standards  | IEC 60947-5-1 and EN 60947-5-1  |               |
| Rated operational voltage $U_e$ max.                               | 690 V   |               |
| Rated frequency (without derating)                                 | 50 / 60 Hz  |               |
| Conventional free-air thermal current $I_{th} - \theta \leq 40$ °C | 10 A  |               |
| $I_e$ / Rated operational current AC-15                            |   |               |
| acc. to IEC 60947-5-1  | 24-127 V 50/60 Hz   | 6 A           |
|  | 220-240 V 50/60 Hz  | 4 A           |
|  | 400-440 V 50/60 Hz  | 3 A           |
|  | 500 V 50/60 Hz  | 2 A           |
|  | 690 V 50/60 Hz  | 2 A           |
| Making capacity AC-15  | 10 x $I_e$ AC-15 acc. to IEC 60947-5-1  |               |
| Breaking capacity AC-15  | 10 x $I_e$ AC-15 acc. to IEC 60947-5-1  |               |
| $I_e$ / Rated operational current DC-13                            |   |               |
| acc. to IEC 60947-5-1  | 24 V DC   | 6 A / 144 W   |
|  | 48 V DC   | 2.8 A / 134 W |
|  | 72 V DC   | 1 A / 72 W    |
|  | 110 V DC  | 0.55 A / 60 W |
|  | 125 V DC  | 0.55 A / 69 W |
|  | 220 V DC  | 0.27 A / 60 W |
|  | 250 V DC  | 0.27 A / 68 W |
| Short-circuit protection device for contactors                     |   |               |
| $U_e \leq 500$ V AC - gG type fuse                                 | 10 A  |               |
| Rated short-time withstand current $I_{sw}$                        | for 1.0 s   | 100 A         |
|  | for 0.1 s   | 140 A         |
| <b>Minimum switching capacity</b>                                  | 12 V / 3 mA   |               |
| with failure rate acc. to IEC 60947-5-4                            | 10 <sup>-7</sup>  |               |
| Non-overlapping time between N.O. and N.C. contacts                | 1.5 ms  |               |
| Power dissipation per pole at 6 A                                  | 0.1 W   |               |
| Max. electrical switching frequency                                | AC-15   | 1200 cycles/h |
|  | DC-13   | 900 cycles/h  |
| Mechanically linked contacts                                       | Built-in N.O. or N.C. auxiliary contacts and additional N.O. or N.C. auxiliary contacts (CA3 aux. contact blocks) are mechanically linked contacts. |               |
| acc. to annex L of IEC 60947-5-1                                   |   |               |

#### Contact utilization characteristics according to UL / CSA

|  |                        |     |
|--|------------------------|-----|
| Contactor relay types                  | AC operated            | NS  |
|  | DC operated            | NSL |
| Standards                              | UL 508, CSA C22.2 N°14 |     |
| Max. operational voltage               | 600 V AC, 250 V DC     |     |
| Pilot duty                             | A600, Q300             |     |
| AC thermal rated current               | 10 A                   |     |
| AC maximum volt-ampere making          | 7200 VA                |     |
| AC maximum volt-ampere breaking        | 720 VA                 |     |
| DC thermal rated current               | 2.5 A                  |     |
| DC maximum volt-ampere making-breaking | 69 VA                  |     |

## General technical data

### NS/L, 4 & 8 pole, screw terminated

### Coil & mounting characteristics

#### Magnet system characteristics for NS contactor relays

|   |                                     |   |                |
|---|-------------------------------------|---|----------------|
| Contactor relay types   | AC operated                         | NS  |                |
| Coil operating limits<br>acc. to IEC 60947-5-1                                      | AC supply                           |   |                |
| AC control voltage  | Rated control circuit voltage $U_c$ | 0.85...1.1 x $U_c$ (at $\theta \leq 60^\circ\text{C}$ ); $U_c$ (at $\theta \leq 70^\circ\text{C}$ ) |                |
|   | at 50 Hz                            | 24...415 V  |                |
|   | at 60 Hz                            | 24...415 V  |                |
| Coil consumption  | <b>Average pull-in value</b>        | 50 Hz   | 33 VA          |
|   |                                     | 60 Hz   | 33 VA          |
|   |                                     | 50/60 Hz  | 33 VA          |
|   | <b>Average holding value</b>        | 50 Hz   | 6.5 VA / 1.5 W |
|   |                                     | 60 Hz   | 5 VA / 1.2 W   |
| 50/60 Hz  |                                     | 6.5 VA / 1.5 W  |                |
| Drop-out voltage  |                                     | Approx. 30...50 % of $U_c$  |                |
| Operating time  |                                     |   |                |
| Between coil energization and:  | N.O. contact closing                | 9...24 ms   |                |
|   | N.C. contact opening                | 6...18 ms   |                |
| Between coil de-energization and:   | N.O. contact opening (1)            | 5...19 ms   |                |
|   | N.C. contact closing (1)            | 7...22 ms   |                |
| (1) The use of RC5-1 surge suppressor increases opening time by a factor of 2 to 3. |                                     |   |                |

#### Magnet system characteristics for NSL contactor relays

|   |                                     |   |       |
|---|-------------------------------------|---|-------|
| Contactor relay types   | DC operated                         | NSL   |       |
| Coil operating limits<br>acc. to IEC 60947-5-1  | DC supply                           |   |       |
| DC control voltage  | Rated control circuit voltage $U_c$ | 0.85...1.1 x $U_c$ (at $\theta \leq 60^\circ\text{C}$ ); $U_c$ (at $\theta \leq 70^\circ\text{C}$ ) |       |
|   | Coil consumption                    | 12...240 V DC   |       |
|   | <b>Average pull-in value</b>        | 3 W   |       |
|   | <b>Average holding value</b>        | 3 W   |       |
| Drop-out voltage  |                                     | Approx. 10...40 % of $U_c$  |       |
| Coil time constant  | Open                                | L/R   | 12 ms |
|   | Closed                              | L/R   | 40 ms |
| Operating time  |                                     |   |       |
| Between coil energization and:  | N.O. contact closing                | 36...59 ms  |       |
|   | N.C. contact opening                | 31...53 ms  |       |
| Between coil de-energization and:   | N.O. contact opening (1)            | 13...17 ms  |       |
|   | N.C. contact closing (1)            | 15...20 ms  |       |
| (1) The use of RT5 surge suppressor increases opening time by a factor of 1.1 to 1.2. |                                     |   |       |

#### Mounting characteristics and conditions for use

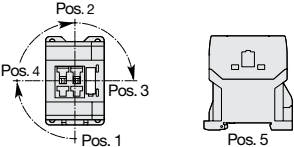
|                       |   |                                 |
|-----------------------|---|---------------------------------|
| Contactor relay types | AC operated   | NS                              |
|                       | DC operated   | NSL                             |
| Mounting positions    |  |                                 |
| Mounting distances    | The contactor relays can be assembled side by side.                                 |                                 |
| Fixing                | On rail according to IEC 60715, EN 60715  | 35 x 7.5 mm or 35 x 15 mm       |
|                       | By screws (not supplied)  | 2 x M4 screws placed diagonally |



# General technical data

## NS/L, 4 & 8 pole, screw terminated



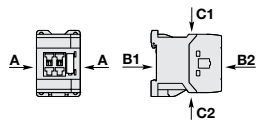

### Operating & terminal characteristics

#### General technical data

|  |                 |  |
|--|-----------------|--|
| Contactor relay types                            | AC operated     | NS   |
|  | DC operated     | NSL  |
| Rated insulation voltage $U_i$                   |                 |  |
| acc. to IEC 60947-5-1                            |                 | 690 V  |
| acc. to UL / CSA                                 |                 | 600 V  |
| Rated impulse withstand voltage $U_{imp}$        |                 | 6 kV   |
| Ambient air temperature close to contactor relay |                 |  |
| Operation in free air                            |                 | -40...+70 °C   |
| Storage  |                 | -60...+80 °C   |
| Climatic withstand                               |                 | Category B according to IEC 60947-1 Annex Q  |
| Maximum operating altitude (without derating)    |                 | 3000 m   |
| Mechanical durability                            |                 |  |
| Number of operating cycles                       |                 | 20 millions operating cycles   |
| Max. switching frequency                         |                 | 3600 cycles/h  |
| Shock withstand                                  |                 | 1/2 sinusoidal shock for 11 ms: no change in contact position, closed or open position |
| acc. to IEC 60068-2-27 and EN 60068-2-27         | Shock direction | <b>NS contactor relays - AC operated</b>   <b>NSL contactor relays - DC operated</b>   |
| Mounting position 1                              | A               | 20 g   20 g closed position / 10 g open position                                       |
|  | B1              | 5 g   15 g closed position / 5 g open position   |
|  | B2              | 15 g   10 g  |
|  | C1              | 19 g closed position / 8 g open position   19 g closed position / 8 g open position    |
|  | C2              | 16 g closed position / 13 g open position   14 g closed position / 8 g open position   |
| Vibration withstand acc. to IEC 60068-2-6        |                 | 5...300 Hz / 3 g closed position / 2 g open position                                   |



#### Connecting characteristics

|   |                  |   |
|---|------------------|---|
| Contactor relay types   | AC operated      | NS  |
|   | DC operated      | NSL   |
| Main terminals  |                  | <br>Screw terminals with cable clamp |
| Connection capacity (min. ... max.)   |                  |   |
| Pole and coil terminals   |                  |   |
|  Rigid solid                         | 1 x              | 0.75...2.5 mm <sup>2</sup>  |
|   | 2 x              | 0.75...2.5 mm <sup>2</sup>  |
|  Flexible with non insulated ferrule | 1 x              | 0.75...2.5 mm <sup>2</sup>  |
|   | 2 x              | 0.75...2.5 mm <sup>2</sup>  |
|  Flexible with insulated ferrule     | 1 x              | 0.75...2.5 mm <sup>2</sup>  |
|   | 2 x              | 0.75...1.5 mm <sup>2</sup>  |
|  Lugs                                | L ≤              | 7.7 mm  |
|   | L >              | 3.2 mm  |
| Connection capacity acc. to UL / CSA  | 1 or 2 x         | AWG 18...14   |
| Stripping length  |                  | 9 mm  |
| Tightening torque   | Recommended      | 1.00 Nm / 9 lb.in   |
|   | Max.             | 1.20 Nm   |
| Degree of protection  |                  |   |
| acc. to IEC 60947-1 / EN 60947-1 and IEC 60529 / EN 60529   |                  |   |
| All terminals   |                  | IP20  |
| Screw terminals   |                  | Delivered in open position, screws of unused terminals must be tightened  |
| All terminals   |                  | M3  |
|   | Screwdriver type | Flat Ø 5.5 / Pozidriv 2   |

## IEC / UL / CSA technical data

### NS/L, 4 & 8 pole, spring terminated

### Utilization characteristics

#### Contact utilization characteristics according to IEC

|  |  |               |
|--|--|---------------|
| Contactor relay types  | AC operated  | NS..S         |
|  | DC operated  | NSL..S        |
| Standards  | IEC 60947-5-1 and EN 60947-5-1   |               |
| Rated operational voltage $U_e$ max.                                     | 690 V  |               |
| Rated frequency (without derating)                                       | 50 / 60 Hz   |               |
| Conventional free-air thermal current $I_{th} \theta \leq 40 \text{ °C}$ | 10 A   |               |
| le / Rated operational current AC-15                                     | 24-127 V 50/60 Hz  | 6 A           |
| acc. to IEC 60947-5-1  | 220-240 V 50/60 Hz   | 4 A           |
|  | 400-440 V 50/60 Hz   | 3 A           |
|  | 500 V 50/60 Hz   | 2 A           |
|  | 690 V 50/60 Hz   | 2 A           |
| Making capacity AC-15  | 10 x le AC-15 acc. to IEC 60947-5-1  |               |
| Breaking capacity AC-15  | 10 x le AC-15 acc. to IEC 60947-5-1  |               |
| le / Rated operational current DC-13                                     | 24 V DC  | 6 A / 144 W   |
| acc. to IEC 60947-5-1  | 48 V DC  | 2.8 A / 134 W |
|  | 72 V DC  | 1 A / 72 W    |
|  | 110 V DC   | 0.55 A / 60 W |
|  | 125 V DC   | 0.55 A / 69 W |
|  | 220 V DC   | 0.27 A / 60 W |
|  | 250 V DC   | 0.27 A / 68 W |
| Short-circuit protection device for contactors                           | 10 A   |               |
| $U_e \leq 500 \text{ V AC}$ - gG type fuse                               |  |               |
| Rated short-time withstand current $I_{cw}$                              | for 1.0 s  | 100 A         |
| at 40 °C ambient temperature, in free air from a cold state              | for 0.1 s  | 140 A         |
| Minimum switching capacity   | 12 V / 3 mA  |               |
| with failure rate acc. to IEC 60947-5-4                                  | 10 <sup>-7</sup>   |               |
| Non-overlapping time between N.O. and N.C. contacts                      | 1.5 ms   |               |
| Power dissipation per pole at 6 A  | 0.1 W  |               |
| Max. electrical switching frequency                                      | AC-15  | 1200 cycles/h |
|  | DC-13  | 900 cycles/h  |
| Mechanically linked contacts   | Built-in N.O. or N.C. auxiliary contacts and additional N.O. or N.C. auxiliary contacts (CA3..S aux. contact blocks) are mechanically linked contacts. |               |
| acc. to annex L of IEC 60947-5-1   |  |               |

#### Contact utilization characteristics according to UL / CSA

|  |                        |        |
|--|------------------------|--------|
| Contactor relay types                  | AC operated            | NS..S  |
|  | DC operated            | NSL..S |
| Standards                              | UL 508, CSA C22.2 N°14 |        |
| Max. operational voltage               | 600 V AC, 250 V DC     |        |
| Pilot duty                             | A600, Q300             |        |
| AC thermal rated current               | 10 A                   |        |
| AC maximum volt-ampere making          | 7200 VA                |        |
| AC maximum volt-ampere breaking        | 720 VA                 |        |
| DC thermal rated current               | 2.5 A                  |        |
| DC maximum volt-ampere making-breaking | 69 VA                  |        |

## General technical data

### NS/L, 4 & 8 pole, spring terminated

### Coil & mounting characteristics

#### Magnet system characteristics for NS..S contactor relays

|                                   |  |   |
|-----------------------------------|--|---|
| <b>Contactor relay types</b>      | AC operated                                  | <b>NS..S</b>  |
| <b>Coil operating limits</b>      | AC supply                                    |   |
| acc. to IEC 60947-5-1             |  | 0.85...1.1 x U <sub>c</sub> (at $\theta \leq 60^\circ\text{C}$ ); U <sub>c</sub> (at $\theta \leq 70^\circ\text{C}$ ) |
| <b>AC control voltage</b>         | Rated control circuit voltage U <sub>c</sub> |   |
|                                   | at 50 Hz                                     | 24...415 V  |
|                                   | at 60 Hz                                     | 24...415 V  |
| Coil consumption                  | Average pull-in value                        |   |
|                                   | 50 Hz  | 33 VA   |
|                                   | 60 Hz  | 33 VA   |
|                                   | 50/60 Hz                                     | 33 VA   |
|                                   | Average holding value                        |   |
| 50 Hz                             | 6.5 VA / 1.5 W                               |   |
| 60 Hz                             | 5 VA / 1.2 W                                 |   |
| 50/60 Hz                          | 6.5 VA / 1.5 W                               |   |
| <b>Drop-out voltage</b>           |  | Approx. 30...50 % of U <sub>c</sub>   |
| <b>Operating time</b>             |  |   |
| Between coil energization and:    | N.O. contact closing                         | 9...24 ms   |
|                                   | N.C. contact opening                         | 6...18 ms   |
| Between coil de-energization and: | N.O. contact opening (1)                     | 5...19 ms   |
|                                   | N.C. contact closing (1)                     | 7...22 ms   |
|                                   |  | (1) The use of RC5-1 surge suppressor increases opening time by a factor of 2 to 3.                                   |

#### Magnet system characteristics for NSL..S contactor relays

|  |                          |   |
|--|--------------------------|---|
| <b>Contactor relay types</b>                 | DC operated              | <b>NSL..S</b>   |
| <b>Coil operating limits</b>                 | DC supply                |   |
| acc. to IEC 60947-5-1                        |                          | 0.85...1.1 x U <sub>c</sub> (at $\theta \leq 60^\circ\text{C}$ ); U <sub>c</sub> (at $\theta \leq 70^\circ\text{C}$ ) |
| <b>DC control voltage</b>                    |                          |   |
| Rated control circuit voltage U <sub>c</sub> |                          | 12...240 V DC   |
| Coil consumption                             | Average pull-in value    | 3 W   |
|  | Average holding value    | 3 W   |
| <b>Drop-out voltage</b>                      |                          | Approx. 10...40 % of U <sub>c</sub>   |
| <b>Coil time constant</b>                    | Open                     | L/R 12 ms   |
|  | Closed                   | L/R 40 ms   |
| <b>Operating time</b>                        |                          |   |
| Between coil energization and:               | N.O. contact closing     | 36...59 ms  |
|  | N.C. contact opening     | 31...53 ms  |
| Between coil de-energization and:            | N.O. contact opening (1) | 13...17 ms  |
|  | N.C. contact closing (1) | 15...20 ms  |
|  |                          | (1) The use of RT5 surge suppressor increases opening time by a factor of 1.1 to 1.2.                                 |

#### Mounting characteristics and conditions for use

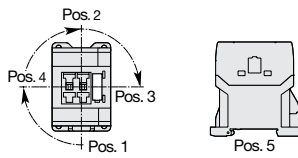
|                              |   |                                 |
|------------------------------|---|---------------------------------|
| <b>Contactor relay types</b> | AC operated   | <b>NS..S</b>                    |
|                              | DC operated   | <b>NSL..S</b>                   |
| <b>Mounting positions</b>    |  |                                 |
| <b>Mounting distances</b>    | The contactor relays can be assembled side by side.                                 |                                 |
| <b>Fixing</b>                | On rail according to IEC 60715, EN 60715  | 35 x 7.5 mm or 35 x 15 mm       |
|                              | By screws (not supplied)  | 2 x M4 screws placed diagonally |

## General technical data





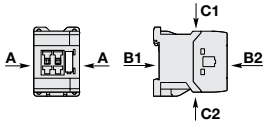

### NS/L, 4 & 8 pole, spring terminated

### Operating & terminal characteristics

#### General technical data

|  |                 |  |   |
|--|-----------------|--|---|
| Contactor relay types  | AC operated     | NS..S  |   |
|  | DC operated     | NSL..S   |   |
| Rated insulation voltage $U_i$   |                 | 690 V  |   |
| acc. to IEC 60947-5-1  |                 | 600 V  |   |
| acc. to UL / CSA   |                 | 600 V  |   |
| Rated impulse withstand voltage $U_{imp}$  |                 | 6 kV   |   |
| Ambient air temperature close to contactor relay                                 |                 |  |   |
| Operation in free air  |                 | -40...+70 °C   |   |
| Storage  |                 | -60...+80 °C   |   |
| <b>6 Climatic withstand</b>  |                 | Category B according to IEC 60947-1 Annex Q  |   |
| Maximum operating altitude (without derating)                                    |                 | 3000 m   |   |
| Mechanical durability  |                 |  |   |
| Number of operating cycles   |                 | 20 millions operating cycles   |   |
| Max. switching frequency   |                 | 3600 cycles/h  |   |
| Shock withstand  |                 | 1/2 sinusoidal shock for 11 ms: no change in contact position, closed or open position |   |
| acc. to IEC 60068-2-27 and EN 60068-2-27   | Shock direction |  |   |
| Mounting position 1  |                 | <b>NS contactor relays - AC operated</b>   | <b>NSL contactor relays - DC operated</b> |
|  | A               | 20 g   | 20 g closed position / 10 g open position |
|  | B1              | 5 g  | 15 g closed position / 5 g open position  |
|  | B2              | 15 g   | 10 g                                      |
|  | C1              | 19 g closed position / 8 g open position   | 19 g closed position / 8 g open position  |
|  | C2              | 16 g closed position / 13 g open position  | 14 g closed position / 8 g open position  |
| Vibration withstand  |                 | 5...300 Hz   |   |
| acc. to IEC 60068-2-6  |                 | 3 g closed position / 2 g open position  |   |

#### Connecting characteristics

|   |             |   |  |
|---|-------------|---|--|
| Contactor relay types   | AC operated | NS..S   |  |
|   | DC operated | NSL..S  |  |
| Main terminals  |             |  |  |
|   |             | Spring terminals  |  |
| Connection capacity (min. ... max.)   |             |   |  |
| Pole and coil terminals   |             |   |  |
|  Rigid solid                         | 1 x         | 0.75...2.5 mm <sup>2</sup>  |  |
|  Rigid solid                         | 2 x         | 0.75...2.5 mm <sup>2</sup>  |  |
|  Flexible with non insulated ferrule | 1 x         | 0.75...2.5 mm <sup>2</sup>  |  |
|  Flexible with non insulated ferrule | 2 x         | 0.75...2.5 mm <sup>2</sup>  |  |
|  Flexible with insulated ferrule     | 1 x         | 0.75...1.5 mm <sup>2</sup>  |  |
|  Flexible with insulated ferrule     | 2 x         | 0.75...1.5 mm <sup>2</sup>  |  |
| Connection capacity acc. to UL / CSA  | 1 or 2 x    | AWG 18...14   |  |
| Stripping length  |             | 10 mm   |  |
| Degree of protection  |             |   |  |
| acc. to IEC 60947-1 / EN 60947-1 and IEC 60529 / EN 60529   |             |   |  |
| All terminals   |             | IP20  |  |
| Screwdriver type  |             | Flat Ø 3.5  |  |

## IEC / UL / CSA technical data

### K/C6, 4 pole

### Utilization characteristics

#### Main pole – Utilization characteristics according to IEC

|   |                           |  |
|---|---------------------------|--|
| Contactor types   | AC operated               | K6   |
|   | DC operated               | KC6, TKC6  |
| Standards   |                           | IEC 60947-1 / 60947-5-1 and EN 60947-1 / 60947-5-1 |
| Rated operational voltage $U_{e\max}$   |                           | 690 V  |
| Rated frequency (without derating)  |                           | DC or 50 / 60 Hz                                   |
| Conventional free-air thermal current $I_{th} \text{ } \varnothing \leq 40 \text{ } ^\circ\text{C}$ |                           | 6 A  |
| $I_e$ / Rated operational current AC-15<br>acc. to IEC 60947-5-1                                    | 24 V 50/60 Hz             | 4 A  |
|   | 110-120 V 50/60 Hz        | 4 A  |
|   | 220-230-240 V 50/60<br>Hz | 4 A  |
|   | 380-400 V 50/60 Hz        | 3 A  |
|   | 440 V 50/60 Hz            | 3 A  |
| $I_e$ / Rated operational current DC-13<br>acc. to IEC 60947-5-1                                    | 480-500 V 50/60 Hz        | 2 A  |
|   | 24 V DC                   | 2.5 A  |
|   | 110 V DC                  | 0.7 A  |
|   | 220 - 240 V DC            | 0.4 A  |
| Short-circuit protection device for contactors $U_e \leq 500 \text{ V AC}$ , gG fuse type           |                           | 6 A  |
| Minimum switching capacity  |                           | 17 V / 5 mA  |
| Maximum electrical switching frequency  | AC-15                     | 600 cycles/h                                       |
|   | DC-13                     | 600 cycles/h                                       |

#### Main pole – Utilization characteristics according to UL / CSA

|                             |             |                        |
|-----------------------------|-------------|------------------------|
| Contactor types             | AC operated | K6                     |
|                             | DC operated | KC6                    |
| Standards                   |             | UL 508, CSA C22.2 No14 |
| Maximum operational voltage |             | 600 V AC               |
| Pilot duty                  |             | A600                   |

## General technical data

### K/C6, 4 pole

### Coil & operating characteristics

#### General technical data

|  |                                       |                                  |
|--|---------------------------------------|----------------------------------|
| Contactor relay types                            | AC operated                           | K6                               |
|  | DC operated                           | KC6                              |
| Rated insulation voltage $U_i$                   | acc. to IEC 60947-5-1                 | 690 V                            |
|  | acc. to UL/CSA                        | 600 V                            |
| Rated impulse withstand voltage $U_{imp}$        |                                       | 6 kV                             |
| Electromagnetic compatibility                    |                                       |                                  |
| Ambient air temperature close to contactor relay | Operation in free air                 | -25 ... +55 °C                   |
|  | Storage                               | -40 ... +80 °C                   |
| Climatic withstand                               |                                       | acc. to IEC 60068-2-30           |
| Maximum operating altitude (without derating)    |                                       | 2000 m                           |
| Mechanical durability                            |                                       | 10 <sup>7</sup> operating cycles |
| Resistance to shock                              |                                       | Half-sine                        |
|  | acc. IEC 60068-2-27 and EN 60068-2-27 | 15 g / 11ms                      |
|  | acc. to IEC/EN 60947-1 Annex. Q       | Category E                       |
| Resistance to vibrations                         |                                       | Sinusoidal                       |
|  | acc. IEC 60068-2-27 and EN 60068-2-27 | 5 g / 3 ... 150 Hz               |
|  | acc. to IEC/EN 60947-1 Annex. Q       | Kategorie E                      |

#### Magnet system characteristics for K6 contactor relays

|   |                       |                      |
|---|-----------------------|----------------------|
| Contactor relay types                       | AC operated           | K6                   |
| Coil operating limits acc. to IEC 60947-4-1 | AC supply             | 0.85 ... 1.1 x $U_C$ |
| AC control voltage                          |                       |                      |
| Coil consumption                            | Average pull-in value | 3.5 VA / 3.5 W       |
|   | Average holding value | 3.5 VA / 3.5 W       |
| Drop-out voltage in % of $U_C$ min.         |                       | Approx. 20 ... 75%   |

#### Magnet system characteristics for KC6, TKC6 contactor relays

|   |                       |                      |                      |
|---|-----------------------|----------------------|----------------------|
| Contactor relay types                       | DC operated           | KC6                  | TKC6                 |
| Coil operating limits acc. to IEC 60947-5-1 | DC supply             | 0.85 ... 1.1 x $U_C$ | See ordering details |
| DC control voltage                          |                       |                      |                      |
| Coil consumption                            | Average pull-in value | 3.5 VA / 3.5 W       | 5 VA / 5 W           |
|   | Average holding value | 3.5 VA / 3.5 W       | 5 VA / 5 W           |
| Drop-out voltage in % of $U_C$ min.         |                       | 10 ... 75 %          | 10 ... 75 %          |

# General technical data

## K/C6, 4 pole

### Terminal & mounting characteristics

#### Mounting characteristics and conditions for use

|                    |   |                                 |
|--------------------|---|---------------------------------|
| Contactor types    | AC operated<br>DC operated                                      | K6<br>KC6                       |
| Mounting positions |   |                                 |
| Mounting distances | The contactors can be assembled side by side.                   |                                 |
| Fixing             | On rail acc. to IEC 60715, EN 60715<br>By screws (not supplied) |                                 |
|                    | 35 x 7.5 mm or 35 x 15 mm                                       | 2 x M4 screws placed diagonally |

#### Connecting characteristics

|   |  |                           |
|---|--|---------------------------|
| Contactor relay types   | AC operated<br>DC operated   | K6<br>KC6, TKC6           |
| Main terminals <sup>1)</sup>  | <br>Screw terminals with cable clamp                                       |                           |
| Connection capacity   |  |                           |
| Main conductors (poles)   |  |                           |
| Rigid: solid  | 1 or 2 x   | 1 ... 4 mm <sup>2</sup>   |
| Flexible without ferrule  | 1 or 2 x   | 1 ... 2.5 mm <sup>2</sup> |
| Connection capacity acc. to UL/CSA  | 1 or 2 x   | AWG 22 ... 10             |
| Stripping length  |  | 9 mm                      |
| Tightening torques  |  | 0.8 ... 1.1 Nm / 7 lb.in  |
| Degree of protection<br>acc. to IEC 60947-1 / EN 60947-1 and IEC 60529 / EN 60529 |  |                           |
| All   | IP20   |                           |
| Screw terminals   | (Delivered in open position, screws of unused terminals must be tightened) |                           |
| All terminals   | M3   |                           |
| Screwdriver type  | Flat Ø 5.5 / Pozidriv 1  |                           |

<sup>1)</sup> Soldering pin connection acc. to DIN 40801: 0.8 x 1 mm / 0.8 x 2.54 mm

Flat pin connection acc. to DIN 46248: 1 x 6.3 mm / 1 x 2.8 mm







## General information

### Electronic timers

### Overview



#### CT-D range

#### CT-E range

#### CT-S range

6

#### Timing function

|  |   | multifunctional | single-functional | multifunctional | single-functional      | multifunctional                        | single-functional              |
|--|---|-----------------|-------------------|-----------------|------------------------|--|--------------------------------|
|  | ON-delay                                | CT-MFD          | CT-ERD            | CT-MFE, CT-MKE  | CT-ERE, CT-EKE         | CT-MVS, CT-MFS, CT-MBS, CT-WBS         | CT-ERS                         |
|  | OFF-delay                               | CT-MFD          | CT-AHD            | CT-MFE          | CT-AHE, CT-ARE, CT-AKE | CT-MVS, CT-MFS, CT-MBS                 | CT-APS, CT-AHS, CT-ARS, CT-VBS |
|  | ON- and OFF-delay                       |                 |                   |                 |                        | CT-MVS, CT-MXS, CT-MFS, CT-MBS         |                                |
|  | Impulse-ON                              | CT-MFD          | CT-VWD            | CT-MFE, CT-MKE  | CT-VWE                 | CT-MVS, CT-MFS, CT-MBS, CT-WBS         |                                |
|  | Impulse-OFF                             | CT-MFD          |                   |                 | CT-AWE                 | CT-MVS, CT-MFS, CT-MBS                 |                                |
|  | Impulse-ON and OFF                      |                 |                   |                 |                        | CT-MXS                                 |                                |
|  | Flasher starting with ON                | CT-MFD          | CT-EBD            | CT-MFE, CT-MKE  |                        | CT-MFS, CT-MBS, CT-WBS                 |                                |
|  | Flasher starting with OFF               | CT-MFD          |                   | CT-MFE, CT-MKE  | CT-EBE                 | CT-MFS, CT-MBS, CT-WBS                 |                                |
|  | Flasher starting with ON or OFF         |                 |                   |                 |                        | CT-MVS                                 |                                |
|  | Pulse generator starting with ON or OFF |                 | CT-TGD            |                 |                        | CT-MXS                                 |                                |
|  | Pulse former                            | CT-MFD          |                   | CT-MFE          |                        | CT-MVS, CT-MFS, CT-MBS                 |                                |
|  | Star-delta change-over                  |                 | CT-SDD, CT-SAD    |                 |                        |  | CT-SDS                         |
|  | Star-delta change-over with impulse     |                 |                   |                 | CT-SDE                 | CT-MVS.2x, CT-MFS, CT-MBS              |                                |
|  | Star-delta change-over twice ON-delayed |                 |                   |                 | CT-YDE                 |  |                                |
|  | further functions (depending on device) |                 |                   |                 |                        | CT-MVS, CT-MXS, CT-MFS, CT-MBS, CT-WBS |                                |
|  | Switching relay                         |                 |                   |                 | CT-IRE                 |  | CT-IRS                         |

#### Technical data (extract)

|                             |   |  |  |
|-----------------------------|---|--|--|
| Time ranges                 | 7 (0.05 s - 100 h)<br>CT-SDD, CT-SAD: 4 (0.05 s - 10 min)                   | Multifunction devices: 8 (0.05 s - 100 h)<br>Single-function devices: 5 single ranges (0.05-1 s, 0.1-10 s, 0.3-30 s, 3-300 s, 0.3-300 min) | 10 (0.05 s - 300 h)<br>CT-ARS, CT-SDS: 7 (0.05 s - 10 min)   |
| Control supply voltage      | Wide and multi ranges   | Wide ranges      Single and dual ranges  | Wide, multi and single ranges  |
| Type and number of contacts | 1 or 2 c/o contacts<br>CT-SDD, CT-SAD: 2 n/o contacts                       | 1 c/ o contact<br>CT-SDE: 1 n/o contact and 1 n/c contacts<br>CT-MKE, CT-EKE, CT-AKE: 1 thyristor  | 1 or 2 c/o contacts<br>CT-MVS.21, CT-MFS, CT-MBS: 2nd c/o contact selectable as inst. contact<br>CT-SDS: 2 n/o contacts            |
| Control inputs              | voltage-related triggering, polarized, capable of switching a parallel load | voltage-related triggering, polarized<br>CT-MFE, CT-AHE, CT-AWE:<br>with auxiliary voltage   | voltage-related triggering, non-polarized, capable of switching a parallel load<br>CT-MFS, CT-MBS, CT-AHS:<br>volt-free triggering |

# General information

## Electronic timers

### Approvals and marks

■ existing  
□ pending

|           |                             | CT-D      |           |           |           |           |           |           |           |           |           |           |           |  |  |  |  |  |  |
|-----------|-----------------------------|-----------|-----------|-----------|-----------|-----------|-----------|-----------|-----------|-----------|-----------|-----------|-----------|--|--|--|--|--|--|
| Approvals |                             | CT-MFD.12 | CT-MFD.21 | CT-ERD.12 | CT-ERD.22 | CT-AHD.12 | CT-AHD.22 | CT-VWD.12 | CT-EBD.12 | CT-TGD.12 | CT-TGD.22 | CT-SDD.22 | CT-SAD.22 |  |  |  |  |  |  |
|           | UL 508, CAN/CSA C22.2 No.14 | ■         | ■         | ■         | ■         | ■         | ■         | ■         | ■         | ■         | ■         | ■         | ■         |  |  |  |  |  |  |
|           | GOST                        | ■         | ■         | ■         | ■         | ■         | ■         | ■         | ■         | ■         | ■         | ■         | ■         |  |  |  |  |  |  |
|           | CB scheme                   | ■         | ■         | ■         | ■         | ■         | ■         | ■         | ■         | ■         | ■         | ■         | ■         |  |  |  |  |  |  |
|           | CCC                         | ■         | ■         | ■         | ■         | ■         | ■         | ■         | ■         | ■         | ■         | ■         | ■         |  |  |  |  |  |  |
| Marks     |                             |           |           |           |           |           |           |           |           |           |           |           |           |  |  |  |  |  |  |
|           | CE                          | ■         | ■         | ■         | ■         | ■         | ■         | ■         | ■         | ■         | ■         | ■         | ■         |  |  |  |  |  |  |
|           | C-Tick                      | ■         | □         | ■         | □         | ■         | □         | ■         | ■         | ■         | □         | □         | □         |  |  |  |  |  |  |

■ existing  
□ pending

|           |                             | CT-E   |        |        |        |        |        |        |        |        |        |  |        |        |        |  |  |  |  |
|-----------|-----------------------------|--------|--------|--------|--------|--------|--------|--------|--------|--------|--------|--|--------|--------|--------|--|--|--|--|
| Approvals |                             | CT-MFE | CT-ERE | CT-AHE | CT-ARE | CT-WWE | CT-AWE | CT-EBE | CT-YDE | CT-SDE | CT-IRE |  | CT-MKE | CT-EKE | CT-AKE |  |  |  |  |
|           | UL 508, CAN/CSA C22.2 No.14 | ■      | ■      | ■      | ■      | ■      | ■      | ■      | ■      | ■      | ■      |  | ■      | ■      | ■      |  |  |  |  |
|           | GL                          | ■      | ■      | ■      | ■      | ■      | ■      | ■      | ■      | ■      | ■      |  | ■      | ■      | ■      |  |  |  |  |
|           | GOST                        | ■      | ■      | ■      | ■      | ■      | ■      | ■      | ■      | ■      | ■      |  | ■      | ■      | ■      |  |  |  |  |
|           | CB scheme                   | ■      | ■      | ■      | ■      | ■      | ■      | ■      | ■      | ■      | ■      |  |        |        |        |  |  |  |  |
|           | CCC                         | ■      | ■      | ■      | ■      | ■      | ■      | ■      | ■      | ■      | ■      |  |        |        |        |  |  |  |  |
|           | RMRS                        | ■      | ■      | ■      | ■      | ■      | ■      | ■      | ■      | ■      | ■      |  | ■      | ■      | ■      |  |  |  |  |
| Marks     |                             |        |        |        |        |        |        |        |        |        |        |  |        |        |        |  |  |  |  |
|           | CE                          | ■      | ■      | ■      | ■      | ■      | ■      | ■      | ■      | ■      | ■      |  | ■      | ■      | ■      |  |  |  |  |
|           | C-Tick                      | ■      | ■      | ■      | ■      | ■      | ■      | ■      | ■      | ■      | ■      |  | ■      | ■      | ■      |  |  |  |  |

■ existing  
□ pending

|           |                             | CT-S      |           |           |           |           |           |           |           |           |           |           |           |           |           |           |  |           |           |           |
|-----------|-----------------------------|-----------|-----------|-----------|-----------|-----------|-----------|-----------|-----------|-----------|-----------|-----------|-----------|-----------|-----------|-----------|--|-----------|-----------|-----------|
| Approvals |                             | CT-MVS.12 | CT-MVS.2x | CT-MXS.22 | CT-MFS.21 | CT-MBS.22 | CT-WBS.22 | CT-EFS.12 | CT-EFS.2x | CT-APS.12 | CT-APS.2x | CT-AHS.22 | CT-ARS.11 | CT-ARS.21 | CT-VBS.1x | CT-SDS.2x |  | CT-IRS.1x | CT-IRS.2x | CT-IRS.3x |
|           | UL 508, CAN/CSA C22.2 No.14 | ■         | ■         | ■         | ■         | ■         | ■         | ■         | ■         | ■         | ■         | ■         | ■         | ■         | ■         | ■         |  |           |           |           |
|           | GL                          | ■         | ■         | ■         | ■         | ■         | ■         | ■         | ■         | ■         | ■         | ■         | □         | □         |           | ■         |  |           |           |           |
|           | GOST                        | ■         | ■         | ■         | ■         | ■         | ■         | ■         | ■         | ■         | ■         | ■         | ■         | ■         | ■         | ■         |  | ■         | ■         | ■         |
|           | CB scheme                   | ■         | ■         | ■         | ■         | ■         | ■         | ■         | ■         | ■         | ■         | ■         | ■         | ■         | ■         | ■         |  | ■         | ■         | ■         |
|           | CCC                         | ■         | ■         | ■         | ■         | ■         | ■         | ■         | ■         | ■         | ■         | ■         | ■         | ■         | ■         | ■         |  | ■         | ■         | ■         |
| Marks     |                             |           |           |           |           |           |           |           |           |           |           |           |           |           |           |           |  |           |           |           |
|           | CE                          | ■         | ■         | ■         | ■         | ■         | ■         | ■         | ■         | ■         | ■         | ■         | ■         | ■         | ■         | ■         |  | ■         | ■         | ■         |
|           | C-Tick                      | ■         | ■         | ■         | ■         | ■         | ■         | ■         | ■         | ■         | ■         | ■         | ■         | ■         | ■         | ■         |  | ■         | ■         | ■         |





CT-D Range

# CT-D Range Electronic timers



# CT-D Range Benefits and advantages

## Characteristics

- Diversity:
  - 2 multifunction timers
  - 10 single-function timers
- Control supply voltages:
  - Wide range: 12-240 V AC/DC
  - Multi range: 24-48 V DC, 24-240 V AC
- 7 time ranges from 0.05s to 100 h or 4 time ranges from 0.05 s - 10 min
- Width of only 17.5 mm
- Light-grey housing in RAL 7035
- Devices with:
  - 1 c/o contact (250 V / 6 A) or 2 c/o contacts (250 V / 5 A)
  - Control input: voltage-related triggering, polarized, capable of switching a parallel load
- Approvals / Marks (partly depending)



6

## Benefits

### Direct reading scales ①

Direct setting of the time delay without any additional calculation provides accurate time delay adjustment.

### LEDs for status indication ②

All actual operational states are displayed by front-face LEDs, thus simplifying commissioning and troubleshooting.

### Switching currents

The CT-D range timers allow an output load of up to 6 A on devices with 1 c/o contact and up to 5 A on devices with 2 c/o contacts.

### Connection terminals ③

Wide terminal spacing allows connection of wires: 2 x 1.5 mm<sup>2</sup> (2 x 16 AWG) with wire end ferrules or - 2 x 2.5 mm<sup>2</sup> (2 x 14 AWG) without ferrules.

### Width 17,5 mm ④

With their width of 17.5 mm only, the CT-D range timers are ideally suited for installation in distribution panels.

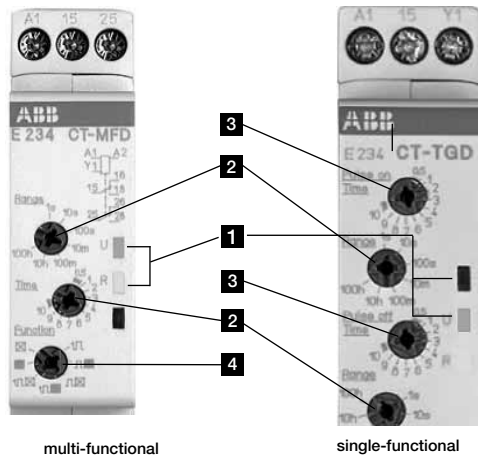

## Operating controls

### 1 LEDs for status indication

U - green LED:

— control supply voltage applied

▭ timing

R, R1, R2 - yellow LED:

▭ output relay energized

### 2 Time range adjustment

### 3 Fine adjustment of the time delay

### 4 Timing range selector

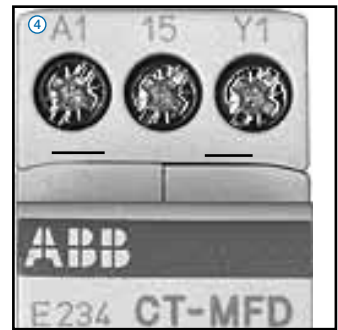
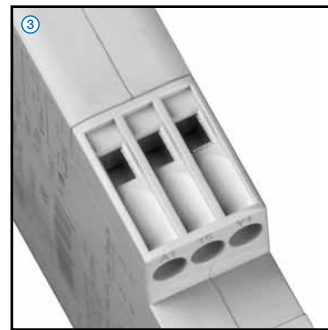
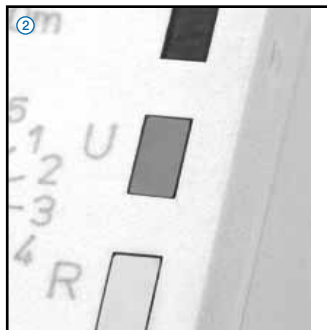
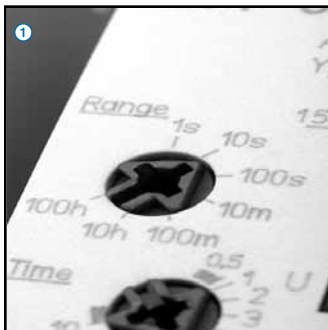

## CT-D Range Ordering details

### Description

The CT-D range with a width of only 17.5 mm fits into all domestic installation and distribution panels.

For maximum flexibility in operation, 10 single-function as well as 2 multifunction devices with 7 timing functions are available. The devices offer 4 or 7 time ranges from 0.05 seconds up to 100 hours. Their wide input range allows the use in applications worldwide.



CT-MFD.12



CT-ERD.22

- ON-delay
- OFF-delay
- Impulse-ON
- Impulse-OFF
- Flasher starting with ON
- Flasher starting with OFF
- Pulse former
- Pulse generator
- Star-delta change-over

### Ordering details

| Time function            | Rated control supply voltage | Time ranges         | Control input           | Output          | Reference code          | Catalog number   | Weight (1 pce)<br>kg (lb) |
|--------------------------|------------------------------|---------------------|-------------------------|-----------------|-------------------------|------------------|---------------------------|
| <br><br><br><br><br><br> | 24-240 V AC<br>24-48 V DC    | 7 (0.05 s - 100 h)  | ■                       | 1 c/o           | CT-MFD.12               | 1SVR500020R0000  | 0.060 (0.132)             |
| <br><br><br><br><br><br> | 12-240 V AC/<br>DC           | 7 (0.05 s - 100 h)  | ■                       | 2 c/o           | CT-MFD.21               | 1SVR500020R1100  | 0.065<br>(0.143)          |
|                          | 24-240 V AC<br>24-48 V DC    | 7 (0.05 s - 100 h)  |                         | 1 c/o           | CT-ERD.12               | 1SVR500100R0000  | 0.060 (0.132)             |
|                          |                              |                     | 2 c/o                   | CT-ERD.22       | 1SVR500100R0100         | 0.065<br>(0.143) |                           |
|                          |                              |                     | ■                       | 1 c/o           | CT-AHD.12               | 1SVR500110R0000  | 0.060 (0.132)             |
|                          |                              |                     | ■                       | 2 c/o           | CT-AHD.22               | 1SVR500110R0100  | 0.065<br>(0.143)          |
|                          |                              |                     | 1 c/o                   | CT-VWD.12       | 1SVR500130R0000         | 0.060 (0.132)    |                           |
|                          |                              |                     | 1 c/o                   | CT-EBD.12       | 1SVR500150R0000         | 0.060 (0.132)    |                           |
|                          |                              |                     | ■                       | 1 c/o           | CT-TGD.12 <sup>1)</sup> | 1SVR500160R0000  | 0.060 (0.132)             |
|                          | ■                            | 1 c/o               | CT-TGD.22 <sup>1)</sup> | 1SVR500160R0100 | 0.065<br>(0.143)        |                  |                           |
|                          |                              | 4 (0.05 s - 10 min) |                         | 2 n/o           | CT-SDD.22 <sup>2)</sup> | 1SVR500211R0100  | 0.065<br>(0.143)          |
|                          |                              |                     |                         | 2 n/o           | CT-SAD.22 <sup>3)</sup> | 1SVR500210R0100  | 0.065<br>(0.143)          |

1) ON and OFF times adjustable independently: 2 x 7 time ranges 0.05 s - 100 h

2) Transition time 50 ms fixed

3) Transition time adjustable

### Synonyms

| used expression | alternative expression(s) | used expression | alternative expression(s) |
|-----------------|---------------------------|-----------------|---------------------------|
| 1 c/o contact   | SPDT                      | voltage-related | wet / non-floating        |
| 2 c/o contacts  | DPDT                      | volt-free       | dry / floating            |

# CT-D range Function diagrams

## Remarks

### Legend

- Control supply voltage not applied / Output contact open
- Control supply voltage applied / Output contact closed
- A1-Y1/B1 Control input with voltage-related triggering

### Terminal designations on the device and in the diagrams

- The 1st c/o contact is always designated **15-16/18**.
- The 2nd c/o contact is designated **25-26/28**.
- The n/o contacts of the star-delta timers are designated with **17-18** and **17-28**.
- Control supply voltage is always applied to terminals **A1-A2**.

### Function of the yellow LED

The yellow LED **R** glows as soon as the output relay energizes and turns off when the output relay de-energizes.

6

#### ☒ ON-delay (Delay on make) CT-ERD, CT-MFD

This function requires continuous control supply voltage for timing. Timing begins when control supply voltage is applied. The green LED flashes during timing. When the selected time delay is complete, the output relay energizes and the flashing green LED turns steady. If control supply voltage is interrupted, the output relay de-energizes and the time delay is reset. Control input **A1-Y1/B1** of the CT-MFD is disabled when this function is selected.

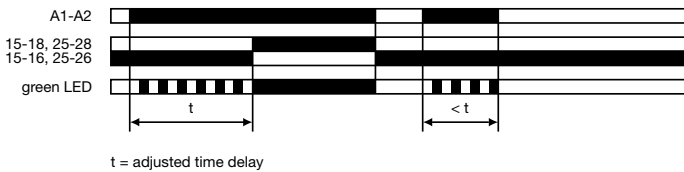

#### ■ OFF-delay with auxiliary voltage (Delay on break) CT-AHD, CT-MFD

This function requires continuous control supply voltage for timing. If control input A1-Y1/B1 is closed, the output relay energizes immediately. If control input A1-Y1/B1 is opened, the time delay starts. The green LED flashes during timing. When the selected time delay is complete, the output relay de-energizes and the flashing green LED turns steady. If control input **A1-Y1/B1** recloses before the time delay is complete, the time delay is reset and the output relay does not change state. Timing starts again when control input **A1-Y1/B1** re-opens. If control supply voltage is interrupted, the output relay de-energizes and the time delay is reset.

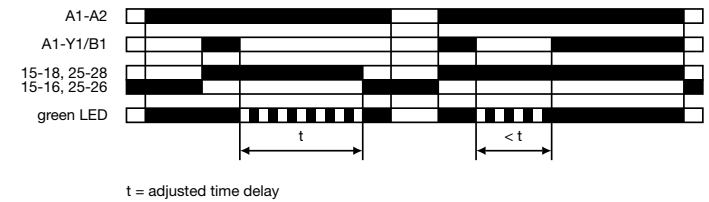

#### 1┐☒ Impulse-ON (Interval) CT-VWD, CT-MFD

This function requires continuous control supply voltage for timing. The output relay energizes immediately when control supply voltage is applied and de-energizes after the set pulse time is complete. The green LED flashes during timing. When the selected pulse time is complete, the flashing green LED turns steady. If control supply voltage is interrupted, the output relay de-energizes and the time delay is reset. Control input A1-Y1/B1 of the CT-MFD is disabled when this function is selected.

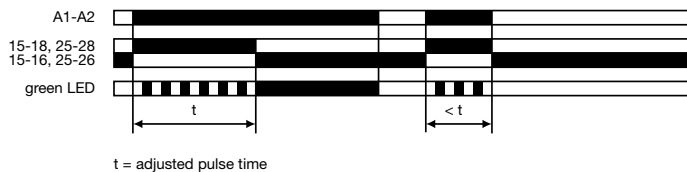

#### 1┐■ Impulse-OFF with auxiliary voltage (Trailing edge interval) CT-MFD

This function requires continuous control supply voltage for timing. If control supply voltage is applied, opening control input A1-Y1/B1 energizes the output relay immediately and starts timing. The green LED flashes during timing. When the selected pulse time is complete, the output relay de-energizes and the flashing green LED turns steady. Closing control input A1-Y1/B1, before the time delay is complete, de-energizes the output relay and resets the time delay. If control supply voltage is interrupted, the output relay de-energizes and the time delay is reset.

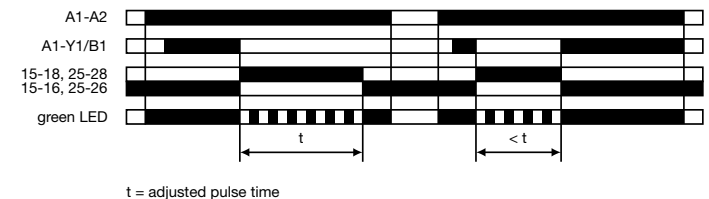





# CT-D range Function diagrams

 **Flasher, starting with the ON time  
(Recycling equal times, ON first)**  
CT-EBD, CT-MFD

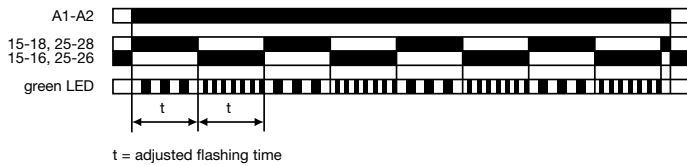
Applying control supply voltage starts timing with symmetrical ON & OFF times. The cycle starts with an ON time first. The ON & OFF times are displayed by the flashing green LED, which flashes twice as fast during the OFF time. If control supply voltage is interrupted, the output relay de-energizes and the time delay is reset. Control input **A1-Y1/B1** of the CT-MFD is disabled when this function is selected.



 **Flasher, starting with the OFF time  
(Recycling equal times, OFF first)**  
CT-MFD

Applying control supply voltage starts timing with symmetrical ON & OFF times. The cycle starts with an OFF time first. The ON & OFF times are displayed by the flashing green LED, which flashes twice as fast during the OFF time. If control supply voltage is interrupted, the output relay de-energizes and the time delay is reset. Control input **A1-Y1/B1** of the CT-MFD is disabled when this function is selected.

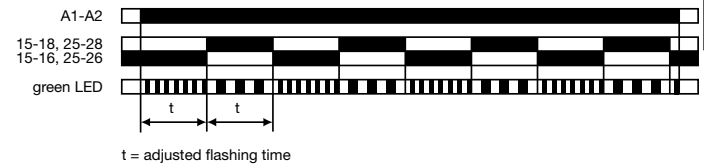

6

 **Pulse former (Single shot)**  
CT-MFD

This function requires continuous control supply voltage for timing. Closing control input **A1-Y1/B1** energizes the output relay immediately and starts timing. Operating the control contact switch **A1-Y1/B1** during the time delay has no effect. The green LED flashes during timing. When the selected ON time is complete, the output relay de-energizes and the flashing green LED turns steady. After the ON time is complete, it can be restarted by closing control input **A1-Y1/B1**. If control supply voltage is interrupted, the output relay de-energizes and the time delay is reset.

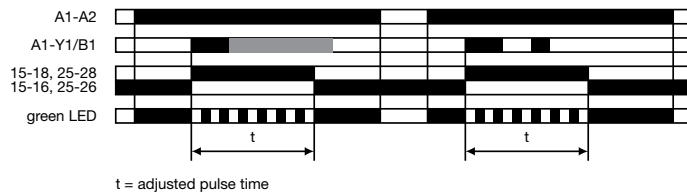

 **Pulse generator, starting with the ON or OFF time  
(Recycling unequal times, ON or OFF first)**  
CT-TGD

This function requires continuous control supply voltage for timing. Applying control supply voltage, with open control input **A1-Y1/B1**, starts timing with an ON time first. Applying control supply voltage, with closed control input **A1-Y1/B1**, starts timing with an OFF time first. The ON & OFF times are displayed by the flashing green LED, which flashes twice as fast during the OFF time. The ON & OFF times are independently adjustable. If control supply voltage is interrupted, the output relay de-energizes and the time delay is reset.

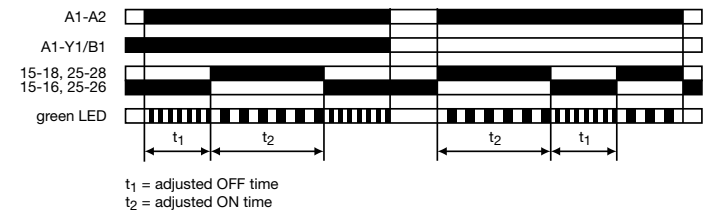

# CT-D range Function diagrams

△ **Star-delta change-over  
(Star-delta starting)**  
CT-SDD, CT-SAD

This function requires continuous control supply voltage for timing. Applying control supply voltage to terminals **A1-A2**, energizes the star contactor connected to terminals **17-18** and begins the set starting time  $t_1$ . The green LED flashes during timing. When the starting time is complete, the first output contact de-energizes the star contactor.

Now, the transition time  $t_2$  starts. When the transition time is complete, the second output contact energizes the delta contactor connected to terminals **17-28**. The delta contactor remains energized as long as control supply voltage is applied to the unit.

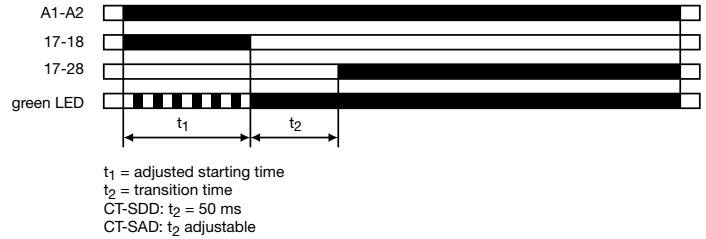

6

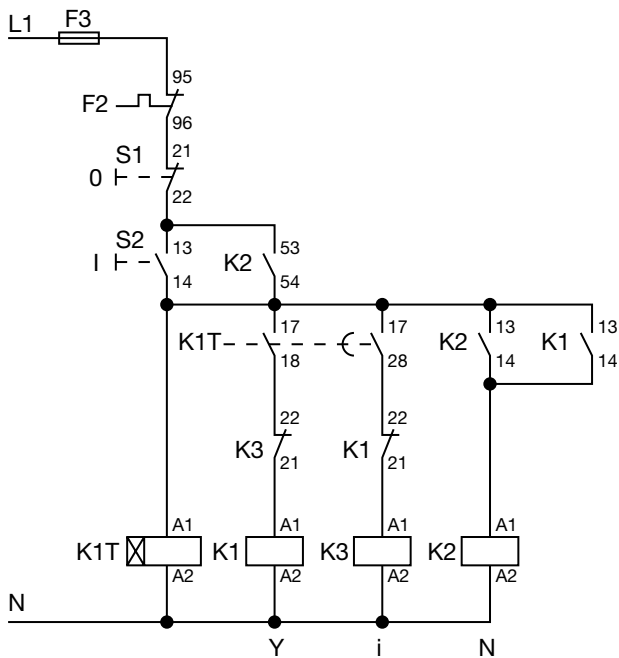

Control circuit diagram

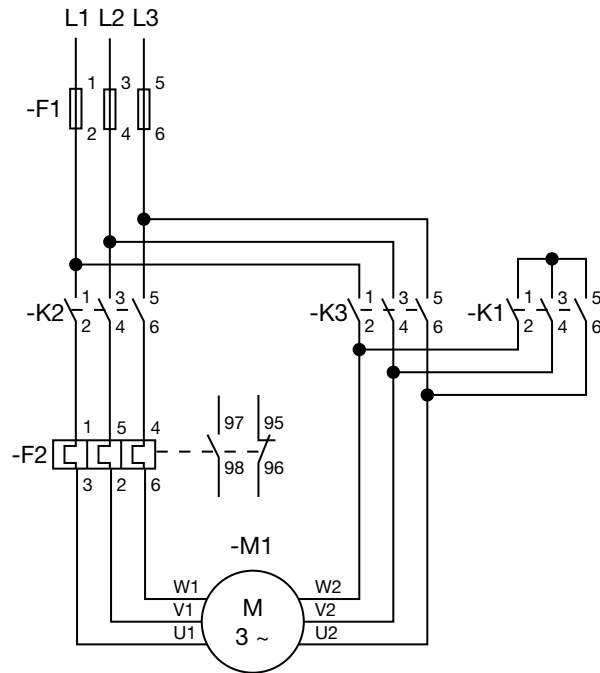

Power circuit diagram

# CT-D range Connection diagrams

**CT-MFD.21**

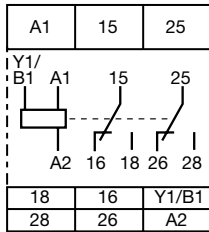

A1-A2 Supply: 12-240 V AC/DC

15-16/18 1. c/o contact  
25-26/28 2. c/o contact  
A1-Y1/B1 Control input

**CT-MFD.12**

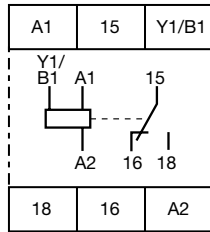

A1-A2 Supply: 24-48 V DC or 24-240 V AC

15-16/18 1. c/o contact  
A1-Y1/B1 Control input

**CT-ERD.22**

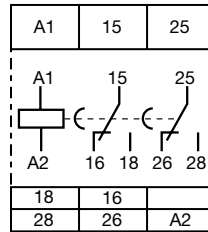

A1-A2 Supply: 24-48 V DC or 24-240 V AC

15-16/18 1. c/o contact  
25-26/28 2. c/o contact

**CT-ERD.12**

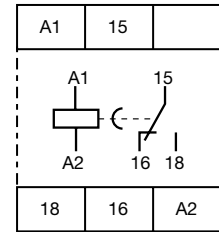

A1-A2 Supply: 24-48 V DC or 24-240 V AC

15-16/18 1. c/o contact

**CT-AHD.22**

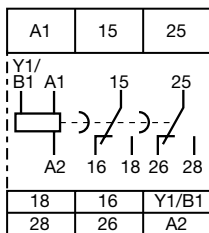

A1-A2 Supply: 24-48 V DC or 24-240 V AC

15-16/18 1. c/o contact  
25-26/28 2. c/o contact  
A1-Y1/B1 Control input

**CT-AHD.12**

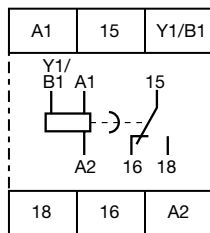

A1-A2 Supply: 24-48 V DC or 24-240 V AC

15-16/18 1. c/o contact  
A1-Y1/B1 Control input

**CT-VWD.12**

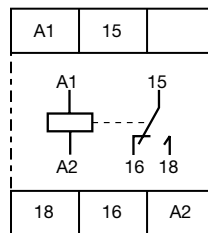

A1-A2 Supply: 24-48 V DC or 24-240 V AC

15-16/18 1. c/o contact

**CT-EBD.12**

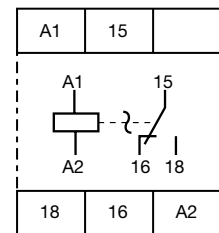

A1-A2 Supply: 24-48 V DC or 24-240 V AC

15-16/18 1. c/o contact

**CT-TGD.22**

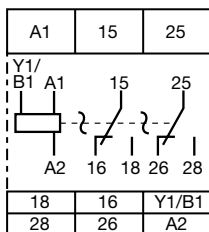

A1-A2 Supply: 24-48 V DC or 24-240 V AC

15-16/18 1. c/o contact  
25-26/28 2. c/o contact  
A1-Y1/B1 Control input

**CT-TGD.12**

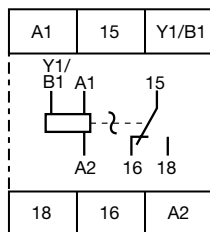

A1-A2 Supply: 24-48 V DC or 24-240 V AC

15-16/18 1. c/o contact  
A1-Y1/B1 Control input

**CT-SDD.22**

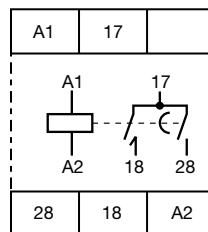

A1-A2 Supply: 24-48 V DC or 24-240 V AC

17-18 1. n/o contact (star contactor)  
17-28 2. n/o contact (delta contactor)

**CT-SAD.22**

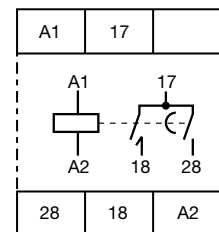



A1-A2 Supply: 24-48 V DC or 24-240 V AC

17-18 1. n/o contact (star contactor)  
17-28 2. n/o contact (delta contactor)

# CT-D range

## Technical data

Data at  $T_a = 25\text{ °C}$  and rated values, unless otherwise indicated

|   |  | CT-D with 1 c/o contact                              | CT-D with 2 c/o contacts  | CT-MFD.21  |
|---|--|--|---|--|
| <b>Input circuit - Supply circuit</b>                                   |  |  |   |  |
| Rated control supply voltage $U_S$                                      |  | 24-240 V AC / 24-48 V DC                             |   | 12-240 V AC/DC   |
| Rated control supply voltage $U_S$ tolerance                            |  |  |   | -15...+10 %  |
| Rated frequency   |  | AC/DC versions                                       | DC or 50/60 Hz  | 50/60 Hz   |
| Frequency range   |  | AC versions  | DC or 47-63 Hz  | see data sheet   |
| Typical current / power consumption                                     |  |  |   |  |
| Power failure buffering time  |  | min. 20 ms   | min. 30 ms  |  |
| <b>6 Input circuit - Control circuit</b>                                |  |  |   |  |
| Kind of triggering  |  | voltage-related triggering                           |   |  |
| Control input, Control function   |  | A1-Y1/B1   | start timing external   |  |
| Parallel load / polarized   |  | yes / yes  |   |  |
| Rated operational voltage $U_B$   |  | 250 V  |   |  |
| Minimum switching voltage / minimum switching current                   |  | 12 V / 100 mA  |   |  |
| Maximum switching voltage / maximum switching current                   |  | see load limit curves                                |   |  |
| Minimum control pulse length  |  | 30 ms  |   |  |
| Control voltage potential   |  | see rated control supply voltage                     |   |  |
| Current consumption of the control input                                |  | max. 4 mA  | see data sheet  |  |
| <b>Timing circuit</b>   |  |  |   |  |
| Time ranges   |  | 7 time ranges 0.05 s - 100 h                         |   |  |
|   |  | 1.) 0.05-1 s 2.) 0.5-10 s 3.) 5-100 s 4.) 0.5-10 min |   |  |
|   |  | 5.) 5-100 min 6.) 0.5-10 h 7.) 5-100 h               |   |  |
|   |  | 4 time ranges 0.05 s - 10 min (CT-SDD, CT-SAD)       |   |  |
|   |  | 1.) 0.05-1 s 2.) 0.5-10 s 3.) 5-100 s 4.) 0.5-10 min |   |  |
| Recovery time   |  | < 50 ms  |   |  |
| Accuracy within the rated control supply voltage tolerance              |  | $\Delta t < 0.005\% / V$                             |   |  |
| Accuracy within the temperature range                                   |  | $\Delta t < 0.06\% / \text{°C}$                      |   |  |
| Repeat accuracy (constant parameters)                                   |  | $\Delta t \pm 0.5\%$                                 |   |  |
| Star-delta transition time  |  | CT-SDD / CT-SAD                                      | fixed 50 ms / adjustable: 20-100 ms in steps of 10 ms   |  |
| Star-delta transition time tolerance                                    |  | CT-SDD / CT-SAD                                      | $\pm 3\text{ ms}$   |  |
| <b>Indication of operational states</b>                                 |  |  |   |  |
| Control supply voltage / timing   |  | U: green LED   |  : control supply voltage applied<br> : timing |  |
| Relay status  |  | R: yellow LED  |  : output relay energized   |  |
| <b>Output circuit</b>   |  |  |   |  |
| Kind of output  |  | 15-16/18<br>15-16/18; 25-26/28<br>17-18; 17-28       | Relay, 1 c/o contact  | -<br>Relay, 2 c/o contacts<br>relay, 2 n/o contacts (CT-SDD, CT-SAD) |
| Contact material  |  | Cd-free, see data sheet                              |   |  |
| Rated operational voltage $U_B$   |  | 250 V  |   |  |
| Minimum switching voltage / minimum switching current                   |  | 12 V / 100 mA  |   |  |
| Maximum switching voltage / maximum switching current                   |  | see load limit curves                                |   |  |
| Rated operational current $I_B$ (IEC/EN 60947-5-1)                      |  | AC12 (resistive) at 230 V                            | 6 A   | 5 A  |
|   |  | AC15 (inductive) at 230 V                            | 3 A   | 3 A  |
|   |  | AC15 (inductive) at 230 V                            | 6 A   | 5 A  |
|   |  | DC13 (inductive) at 24 V                             | 2 A   | 2 A <sup>1)</sup>  |
|   |  | Utilization category (Rating Code)                   | B 300   |  |
| AC rating (UL 508)  |  | max. rated operational voltage                       | 300 V AC  |  |
|   |  | Maximum continuous thermal current at B300           | 5 A   |  |
|   |  | max. making/breaking apparent power at B300          | 3600 VA / 360 VA  |  |
| Mechanical lifetime   |  | 30 x 10 <sup>6</sup> switching cycles                |   |  |
| Electrical lifetime   |  | 0.1 x 10 <sup>6</sup> switching cycles               |   |  |
| Max. fuse rating to achieve short-circuit protection (IEC/EN 60947-5-1) |  | n/c contact  | 6 A fast-acting   |  |
|   |  | n/o contact  | 10 A fast-acting  |  |

# CT-D range

## Technical data

|  | CT-D with 1 c/o contact                      | CT-D with 2 c/o contacts                                | CT-MFD.21 |
|--|--|---|-----------|
| <b>General data</b>  |  |   |           |
| Duty time  |  | 100%  |           |
| Dimensions (W x H x D)   | 17.5 x 70 x 58 mm<br>(0.69 x 2.76 x 2.28 in) | 17.5 x 80 x 58 mm<br>(0.69 x 3.15 x 2.28 in)            |           |
| Weight   |  | see ordering details                                    |           |
| Mounting   |  | DIN rail (IEC/EN 60715), snap-mounting without any tool |           |
| Mounting position  |  | any   |           |
| Minimum distance to other units  | horizontal / vertical                        | no / no   |           |
| Degree of protection   | housing / terminals                          | IP50 / IP20   |           |
| <b>Electrical connection</b>   |  |   |           |
| Wire size  | fine-strand with(out) wire end ferrule       | 2 x 0.5-1.5 mm <sup>2</sup> (2 x 20-16 AWG)             |           |
|  |  | 1 x 0.5-2.5 mm <sup>2</sup> (1 x 20-14 AWG)             |           |
|  | rigid  | 2 x 0.5-1.5 mm <sup>2</sup> (2 x 20-16 AWG)             |           |
|  |  | 1 x 0.5-4 mm <sup>2</sup> (1 x 20-12 AWG)               |           |
| Stripping length   |  | 7 mm (0.28 in)  |           |
| Tightening torque  |  | 0.5-0.8 Nm  |           |
| <b>Environmental data</b>  |  |   |           |
| Ambient temperature range  | operation / storage                          | -20 ... +60 °C / -40 ... +85 °C                         |           |
| Damp heat (cyclic)   | IEC/EN 60068-2-30                            | 6 x 24 h cycles, 55 °C, 95 % RH                         |           |
| Vibration (sinusoidal)   | IEC/EN 60068-2-6                             | 40 m/s <sup>2</sup> , 20 cycles, 10...150...10 Hz       |           |
| Shock (half-sine)  | IEC/EN 60068-2-27                            | 100 m/s <sup>2</sup> , 11 ms                            |           |
| <b>Isolation data</b>  |  |   |           |
| Rated impulse withstand voltage U <sub>imp</sub> between all isolated circuits | VDE 0110, IEC/EN 60664-1                     | 4 kV; 1.2/50 µs   |           |
| Pollution category   | IEC/EN 60664-1, VDE 0110                     | 3   |           |
| Overvoltage category   | IEC/EN 60664-1, VDE 0110                     | III   |           |
| Rated insulation voltage U <sub>i</sub>  | input circuit / output circuit               | 300 V   |           |
|  | output circuit 1 / output circuit 2          | 300 V   |           |
| Basic insulation (IEC/EN 61140)  | input circuit / output circuit               | 300 V   |           |
| Protective separation (VDE 0106 part 101 and part 101/A1; IEC/EN 61140)        | input circuit / output circuit               | 250 V   |           |
| Power-frequency withstand voltage test (test voltage, routine test)            | between all isolated circuits                | 2.5 kV, 50 Hz, 1 s                                      |           |
| <b>Standards</b>   |  |   |           |
| Product standard   |  | IEC 61812-1, EN 61812-1 + A11, DIN VDE 0435 part 2021   |           |
| Low Voltage Directive  |  | 2006/95/EC  |           |
| EMC Directive  |  | 2004/108/EC   |           |
| RoHS Directive   |  | 2002/95/EC  |           |
| <b>Electromagnetic compatibility</b>   |  |   |           |
| Interference immunity to   |  | IEC/EN 61000-6-1, IEC/EN 61000-6-2                      |           |
| electronic discharge   | IEC/EN 61000-4-2                             | Level 3 (6 kV / 8 kV)                                   |           |
| radiated, radio-frequency, electromagnetic field                               | IEC/EN 61000-4-3                             | Level 3 (10 V / m)                                      |           |
| electrical fast transient/burst  | IEC/EN 61000-4-4                             | Level 3 (2 kV / 5 kHz)                                  |           |
| surge  | IEC/EN 61000-4-5                             | Level 4   |           |
| conducted disturbances, induced by radio-frequency fields                      | IEC/EN 61000-4-6                             | Level 3 (10 V)  |           |
| Interference emissions   |  | IEC/EN 61000-6-3, IEC/EN 61000-6-4                      |           |
| high-frequency radiated  | IEC/CISPR 22, EN 55022                       | Class B   |           |
| high-frequency conducted   | IEC/CISPR 22, EN 55022                       | Class   |           |

# CT-D range

## Technical data, Technical diagrams

### Technical diagrams

#### Load limit curves

AC load (resistive)

6

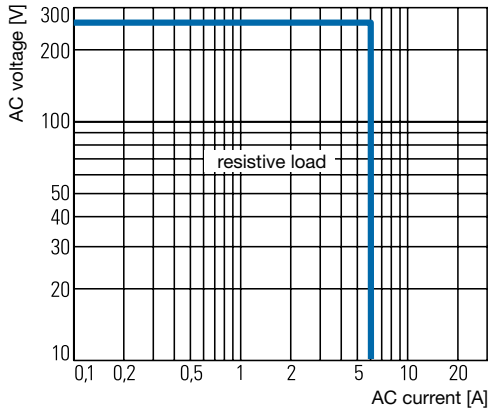

CT-D.1x

DC load (resistive)

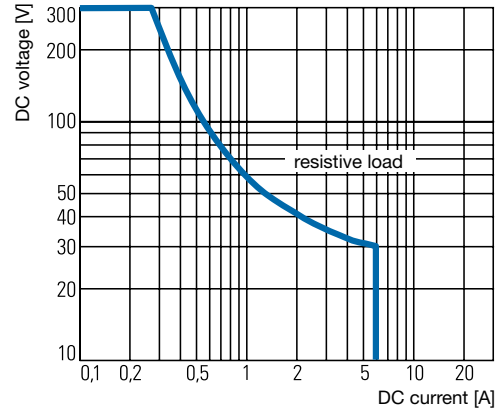

CT-D.1x

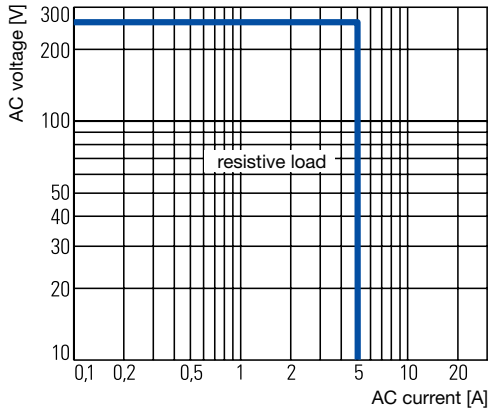

CT-D.2x

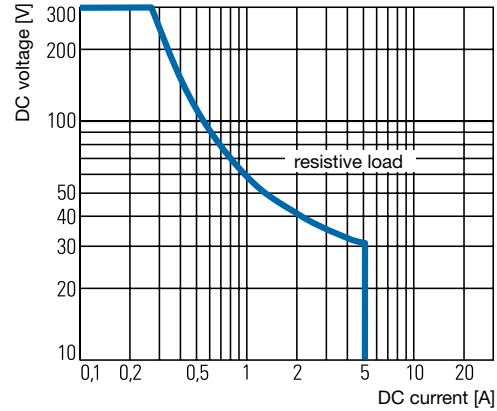

CT-D.2x

#### Derating factor F for inductive AC load

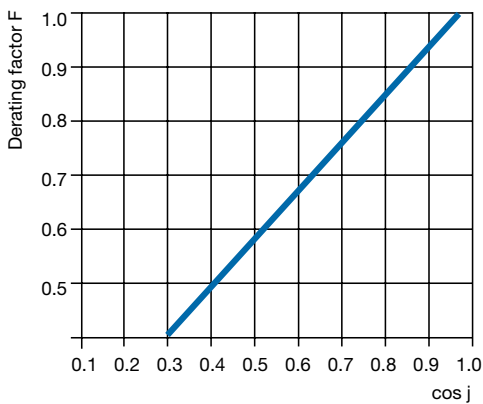

#### Contact lifetime

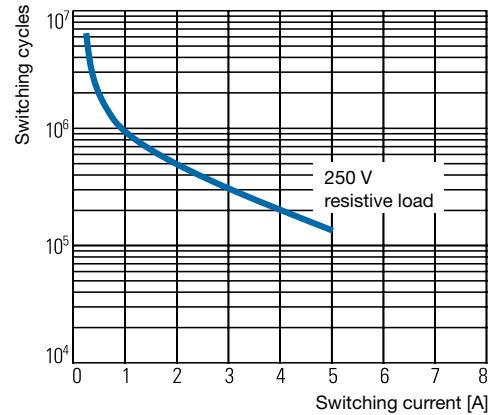

# CT-D range

## Approximate dimensions

### Wiring notes for devices with control input

A parallel load to the control input is possible

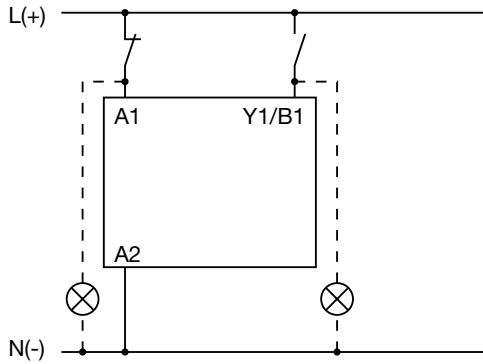

### Dimensional drawings

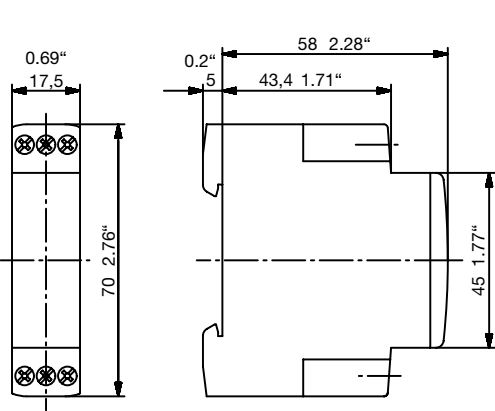

CT-D devices with 1 c/o contact or 2 n/o contacts

dimensions in mm

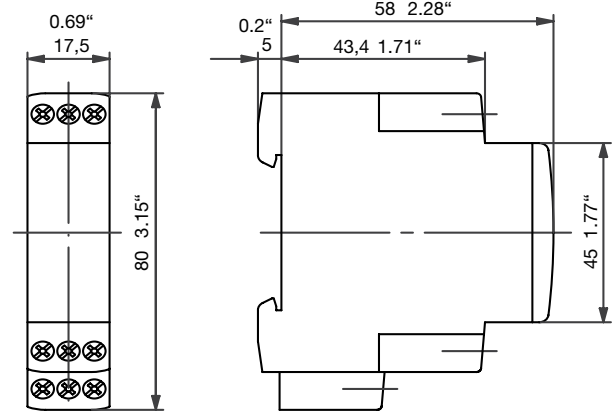

CT-D devices with 2 c/o contacts

## Notes



# CT-E Range Electronic Timers



# CT-E range

## Benefits and advantages

### Characteristics

- Diversity:
  - 2 multifunction timers
  - 56 single-function timers
  - 4 switching relays
- Control supply voltages:
  - Dual range: 24 V AC/DC
  - Single range: 110-130 V AC, 220-240 V AC
  - Wide range: 24-240 V AC/DC (CT-MFE)
- Time ranges
  - 5 single ranges: 0.05-1 s, 0.1-10 s, 0.3-30 s, 3-300 s, 0.3-30 min
  - 8 time ranges: 0.05 s - 100 h (CT-MFE)
- Devices with 1 c/o (SPDT) contact (250 V / 4 A) or solid-state output for high switching frequencies (thyristor 0.8 A)
- Switching relay CT-IRE for added switching contacts with either side-by-side or diagonally positioned connection terminals

6

### Benefits

#### Direct reading scales ①

Direct setting of the time delay without any additional calculation provides accurate time delay adjustment.

#### LEDs for status indication ②

All actual operational states are displayed by front-face LEDs, thus simplifying commissioning and troubleshooting.

#### Connection screws in M3 (Pozidrive 1) ③

Easy and fast tightening and release of the connection screws with pozidrive, pan- or crosshead screwdriver.

#### Solid-state output ④

Devices with solid-state output are the perfect solution for high operation cycles.

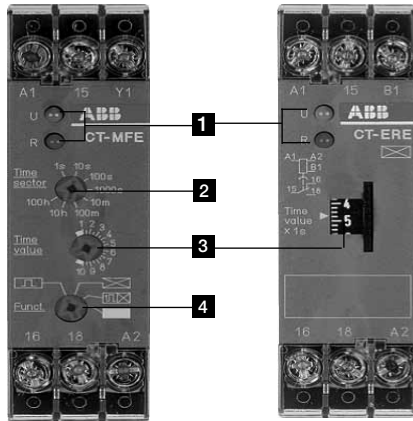

### Operating controls

- LEDs for status indication
  - U - green LED: control supply voltage applied
  - R2: red LED: output relay energized
- Time range adjustment (only multifunctional devices)
- Fine adjustment of the time delay
- Preselection of the timing function (only multifunctional devices)

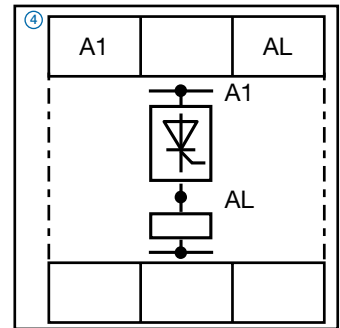
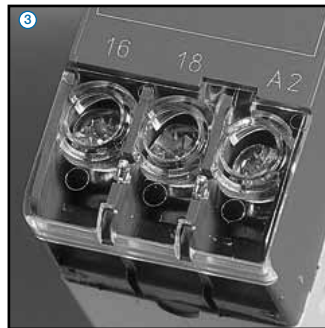
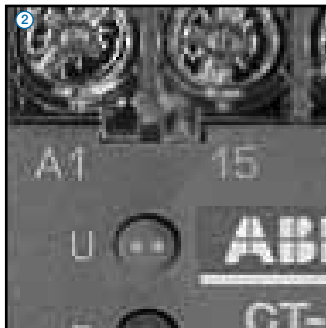
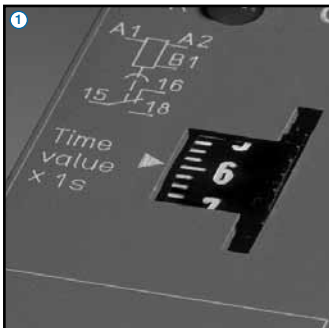

# CT-E range

## Ordering details



CT-MFE



CT-AHE

- ON-delay
- OFF-delay
- Impulse-ON
- Impulse-OFF
- Flasher starting with ON
- Flasher starting with OFF
- Pulse former

### Description

The CT-E range with its excellent price/performance ratio offers an ideal solution for serial applications. 56 single function devices with 5 different time ranges as well as 2 multifunction timers with 6 functions and 8 time ranges offer the highest possible flexibility for almost every application. For high operating cycles, contact-free CT-E timers with solid-state output are available.

### Ordering details

| Time function            | Rated control supply voltage | Time ranges           | Control Input | Output | Reference code       | Catalog number   | Weight (1 pce)<br>kg (lb) |
|--------------------------|------------------------------|-----------------------|---------------|--------|----------------------|------------------|---------------------------|
| <br><br><br><br><br><br> | 24-240 V AC/DC               | 8<br>(0.05 s - 100 h) | ■             | 1 c/o  | CT-MFE               | 1SVR550029R8100  | 0.08 (0.18)               |
|                          | 24 V AC/DC,<br>220-240 V AC  | 0.1-10 s              | ■             | 1 c/o  | CT-ERE               | 1SVR550107R1100  | 0.08 (0.18)               |
|                          |                              | 0.3-30 s              |               |        |                      | 1SVR550107R4100  |                           |
|                          |                              | 3-300 s               |               |        |                      | 1SVR550107R2100  |                           |
|                          | 0.3-30 min                   | 1SVR550107R5100       |               |        |                      |                  |                           |
|                          | 110-130 V AC                 | 0.1-10 s              |               |        |                      | 1SVR550100R1100  |                           |
|                          |                              | 0.3-30 s              |               |        |                      | 1SVR550100R4100  |                           |
| 3-300 s                  |                              | 1SVR550100R2100       |               |        |                      |                  |                           |
|                          | 24 V AC/DC                   | 0.1-10 s              | ■             | 1 c/o  | CT-AHE <sup>2)</sup> | 1SVR550118R1100  | 0.08 (0.18)               |
|                          |                              | 0.3-30 s              |               |        |                      | 1SVR550118R4100  |                           |
|                          |                              | 3-300 s               |               |        |                      | 1SVR550118R2100  |                           |
|                          | 110-130 V AC                 | 0.1-10 s              |               |        |                      | 1SVR550110R1100  |                           |
|                          |                              | 0.3-30 s              |               |        |                      | 1SVR550110R4100  |                           |
|                          |                              | 3-300 s               |               |        |                      | 1SVR550110R2100  |                           |
| 220-240 V AC             | 0.1-10 s                     | 1SVR550111R1100       |               |        |                      |                  |                           |
|                          | 0.3-30 s                     | 1SVR550111R4100       |               |        |                      |                  |                           |
|                          | 3-300 s                      | 1SVR550111R2100       |               |        |                      |                  |                           |
| <sup>1)</sup>            | 24 V AC/DC,<br>220-240 V AC  | 0.1-10 s              | ■             | 1 c/o  | CT-ARE               | 1SVR550127R1100  | 0.08 (0.18)               |
|                          |                              | 0.3-30 s              |               |        |                      | 1SVR550127R4100  |                           |
|                          | 110-130 V AC                 | 0.1-10 s              |               |        |                      | 1SVR550120R1100  |                           |
|                          |                              | 0.3-30 s              |               |        |                      | 1SVR550120R4100  |                           |
|                          | 24 V AC/DC,<br>220-240 V AC  | 0.1-10 s              | ■             | 1 c/o  | CT-VWE               | 1SVR550137R1100  | 0.08 (0.18)               |
|                          |                              | 0.3-30 s              |               |        |                      | 1SVR550137R4100  |                           |
|                          |                              | 3-300 s               |               |        |                      | 1SVR550137R2100  |                           |
|                          | 110-130 V AC                 | 0.1-10 s              |               |        |                      | 1SVR550130R1100  |                           |
|                          |                              | 0.3-30 s              |               |        |                      | 1SVR550130R4100  |                           |
|                          |                              | 3-300 s               |               |        |                      | 1SVR550130R2100  |                           |
| <sup>1)</sup>            | 24 V AC/DC                   | 0.05-1 s              | ■             | 1 c/o  | CT-AWE               | 1SVR55015 R3100  | 0.08 (0.18)               |
|                          | 110-130 V AC                 |                       |               |        |                      | 1SVR550150 R3100 |                           |
|                          | 220-240 V AC                 |                       |               |        |                      | 1SVR550151R3100  |                           |

<sup>1)</sup> without auxiliary voltage, True Off-delay timer  
<sup>2)</sup> with control input

### Synonyms

| used expression | alternative expression(s) | used expression | alternative expression(s) |
|-----------------|---------------------------|-----------------|---------------------------|
| 1 c/o contact   | SPDT                      | voltage-related | wet / non-floating        |
| 2 c/o contacts  | DPDT                      | volt-free       | dry / floating            |

## CT-E range Ordering details

### Ordering details

| Time function   | Rated control supply voltage      | Time ranges                     | Control Input | Output           | Reference code          | Catalog number       | Weight (1 pce)<br>kg (lb) |                   |                                 |             |        |                 |                |
|-----------------|-----------------------------------|---------------------------------|---------------|------------------|-------------------------|----------------------|---------------------------|-------------------|---------------------------------|-------------|--------|-----------------|----------------|
| 1□■             | 24 V AC/DC                        | 0.1-10 s<br>0.3-30 s<br>3-300 s | ■             | 1 c/o            | CT-AWE <sup>2)</sup>    | 1SVR550148R1100      | 0.08<br>(0.18)            |                   |                                 |             |        |                 |                |
|                 | 110-130 V AC                      | 1SVR550148R4100                 |               |                  |                         |                      |                           |                   |                                 |             |        |                 |                |
|                 |                                   | 1SVR550148R2100                 |               |                  |                         |                      |                           |                   |                                 |             |        |                 |                |
|                 |                                   | 1SVR550140R1100                 |               |                  |                         |                      |                           |                   |                                 |             |        |                 |                |
|                 | 220-240 V AC                      | 1SVR550140R4100                 |               |                  |                         |                      |                           |                   |                                 |             |        |                 |                |
|                 |                                   | 1SVR550140R2100                 |               |                  |                         |                      |                           |                   |                                 |             |        |                 |                |
|                 |                                   | 1SVR550141R1100                 |               |                  |                         |                      |                           |                   |                                 |             |        |                 |                |
|                 |                                   | 1SVR550141R4100                 |               |                  |                         |                      |                           |                   |                                 |             |        |                 |                |
|                 |                                   | 1SVR550141R2100                 |               |                  |                         |                      |                           |                   |                                 |             |        |                 |                |
| 1SVR550141R2100 |                                   |                                 |               |                  |                         |                      |                           |                   |                                 |             |        |                 |                |
| □■              | 24 V AC/DC,<br>220-240 V AC       | 0.1-10 s                        |               | 1 c/o            | CT-EBE <sup>7)</sup>    | 1SVR550167R1100      | 0.08<br>(0.18)            |                   |                                 |             |        |                 |                |
|                 | 110-130 V AC                      |                                 |               |                  |                         | 1SVR550160R1100      |                           |                   |                                 |             |        |                 |                |
| △□              | 24 V AC/DC,<br>220-240 V AC       | 0.1-10 s                        |               | 1 c/o            | CT-YDE <sup>1)</sup>    | 1SVR550207R1100      | 0.08<br>(0.18)            |                   |                                 |             |        |                 |                |
|                 |                                   | 0.3-30 s                        |               |                  |                         | 1SVR550207R4100      |                           |                   |                                 |             |        |                 |                |
|                 |                                   | 3-300 s                         |               |                  |                         | 1SVR550207R2100      |                           |                   |                                 |             |        |                 |                |
|                 | 110-130 V AC                      | 0.1-10 s                        |               |                  |                         | 1SVR550200R1100      |                           |                   |                                 |             |        |                 |                |
|                 |                                   | 0.3-30 s                        |               |                  |                         | 1SVR550200R4100      |                           |                   |                                 |             |        |                 |                |
|                 |                                   | 3-300 s                         |               |                  |                         | 1SVR550200R2100      |                           |                   |                                 |             |        |                 |                |
| △1□             | 24 V AC/DC,<br>220-240 V AC       | 0.3-30 s                        |               | 1 n/o + 1<br>n/c | CT-SDE <sup>3) 8)</sup> | 1SVR550217R4100      | 0.08<br>(0.18)            |                   |                                 |             |        |                 |                |
|                 | 110-130 V AC                      |                                 |               |                  |                         | 1SVR550210R4100      |                           |                   |                                 |             |        |                 |                |
|                 | 380-415 V AC                      |                                 |               |                  |                         | 1SVR550212R4100      |                           |                   |                                 |             |        |                 |                |
| 1□□<br>□□<br>□■ | 24-240<br>V AC/DC                 | 0.1-10 s,<br>3-300 s            |               |                  | CT-MKE <sup>6) 9)</sup> | 1SVR550019R0000      | 0.08<br>(0.18)            |                   |                                 |             |        |                 |                |
|                 |                                   |                                 |               |                  |                         | □                    |                           | 24-240<br>V AC/DC | 0.1-10 s<br>0.3-30 s<br>3-300 s | solid-state | CT-EKE | 1SVR550509R1000 | 0.08<br>(0.18) |
|                 |                                   |                                 |               |                  |                         |                      |                           |                   |                                 |             |        | 1SVR550509R4000 |                |
| 1SVR550509R2000 |                                   |                                 |               |                  |                         |                      |                           |                   |                                 |             |        |                 |                |
| ■               | 24-240 V AC                       | 0.1-10 s<br>0.3-30 s<br>3-300 s |               |                  | CT-AKE                  | 1SVR550519R1000      | 0.08<br>(0.18)            |                   |                                 |             |        |                 |                |
|                 |                                   |                                 |               |                  |                         | 1SVR550519R4000      |                           |                   |                                 |             |        |                 |                |
|                 |                                   |                                 |               |                  |                         | 1SVR550519R2000      |                           |                   |                                 |             |        |                 |                |
| □               | 24 V AC/DC<br>220-240 V AC/<br>DC |                                 |               | 1 c/o            | CT-IRE <sup>4)</sup>    | 1SVR550228R9100      | 0.08<br>(0.18)            |                   |                                 |             |        |                 |                |
|                 | 24 V AC/DC<br>220-240<br>V AC/DC  |                                 |               |                  |                         | CT-IRE <sup>5)</sup> |                           | 1SVR550231R9100   |                                 |             |        |                 |                |

- ON-delay
- OFF-delay
- 1□□ Impulse-ON
- 1□■ Impulse-OFF
- Flasher starting with ON
- Flasher starting with OFF
- Pulse former
- Switching relay
- △□ Star-delta change-over twice ON-delayed
- △1□ Star-delta change-over with impulse
- Pulse generator starting with ON or OFF

- 1) without auxiliary voltage
- 2) with control input
- 3) with fixed transition time
- 4) A1/A2 diagonally
- 5) A1/A2 on top
- 6) solid-state output, functions and time range selection via external jumpers
- 7) symmetric ON & OFF times
- 8) common contact
- 9) Functions: ON-delay (AC/DC), Impuls-ON (AC only), Flasher starting with OFF (AC only)

### Notice

CT...KE are solid-state timers with thyristor output for 2-wire applications. They are connected directly in series with the control coil of contactors or relays. Voltage should not be applied without a load connected, because there is no current limiting in the unit.

# CT-E range Function diagrams

## Remarks

### Legend

- Control supply voltage not applied / Output contact open
- Control supply voltage applied / Output contact closed
- A1-Y1/B1 Control input with voltage-related triggering

### Terminal designations on the device and in the diagrams

- The c/o contact is always designated **15-16/18**.
- The n/o contacts are designated with **15-16** and **15-18**.
- Control supply voltage is always applied to terminals **A1-A2/B1**.

### Function of the red LED

The red LED **R** glows as soon as the output relay energizes and turns off when the output relay de-energizes.

### ☒ ON-delay (Delay on make) CT-ERE, CT-MFE

Timing begins when control supply voltage is applied. When the selected time delay is complete, the output relay energizes.  
If control supply voltage is interrupted, the output relay de-energizes and the time delay is reset.  
Interrupting control supply voltage before the time delay is complete, resets the time delay. The output relay does not energize.  
Control input **A1-Y1** of the CT-MFE is disabled when this function is selected.

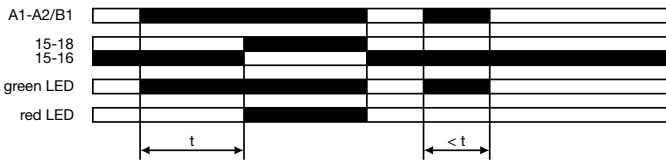

t = adjusted time delay

### ■ OFF-delay, with auxiliary voltage (Delay on break) CT-AHE, CT-MFE

This function requires continuous control supply voltage for timing.  
Timing is controlled by a control input, connected to terminals **A1-Y1**. If the control contact is closed, the output relay energizes. If control input **A1-Y1** is opened, the selected time delay starts. When the time delay is complete, the output relay de-energizes.  
If control input **A1-Y1** closes before the time delay is complete, the time delay is reset. Timing starts again when the control input re-opens.

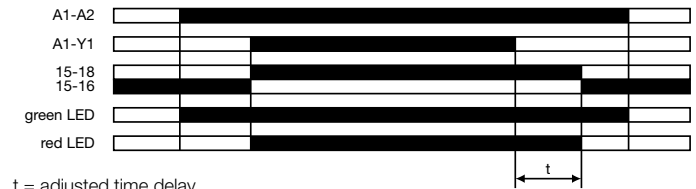

t = adjusted time delay

Minimum control pulse length: 20 ms

# CT-E range Function diagrams

## OFF-delay, without auxiliary voltage (true delay on break) CT-ARE

The OFF-delay function without auxiliary voltage does not require control supply voltage for timing.

Applying control supply voltage, energizes the output relay. If control supply voltage is interrupted, the OFF-delay starts. When timing is complete, the output relay de-energizes.

If control supply voltage is re-applied, before the time delay is complete, the time delay is reset and the output relay remains energized.

Control supply voltage must be applied for the minimum energizing time (200 ms), for proper operation.

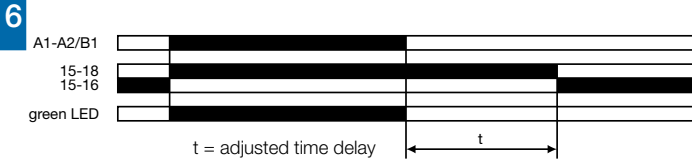

## Impulse-ON (Interval) CT-VVE, CT-MFE

The output relay energizes immediately when control supply voltage is applied and de-energizes when the selected time delay is complete.

If control supply voltage is interrupted before the time delay is complete, the output relay de-energizes and the time delay is reset.

The control input **A1-Y1** of the CT-MFE has to be jumpered if this timing function is configured.

### CT-VVE:

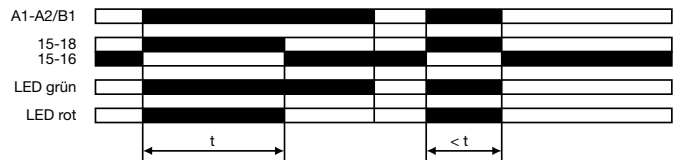

### CT-MFE:

$t = \text{adjusted pulse time}$

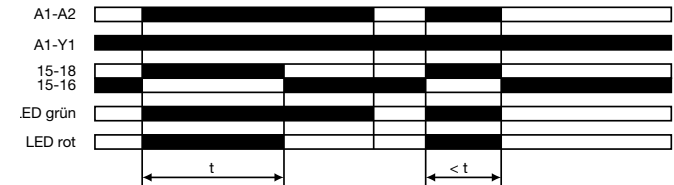

$t = \text{adjusted pulse time}$

## Impulse-OFF, without auxiliary voltage (True trailing edge interval) CT-AWE

The Impulse-OFF function without auxiliary voltage does not require control supply voltage for timing.

If control supply voltage is interrupted, the output relay energizes and the OFF time starts. When timing is complete, the output relay de-energizes.

If control supply voltage is re-applied, before the time delay is complete, the time delay is reset and the output relay de-energizes.

Control supply voltage must be applied for the minimum energizing time (200 ms), for proper operation.

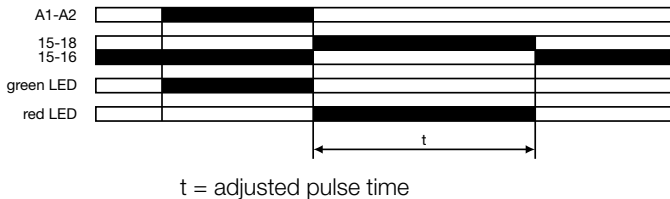

## Impulse-OFF, with auxiliary voltage (Trailing edge interval) CT-AWE

This function requires continuous control supply voltage. Opening control input **A1-Y1**, energizes the output relay immediately and timing begins. When the selected time delay is complete, the output relay de-energizes.

Interrupting control supply voltage or closing control input **A1-Y1**, before the time delay is complete, de-energizes the output relay and resets the time delay.

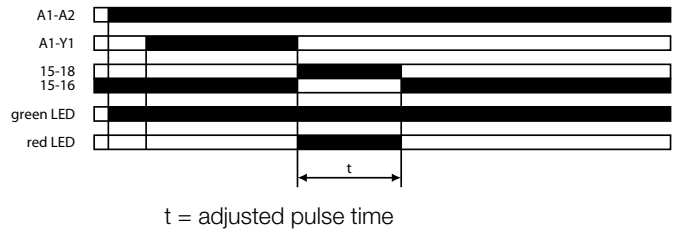

# CT-E range Function diagrams

**Flasher starting with ON  
(Recycling equal times, ON first) CT-MFE**

Applying control supply voltage, starts timing with symmetrical ON & OFF times. The cycle starts with an ON time first.  
If control supply voltage is interrupted, the output relay de-energizes and the time delay is reset.  
Control input **A1-Y1** of the CT-MFE has to be open when this function is selected.

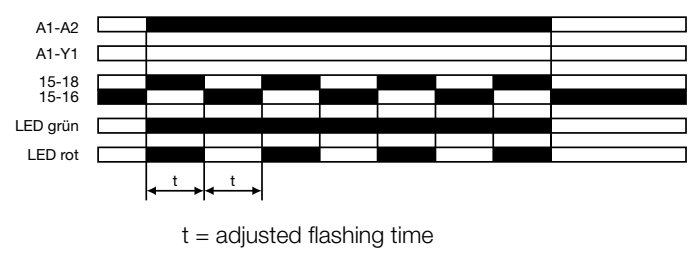

**Flasher starting with OFF  
(Recycling equal times, OFF first) CT-EBE, CT-MFE**

Applying control supply voltage, starts timing with symmetrical ON & OFF times. The cycle starts with an OFF time first.  
If control supply voltage is interrupted, the output relay de-energizes and the time delay is reset.  
Control input **A1-Y1** of the CT-MFE has to be jumpered when this function is selected.

**CT-EBE:**

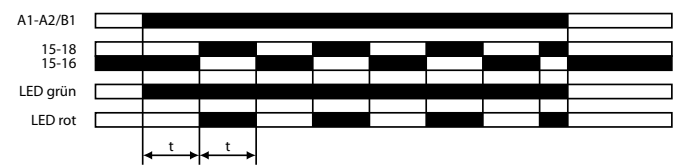

**CT-MFE:**

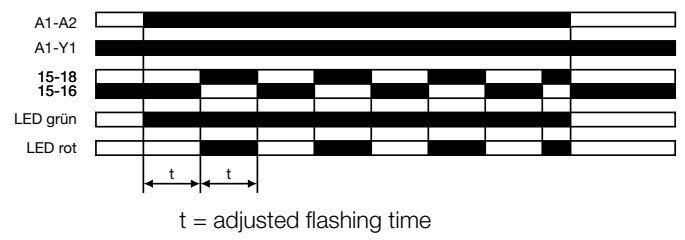

**Pulse former (Single shot)  
CT-MFE**

Closing the control input connected to terminals **A1-Y1**, with control supply voltage applied, energizes the output relay for the selected ON time. When the ON time is complete, the output relay de-energizes. Operating the control input switch **A1-Y1** during the time delay has no effect.  
After the time delay is complete, it can be restarted by closing control input **A1-Y1**.  
If control supply voltage is interrupted during timing, the output relay de-energizes and the ON time is reset.

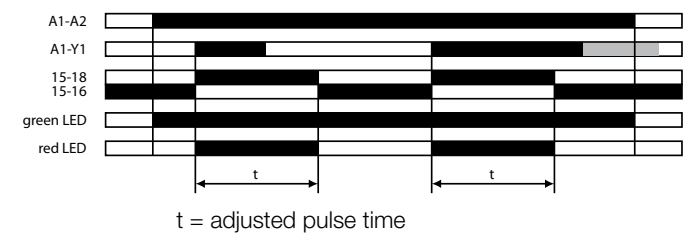

**Switching relay  
CT-IRE**

The switching relay may be used to increase the number of available contacts or to reinforce contacts, or as a coupling/decoupling interface.  
Applying control supply voltage, energizes the output relay. The output relay de-energizes if supply voltage is interrupted.



# CT-E range Function diagrams

## ⚡ CT Range Star-delta change-over CT-YDE

Applying control supply voltage, energizes the star contactor (K1) and the line contactor (K2) and begins the set starting time.

When the starting time is complete, contact 15-16 de-energizes the star contactor (K1) Now, the fixed transition time starts.

When the transition time is complete, contact 15-16 energizes the delta contactor (K3).

6

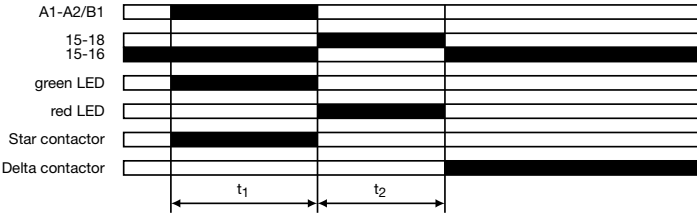

$t_1$  = adjustable starting time  
 $t_2$  = fixed transition time of 50 ms

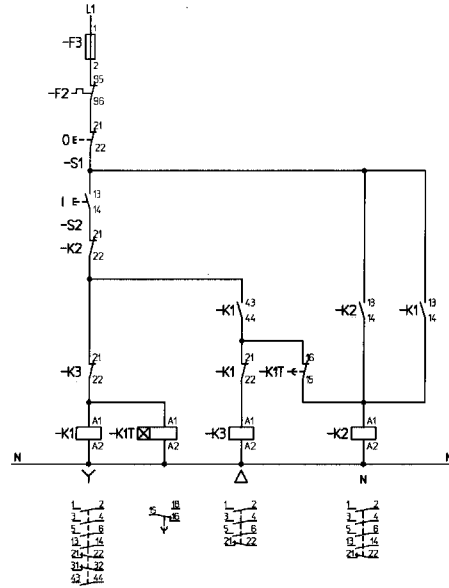

Control circuit diagram

## ⚡ Star-delta change-over CT-SDE

Applying control supply voltage, energizes the star contactor (K1) and the line contactor (K2) and begins the set starting time.

When the starting time is complete, contact 15-16 de-energizes the star contactor (K1). Now, the fixed transition time starts.

When the transition time is complete, contact 15-18 energizes the delta contactor (K3).

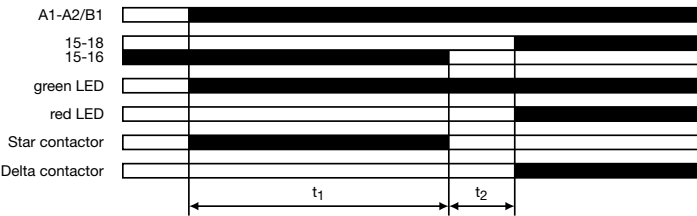

$t_1$  = adjustable starting time  
 $t_2$  = fixed transition time of 30 ms

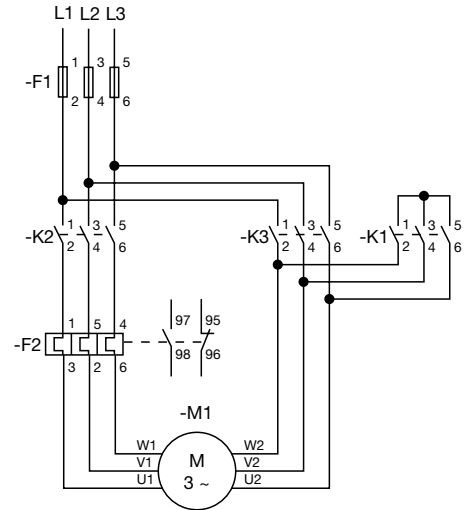

Power circuit diagram

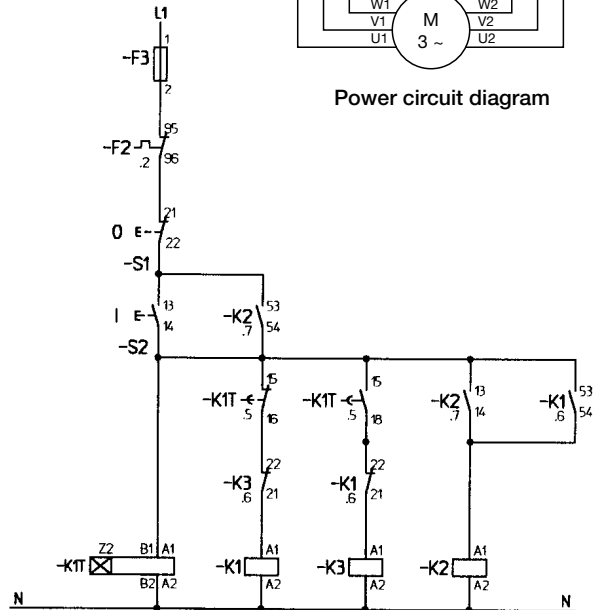

Control circuit diagram



# CT-E range Function diagrams

## Multifunction timer CT-MKE

Functions and time ranges are programmed by simply plugging in external wire jumpers.

### ☒ ON-delay (Delay on Make)

Without external connection. Timing begins when control supply voltage is applied to terminal **A1** and the load connected in series with **A2**. When the selected time delay is complete, the load connected to **A1-A2** energizes. If control supply voltage is interrupted, the load de-energizes and the time delay is reset. Interrupting control supply voltage before the time delay is complete, resets the time delay. The load does not energize.

### 1⏏ Impulse-ON (Interval)

External connection **X1-X4** required. The load energizes and timing starts when control supply voltage is applied to terminal **A1** and the load connected in series with **A2**. When the selected time delay is complete, the load de-energizes. Interrupting control supply voltage before the time delay is complete, de-energizes the load and resets the time delay.

### ⏏ Flasher, starting with ON

External connection **X1-X4** and **X2-X4** required. When control supply voltage is applied to terminal **A1** and the load connected in series with **A2**, the load energizes and de-energizes with the selected ON & OFF times. The ON & OFF times are equal. The cycle starts with an ON time first (load energized). If control supply voltage is interrupted, the load de-energizes and the time delay is reset.

### ⏏ Flasher, starting with OFF

External connection **X2-X4** required. When control supply voltage is applied to terminal **A1** and the load connected in series with **A2**, the load energizes and de-energizes with the selected ON & OFF times. The ON & OFF times are equal. The cycle starts with an OFF time first (load de-energized). If control supply voltage is interrupted, the load de-energizes and the time delay is reset.

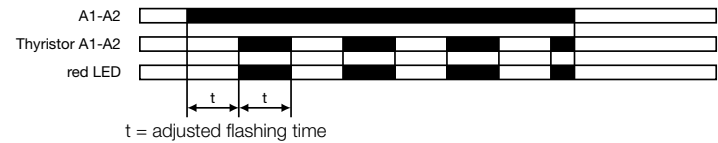
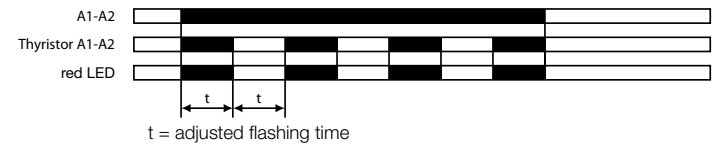
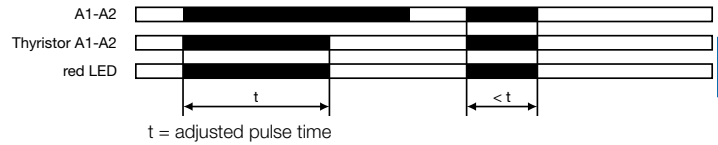
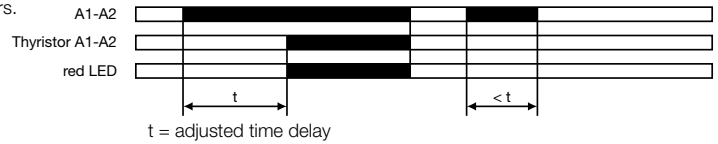

## Programming the time ranges

**X3-X4** jumpered: 0,1-10 s

**X3-X4** open: 3-300 s

### ☒ ON-delay (Delay on make) CT-EKE

Timing begins when control supply voltage is applied to terminal **A1** and the load connected in series with **AL**. When the selected time delay is complete, the load energizes. The green LED glows as long as the load is energized. If control supply voltage is interrupted, the load de-energizes and the time delay is reset. Interrupting control supply voltage before the time delay is complete, resets the time delay. The load does not energize.

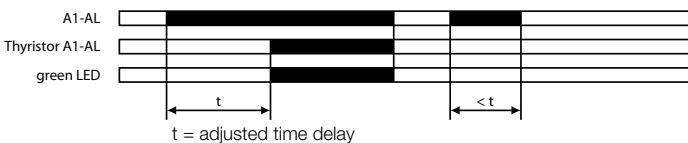

### ☐ OFF-delay, with auxiliary voltage (Delay on break) CT-AKE

The OFF-delay function with auxiliary voltage requires continuous control supply voltage at terminal **A1** and the load connected in series with **AL**, for timing. Timing is controlled by a control input, connected to terminals **Y2-A2**. When the control input closes, the load energizes. If the control input opens, the selected time delay starts (minimum control pulse length is 20 ms). The green LED glows as long as the load is energized. When the selected time delay is complete, the load de-energizes. If control input **Y2-A2** closes before the time delay is complete, the time delay is reset and the load remains energized. Timing starts again when the control input re-opens. Interrupting control supply voltage resets the time delay and de-energizes the load.

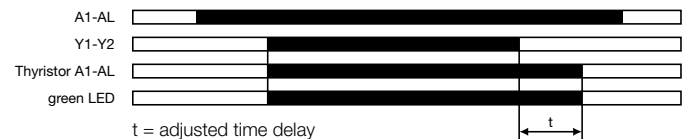

### Notice:

CT...KE are solid-state timers with thyristor output for 2-wire applications. They are connected directly in series with the control coil of contactors or relays. Voltage should not be applied without a load connected, because there is no current limiting in the unit.

# CT-E range

## Connection diagrams

6

|  |   |   |   |
|--|---|---|---|
| <p><b>CT-MFE</b></p> <p>A1-A2 Supply: 24-240 V AC/DC</p> <p>A1-Y1 Control input<br/>15-16/18 c/o contact</p> | <p><b>CT-ERE</b></p> <p>A1-A2 Supply: 220-240 V AC or 110-130 V AC</p> <p>A1-B1 Supply: 24 V AC/DC<br/>15-16/18 c/o contact</p> | <p><b>CT-AHE 1)</b></p> <p>A1(+)-A2(-) Supply: 24 V AC/DC or 110-240 V AC or 220-240 V AC</p> <p>A1-Y1 Control input<br/>15-16/18 c/o contact</p> | <p><b>CT-ARE</b></p> <p>A1-A2 Supply: 220-240 V AC or 110-130 V AC</p> <p>A1-B1 Supply: 24 V AC/DC<br/>15-16/18 c/o contact</p> |
|--|---|---|---|

|   |   |   |   |
|---|---|---|---|
| <p><b>CT-VWE</b></p> <p>A1-A2 Supply: 220-240 V AC or 110-130 V AC</p> <p>A1-B1 Supply: 24 V AC/DC<br/>15-16/18 c/o contact</p> | <p><b>CT-AWE</b></p> <p>Device without aux. voltage</p> <p>A1(+)-A2(-) Supply: 24 V AC/DC or 110-240 V AC or 220-240 V AC</p> <p>15-16/18 c/o contact</p> | <p><b>CT-AWE 1)</b></p> <p>Device with aux. voltage</p> <p>A1-A2 Supply: 24 V AC/DC or 110-240 V AC or 220-240 V AC</p> <p>A1-Y1 Control input<br/>15-16/18 c/o contact</p> | <p><b>CT-EBE</b></p> <p>A1-A2 Supply: 220-240 V AC or 110-130 V AC</p> <p>A1-B1 Supply: 24 V AC/DC<br/>15-16/18 c/o contact</p> |
|---|---|---|---|

|   |   |  |  |
|---|---|--|--|
| <p><b>CT-YDE</b></p> <p>A1-A2 Supply: 220-240 V AC or 110-130 V AC</p> <p>A1-B1 Supply: 24 V AC/DC<br/>15-16/18 c/o contact</p> | <p><b>CT-SDE</b></p> <p>Device: 1SVR 550 217 R4100</p> <p>A1-A2 Supply: 220-240 V AC</p> <p>A1-B1 Supply: 24 V AC/DC<br/>15-16/18 c/o contact</p> | <p><b>CT-SDE</b></p> <p>Devices: 1SVR 550 210 R4100, 1SVR 550 212 R4100</p> <p>A1-A2 Supply: 110-130 V AC or 380-415 V AC<br/>15-16/18 c/o contact</p> | <p><b>CT-IRE</b></p> <p>Supply terminals diagonally positioned</p> <p>A1-A2 Supply: 24 V AC/DC or 220-240 V AC/DC<br/>11-12/14 c/o contact</p> |
|---|---|--|--|

|  |  |   |   |
|--|--|---|---|
| <p><b>CT-IRE</b></p> <p>Supply terminals on one side of the device</p> <p>A1-A2 Supply: 24 V AC/DC or 220-240 V AC/DC<br/>11-12/14 c/o contact</p> | <p><b>CT-MKE</b></p> <p>A1-A2 Supply: 24-240 V AC/DC</p> <p>A1-A2 Thyristor</p> <p>X1-X4 Timing function adjustment</p> <p>X2-X4 Timing function adjustment</p> <p>X3-X4 Time range adjustment<br/>(Details see function diagrams)</p> | <p><b>CT-EKE</b></p> <p>A1-AL Supply: 24-240 V AC/DC</p> <p>A1-AL Thyristor</p> | <p><b>CT-AKE</b></p> <p>A1-AL Supply: 24-240 V AC</p> <p>A1-AL Thyristor</p> <p>Y2-A2 Control input</p> |
|--|--|---|---|

# CT-E range

## Technical data

### Technical data

Data at  $T_a = 25\text{ °C}$  and rated values, unless otherwise indicated

|  |   | CT-E (relays)   | CT-E (solid-state)                  |              |
|--|---|---|-------------------------------------|--------------|
| <b>Input circuit - Supply circuit</b>                      |   |   |                                     |              |
| Rated control supply voltage $U_s$                         | A1-A2, A1-AL                                  | 24-240 V AC/DC  |                                     |              |
|  | A1-A2, A1-AL                                  | 24-240 V AC   |                                     |              |
|  | A1-A2   | 110-130 V AC  | -                                   |              |
|  | A1-A2   | 220-240 V AC  | -                                   |              |
|  | A1-A2   | 380-415 V AC  | -                                   |              |
| Rated control supply voltage $U_s$ tolerance               | A1-B1   | 24 V AC/DC  | -                                   |              |
|  |   |   | -15...+10 %                         |              |
| Rated frequency  | AC/DC versions                                |   | DC or 50/60 Hz                      |              |
|  | AC versions                                   |   | 50/60 Hz                            |              |
| Typical current / power consumption                        | 24-240 V AC/DC, 24-240 V AC                   |   | approx. 1.0-2.0 VA/W                |              |
|  | 110-130 V AC, 220-240 V AC                    | approx. 2.0 VA  | -                                   |              |
|  | 380-415 V AC                                  | approx. 3.0 VA  | -                                   |              |
|  | 24 V AC/DC                                    | approx. 1.0 VA/W                                      | -                                   |              |
| Current consumption while timing                           |   | -   | $\leq 2\text{ mA}$ (24-60 V AC/DC)  |              |
|  |   |   | $\leq 8\text{ mA}$ (60-240 V AC/DC) |              |
| <b>Input circuit - Control circuit</b>                     |   |   |                                     |              |
| Kind of triggering   |   | voltage-related triggering                            | -                                   |              |
| Control input, Control function                            | A1-Y1   | start timing external                                 | -                                   |              |
| Parallel load / polarized                                  |   | no / yes <sup>1)</sup>                                | -                                   |              |
| Minimum control pulse length                               |   | 20 ms   | -                                   |              |
| Control voltage potential                                  |   | see rated control supply voltage                      | -                                   |              |
| <b>Timing circuit</b>                                      |   |   |                                     |              |
| Time ranges  | 1 of 5 time ranges per single function device | 0.05-1 s / 0.1-10 s / 0.3-30 s / 3-300 s / 0.3-30 min |                                     |              |
|  | 8 time ranges 0.05 s - 100 h (CT-MFE)         | 1.) 0.05-1 s  | 2.) 0.5-10 s                        | -            |
|  |   | 3.) 5-100 s   | 4.) 50-1000 s                       |              |
|  |   | 5.) 0.5-10 min  | 6.) 5-100 min                       |              |
|  |   | 7.) 0.5-10 h  | 8.) 5-100 h                         |              |
|  | 2 time ranges 0.1-300 s (CT-MKE)              |   |                                     | 1.) 0.1-10 s |
|  |   |   |                                     | 2.) 3-300 s  |
|  | Recovery time                                 |   | <50 ms                              |              |
|  |   | CT-ARE: <200 ms                                       | CT-MKE: <100 ms                     |              |
|  |   | CT-AWE, CT-SDE: <400 ms                               | CT-AKE: <300 ms                     |              |
|  |   | CT-YDE: <500 ms                                       |                                     |              |
| Accuracy within the rated control supply voltage tolerance |   | $\Delta t < 0.5\% / V$                                |                                     |              |
| Accuracy within the temperature range                      |   | $\Delta t < 0.1\% / \text{°C}$                        |                                     |              |
| Repeat accuracy (constant parameters)                      |   | CT-MFE: $\Delta t < 0.06\% / \text{°C}$               |                                     |              |
| Star-delta transition time                                 | CT-YDE / CT-SDE                               | 50 ms / 30 ms   | -                                   |              |
| Minimum energizing time                                    | CT-ARE  | 200 ms  | -                                   |              |
| <b>Output circuit</b>                                      |   |   |                                     |              |
| Kind of output   | 15-16/18                                      | Relay, 1 c/o contact                                  | -                                   |              |
|  | A1-A2, A1-AL                                  | -   | Thyristor                           |              |
| Contact material   |   | AgCdO   | -                                   |              |
| Rated operational voltage $U_b$                            | VDE 0110, IEC/EN 60947-1                      |   | 250 V                               |              |
| Maximum switching voltage                                  |   | 250 V AC, 250 V DC                                    |                                     |              |
| Rated operational current $I_b$<br>(IEC/EN 60947-5-1)      | AC12 (resistive) at 230 V                     | 4 A   | -                                   |              |
|  | AC15 (inductive) at 230 V                     | 3 A   | -                                   |              |
|  | AC15 (inductive) at 230 V                     | 4 A   | -                                   |              |
|  | DC13 (inductive) at 24 V                      | 2 A   | -                                   |              |

<sup>1)</sup> CT-MFE: yes / no

# CT-E range

## Technical data

6

|   |   | CT-E (relays)                          | CT-E (solid-state)   |
|---|---|--|--|
| AC rating (UL 508)  | Utilization category<br>(Control Circuit Rating Code) | B 300                                  | -  |
|   | max. rated operational voltage                        | 300 V AC                               | -  |
|   | Maximum continuous thermal current<br>at B300         | 5 A                                    | -  |
|   | max. making/breaking apparent power<br>at B300        | 3600 VA / 360 VA                       | -  |
| Mechanical lifetime   |   | 30 x 10 <sup>6</sup> switching cycles  | -  |
| Electrical lifetime   | at AC12, 230 V, 4 A                                   | 0.1 x 10 <sup>6</sup> switching cycles | -  |
| Max. fuse rating to achieve short-circuit<br>protection (IEC/EN 60947-5-1)                                  | n/c contact   | 10 A fast-acting, CT-ARE: 5 A          | -  |
|   | n/o contact   | 10 A fast-acting, CT-ARE: 5 A          | -  |
| Minimum load current  |   | -                                      | CT-MKE: 20 mA<br>CT-EKE, CT-AKE: 10 mA                     |
| Maximum load current  |   | -                                      | CT-MKE: ≤ 0.8 A at Ta = ≤ 20 °C<br>CT-EKE, CT-AKE: ≤ 0.7 A |
| Load current reduction / Derating   |   | -                                      | 10 mA/°C   |
| Maximum surge current   |   | -                                      | CT-MKE: 20 A for t 20 ms<br>CT-EKE, CT-AKE: 15 A           |
| Voltage drop in connected state   |   | -                                      | ≤ 3 V  |
|   | at 24 V AC  | -                                      | 220 m / 22 nF  |
| Cable length between solid-state timer and<br>connected load at 50 Hz and a cable capacity of<br>100 pF/m : | at 42 V AC  | -                                      | 100 m / 10 nF  |
|   | at 60 V AC  | -                                      | 65 m / 6.5 nF  |
|   | at 110 V AC   | -                                      | 50 m / 5 nF  |
|   | at 240 V AC   | -                                      | 22 m / 2.2 nF  |
| <b>General data</b>   |   |  |  |
| Duty time   |   |  | 100%   |
| Dimensions (W x H x D)  |   |  | 22.5 x 78.5 x 78 mm (0.886 x 3.09 x 3.07 in)               |
| Weight  |   |  | approx. 80 g (0.176 lb)                                    |
| Mounting  |   |  | DIN rail (IEC/EN 60715)                                    |
| Mounting position   |   |  | any  |
| Minimum distance to other units   | horizontal / vertical                                 |  | no / no  |
| Degree of protection  | housing / terminals                                   |  | IP50 / IP20  |
| <b>Electrical connection</b>  |   |  |  |
| Wire size   | fine-strand with wire end ferrule                     |  | 2 x 0.75-1.5 mm <sup>2</sup> (2 x 18-16 AWG)               |
|   | fine-strand without wire end ferrule                  |  | 2 x 1-1.5 mm <sup>2</sup> (2 x 18-16 AWG)                  |
|   | rigid   |  | 2 x 0.75-1.5 mm <sup>2</sup> (2 x 18-16 AWG)               |
| Stripping length  |   |  | 10 mm (0.39 in)  |
| Tightening torque   |   |  | 0.6-0.8 Nm   |
| <b>Environmental data</b>   |   |  |  |
| Ambient temperature ranges  | operation / storage                                   |  | -20...+60 °C / -40...+85 °C                                |
| Damp heat   | IEC 68-2-30   |  | 24 h cycles, 55 °C, 93 % rel., 96 h                        |
| Operational reliability   | IEC 68-2-6  |  | 6 g  |
| Mechanical resistance   | IEC 68-2-6  |  | 10 g   |
| <b>Isolation data</b>   |   |  |  |
| Rated impulse withstand voltage U <sub>imp</sub><br>between all isolated circuits                           | VDE 0110, IEC/EN 664                                  |  | 4 kV; 1.2/50 µs  |
| Pollution category  | VDE 0110, IEC 664, IEC 255-5                          |  | III/C  |
| Overvoltage category  | VDE 0110, IEC 664, IEC 255-5                          |  | III/C  |
| Rated insulation voltage U <sub>i</sub> between supply<br>circuit, control circuit and output circuit       | input circuit / output circuit                        |  | 300 V (supply up to 240 V)                                 |
|   | type test   |  | 500 V (supply up to 440 V)                                 |
| Test voltage between all isolated circuits  |   |  | 2.5 kV, 50 Hz, 1 s   |
| <b>Standards</b>  |   |  |  |
| Product standard  |   |  | IEC 61812-1, EN 61812-1 + A11, DIN VDE 0435 Teil 201       |
| Low Voltage Directive   |   |  | 2006/95/EC   |
| EMC Directive   |   |  | 2004/108/EC  |
| <b>Electromagnetic compatibility</b>  |   |  |  |
| Interference immunity to  |   |  | IEC/EN 61000-6-2   |
| electronic discharge  | IEC/EN 61000-4-2                                      |  | Level 3 (6 kV / 8 kV)                                      |
| radiated, radio-frequency<br>electromagnetic field  | IEC/EN 61000-4-3                                      |  | Level 3 (10 V/m)   |
| electrical fast transient/burst<br>surge  | IEC/EN 61000-4-4                                      |  | Level 3 (2 kV / 5 kHz)                                     |
| conducted disturbances, induced by radio-frequency fields   | IEC/EN 61000-4-5                                      |  | Level 3 (2 kV L-L)   |
|   | IEC/EN 61000-4-6                                      |  | Level 3 (10 V)   |
| Interference emissions  |   |  | IEC/EN 61000-6-4   |

# CT-E range Technical diagrams

## Technical diagrams

Load limit curves  
AC load (resistive)

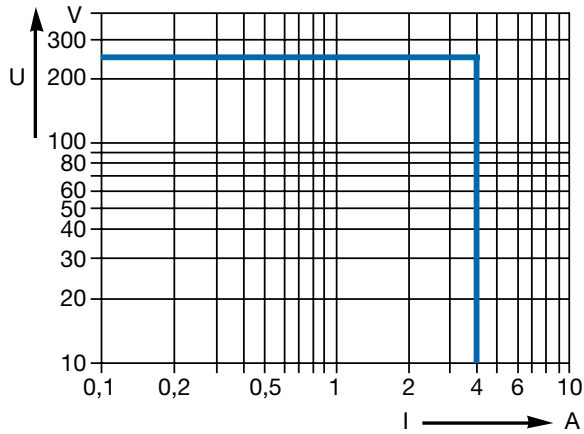

DC load (resistive)

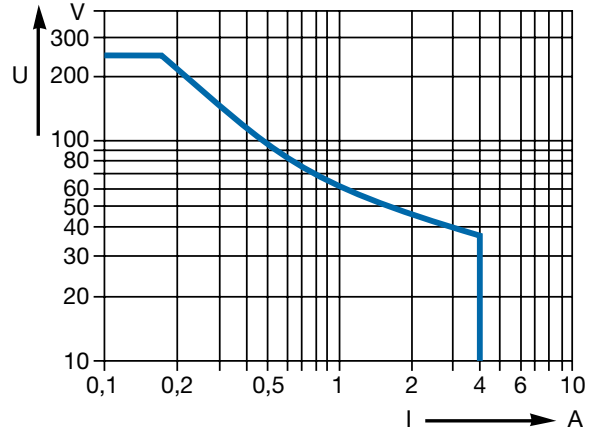

6

Derating factor F for inductive AC load

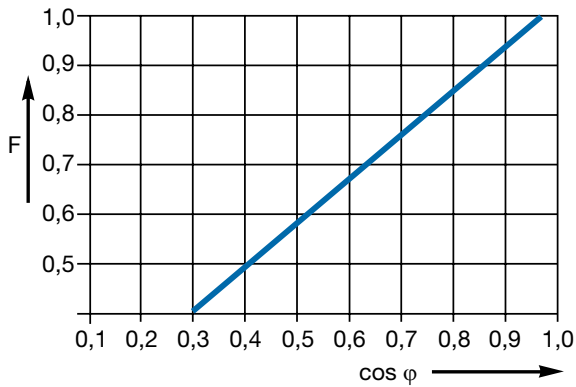

Contact lifetime

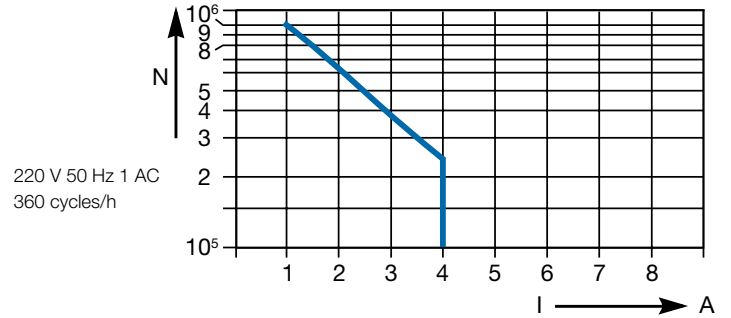

# CT-E range

## Wiring notes

### Approximate dimensions

### Wiring notes

for single-function devices with control contact  
(CT-AHE, CT-AWE with auxiliary voltage)

6

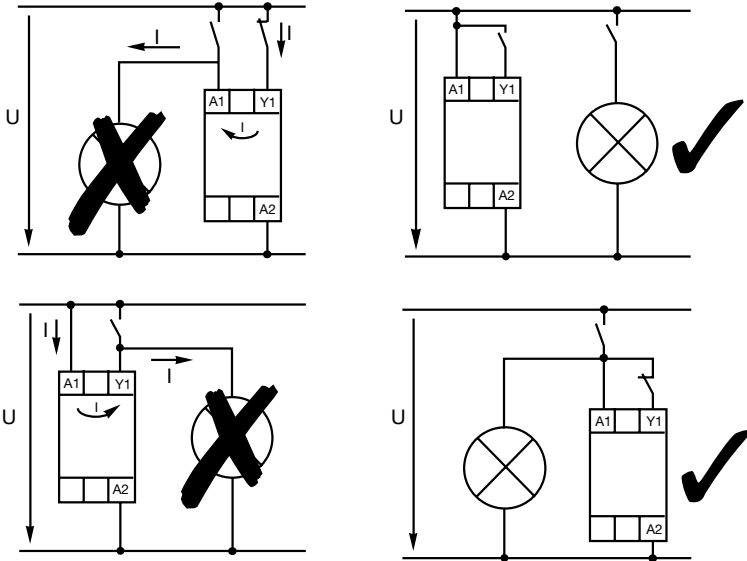

### Dimensional drawing

Dimensions in mm

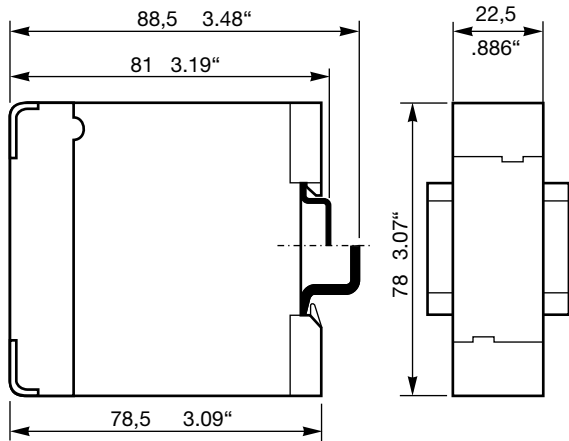

# CT-S Range Electronic timers



# CT-S range

## Benefits and advantages

### Characteristics

- Diversity:
  - 8 multifunction timers
  - 13 single-function timers
  - 8 switching relays
- Control supply voltages:
  - Multi range: 24-48 V DC, 24-240 V AC
  - Wide range: 24-240 V AC/DC
  - Single range: 380-440 V AC
- Innovative connection technology
  - Double-chamber cage connection terminals
  - Easy Connect Technology
- Devices with:
  - 1 or 2 c/o contacts
  - 2nd c/o contact can be selected as instantaneous contact <sup>1)</sup>
  - Remote potentiometer connection <sup>1)</sup>
  - Control input with volt-free or voltage-related triggering e.g. to start timing, pause timing
  - Extended operating temperature range down to -40 °C <sup>1)</sup>
- Sealable transparent cover for protection against unauthorized changes of time values
- Integrated marker label
- Approvals / Marks (partly pending)



<sup>1)</sup> selected devices

6

### Synonyms

| used expression | alternative expression(s) | used expression | alternative expression(s) |
|-----------------|---------------------------|-----------------|---------------------------|
| 1 c/o contact   | SPDT                      | voltage-related | wet / non-floating        |
| 2 c/o contacts  | DPDT                      | volt-free       | dry / floating            |

### Benefits

#### Easy Connect Technology <sup>①</sup>

Tool-free wiring and excellent vibration resistance. Push-in terminals provide connection of wires up to 2 x 0,5 - 1,5 mm<sup>2</sup> (2 x 20 - 16 AWG), rigid or fine-strand with or without wire end ferrules.

#### Double-chamber cage connection terminals <sup>②</sup>

Double-chamber cage connection terminals provide connection of wires up to 2 x 0,5-2,5 mm<sup>2</sup> (2 x 20-14 AWG) rigid or fine-strand, with or without wire end ferrules. Potential distribution does not require additional terminals.

#### Snap-On housing

Tool-free DIN rail installation and deinstallation of the Electronic Timer with Snap-On housing.

#### Time range preselection and fine adjustment <sup>③</sup>

Direct assignment of the preselected time range to the fine adjustment potentiometer scale by multicolor scales.

#### LEDs for status indication <sup>④</sup>

All actual operational states are displayed by front-face LED's, thus simplifying commissioning and troubleshooting.

#### Integrated marker label <sup>⑤</sup>

Integrated marker labels allow the product to be marked quickly and simply. No additional marker labels are required.

#### Sealable transparent cover <sup>⑥</sup>

Protection against unauthorized changes of time and threshold values. Available as an accessory.

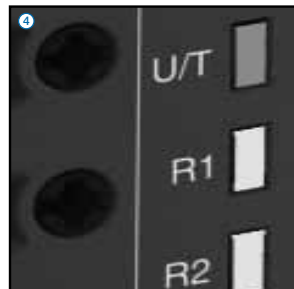
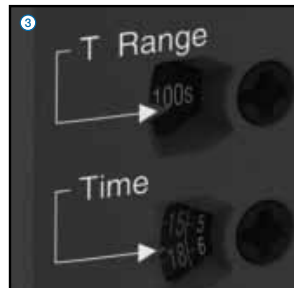
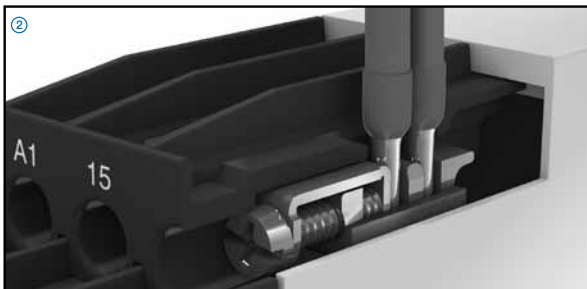
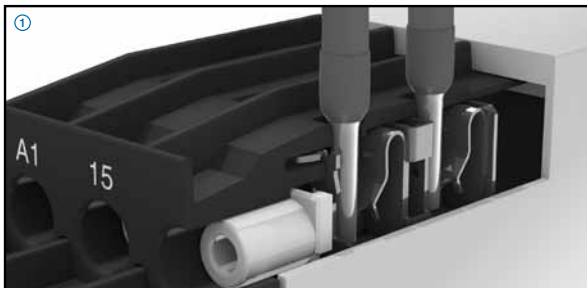



## CT-S range Conversion table



### Previous Generation

|                 |           |
|-----------------|-----------|
| 1SVR630010R0200 | CT-MFS.21 |
| 1SVR630010R3200 | CT-MBS.22 |
| 1SVR630020R0200 | CT-MVS.21 |
| 1SVR630020R3100 | CT-MVS.12 |
| 1SVR630020R3300 | CT-MVS.22 |
| 1SVR630021R2300 | CT-MVS.23 |
| 1SVR630030R3300 | CT-MXS.22 |
| 1SVR630040R3300 | CT-WBS.22 |
| 1SVR630100R0300 | CT-ERS.21 |
| 1SVR630100R3100 | CT-ERS.12 |
| 1SVR630100R3300 | CT-ERS.22 |
| 1SVR630110R3300 | CT-AHS.22 |
| 1SVR630120R3100 | CT-ARS.11 |
| 1SVR630120R3300 | CT-ARS.21 |
| 1SVR630180R0300 | CT-APS.21 |
| 1SVR630180R3100 | CT-APS.12 |
| 1SVR630180R3300 | CT-APS.22 |
| 1SVR630210R3300 | CT-SDS.22 |
| 1SVR630211R2300 | CT-SDS.23 |

### New Generation

#### Double-chamber cage connection terminals

|                 |            |
|-----------------|------------|
| 1SVR730010R0200 | CT-MFS.21S |
| 1SVR730010R3200 | CT-MBS.22S |
| 1SVR730020R0200 | CT-MVS.21S |
| 1SVR730020R3100 | CT-MVS.12S |
| 1SVR730020R3300 | CT-MVS.22S |
| 1SVR730021R2300 | CT-MVS.23S |
| 1SVR730030R3300 | CT-MXS.22S |
| 1SVR730040R3300 | CT-WBS.22S |
| 1SVR730100R0300 | CT-ERS.21S |
| 1SVR730100R3100 | CT-ERS.12S |
| 1SVR730100R3300 | CT-ERS.22S |
| 1SVR730110R3300 | CT-AHS.22S |
| 1SVR730120R3100 | CT-ARS.11S |
| 1SVR730120R3300 | CT-ARS.21S |
| 1SVR730180R0300 | CT-APS.21S |
| 1SVR730180R3100 | CT-APS.12S |
| 1SVR730180R3300 | CT-APS.22S |
| 1SVR730210R3300 | CT-SDS.22S |
| 1SVR730211R2300 | CT-SDS.23S |

#### Easy Connect Technology

|                 |            |
|-----------------|------------|
| 1SVR740010R0200 | CT-MFS.21P |
| 1SVR740010R3200 | CT-MBS.22P |
| 1SVR740020R0200 | CT-MVS.21P |
| 1SVR740020R3100 | CT-MVS.12P |
| 1SVR740020R3300 | CT-MVS.22P |
| 1SVR740021R2300 | CT-MVS.23P |
| 1SVR740030R3300 | CT-MXS.22P |
| 1SVR740040R3300 | CT-WBS.22P |
| 1SVR740100R0300 | CT-ERS.21P |
| 1SVR740100R3100 | CT-ERS.12P |
| 1SVR740100R3300 | CT-ERS.22P |
| 1SVR740110R3300 | CT-AHS.22P |
| 1SVR740120R3100 | CT-ARS.11P |
| 1SVR740120R3300 | CT-ARS.21P |
| 1SVR740180R0300 | CT-APS.21P |
| 1SVR740180R3100 | CT-APS.12P |
| 1SVR740180R3300 | CT-APS.22P |
| 1SVR740210R3300 | CT-SDS.22P |
| 1SVR740211R2300 | CT-SDS.23P |

## ABB's electronic timers in a new housing Benefits at a glance

### Double-chamber cage connection terminals

#### Easy conversions:

The predecessor range of electronic timers is replaced by an identical range of electronic timers with double-chamber cage connection terminals.

The Reference code has changed in one digit only:

1SVRx changed to 1SVR7.

#### Ratings:

Double-chamber cage connection terminals provide connection of wires up to 1 x 0,5-4 mm<sup>2</sup> (1 x 20-12 AWG) or 2 x 0,5-2,5 mm<sup>2</sup> (2 x 20-14 AWG) rigid or 1 x 0,5-2,5 mm<sup>2</sup> (1 x 20-14 AWG) / 2 x 0,5-1,5 mm<sup>2</sup> (2 x 20 -16 AWG), rigid or fine-strand, with or without wire end ferrules. Potential distribution does not require additional terminals.

#### Extended type designators

The references with push-in terminals or screw terminals can be differentiated easily by the extended type designator:

CT-xxS.xxS indicates the screw terminal

CT-xxS.xxP indicates the push-in terminal

### Easy Connect Technology

#### New Options:

In addition to our existing well established screw connections, ABB introduces a new innovative connection technology: Easy Connect Technology with push-in terminals.

#### Tool-Free Wiring:

The push-in terminals can be wired with rigid or fine-strand wires with wire end ferrules totally tool-free. The connection direction is exactly the same as for the screw version.

#### Higher utility class:

The Easy Connect Technology provides excellent vibration resistance with gas tight push-in terminals – the right solution for harsh environment.

#### Ratings:

Push-in terminals provide connection of wires up to 2 x 0,5 - 1,5 mm<sup>2</sup> (2 x 20-16 AWG), rigid or fine-strand with or without wire end ferrules.

## CT-S range Ordering details



CT-MVS.21P

### Description

The highly sophisticated CT-S range in ABB's new S-range housing offers two different types of connection terminals and is ideally suited for universal use. Two different connection technologies are available:

- Double-chamber cage connection terminals:
- Easy Connect Technology:

### Accessories:

The CT-S range offers the possibility of using accessories such as a remote potentiometer to adjust the time delay or a sealable, transparent cover to protect against unauthorized changes of time and threshold values.

### Ordering details



CT-MBS.22P

| Time function | Rated control supply voltage                     | Time ranges           | Control input | Output | Reference code  | Catalog number  | Weight (1 pce)<br>kg (lb) |
|---------------|--|-----------------------|---------------|--------|-----------------|-----------------|---------------------------|
|               | 24-240 V AC/DC <sup>2)</sup><br><sup>3) 4)</sup> | 10 (0.05 s-300 h)     | ■             | 2 c/o  | CT-MVS.21S      | 1SVR730020R0200 | 0.148 (0.326)             |
|               |  |                       |               |        | CT-MVS.21P      | 1SVR740020R0200 | 0.136 (0.300)             |
|               | CT-MVS.22S                                       |                       |               |        | 1SVR730020R3300 | 0.142 (0.313)   |                           |
|               | CT-MVS.22P                                       |                       |               |        | 1SVR740020R3300 | 0.131 (0.289)   |                           |
|               | CT-MVS.23S                                       |                       |               |        | 1SVR730021R2300 | 0.144 (0.317)   |                           |
|               | CT-MVS.23P                                       |                       |               |        | 1SVR740021R2300 | 0.133 (0.293)   |                           |
|               | 24-48 V DC, 24-240 V AC                          | 10 (0.05 s-300 h)     | ■             | 1 c/o  | CT-MVS.12S      | 1SVR730020R3100 | 0.107 (0.236)             |
|               |  |                       |               |        | CT-MVS.12P      | 1SVR740020R3100 | 0.102 (0.225)             |
|               | 24-48 V DC, 24-240 V AC <sup>5)</sup>            | 2 x 10 (0.05 s-300 h) | ■             | 2 c/o  | CT-MXS.22S      | 1SVR730030R3300 | 0.142 (0.313)             |
|               |  |                       |               |        | CT-MXS.22P      | 1SVR740030R3300 | 0.131 (0.289)             |
|               | 24-240 V AC/DC <sup>2)</sup><br><sup>3) 4)</sup> | 10 (0.05 s-300 h)     | ◇/◇           | 2 c/o  | CT-MFS.21S      | 1SVR730010R0200 | 0.145 (0.320)             |
|               |  |                       |               |        | CT-MFS.21P      | 1SVR740010R0200 | 0.133 (0.293)             |
|               | CT-MBS.22S                                       |                       |               |        | 1SVR730010R3200 | 0.140 (0.309)   |                           |
|               | CT-MBS.22P                                       |                       |               |        | 1SVR740010R3200 | 0.129 (0.284)   |                           |

- ON-delay (accumulative)  
OFF-delay without aux. voltage
- Impulse-ON
- Impulse-OFF
- Symmetrical ON-delay and OFF-delay
- Flasher starting with ON
- Flasher starting with OFF
- Pulse generator starting
- Star-delta change-over with impulse
- Pulse former
- ON/OFF-function
- Star-delta change-over twice ON-delayed with ON or OFF
- Pulse generator starting with ON or OFF
- Single-pulse generator
- Impulse-ON/OFF
- Flasher starting with ON
- Flasher starting with OFF
- fixed impulse with adjustable time delay
- Adjustable impulse with fixed time delay

- 1) Asymmetrical ON- and OFF-delay
- 2) Extended temperature range -40 °C
- 3) Remote potentiometer connection
- 4) 2nd c/o contact selectable as instantaneous contact
- 5) 2 remote potentiometer connections

- Control input with voltage-related triggering
- ◇ Control input with volt-free triggering

# CT-S range

## Ordering details















CT-ERS.21P















CT-AHS.22P





CT-SDS.23P

-  ON-delay (accumulative)
-  OFF-delay without aux. voltage
-  Impulse-ON
-  Flasher starting with ON
-  Flasher starting with OFF
-  ON/OFF-function
-  Impulse-ON/OFF
-  Flasher starting with ON
-  Flasher starting with OFF
-  fixed impulse with adjustable time delay
-  Adjustable impulse with fixed time delay
-  Star-delta change-over

| Time function  | Rated control supply voltage      | Time ranges           | Control input   | Output | Reference code  | Catalog number        | Weight (1 pce)<br>kg (lb) |                  |                 |                  |
|--|-----------------------------------|-----------------------|---|--------|---|-----------------------|---------------------------|------------------|-----------------|------------------|
| <br><br><br><br><br> | 24-48 V DC,<br>24-240 V AC        | 10 (0.05 s-<br>300 h) |   | 2 c/o  | CT-WBS.22S  | 1SVR730040R3300       | 0.123<br>(0.271)          |                  |                 |                  |
|  |                                   |                       |   |        | CT-WBS.22P  | 1SVR740040R3300       | 0.115<br>(0.254)          |                  |                 |                  |
|   | 24-240 V AC/<br>DC 2)             | 10 (0.05 s-<br>300 h) |   | 2 c/o  | CT-ERS.21S  | 1SVR730100R0300       | 0.130<br>(0.287)          |                  |                 |                  |
|  | 24-48 V DC,<br>24-240 V AC        |                       |   |        | CT-ERS.21P  | 1SVR740100R0300       | 0.121<br>(0.267)          |                  |                 |                  |
|  |                                   |                       |   |        | CT-ERS.22S  | 1SVR730100R3300       | 0.121<br>(0.267)          |                  |                 |                  |
|  | 24-48 V DC,<br>24-240 V AC        |                       |   |        | CT-ERS.22P  | 1SVR740100R3300       | 0.113<br>(0.249)          |                  |                 |                  |
|  |                                   |                       |   |        | 1 c/o   | CT-ERS.12S            | 1SVR730100R3100           | 0.106<br>(0.234) |                 |                  |
|  | CT-ERS.12P                        |                       |   |        |   | 1SVR740100R3100       | 0.101<br>(0.222)          |                  |                 |                  |
|   | 24-240 V AC/<br>DC 2)             | 10 (0.05 s-<br>300 h) |  | 2 c/o  | CT-APS.21S  | 1SVR730180R0300       | 0.146<br>(0.322)          |                  |                 |                  |
|  | 24-48 V DC,<br>24-240 V AC        |                       |   |        | CT-APS.21P  | 1SVR740180R0300       | 0.125<br>(0.276)          |                  |                 |                  |
|  |                                   |                       |   |        | CT-APS.22S  | 1SVR730180R3300       | 0.138<br>(0.304)          |                  |                 |                  |
|  | 1 c/o                             |                       |   |        | CT-APS.22P  | 1SVR740180R3300       | 0.127<br>(0.280)          |                  |                 |                  |
|  |                                   |                       |   |        | 1 c/o   | CT-APS.12S            | 1SVR730180R3100           | 0.109<br>(0.240) |                 |                  |
|  | 24-48 V DC,<br>24-240 V AC        |                       |   |        |   | CT-APS.12P            | 1SVR740180R3100           | 0.103<br>(0.227) |                 |                  |
|  |                                   |                       |   |        |  | 10 (0.05 s-<br>300 h) |                           | 2 c/o            | CT-AHS.22S      | 1SVR730110R3300  |
|  | CT-AHS.22P                        |                       |   |        |   |                       |                           |                  | 1SVR740110R3300 | 0.125<br>(0.276) |
|  6)   | 24-240 V<br>AC/DC                 | 7 (0.05 s- 10<br>min) |   | 1 c/o  | CT-ARS.11S  | 1SVR730120R3100       | 0.106<br>(0.234)          |                  |                 |                  |
|  |                                   |                       |   |        | CT-ARS.11P  | 1SVR740120R3100       | 0.100<br>(0.220)          |                  |                 |                  |
|  |                                   |                       |   |        | 2 c/o   | CT-ARS.21S            | 1SVR730120R3300           | 0.124<br>(0.273) |                 |                  |
|  |                                   |                       |   |        |   | CT-ARS.21P            | 1SVR740120R3300           | 0.115<br>(0.254) |                 |                  |
|  6)   | 110-127 V<br>AC or<br>110 V DC 8) |                       |   |        | CT-VBS.17   | 1SVR430261R6000       | 0.123<br>(0.271)          |                  |                 |                  |
|  | 200-240 V<br>AC/DC 8)             |                       |   |        | CT-VBS.18   | 1SVR430261R5000       | 0.118<br>(0.260)          |                  |                 |                  |
|  7)   | 24-48 V DC,<br>24-240 V AC        | 7 (0.05 s- 10<br>min) |   | 2 n/o  | CT-SDS.22S  | 1SVR730210R3300       | 0.114<br>(0.251)          |                  |                 |                  |
|  |                                   |                       |   |        | CT-SDS.22P  | 1SVR740210R3300       | 0.108<br>(0.238)          |                  |                 |                  |
|  |                                   |                       |   |        | 380-440<br>V AC   | CT-SDS.23S            | 1SVR730211R2300           | 0.118<br>(0.260) |                 |                  |
|  |                                   |                       |   |        |   | CT-SDS.23P            | 1SVR740211R2300           | 0.112<br>(0.247) |                 |                  |

- 1) Asymmetrical ON- and OFF-delay
- 2) Extended temperature range -40 °C
- 3) Remote potentiometer connection
- 4) 2nd c/o contact selectable as instantaneously contact
- 5) 2 remote potentiometer connections
- 6) Without auxiliary voltage
- 7) 50 ms transition time
- 8) For DC contactor coils

-  Control input with voltage-related triggering
-  Control input with volt-free triggering

## CT-S range Ordering details



CT-IRS.35

6



ON/OFF-function

| Time function | Rated control supply voltage | Time ranges | Control input | Output | Reference code           | Catalog number  | Weight (1 pce)<br>kg (lb) |
|---------------|------------------------------|-------------|---------------|--------|--------------------------|-----------------|---------------------------|
| □             | 24 V AC/DC                   |             |               | 2 c/o  | CT-IRS.16                | 1SVR430220R9100 | 0.121<br>(0.267)          |
|               | 110-240 V AC                 |             |               |        | CT-IRS.14                | 1SVR430221R7100 | 0.126<br>(0.278)          |
|               | 24 V AC/DC                   |             |               |        | CT-IRS.26                | 1SVR430220R9300 | 0.135<br>(0.298)          |
|               | 110-240 V AC                 |             |               |        | CT-IRS.24                | 1SVR430221R7300 | 0.141<br>(0.311)          |
|               | 24 V AC/DC                   |             |               | 2 c/o  | CT-IRS.26G <sup>9)</sup> | 1SVR430230R9300 | 0.147<br>(0.324)          |
|               | 110-240 V AC                 |             |               |        | CT-IRS.24G <sup>9)</sup> | 1SVR430231R7300 | 0.150<br>(0.331)          |
|               | 24 V AC/DC                   |             |               | 3 c/o  | CT-IRS.36                | 1SVR430220R9400 | 0.159<br>(0.351)          |
|               | 220-240 V AC                 |             |               |        | CT-IRS.35                | 1SVR430221R1400 | 0.161<br>(0.355)          |

<sup>9)</sup> Contacts with gold-plated contacts

# CT-S range

## Ordering details

### Accessories

#### Remote potentiometer

50 k $\Omega$   $\pm$ 20 % - 0,2  $\Omega$ , degree of protection IP66

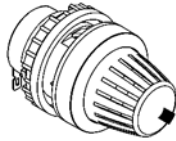

MT-x50B



30 mm adapters

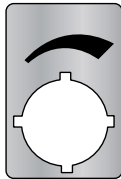

Marker label 29.6 x 44.5 mm

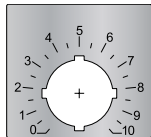

Marker label with scale 0-10  
48.5 x 44.5 mm

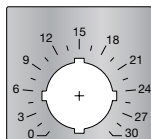

Marker label with scale 0-30  
48.5 x 44.5 mm

| Material        | Diameter | Reference code | Catalog number  | Pack.-unit | Weight |
|-----------------|----------|----------------|-----------------|------------|--------|
|                 | in mm    |                |                 |            |        |
| Plastic, black  | 22.5     | MT-150B        | 1SFA611410R1506 | 1          | 0.040  |
| Plastic, chrome | 22.5     | MT-250B        | 1SFA611410R2506 | 1          | 0.040  |
| Metal, chrome   | 22.5     | MT-350B        | 1SFA611410R3506 | 1          | 0.048  |

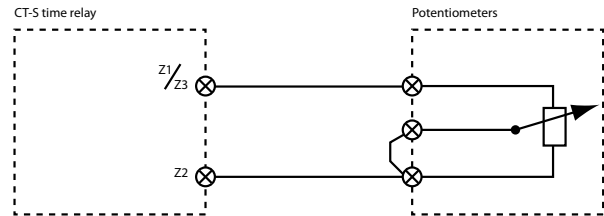
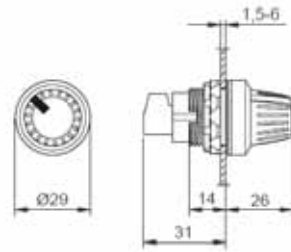

Note: The connections of the potentiometer are not marked.

6

#### 30 mm adapter for attaching the potentiometer 22 mm in 30 mm mounting hole

| Material       | Reference code | Catalog number  | Pack.-unit | Weight  |
|----------------|----------------|-----------------|------------|---------|
|                |                |                 | pieces     | 1 piece |
| Plastic, black | KA1-8029       | 1SFA616920R8029 | 1          | g / oz  |
| Metal, chrome  | KA1-8030       | 1SFA616920R8030 | 1          |         |

#### Marker label

| Caption                   | Reference code | Catalog number  | Pack.-unit | Weight  |
|---------------------------|----------------|-----------------|------------|---------|
|                           |                |                 | pieces     | 1 piece |
| Symbol (see illustration) | SK 615 562-87  | GJD6155620R0087 | 1          | 0.002   |
| Scale 0 - 10              | SK 615 562-88  | GJD6155620R0088 | 1          | 0.002   |
| Scale 0 - 30              | MA16-1060      | 1SFA611940R1060 | 1          | 0.002   |

# CT-S range

## Ordering details

### Accessories

#### Accessories

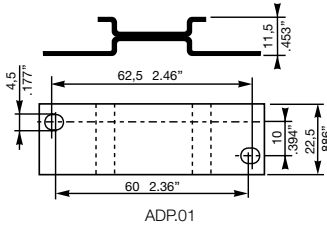

ADP.01

| Material                                 | for devices      | Reference code | Catalog number  | Pack.-unit<br>pieces | Weight<br>1 piece<br>g / oz |
|--|------------------|----------------|-----------------|----------------------|-----------------------------|
| Adapter for screw mounting <sup>1)</sup> | CT-S<br>22.5 mm  | ADP.01         | 1SVR430029R0100 | 1                    | 18.4/0.65                   |
| Sealable transparent cover               |                  | COV.01         | 1SVR430005R0100 | 1                    | 5.2/0.18                    |
| Sealable transparent cover <sup>1)</sup> | CT-S.S/P 22.5 mm | COV.11         | 1SVR730005R0100 | 1                    | 4 / 0.129                   |

#### Marker label

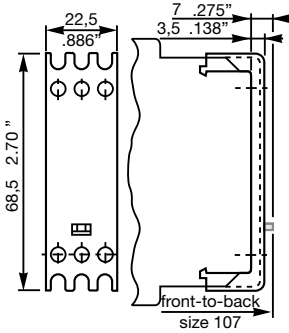

COV.01

| Material | for devices              | Reference code | Catalog number  | Pack.-unit<br>pieces | Weight<br>1 piece<br>g / oz |
|----------|--------------------------|----------------|-----------------|----------------------|-----------------------------|
| Marker   | CT-S without DIP switch  | MAR.01         | 1SVR366017R0100 | 10                   | 0.19/0.007                  |
| Marker   | CT-S with DIP switch     | MAR.02         | 1SVR430043R0000 | 10                   | 0.13/0.005                  |
| Marker   | CT-S.S/P with DIP switch | MAR.12         | 1SVR730006R0000 | 10                   | 0.152/0.335                 |

<sup>1)</sup> also available for CT-S.S/P

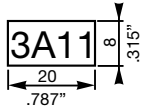

MAR.01

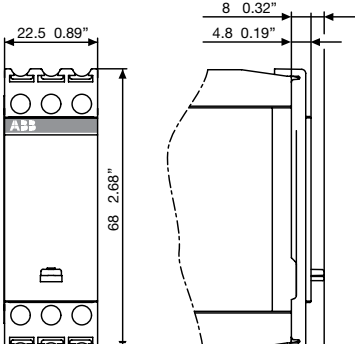

COV.11

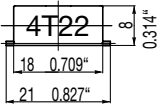

MAR.02

# CT-S range Function diagrams

## Remarks

### Legend

- Control supply voltage not applied / Output contact open
- Control supply voltage applied / Output contact closed

- A1-Y1/B1 Control input with voltage-related triggering
- Y1-Z2 Control input with volt-free triggering
- X1-Z2 Control input with volt-free triggering

### Remote potentiometer connection:

When an external potentiometer is connected to the remote potentiometer connection (terminals **Z1-Z2**, **Z3-Z2** respectively), the internal, front-face potentiometer is disabled and the time adjustment is made via the external potentiometer.

### 2nd c/o contact selectable as instantaneous contact:

When switch position Inst. "I" is selected, the functionality of the 2nd c/o contact changes to an instantaneous contact. It acts like the c/o contacts of a switching relay, i.e. applying or interrupting the control supply voltage energizes or de-energizes the c/o contact. The designation of the 2nd c/o contact changes from **25-26/28** to **21-22/24**, when selected as instantaneous contact.

### Terminal designations on the device and in the diagrams:

The 1st c/o contact is always designated **15-16/18**.  
 The 2nd c/o contact is designated **25-26/28**, if it responds to the time delay.  
 If the 2nd c/o contact is selected as an instantaneous contact, the designation **25-26/28** is replaced by **21-22/24**.  
 Control supply voltage is always applied to terminals **A1-A2**.

### Function of the yellow LEDs:

On devices without the function '2nd c/o contact selectable as instantaneous contact', the yellow LED **R** glows as soon as the output relay energizes and turns off when the output relay de-energizes.

Devices with the function '2nd c/o contact selectable as instantaneous contact' have two yellow LEDs, designated **R1** and **R2**. LED **R1** shows the status of the 1st c/o contact (**15-16/18**) and LED **R2** shows the status of the 2nd c/o contact (**25-26/28**, **21-22/24** resp.). LED **R1** or **R2** glow as soon as the corresponding output relay energizes and turns off when the corresponding output relay de-energizes.

### ⊗ ON-delay (Delay on make) CT-MVS, CT-ERS, CT-WBS

This function requires continuous control supply voltage for timing.  
 Timing begins when control supply voltage is applied. The green LED flashes during timing. When the selected time delay is complete, the output relay energizes and the flashing green LED turns steady.  
 If control supply voltage is interrupted, the output relay de-energizes and the time delay is reset.

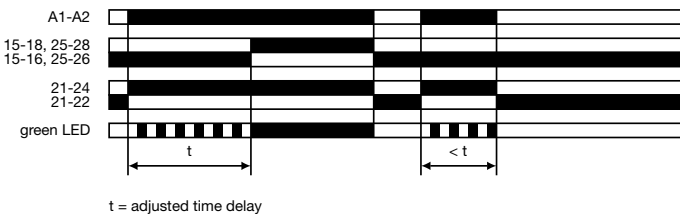

### ⊗ ON-delay (Delay on make) CT-MFS, CT-MBS

This function requires continuous control supply voltage for timing.  
 If control input **Y1-Z2** is open, timing begins when control supply voltage is applied. Or, if control supply voltage is already applied, opening control input **Y1-Z2** also starts timing. The green LED flashes during timing. When the selected time delay is complete, the output relay energizes and the flashing green LED turns steady.  
 If control input **Y1-Z2** closes before the time delay is complete, the time delay is reset and the output relay remains de-energized.  
 Pause timing / Accumulative ON-delay (CT-MFS):  
 Timing can be paused by closing control input **X1-Z2**. The elapsed time  $t_1$  is stored and continues from this time value when **X1-Z2** is re-opened. This can be repeated as often as required.  
 If control supply voltage is interrupted, the output relay de-energizes and the time delay is reset.

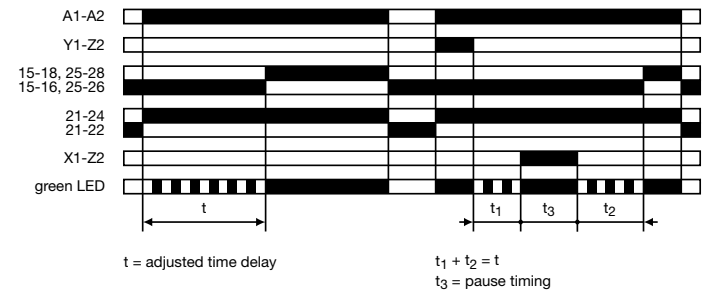

## CT-S range Function diagrams

### ⊞+ Accumulative ON-delay (Accumulative delay on make) CT-MVS

This function requires continuous control supply voltage for timing. Timing begins when control supply voltage is applied. The green LED flashes during timing. When the selected time delay is complete, the output relay energizes and the flashing green LED turns steady.

Timing can be paused by closing control input **A1-Y1/B1**. The elapsed time  $t_1$  is stored and continues from this time value when **A1-Y1/B1** is re-opened.

This can be repeated as often as required.

**6** If control supply voltage is interrupted, the output relay de-energizes and the time delay is reset.

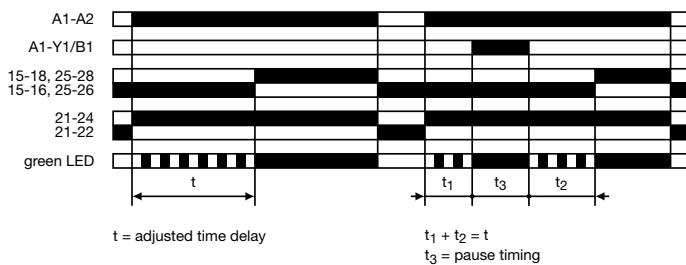

### ■ OFF-delay with auxiliary voltage (Delay on break) CT-MFS, CT-MBS, CT-AHS

This function requires continuous control supply voltage for timing.

If control input **Y1-Z2** is closed, the output relay energizes immediately. If control input **Y1-Z2** is opened, the time delay starts. The green LED flashes during timing. When the selected time delay is complete, the output relay de-energizes and the flashing green LED turns steady.

If control input **Y1-Z2** closes before the time delay is complete, the time delay is reset and the output relay does not change state. Timing starts again when control input **Y1-Z2** re-opens.

Pause timing / Accumulative OFF-delay (CT-MFS):

Timing can be paused by closing control input **X1-Z2**. The elapsed time  $t_1$  is stored and continues from this time value when **X1-Z2** is re-opened.

This can be repeated as often as required.

If control supply voltage is interrupted, the output relay de-energizes and the time delay is reset.

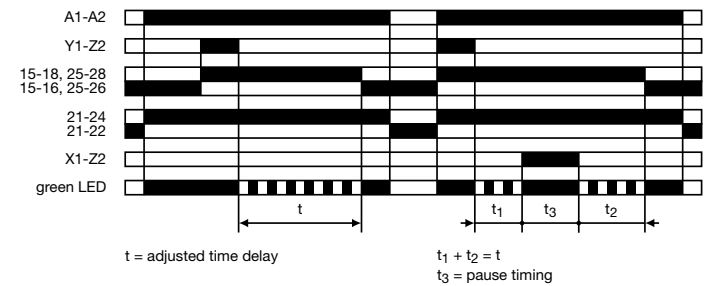

### ■ OFF-delay with auxiliary voltage (Delay on break) CT-MVS, CT-APS

This function requires continuous control supply voltage for timing.

If control input **A1-Y1/B1** is closed, the output relay energizes immediately. If control input **A1-Y1/B1** is opened, the time delay starts. The green LED flashes during timing. When the selected time delay is complete, the output relay de-energizes and the flashing green LED turns steady.

If control input **A1-Y1/B1** recloses before the time delay is complete, the time delay is reset and the output relay does not change state. Timing starts again when control input **A1-Y1/B1** re-opens.

If control supply voltage is interrupted, the output relay de-energizes and the time delay is reset.

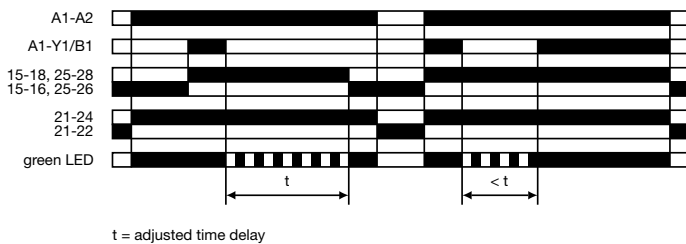

### ■ OFF-delay without auxiliary voltage (True delay on break) CT-ARS

The OFF-delay function without auxiliary voltage does not require continuous control supply voltage for timing. After a storage time of several months without any voltage, a formatting time of about 5 minutes is necessary.

Applying control supply voltage energizes the output relay immediately. Applied control supply voltage is displayed by the glowing green LED. If control supply voltage is interrupted, the OFF-delay starts and the LED turns off. When timing is complete, the output relay de-energizes.

For correct operation of the unit, it is necessary to complete the minimum energizing time. As soon as timing starts, the LED turns off.

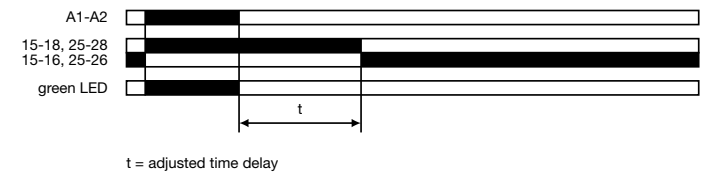



# CT-S range Function diagrams

## OFF-delay without auxiliary voltage for DC contactor coils CT-VBS

The DC contactor coil connected to the output is energized when control supply voltage is applied.  
If control supply voltage is disconnected, the DC contactor coil remains energized for a short time delay. This time delay depends on the coil drop-out voltage and on the wattage of the contactor coil.

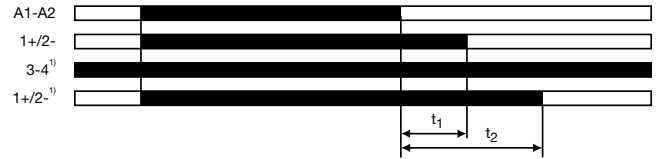

t<sub>1</sub> = OFF-delay (without jumper between terminals 3 and 4 <sup>1)</sup>)  
t<sub>2</sub> = OFF-delay (with jumper between terminals 3 and 4)  
<sup>1)</sup> only for version 200-240 V AC

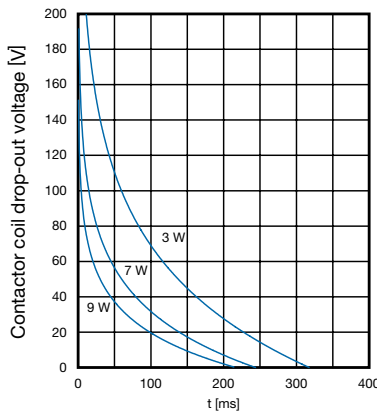

Time delay guideline values  
200-240 V AC version without jumper 3/4

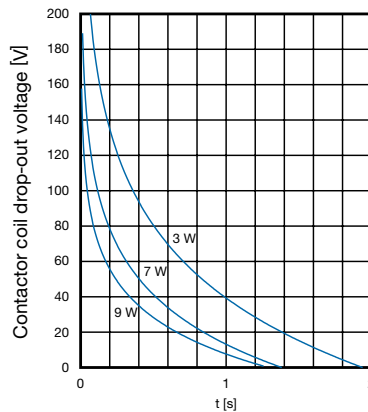

Time delay guideline values  
200-240 V AC version with jumper 3/4

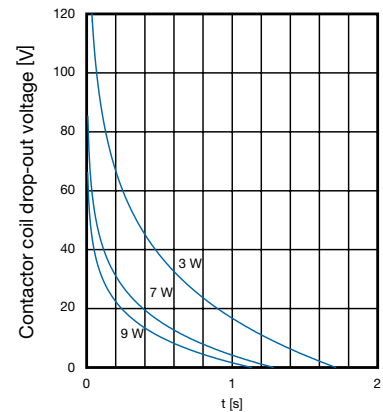

Time delay guideline values  
110-127 V AC version

## Symmetrical ON-delay and OFF-delay (Symmetrical delay on make and delay on break) CT-MFS, CT-MBS

This function requires continuous control supply voltage for timing.  
Closing control input Y1-Z2 starts the ON-delay t<sub>1</sub>. When timing is complete, the output relay energizes. Opening control input Y1-Z2 starts the OFF-delay t<sub>2</sub>. Both timing functions are displayed by the flashing green LED. When the OFF-delay t<sub>2</sub> is complete, the output relay de-energizes.  
If control input Y1-Z2 opens before the ON-delay t<sub>1</sub> is complete, the time delay is reset and the output relay remains de-energized. If control input Y1-Z2 closes before the OFF-delay t<sub>2</sub> is complete, the time delay is reset and the output relay remains energized.  
Pause timing / Accumulative, symmetrical ON-delay and OFF-delay (CT-MFS): Timing can be paused by closing control input X1-Z2. The elapsed time t<sub>1a</sub> or t<sub>2a</sub> is stored and continues from this time value when X1-Z2 is re-opened. This can be repeated as often as required.  
If control supply voltage is interrupted, the output relay de-energizes and the time delay is reset.

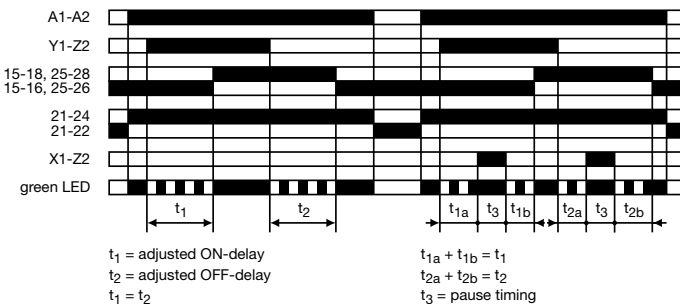

## Symmetrical ON-delay and OFF-delay (Symmetrical delay on make and delay on break) CT-MVS

This function requires continuous control supply voltage for timing.  
Closing control input A1-Y1/B1 starts the ON-delay t<sub>1</sub>. When timing is complete, the output relay energizes. Opening control input A1-Y1/B1 starts the OFF-delay t<sub>2</sub>. Both timing functions are displayed by the flashing green LED. When the OFF-delay t<sub>2</sub> is complete, the output relay de-energizes.  
If control input A1-Y1/B1 opens before the ON-delay t<sub>1</sub> is complete, the time delay is reset and the output relay remains de-energized. If control input A1-Y1/B1 closes before the OFF-delay t<sub>2</sub> is complete, the time delay is reset and the output relay remains energized.  
If control supply voltage is interrupted, the output relay de-energizes and the time delay is reset.

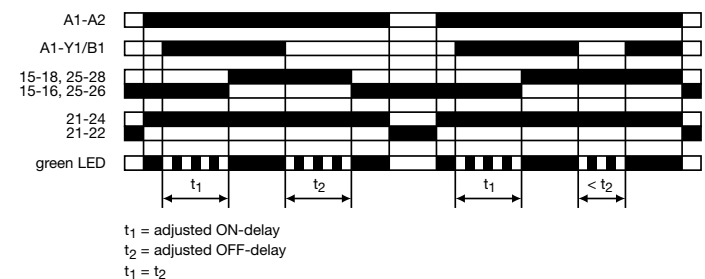

# CT-S range Function diagrams

## Asymmetrical ON-delay and OFF-delay (Asymmetrical delay on make and delay on break) CT-MXS

This function requires continuous control supply voltage for timing.

Closing control input **A1-Y1/B1** starts the ON-delay  $t_1$ . When timing is complete, the output relay energizes. Opening control input **A1-Y1/B1** starts the OFF-delay  $t_2$ . When the OFF-delay is complete, the output relay de-energizes. Both timing functions are displayed by the flashing green LED. The ON-delay and OFF-delay are independently adjustable.

If control input **A1-Y1/B1** opens before the ON-delay is complete ( $<t_1$ ), the time delay is reset and the output relay remains de-energized.

If control input **A1-Y1/B1** closes before the OFF-delay is complete ( $<t_2$ ), the time delay is reset and the output relay remains energized.

If control supply voltage is interrupted, the output relay de-energizes and the time delay is reset.

6

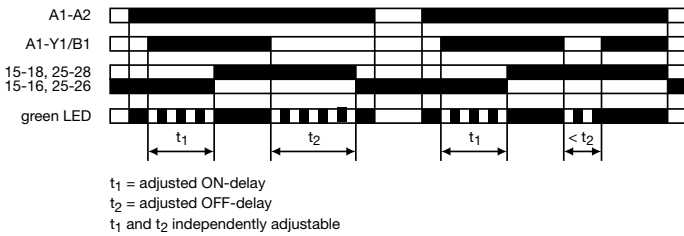

## Impulse-ON (Interval) CT-MVS, CT-WBS

This function requires continuous control supply voltage for timing.

The output relay energizes immediately when control supply voltage is applied and de-energizes after the set pulse time is complete. The green LED flashes during timing. When the selected pulse time is complete, the flashing green LED turns steady.

If control supply voltage is interrupted, the output relay de-energizes and the time delay is reset.

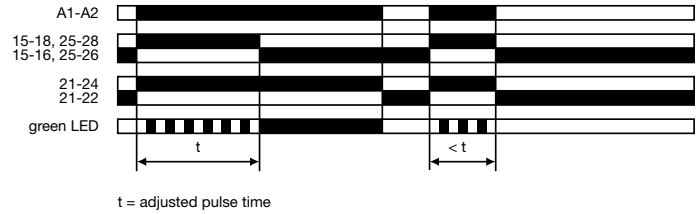

## Impulse-ON (Interval) CT-MFS, CT-MBS

This function requires continuous control supply voltage for timing.

The output relay energizes immediately when control supply voltage is applied and de-energizes after the set pulse time is complete. If control input **Y1-Z2** is open, timing begins when control supply voltage is applied. Or, if control supply voltage is already applied, opening control input **Y1-Z2** starts timing. The green LED flashes during timing. When the selected pulse time is complete, the output relay de-energizes and the flashing green LED turns steady.

Closing control input **Y1-Z2**, before the pulse time is complete, de-energizes the output relay and resets the pulse time.

Pause timing / Accumulative impulse-ON (CT-MFS):  
 Timing can be paused by closing control input **X1-Z2**. The elapsed time  $t_1$  is stored and continues from this time value when **X1-Z2** is re-opened. This can be repeated as often as required.

If control supply voltage is interrupted, the output relay de-energizes and the time delay is reset.

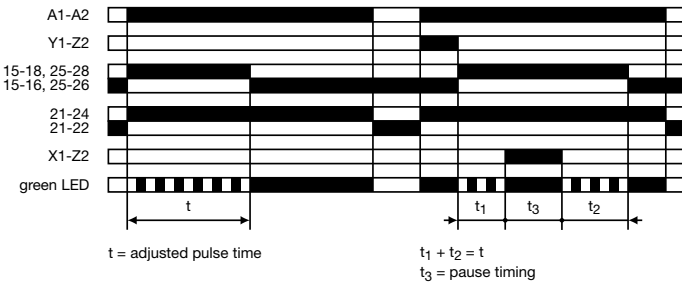

## Impulse-OFF with auxiliary voltage (Trailing edge interval) CT-MFS, CT-MBS

This function requires continuous control supply voltage for timing.

If control supply voltage is applied, opening control input **Y1-Z2** energizes the output relay immediately and starts timing. The green LED flashes during timing. When the selected pulse time is complete, the output relay de-energizes and the flashing green LED turns steady.

Closing control input **Y1-Z2**, before the pulse time is complete, de-energizes the output relay and resets the pulse time.

Pause timing / Accumulative impulse-OFF (CT-MFS):  
 Timing can be paused by closing control input **X1-Z2**. The elapsed time  $t_1$  is stored and continues from this time value when **X1-Z2** is re-opened. This can be repeated as often as required.

If control supply voltage is interrupted, the output relay de-energizes and the time delay is reset.

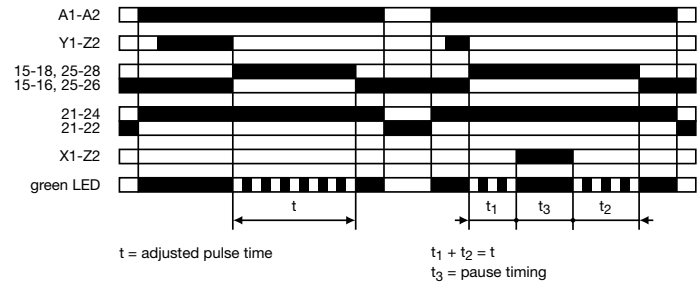

# CT-S range Function diagrams

## Impulse-OFF with auxiliary voltage (Trailing edge interval) CT-MVS

This function requires continuous control supply voltage for timing.  
If control supply voltage is applied, opening control input **A1-Y1/B1** energizes the output relay immediately and starts timing. The green LED flashes during timing. When the selected pulse time is complete, the output relay de-energizes and the flashing green LED turns steady.  
Closing control input **A1-Y1/B1**, before the pulse time is complete, de-energizes the output relay and resets the pulse time.  
If control supply voltage is interrupted, the output relay de-energizes and the time delay is reset.

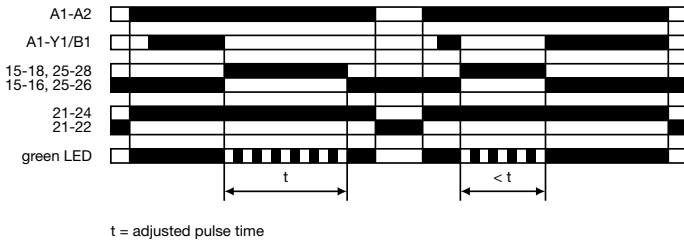

## Impulse-ON and impulse-OFF (Interval and trailing edge interval) CT-MXS

This function requires continuous control supply voltage for timing.  
If control supply voltage is applied, closing control input **A1-Y1/B1** energizes the output relay immediately and starts the pulse time  $t_1$ . The green LED flashes during timing. When  $t_1$  is complete, the output relay de-energizes and the flashing green LED turns steady.  
Re-opening control input **A1-Y1/B1** energizes the output relay immediately and starts the pulse time  $t_2$ . The green LED flashes during timing. When  $t_2$  is complete, the output relay de-energizes and the flashing green LED turns steady.  $t_1$  and  $t_2$  are independently adjustable.  
If control input **A1-Y1/B1** changes state before the pulse time is complete, the output relay de-energizes and the pulse time is reset. If control input **A1-Y1/B1** changes state again, the interrupted pulse time restarts.  
If control supply voltage is interrupted, the output relay de-energizes and the time delay is reset.

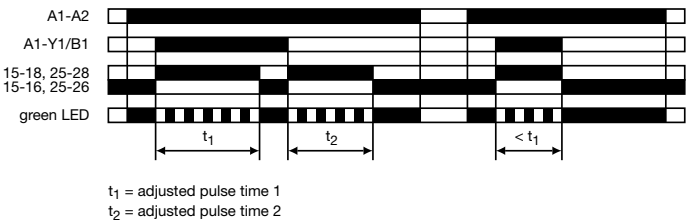

## Flasher, starting with the ON time (Recycling equal times, ON first) CT-WBS

Applying control supply voltage starts timing with symmetrical ON & OFF times. The cycle starts with an ON time first. The ON & OFF times are displayed by the flashing green LED, which flashes twice as fast during the OFF time.  
If control supply voltage is interrupted, the output relay de-energizes and the time delay is reset.

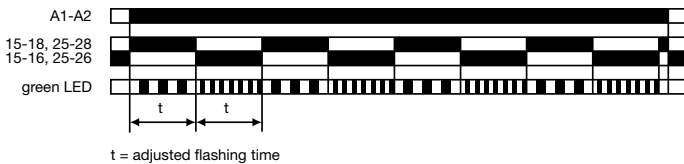

## Flasher, starting with the OFF time (Recycling equal times, OFF first) CT-WBS

Applying control supply voltage starts timing with symmetrical ON & OFF times. The cycle starts with an OFF time first. The ON & OFF times are displayed by the flashing green LED, which flashes twice as fast during the OFF time.  
If control supply voltage is interrupted, the output relay de-energizes and the time delay is reset.

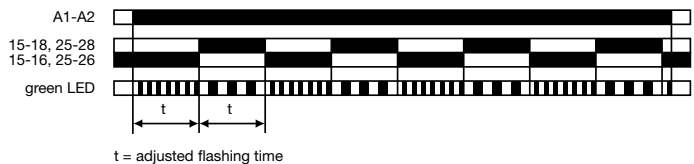

## Flasher with reset, starting with the ON time (Recycling equal times with reset, ON first) CT-MFS, CT-MBS

Applying control supply voltage starts timing with symmetrical ON & OFF times. The cycle starts with an ON time first. The ON & OFF times are displayed by the flashing green LED, which flashes twice as fast during the OFF time.  
The time delay can be reset by closing control input **Y1-Z2**. Opening control input **Y1-Z2** starts the timer pulsing again with symmetrical ON & OFF times.  
If control supply voltage is interrupted, the output relay de-energizes and the time delay is reset.

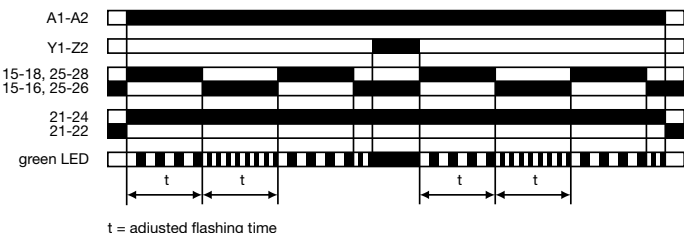

## Flasher with reset, starting with the OFF time (Recycling equal times with reset, OFF first) CT-MFS, CT-MBS

Applying control supply voltage starts timing with symmetrical ON & OFF times. The cycle starts with an OFF time first. The ON & OFF times are displayed by the flashing green LED, which flashes twice as fast during the OFF time.  
The time delay can be reset by closing control input **Y1-Z2**. Opening control input **Y1-Z2** starts the timer pulsing again with symmetrical ON & OFF times.  
If control supply voltage is interrupted, the output relay de-energizes and the time delay is reset.

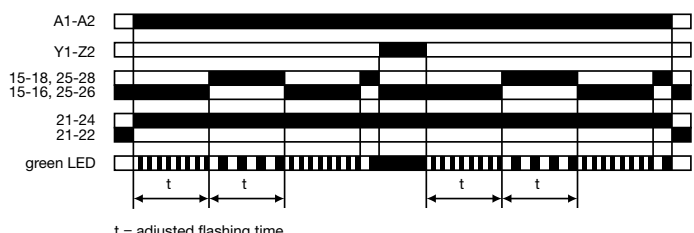

# CT-S range Function diagrams



## Flasher, starting with the ON or OFF time (Recycling equal times, ON or OFF first) CT-MVS

Applying control supply voltage starts timing with symmetrical ON & OFF times. The cycle starts with an ON time first.

Closing control input **A1-Y1/B1**, with control supply voltage applied, starts the cycle with an OFF time first. The ON & OFF times are displayed by the flashing green LED, which flashes twice as fast during the OFF time.

If control supply voltage is interrupted, the output relay de-energizes and the time delay is reset.

6

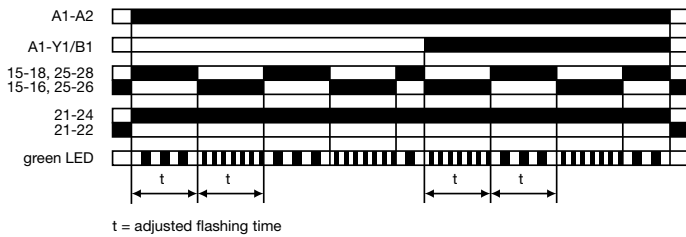

## Pulse former (Single shot) CT-MFS, CT-MBS

This function requires continuous control supply voltage for timing.

Closing control input **Y1-Z2** energizes the output relay immediately and starts timing. Operating the control contact switch **Y1-Z2** during the time delay has no effect. The green LED flashes during timing. When the selected ON time is complete, the output relay de-energizes and the flashing green LED turns steady. After the ON time is complete, it can be restarted by closing control input **Y1-Z2**.

If control supply voltage is interrupted, the output relay de-energizes and the time delay is reset.

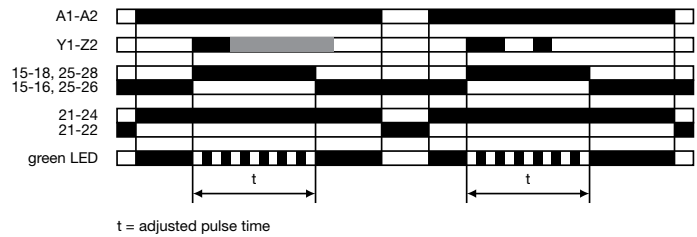

## Pulse former (Single shot) CT-MVS

This function requires continuous control supply voltage for timing.

Closing control input **A1-Y1/B1** energizes the output relay immediately and starts timing. Operating the control contact switch **A1-Y1/B1** during the time delay has no effect. The green LED flashes during timing. When the selected ON time is complete, the output relay de-energizes and the flashing green LED turns steady. After the ON time is complete, it can be restarted by closing control input **A1-Y1/B1**.

If control supply voltage is interrupted, the output relay de-energizes and the time delay is reset.

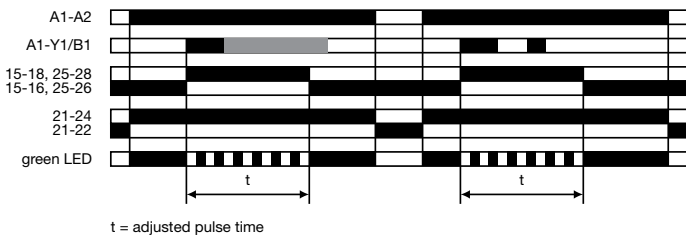

## Pulse generator, starting with the ON or OFF time (Recycling unequal times, ON or OFF first) CT-MXS

This function requires continuous control supply voltage for timing.

Applying control supply voltage, with open control input **A1-Y1/B1**, starts timing with an ON time  $t_2$  first. Applying control supply voltage, with closed control input **A1-Y1/B1**, starts timing with an OFF time  $t_1$  first. The ON & OFF times are displayed by the flashing green LED, which flashes twice as fast during the OFF time. The ON & OFF times are independently adjustable.

If control supply voltage is interrupted, the output relay de-energizes and the time delay is reset.

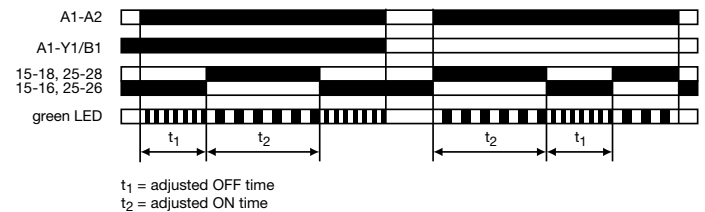

# CT-S range Function diagrams



## Single-pulse generator, starting with the OFF time (Delay on make with interval output) CT-MXS

This function requires continuous control supply voltage for timing. Applying control supply voltage, or, if control supply voltage is already applied, opening control input **A1-Y1/B1** energizes the output relay after the OFF time  $t_1$  is complete. When the following ON time  $t_2$  is complete, the output relay de-energizes. The ON & OFF times are displayed by the flashing green LED, which flashes twice as fast during the OFF time.

The ON & OFF times are independently adjustable. Closing control input **A1-Y1/B1**, with control supply voltage applied, de-energizes the output relay and resets the time delay. If control supply voltage is interrupted, the output relay de-energizes and the time delay is reset.

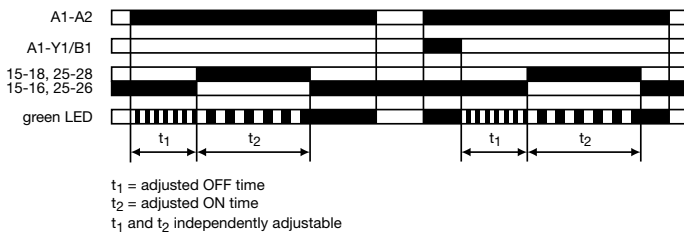

## Fixed impulse with adjustable time delay (Delayed pulse output) CT-WBS

This function requires continuous control supply voltage for timing. The time delay  $t_1$  starts when control supply voltage is applied. The green LED flashes during timing. When  $t_1$  is complete, the output relay energizes for the fixed impulse time  $t_2$  of 500 ms and the flashing green LED turns steady.

If control supply voltage is interrupted, the time delay is reset. The output relay does not change state.

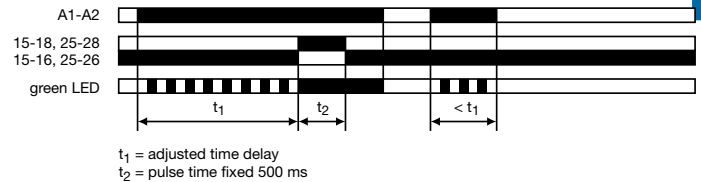

## Adjustable impulse with fixed time delay (Delayed Interval) CT-WBS

This function requires continuous control supply voltage for timing. Applying control supply voltage starts the fixed time delay  $t_2$  of 500 ms. When  $t_2$  is complete, the output relay energizes and the selected pulse time  $t_1$  starts. The green LED flashes during timing. When  $t_1$  is complete, the output relay de-energizes and the flashing green LED turns steady.

If control supply voltage is interrupted, the pulse time is reset. The output relay does not change state.

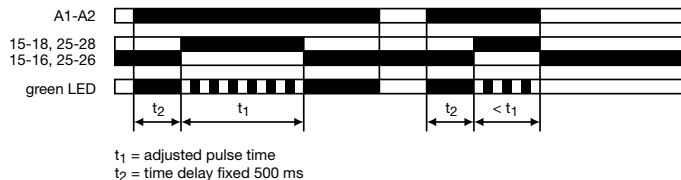

## ON/OFF-Function CT-MFS, CT-MBS, CT-MVS, CT-MXS, CT-WBS

This function is used for test purposes during commissioning and troubleshooting.

If the selected max. value of the time range is smaller than 300 h (front-face potentiometer "Time sector"  $\neq$  300 h), applying control supply voltage energizes the output relay immediately and the green LED glows. Interrupting control supply voltage, de-energizes the output relay.

If the selected max. value of the time range is 300 h (front-face potentiometer "Time sector" = 300 h) and control supply voltage is applied, the green LED glows, but the output relay does not energize.

Time settings and operating of the control inputs have no effect on the operation.

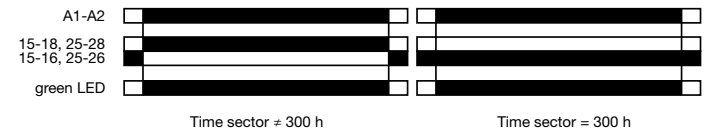

## Switching relays CT-IRS

The switching relay may be used to increase the number of available contacts or to reinforce contacts, or as a coupling/decoupling interface. Approx. 10 ms after applying control supply voltage to terminals **A1-A2**, the output relay energizes.

If control supply voltage is interrupted, the output relay de-energizes.



# CT-S range Function diagrams

## △1□ Star-delta change-over with impulse function (Star-delta starting, interval/delay on make) CT-MFS, CT-MBS, CT-MVS.2x

This function requires continuous control supply voltage for timing.  
Applying control supply voltage to terminals **A1-A2**, energizes the star contactor connected to terminals **15-18** and begins the set starting time  $t_1$ . The green LED flashes during timing. When the starting time is complete, the first c/o contact de-energizes the star contactor.  
Now, the fixed transition time  $t_2$  of 50 ms starts. When the transition time is complete, the second c/o contact energizes the delta contactor connected to terminals **25-28**. The delta contactor remains energized as long as control supply voltage is applied to the unit.

6

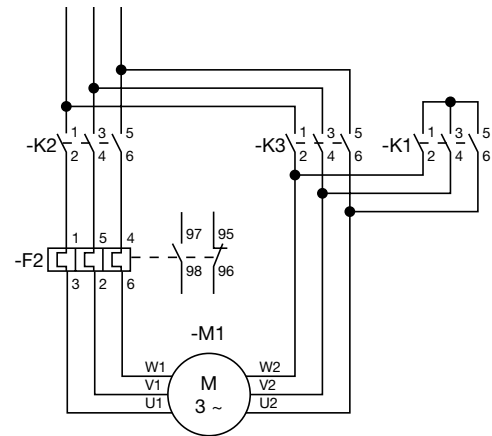
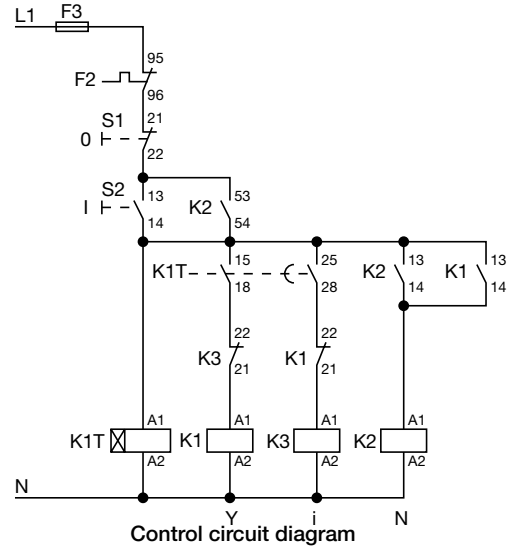
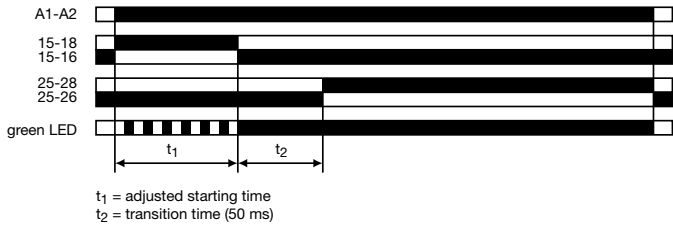

## △ Star-delta change-over (Star-delta starting) CT-SDS

This function requires continuous control supply voltage for timing.  
Applying control supply voltage to terminals **A1-A2**, energizes the star contactor connected to terminals **17-18** and begins the set starting time  $t_1$ . The green LED flashes during timing. When the starting time is complete, the first output contact de-energizes the star contactor.  
Now, the fixed transition time  $t_2$  of 50 ms starts. When the transition time is complete, the second output contact energizes the delta contactor connected to terminals **17-28**. The delta contactor remains energized as long as control supply voltage is applied to the unit.

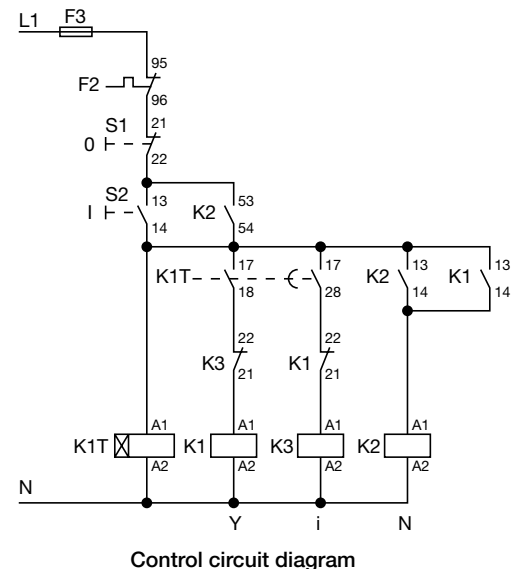
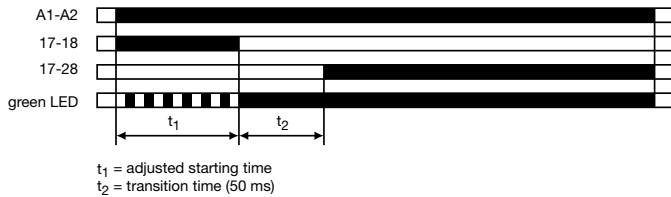

# CT-S range Connection diagrams

**CT-MVS.21**

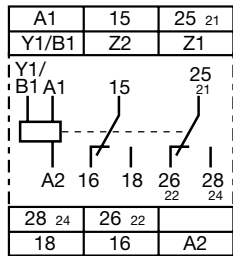

A1-A2 Supply: 24-240 V AC/DC

- 15-16/18 1. c/o contact
- 25-26/28 2. c/o contact
- 21-22/24 2. c/o contact as instantaneous contact
- A1-Y1/B1 Control input
- Z1-Z2 Remote potentiometer connection

**CT-MVS.22**

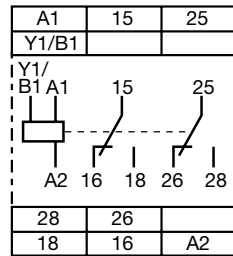

A1-A2 Supply: 24-48 V DC or 24-240 V AC

- 15-16/18 1. c/o contact
- 25-26/28 2. c/o contact
- A1-Y1/B1 Control input

**CT-MVS.23**

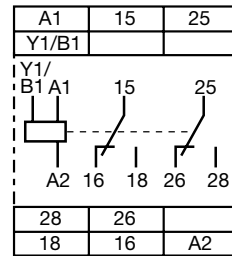

A1-A2 Supply: 380-440 V AC

- 15-16/18 1. c/o contact
- 25-26/28 2. c/o contact
- A1-Y1/B1 Control input

**CT-MVS.12**

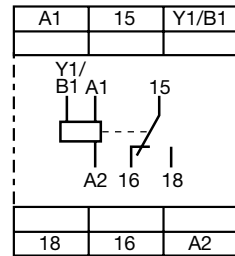

A1-A2 Supply: 24-48 V DC or 24-240 V AC

- 15-16/18 1. c/o contact
- A1-Y1/B1 Control input

**CT-MXS.22**

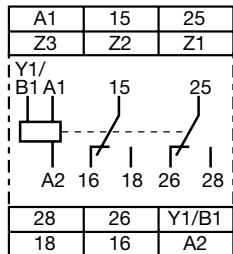

A1-A2 Supply: 24-48 V DC or 24-240 V AC

- 15-16/18 1. c/o contact
- 25-26/28 2. c/o contact
- A1-Y1/B1 Control input
- Z1-Z2 Remote potentiometer connection
- Z3-Z2 Remote potentiometer connection

**CT-MFS.21**

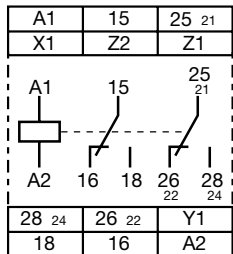

A1-A2 Supply: 24-240 V AC/DC

- 15-16/18 1. c/o contact
- 25-26/28 2. c/o contact
- 21-22/24 2. c/o contact as instantaneous contact
- Y1-Z2 Control input
- X1-Z2 Control input
- Z1-Z2 Remote potentiometer connection

**CT-MBS.22**

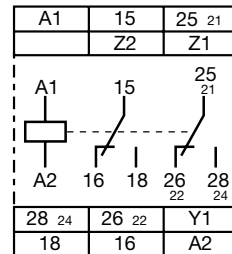

A1-A2 Supply: 24-48 V DC or 24-240 V AC

- 15-16/18 1. c/o contact
- 25-26/28 2. c/o contact
- 21-22/24 2. c/o contact as instantaneous contact
- Y1-Z2 Control input
- Z1-Z2 Remote potentiometer connection

**CT-WBS.22**

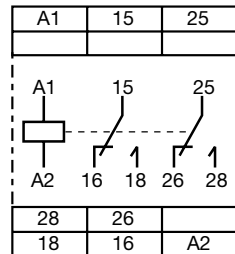

A1-A2 Supply: 24-48 V DC or 24-240 V AC

- 15-16/18 1. c/o contact
- 25-26/28 2. c/o contact

**CT-ERS.21**

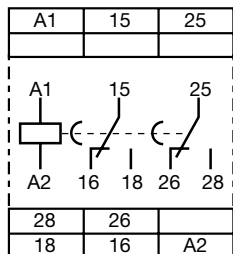

A1-A2 Supply: 24-240 V AC/DC

- 15-16/18 1. c/o contact
- 25-26/28 2. c/o contact

**CT-ERS.22**

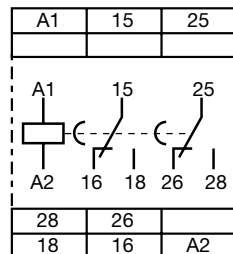

A1-A2 Supply: 24-48 V DC or 24-240 V AC

- 15-16/18 1. c/o contact
- 25-26/28 2. c/o contact

**CT-ERS.12**

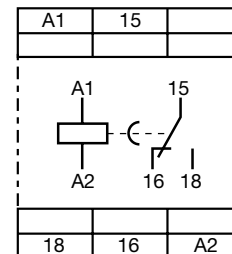

A1-A2 Supply: 24-48 V DC or 24-240 V AC

- 15-16/18 1. c/o contact

# CT-S range Connection diagrams

6

CT-APS.21

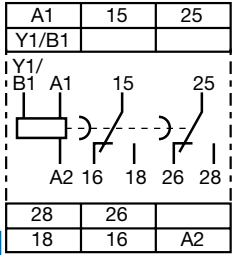

A1-A2 Supply: 24-240 V AC/DC

15-16/18 1. c/o contact  
25-26/28 2. c/o contact

A1-Y1/B1 Control input

CT-APS.22

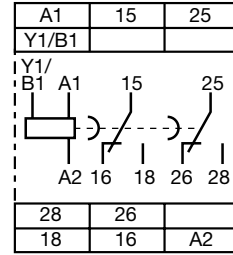

A1-A2 Supply: 24-48 V DC or 24-240 V AC

15-16/18 1. c/o contact  
25-26/28 2. c/o contact

A1-Y1/B1 Control input

CT-APS.12

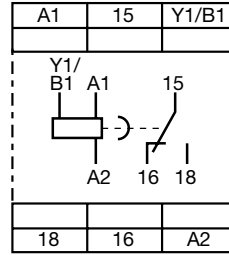

A1-A2 Supply: 24-48 V DC or 24-240 V AC

15-16/18 1. c/o contact

A1-Y1/B1 Control input

CT-AHS.22

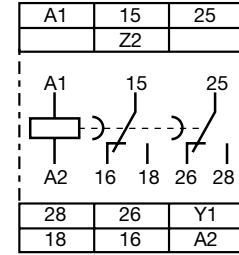

A1-A2 Supply: 24-48 V DC or 24-240 V AC

15-16/18 1. c/o contact  
25-26/28 2. c/o contact

Y1-Z2 Control input

CT-ARS.11

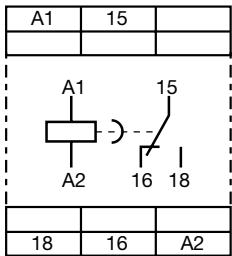

A1-A2 Supply: 24-240 V AC/DC

15-16/18 1. c/o contact

CT-ARS.21

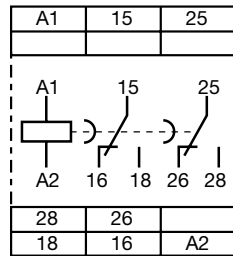

A1-A2 Supply: 24-240 V AC/DC

15-16/18 1. c/o contact  
25-26/28 2. c/o contact

CT-VBS.17

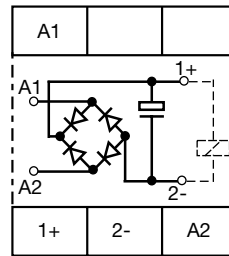

A1-A2 Supply: 110-127 V AC

1+ - 2- Contactor coil

CT-VBS.18

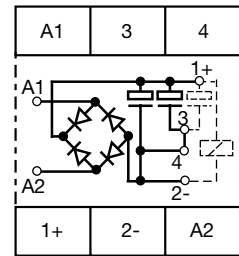

A1-A2 Supply: 200-240 V AC

1+ - 2- Contactor coil  
3-4 Jumper for setting the time delay (see time delay diagram)

CT-SDS.22

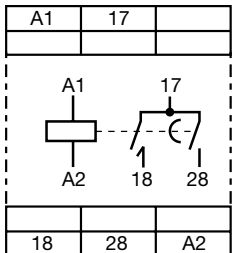

A1-A2 Supply: 24-48 V DC or 24-240 V AC

17-18 1. n/o contact  
17-28 2. n/o contact

CT-SDS.23

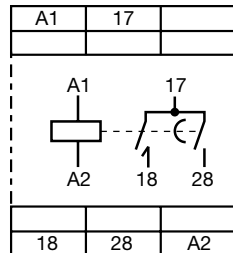

A1-A2 Supply: 380-440 V AC

17-18 1. n/o contact  
17-28 2. n/o contact



# CT-S range Connection diagrams

□ CT-IRS.16

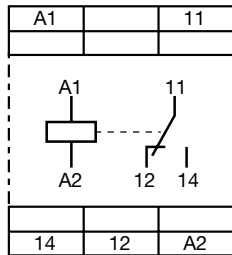

A1-A2 Supply: 24 AC/DC  
11-12/14 1. c/o contact

□ CT-IRS.14

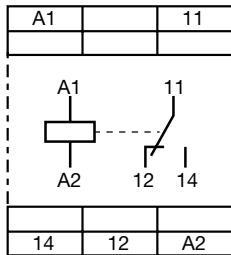

A1-A2 Supply: 110-240 V AC  
11-12/14 1. c/o contact

□ CT-IRS.26

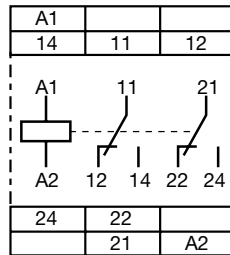

A1-A2 Supply: 24 AC/DC  
11-12/14 1. c/o contact  
21-22/24 2. c/o contact

□ CT-IRS.24

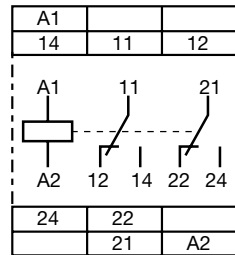

A1-A2 Supply: 110-240 V AC  
11-12/14 1. c/o contact  
21-22/24 2. c/o contact

□ CT-IRS.26G (gold-plated cont.)

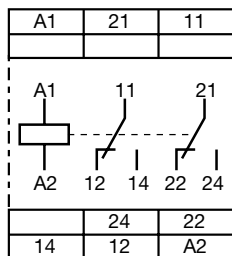

A1-A2 Supply: 24 AC/DC  
11-12/14 1. c/o contact  
21-22/24 2. c/o contact

□ CT-IRS.24G (gold-plated cont.)

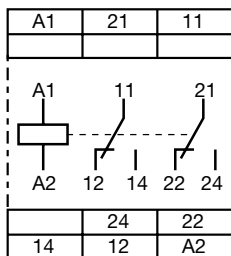

A1-A2 Supply: 110-240 V AC  
11-12/14 1. c/o contact  
21-22/24 2. c/o contact

□ CT-IRS.36

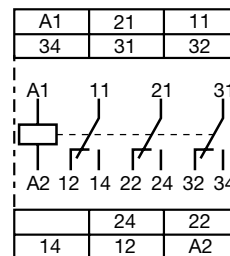

A1-A2 Supply: 24 V AC/DC  
11-12/14 1. c/o contact  
21-22/24 2. c/o contact  
31-32/34 3. c/o contact

□ CT-IRS.35

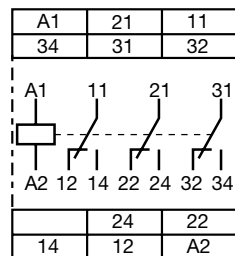

A1-A2 Supply: 220-240 V AC  
11-12/14 1. c/o contact  
21-22/24 2. c/o contact  
31-32/34 3. c/o contact

Data at  $T_a = 25\text{ °C}$  and rated values, unless otherwise indicated

|  |   | CT-S   |
|--|---|--|
| <b>Input circuit - Supply circuit</b>                      |   |  |
| Rated control supply voltage $U_s$                         | CT-xxx.x1   | 24-240 V AC/DC   |
|  | CT-xxx.x2   | 24-48 V DC, 24-240 V AC  |
|  | CT-xxx.x3   | 380-440 V AC   |
|  | CT-xxx.x4   | 110-240 V AC   |
|  | CT-xxx.x5   | 220-240 V AC   |
|  | CT-xxx.x6   | 24 V AC/DC   |
|  | CT-xxx.x7   | 100-127 V AC or 110 V DC   |
|  | CT-xxx.x8   | 200-240V AC/DC   |
| Rated control supply voltage $U_s$ tolerance               |   | -15...+10 %  |
| Rated frequency  |   | DC or 50/60 Hz   |
| Frequency range AC   |   | 47-63 Hz   |
| Typical current / power consumption                        |   | depending on device, see data sheet  |
| Power failure buffering time                               | 24 V DC<br>230/400 V AC   | min. 15 ms<br>min. 20 ms   |
| <b>Input circuit - Control circuit</b>                     |   |  |
| Kind of triggering   | CT-MVS, CT-MXS, CT-APS  | voltage-related triggering   |
| Control input, Control function                            | A1-Y1   | start timing external (CT-MVS, CT-MXS, CT-APS)   |
| Parallel load / polarized                                  |   | yes / no   |
| Maximum cable length to the control input                  |   | 50 m - 100 pF/m  |
| Minimum control pulse length                               |   | 20 ms  |
| Control voltage potential                                  |   | see rated control supply voltage   |
| Current consumption of the control input                   | 24 V DC<br>230 V AC<br>400 V AC   | 1.2 mA<br>8 mA<br>6 mA   |
| Kind of triggering   | CT-MFS, CT-MBS, CT-AHS  | volt-free triggering   |
| Control input, Control function                            | Y1-Z2<br>X1-Z2  | start timing external (CT-MFS, CT-MBS, CT-AHS)<br>pause timing / accumulative functions (CT-MFS)   |
| Maximum switching current in the control circuit           |   | 1 mA   |
| Maximum cable length to the control input                  |   | 50 m - 100 pF/m  |
| Minimum control pulse length                               |   | 20 ms  |
| No-load voltage at the control inputs                      |   | 10-40 V DC   |
| <b>Remote potentiometer</b>                                |   |  |
| Remote potentiometer connections, Resistance value         | Z1-Z2<br>Z3-Z2  | 50 k $\Omega$ (CT-MFS, CT-MBS, CT-MVS.21, CT-MXS)<br>50 k $\Omega$ (CT-MXS)  |
| Maximum cable length to remote potentiometer               |   | 2 x 25 m, shielded with 100 pF/m   |
| Shield connection  |   | Z2   |
| <b>Timing circuit</b>                                      |   |  |
| Time ranges  | 10 time ranges 0.05 s - 300 h<br>7 time ranges 0.05 s - 10 min (CT-SDS, CT-ARS) | 1.) 0.05-1 s 2.) 0.15-3 s 3.) 0.5-10 s 4.) 1.5-30 s 5.) 5-100 s<br>6.) 15-300 s 7.) 1.5-30 min 8.) 15-300 min 9.) 1.5-30 h 10.) 15-300 h<br>1.) 0.05-1 s 2.) 0.15-3 s 3.) 0.5-10 s<br>4.) 1.5-30 s 5.) 5-100 s 6.) 15-300 s 7.) 0.5-10 min |
| Recovery time  | 24-240 V AC/DC<br>24-48 V DC, 24-240 V AC<br>380-440 V AC                       | <50 ms<br>< 80 ms<br>< 60 ms   |
| Accuracy within the rated control supply voltage tolerance |   | $\Delta t < 0.004\%$ / V   |
| Accuracy within the temperature range                      |   | $\Delta t < 0.03\%$ / °C   |
| Repeat accuracy (constant parameters)                      |   | $\Delta t < 0.2\%$   |
| Star-delta transition time                                 |   | fixed 50 ms (CT-SDS, CT-MBS, CT-MFS, CT-MVS.2x)  |
| Star-delta transition time tolerance                       |   | $\pm 2$ ms   |
| Minimum energizing time                                    |   | 100 ms (CT-ARS)  |
| Formatting time <sup>1)</sup>                              |   | 5 min (CT-ARS)   |

<sup>1)</sup> prior to first commissioning and after a six-month stop in operation

# CT-S range

## Technical data

### Indication of operational states

|                                 |                       |   |
|---------------------------------|-----------------------|---|
| Control supply voltage / timing | U/T: green LED        | : control supply voltage applied / : timing |
| Control supply voltage          | U: green LED          | : control supply voltage applied            |
| Relay state                     | R, R1, R2: yellow LED | : output relay energized (R, R1, R2)        |

### Output circuit

|  |   |  |
|--|---|--|
| Kind of output   | 15-16/18  | relay, 1 c/o contact   |
|  | 15-16/18; 25-26/28                                    | relay, 2 c/o contacts  |
|  | 15-16/18; 25(21)-26(22)/28(24)                        | relay, 2 c/o contacts, 2nd c/o contact selectable as inst. contact |
|  | 17-18; 17-28  | relay, 2 n/o contacts (CT-SDS)                                     |
| Contact material   |   | Cd-free, on request  |
| Rated operational voltage $U_g$  | IEC/EN 60947-1  | 250 V  |
| Minimum switching voltage / minimum switching current                      |   | 12 V / 10 mA (CT-IRS.2xG: 10 mV / 10 $\mu$ A)                      |
| Maximum switching voltage / maximum switching current                      |   | see load limit curves (CT-IRS.2xG: 10 V / 200 mA)                  |
| Rated operational current $I_g$<br>(IEC/EN 60947-5-1)                      | AC12 (resistive) at 230 V                             | 4 A  |
|  | AC15 (inductive) at 230 V                             | 3 A  |
|  | AC15 (inductive) at 230 V                             | 4 A  |
|  | DC13 (inductive) at 24 V                              | 2 A (CT-ARS; 1.5 A)  |
| AC rating (UL 508)   | Utilization category<br>(Control Circuit Rating Code) | B 300  |
|  | max. rated operational voltage                        | 300 V AC   |
|  | Maximum continuous thermal current<br>at B300         | 5 A  |
|  | max. making/breaking apparent power<br>at B300        | 3600 VA / 360 VA   |
| Mechanical lifetime  |   | $30 \times 10^6$ switching cycles                                  |
| Electrical lifetime  | at AC12, 230 V, 4 A                                   | $0.1 \times 10^6$ switching cycles                                 |
| Max. fuse rating to achieve short-circuit protection<br>(IEC/EN 60947-5-1) | n/c contact   | 6 A fast-acting  |
|  | n/o contact   | 10 A fast-acting   |

### General data <sup>2)</sup>

|                                 |                       |  |
|---------------------------------|-----------------------|--|
| MTBF                            |                       | on request   |
| Duty time                       |                       | 100%   |
| Dimensions (W x H x D)          | product dimensions    | 22.5 x 85.6 x 103.7 mm (0.89 x 3.37 x 4.08 in)             |
|                                 | packaging dimensions  | 97 x 109 x 30 mm (3.82 x 4.29 x 1.18 in)                   |
| Weight                          |                       | depending on device, see ordering details                  |
| Mounting                        |                       | DIN rail (IEC/EN 60715), snap-on mounting without any tool |
| Mounting position               |                       | any  |
| Minimum distance to other units | vertical / horizontal | not necessary / not necessary                              |
| Material of housing             |                       | UL 94 V-0  |
| Degree of protection            | housing / terminals   | IP50 / IP20  |

### Electrical connection <sup>2)</sup>

|                   | Screw connection technology            | Easy Connect Technology<br>(Push-in)        |
|-------------------|--|---|
| Wire size         | fine-strand with(out) wire end ferrule | 1 x 0.5-2.5 mm <sup>2</sup> (1 x 20-14 AWG) |
|                   |  | 2 x 0.5-1.5 mm <sup>2</sup> (2 x 20-16 AWG) |
|                   | rigid                                  | 1 x 0.5-4 mm <sup>2</sup> (1 x 20-12 AWG)   |
|                   |  | 2 x 0.5-2.5 mm <sup>2</sup> (2 x 20-14 AWG) |
| Stripping length  | 8 mm (0.32 in)                         |   |
| Tightening torque | 0.6-0.8 Nm (5.31-7.08 lb.in)           | -   |

<sup>2)</sup> Data for all references 1SVR 730 xxx xxx and 1SVR 740 xxx xxx. For devices with 1SVR 430 xxx xxx and 1SVR 630 xxx xxx please refer to the data sheet.

## CT-S range

### Technical data

#### Environmental data

|  |                     |   |
|--|---------------------|---|
| Ambient temperature ranges               | operation / storage | -25...+60 °C / -40...+85 °C,<br>-40...+60 °C / -40...+85 °C (CT-MVS.21,<br>CT-MFS.21, CT-ERS.21, CT-APS.21) |
| Damp heat (cyclic) (IEC/EN 60068-2-30)   |                     | 6 x 24 h cycle, 55 °C, 95 % RH  |
| Vibration, sinusoidal (IEC/EN 60068-2-6) | functioning         | 40 m/s <sup>2</sup> , 10-58/60-150 Hz   |
| Vibration, seismic (IEC/EN 60068-3-3)    | resistance          | 60 m/s <sup>2</sup> , 10-58/60-150 Hz, 20 cycles  |
|  | functioning         | 20 m/s <sup>2</sup>   |
| Shock, half-sine (IEC/EN 60068-2-27)     | functioning         | 100 m/s <sup>2</sup> , 11 ms, 3 shocks/direction  |
|  | resistance          | 300 m/s <sup>2</sup> , 11 ms, 3 shocks/direction  |

6

#### Isolation data

|   |                                   |                      |
|---|-----------------------------------|----------------------|
| Rated insulation voltage U <sub>i</sub>   | input circuit / output circuit    | 500 V                |
| Rated impulse withstand voltage U <sub>imp</sub><br>between all isolated circuits         | VDE 0110, IEC/EN 60664            | 4 kV; 1.2/50 µs      |
| Power-frequency withstand voltage test between<br>all isolated circuits (test voltage)    | routine test                      | 2.0 kV, 50Hz, 1 s    |
|   | type test                         | 2.5 kV, 50 Hz, 1 min |
| Basic insulation (IEC/EN 61140)   | input circuit / output circuit    | 500 V                |
| Protective separation (IEC/EN 61140; IEC/EN 50178;<br>VDE 0106 part 101 and part 101/ A1) | input circuit /<br>output circuit | 250 V                |
| Pollution degree (IEC/EN 60664-1, VDE 0110)   |                                   | 3                    |
| Overtoltage category (IEC/EN 60664-1, VDE 110)  |                                   | III                  |

#### Standards

|                       |   |
|-----------------------|---|
| Product standard      | IEC 61812-1, EN 61812-1 + A11, DIN VDE 0435 part 2021 |
| Low Voltage Directive | 2006/95/EC  |
| EMC Directive         | 2004/108/EC   |
| RoHS Directive        | 2002/95/EC  |

#### Electromagnetic compatibility

|  |                                      |  |
|--|--------------------------------------|--|
| Interference immunity to                                     |                                      | IEC/EN 61000-6-1, IEC/EN 61000-6-2                   |
| electronic discharge   | IEC/EN 61000-6-2                     | Level 3 6 kV / 8 kV                                  |
| radiated, radio-frequency<br>electromagnetic field           | IEC/EN 61000-6-3                     | Level 3 10 V/m (1 GHz) 3 V/m (2 GHz) 1 V/m (2.7 GHz) |
| electrical fast transient/burst<br>surge                     | IEC/EN 61000-6-4<br>IEC/EN 61000-6-5 | Level 3 2 kV / 5 kHz<br>Level 4 2 kV A1-A2           |
| conducted disturbances, induced by<br>radio-frequency fields | IEC/EN 61000-6-6                     | Level 3 10 V   |
|  |                                      | Level 3  |
| Interference emissions                                       |                                      | IEC/EN 61000-6-3, IEC/EN 61000-6-4                   |
| high-frequency radiated                                      | IEC/CISPR 22, EN 55022               | Class B  |
| high-frequency conducted                                     | IEC/CISPR 22, EN 55022               | Class B  |

# CT-S range Technical diagrams

## Technical diagrams

### Load limit curves

AC load (resistive)

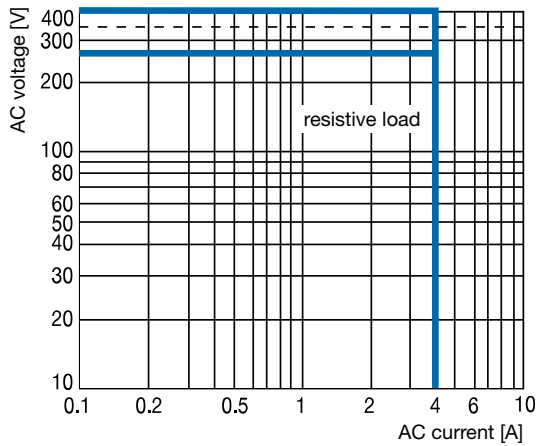

DC load (resistive)

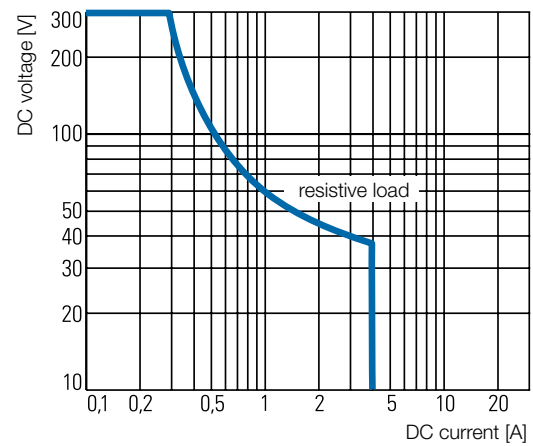

### Derating factor F for inductive AC load

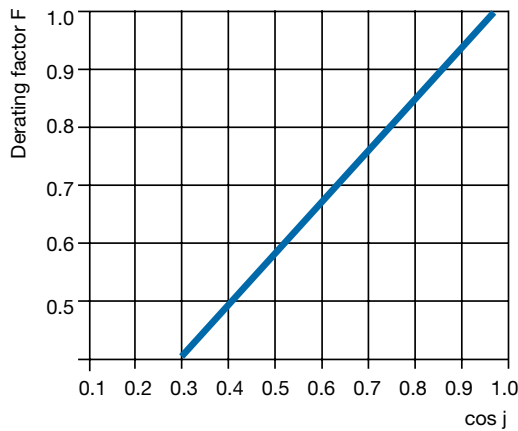

### Contact lifetime

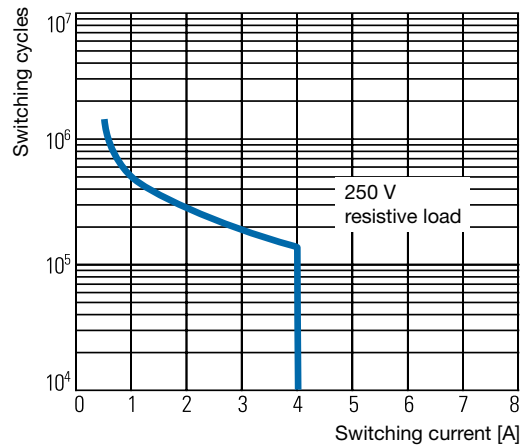

# CT-S range

## Wiring notes

### Approximate dimensions

#### Wiring notes

##### Control inputs (volt-free triggering)

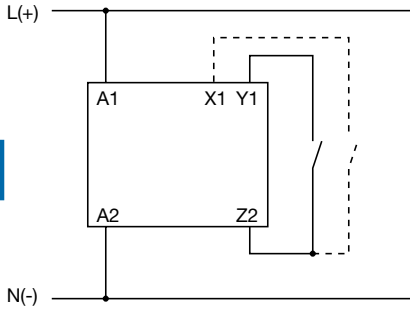

##### Triggering of the control inputs (volt-free) with a proximity switch (3 wire)

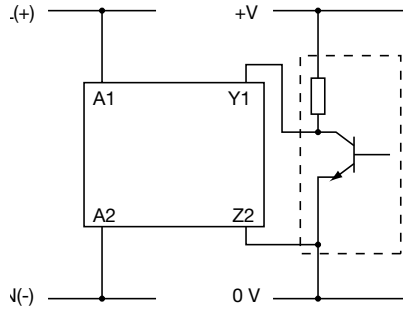

6

##### Control inputs (voltage-related triggering)

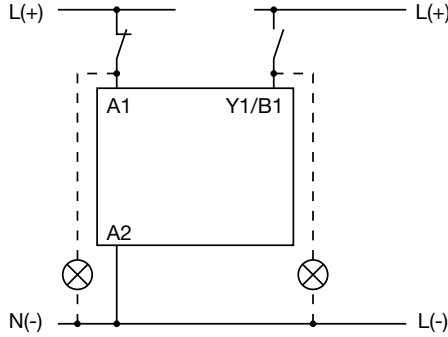
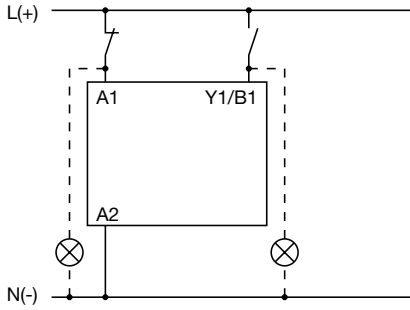

The control input **Y1/B1** is triggered with electric potential against **A2**. It is possible to use the control supply voltage from terminal **A1** or any other voltage within the rated control supply voltage range.

##### Remote potentiometer

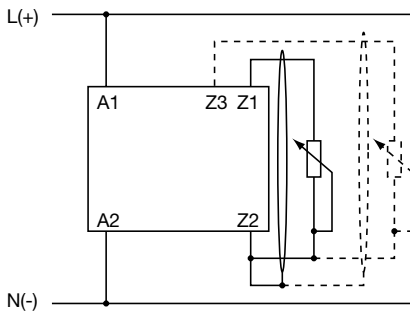

#### Dimensional drawing

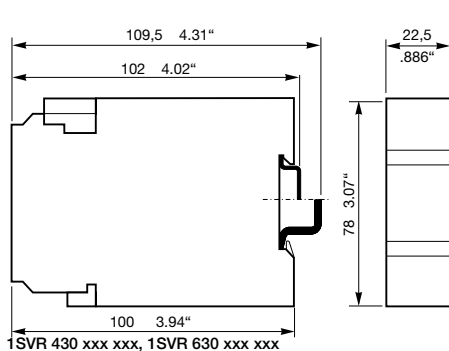

#### Dimensions in mm and inches

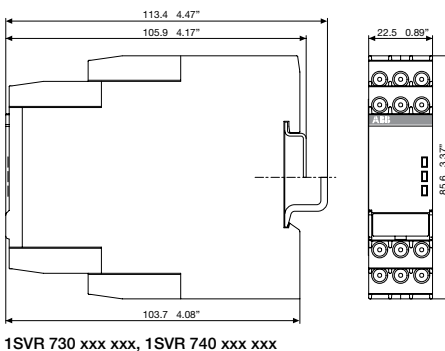

# CM-E Range Measuring & monitoring relays

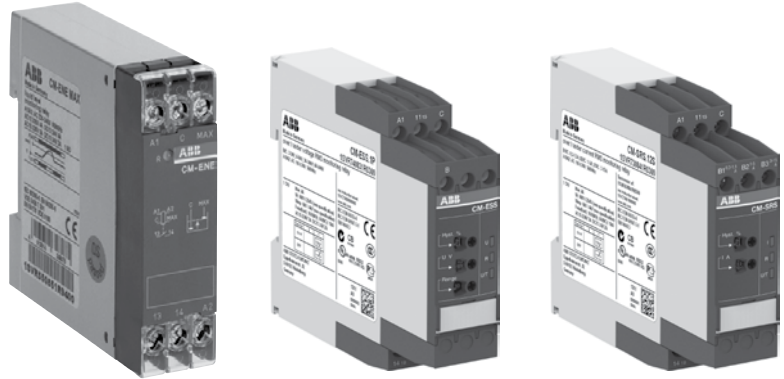

## Measuring and monitoring relays

### Benefits and advantages.

#### Benefits CM-E range



6

- Only 22.5 mm wide housing
- Output contacts: 1 c/o contact or 1 n/o contact
- One supply voltage range
- One monitoring function
- Cost-efficient solution for OEM applications
- Preset monitoring ranges

#### Combination screws ①

Easy tightening and release of the connecting screws with pozidrive, pan- or crosshead screwdriver.

#### Safety ②

The "real distance" is hidden.  
The clearance and the creepage distances of our products exceed international standards and substantially increase the safety of our products.

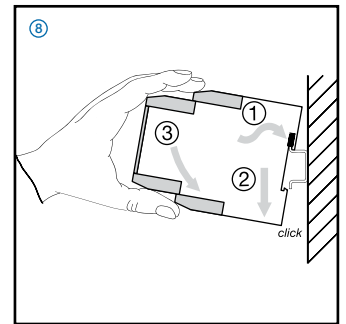
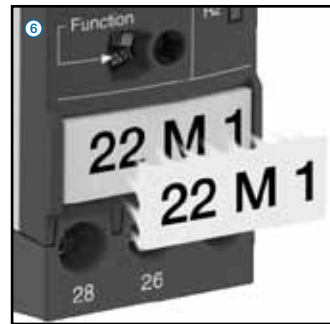
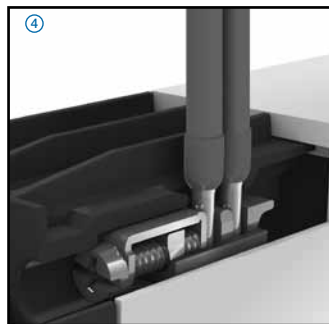
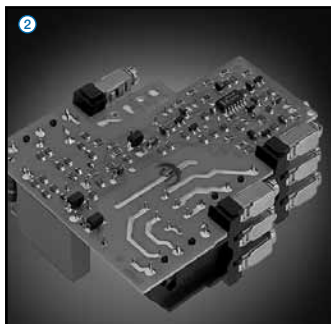
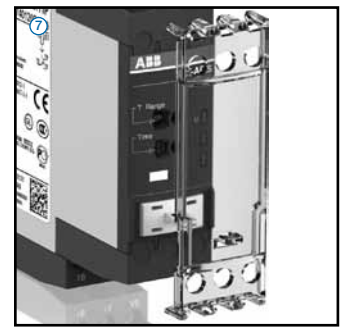
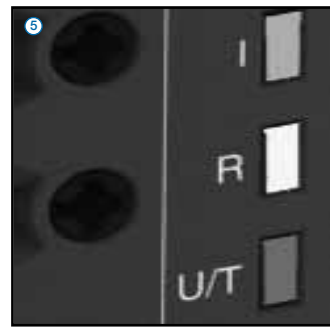
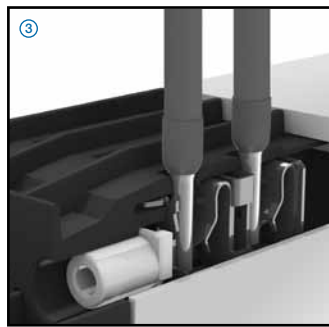
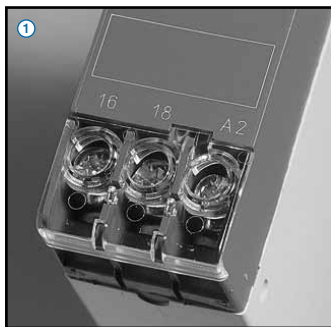

#### CM-S range: Universal and multifunctional



- Only 22.5 mm wide housing
- Output contacts: 1 or 2 c/o (SPDT) contacts
- One supply voltage range or supplied by measuring circuit
- Setting and operation via front-face operating controls
- Adjustment of threshold values and switching hysteresis via direct reading scale
- Integrated and snap-fitted front-face marker
- Snap-on housing: The relays can be placed on a DIN rail tool-free - just snap it on or remove it tool-free
- Sealable transparent cover (accessory)



## Measuring and monitoring relays

### Benefits and advantages.

#### CM-N range: Multifunctional



- 45 mm wide housing
- Output contacts: 2 c/o (SPDT) contacts
- Continuous voltage range (24-240 V AC/DC) or single-supply
- Setting and operation via front-face operating controls
- Adjustment of threshold values and switching hysteresis via direct reading scale
- Adjustable time delays
- Integrated and snap-fitted front-face marker label
- Sealable transparent cover (accessory)

#### ABB's measuring and monitoring relays in a new housing

##### Benefits at a glance

##### Double-chamber cage connection terminals

###### Easy conversions:

The old range of measuring and monitoring relays is replaced by an identical range of relays with Double-chamber cage connection terminals.

The ordering number just changed in one digit:

1SVRx3 ... changed to 1SVR73...

1SVRx5 ... changed to 1SVR75...

and for the type designator we are using one more specifier:

CM-xxS changed to CM-xxS.S

CM-xxN changed to CM-xxN.S

The new range is identically replacing the old range.

###### Ratings:

Double-chamber cage connection terminals provide connection of wires up to 1 x 0.5-4 mm<sup>2</sup> (1 x 20-12 AWG) or 2 x 0.5-2.5 mm<sup>2</sup> (2 x 20-14 AWG) rigid or 1 x 0.5-2.5 mm<sup>2</sup> (1 x 20-14 AWG) / 2 x 0.5-1.5 mm<sup>2</sup> (2 x 20-16 AWG), rigid or fine-strand, with or without wire end ferrules. Potential distribution does not require additional terminals.

###### Extended features

###### Flammability:

The plastic housing material used meets the requirements for the highest flammability class. (UL94 V-O rated)

###### Look and feel:

The new housing fits perfectly with ABB's control products offer.

#### Easy Connect Technology & Double-chamber cage connection terminals

##### Benefits new CM-S range housing

###### Easy Connect Technology ③

Tool-free wiring for excellent vibration resistance. Push-in terminals provide connection of wires up to 2 x 0.5 - 1.5 mm<sup>2</sup>, rigid or fine stranded with or without wire end ferrules.

###### Double-chamber cage connection terminals ④

Double-chamber cage connection terminals provide connection of wires up to 2 x 0.5-2.5 mm<sup>2</sup> (2 x 20-14 AWG) rigid or fine-strand, with or without wire end ferrules. Potential distribution does not require additional terminals.

###### Snap-On housing ⑧

Tool-free DIN rail installation and deinstallation of the monitoring relay with Snap-On housing.

###### LED's for status indication ⑤

All actual operational states are displayed by front-face LED's, thus simplifying commissioning and troubleshooting.

###### Integrated marker label ⑥

Integrated marker labels allow the product to be marked quickly and simply. No additional marker labels are required.

###### Sealable transparent cover ⑦

Protection against unauthorized changes of time and threshold values. Available as an accessory.

##### Easy Connect Technology

###### New options:

Additionally to the existing well established screw connections a new innovative connection technology can be offered: Easy Connect Technology with push-in terminals.

###### Tool-free Wiring:

The push-in terminals can be wired with rigid or fine stranded wires with wire end ferrules totally tool-free. The connection direction is exactly the same as the screw version.

###### Higher utility class:

The Easy Connect Technology provides excellent vibration resistance with gas tight push-in terminals – the right solution for harsh environment.

###### Ratings:

Push-in terminals provide connection of wires up to 2 x 1.5mm<sup>2</sup> (2 x 20-16 AWG), rigid or fine stranded with or without wire end ferrules.

# Measuring and monitoring relays

## Monitoring features and application ranges

6

### Single-phase current and voltage monitoring

- Over- or undercurrent monitoring CM-SRS and CM-SRS.M
- Over- and undercurrent monitoring CM-SFS
- Over- or undervoltage monitoring CM-ESS and CM-ESS.M
- Over- and undervoltage monitoring CM-EFS

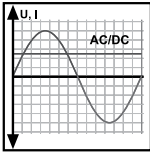

#### Current monitoring

- Monitoring of motor current consumption
- Monitoring of lighting installations and heating circuits
- Monitoring of hoisting gear and transportation equipment overload
- Monitoring of locking devices, electromechanical brake gear and locked rotor

#### Voltage monitoring

- Speed monitoring of DC motors
- Monitoring of battery voltages and other supply networks
- Monitoring of upper and lower voltage threshold values

### Insulation monitoring

- CM-IWS.2 for electrically isolated AC systems, and CM-IWS.1 & CM-IWN 1 for electrically isolated AC, DC and mixed AC/DC systems.
- CM-IWN.5 for solar applications  $\leq 1000 \mu\text{F}$

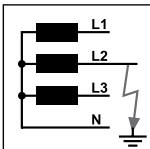

#### Insulation monitoring

- Monitoring of electrically isolated supply mains for insulation resistance failure
- Detection of initial faults
- Protection against earth faults

### Thermistor motor protection

CM-MSE, CM-MSS and CM-MSN provide full protection of motors with integrated PTC resistor sensors.

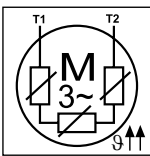

#### Thermistor motor protection

- Protection of motors against thermal overload, e. g. caused by insufficient cooling, heavy load starting conditions, undersized motors, etc.

### Three-phase monitoring

- Phase loss CM-PBE
- Over- and undervoltage CM-PVE
- Phase sequence and phase loss CM-PFE and CM-PFS
- Phase sequence and phase loss, over- and undervoltage CM-PSS.xx and CM-PVS.xx
- Phase sequence and phase loss, unbalance CM-PAS.xx
- Phase sequence and phase loss, unbalance, over- and undervoltage CM-MPS.xx and CM-MPN.xx
- Over- and undervoltage, over- and underfrequency CM-UFS.x

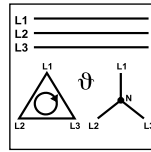

#### Three-phase voltage monitoring

- Voltage monitoring of mobile three-phase equipment
- Protection of personnel and installations against phase reversal
- Monitoring of the supply voltage to machines and installations
- Protection of equipment against damage caused by unstable supply voltage
- Switching to emergency or auxiliary supply
- Protection of motors against damage caused by unbalanced phase voltages and phase loss
- Automatic connection & disconnection of decentralised power stations to the grid

### Motor load monitoring

CM-LWN monitoring relays load states of single- and three-phase asynchronous motors.

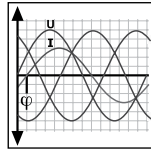

#### Motor load monitoring

- Detection of V-belt breaking
- Motor protection against overload
- Monitoring of filters for clogging
- Protection of pumps against dry running
- Detection of high pressure in conduit systems
- Monitoring for dulling blades in sawing and cutting machines

### Liquid level monitoring

CM-ENE, CM-ENS and CM-ENN for control and regulation of liquid levels and ratios of mixtures of conductive fluids.

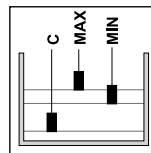

#### Liquid level monitoring and control

- Protection of pumps against dry running
- Protection against container overflow
- Control of liquid levels
- Detection of leaks
- Control of mixing ratios

# Measuring and monitoring relays

## Monitoring features and application ranges

### Contact protection, sensor evaluation

The CM-KRN protects sensitive control contacts from excessive loads and can store switch positions. The CM-SIS supplies and evaluates NPN and PNP sensors.

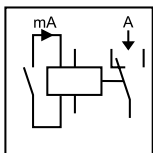

#### Contact protection / sensor evaluation

- Storage of the switching states of bouncing contacts
- Amplification of the switch state information of sensitive contacts
- Supply and evaluation of NPN or PNP sensors

### Cycle monitoring

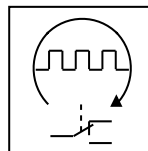

#### Cycle monitoring

- External monitoring of the correct function of programmable logic controllers (plc) and industrial pcs (ipc)

### Temperature monitoring

Acquisition, messaging and regulation of temperatures of solid, liquid and gaseous media in processes and machines via PT100, PT1000, KTY83, KTY 84 or NTC sensors with C510, C511, C512, C513.

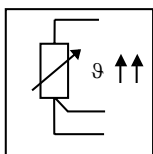

#### Temperature monitoring

- Motor and system protection
- Control panel temperature monitoring
- Frost monitoring
- Temperature limits for process variables, e.g. in the packing or electroplating industry
- Control of systems and machines like heating, air-conditioning and ventilation systems, solar collectors, heat pumps or hot water supply systems
- Monitoring of servomotors with KTY sensors
- Bearing and gear oil monitoring
- Coolant monitoring

# Measuring and monitoring relays

## Monitoring features and application ranges

6

|                  |                             | Current and voltage monitoring, single-phase |           |          |          |           |          |          | Three-phase monitoring |        |        |        |           |           |           |           |           |           |           |           |          |   |
|------------------|-----------------------------|--|-----------|----------|----------|-----------|----------|----------|------------------------|--------|--------|--------|-----------|-----------|-----------|-----------|-----------|-----------|-----------|-----------|----------|---|
|                  |                             | CM-SRS.1x                                    | CM-SRS.2x | CM-SRS.M | CM-SFS.2 | CM-ESS.2x | CM-ESS.M | CM-EFS.2 | CM-PBE                 | CM-PVE | CM-PFE | CM-PFS | CM-PSS.x1 | CM-PVS.x1 | CM-PAS.x1 | CM-MPS.x1 | CM-MPS.x3 | CM-MPN.52 | CM-MPN.62 | CM-MPN.72 | CM-UFS.2 |   |
| <b>Approvals</b> |                             |  |           |          |          |           |          |          |                        |        |        |        |           |           |           |           |           |           |           |           |          |   |
|                  | UL 508, CAN/CSA C22.2 No.14 | ■  | ■         | ■        | ■        | ■         | ■        | ■        | ■                      | ■      | ■      | ■      | ■         | ■         | ■         | ■         | ■         | ■         | ■         | ■         | ■        | ■ |
|                  | GL                          | □  | □         | □        | □        | □         | □        | □        | □                      | □      | □      | □      | □         | □         | □         | □         | □         | □         | □         | □         | □        | □ |
|                  | GOST                        | ■  | ■         | ■        | ■        | ■         | ■        | ■        | ■                      | ■      | ■      | ■      | ■         | ■         | ■         | ■         | ■         | ■         | ■         | ■         | ■        | ■ |
|                  | CB scheme                   | ■  | ■         | ■        | ■        | ■         | ■        | ■        | ■                      | ■      | ■      | ■      | ■         | ■         | ■         | ■         | ■         | ■         | ■         | ■         | ■        | ■ |
|                  | CCC                         | ■  | ■         | ■        | ■        | ■         | ■        | ■        | ■                      | ■      | ■      | ■      | ■         | ■         | ■         | ■         | ■         | ■         | ■         | ■         | ■        | ■ |
|                  | RMRS                        | ■  | ■         | ■        | ■        | ■         | ■        | ■        | ■                      | ■      | ■      | ■      | ■         | ■         | ■         | ■         | ■         | ■         | ■         | ■         | ■        | ■ |
|                  | ENEL DK 5940 Ed. 2.2        |  |           |          |          |           |          |          |                        |        |        |        |           |           |           |           |           |           |           |           |          | ■ |
| <b>Marks</b>     |                             |  |           |          |          |           |          |          |                        |        |        |        |           |           |           |           |           |           |           |           |          |   |
|                  | CE                          | ■  | ■         | ■        | ■        | ■         | ■        | ■        | ■                      | ■      | ■      | ■      | ■         | ■         | ■         | ■         | ■         | ■         | ■         | ■         | ■        | ■ |
|                  | C-Tick                      | ■  | ■         | ■        | ■        | ■         | ■        | ■        | ■                      | ■      | ■      | ■      | ■         | ■         | ■         | ■         | ■         | ■         | ■         | ■         | ■        | ■ |

|                  |                             | Insulation monitoring relays for un-grounded supply mains |          |          |          |        | Motor load monitoring |  |  | Temperature monitoring |      |      | Contact protection, sensor interface |        |   |  |  |  |
|------------------|-----------------------------|---|----------|----------|----------|--------|-----------------------|--|--|------------------------|------|------|--------------------------------------|--------|---|--|--|--|
|                  |                             | CM-IWS.2  | CM-IWS.1 | CM-IWN.1 | CM-IWN.5 | CM-IWN | CM-LWN                |  |  | CM-TCS                 | C512 | C513 | CM-KRN                               | CM-SIS |   |  |  |  |
| <b>Approvals</b> |                             |   |          |          |          |        |                       |  |  |                        |      |      |                                      |        |   |  |  |  |
|                  | UL 508, CAN/CSA C22.2 No.14 | ■   | ■        | ■        | ■        | ■      | ■                     |  |  |                        | ■    | ■    | ■                                    | ■      | ■ |  |  |  |
|                  | GL                          | ■   | ■        | ■        |          | ■      | ■                     |  |  |                        |      |      | ■                                    | ■      |   |  |  |  |
|                  | GOST                        | ■   | ■        | ■        | ■        | ■      | ■                     |  |  |                        |      | ■    | ■                                    |        |   |  |  |  |
|                  | CB scheme                   | ■   | ■        | ■        | □        | ■      | ■                     |  |  |                        |      | ■    | ■                                    |        |   |  |  |  |
|                  | CCC                         | ■   | ■        | ■        | □        | ■      | ■                     |  |  |                        |      | ■    | ■                                    |        |   |  |  |  |
|                  | RMRS                        |   |          |          |          |        | ■                     |  |  |                        |      |      | ■                                    | ■      |   |  |  |  |
| <b>Marks</b>     |                             |   |          |          |          |        |                       |  |  |                        |      |      |                                      |        |   |  |  |  |
|                  | CE                          | ■   | ■        | ■        | ■        | ■      | ■                     |  |  |                        | ■    | ■    | ■                                    | ■      |   |  |  |  |
|                  | C-Tick                      | ■   | ■        | ■        | ■        | ■      | ■                     |  |  |                        | ■    | ■    | ■                                    | ■      |   |  |  |  |

|                  |                              | Cycle monitoring |  | Thermistor motor protection |            |            |            |            |            |            |            | Liquid level monitoring |            |            |        |               |        |               |
|------------------|------------------------------|------------------|--|-----------------------------|------------|------------|------------|------------|------------|------------|------------|-------------------------|------------|------------|--------|---------------|--------|---------------|
|                  |                              | CM-WDS           |  | CM-MSE                      | CM-MSS (1) | CM-MSS (2) | CM-MSS (3) | CM-MSS (4) | CM-MSS (5) | CM-MSS (6) | CM-MSS (7) | CM-MSN                  | CM-ENE MIN | CM-ENE MAX | CM-ENS | CM-ENS UP/... | CM-ENN | CM-ENN UP/... |
| <b>Approvals</b> |                              |                  |  |                             |            |            |            |            |            |            |            |                         |            |            |        |               |        |               |
|                  | UL 508, CAN/CSA C22.2 No.14  | ■                |  | ■                           | ■          | ■          | ■          | ■          | ■          | ■          | ■          | ■                       | ■          | ■          | ■      | ■             | ■      | ■             |
|                  | GL                           |                  |  | ■                           | ■          | ■          | ■          | ■          | ■          | ■          | ■          | ■                       | ■          | ■          | ■      | ■             | ■      | ■             |
|                  | GOST                         | ■                |  | ■                           | ■          | ■          | ■          | ■          | ■          | ■          | ■          | ■                       | ■          | ■          | ■      | ■             | ■      | ■             |
|                  | II (2) G D, PTB 02 ATEX 3080 |                  |  |                             |            |            |            |            |            |            |            |                         |            |            |        |               |        |               |
|                  | CB scheme                    |                  |  | ■                           | ■          | ■          | ■          | ■          | ■          | ■          | ■          | ■                       | ■          | ■          | ■      | ■             | ■      | ■             |
|                  | CCC                          |                  |  | ■                           | ■          | ■          | ■          | ■          | ■          | ■          | ■          | ■                       | ■          | ■          | ■      | ■             | ■      | ■             |
|                  | RMRS                         | ■                |  | ■                           | ■          | ■          | ■          | ■          | ■          | ■          | ■          | ■                       | ■          | ■          | ■      | ■             | ■      | ■             |
| <b>Marks</b>     |                              |                  |  |                             |            |            |            |            |            |            |            |                         |            |            |        |               |        |               |
|                  | CE                           | ■                |  | ■                           | ■          | ■          | ■          | ■          | ■          | ■          | ■          | ■                       | ■          | ■          | ■      | ■             | ■      | ■             |
|                  | C-Tick                       | ■                |  | ■                           | ■          | ■          | ■          | ■          | ■          | ■          | ■          | ■                       | ■          | ■          | ■      | ■             | ■      | ■             |

<sup>1)</sup> Versions with safety isolation without approval

# CM-E Range Current & voltage monitoring relays



Current & voltage monitoring relays  
Single phase



## Current and voltage monitoring relays, single phase

### Benefits and advantages

6



#### Characteristics current monitoring relays

- Monitoring of DC and AC currents: 3 mA to 15 A <sup>1)</sup>
- TRMS measuring principle
- One device includes 3 measuring ranges
- Over- and undercurrent monitoring<sup>1)</sup>
- ON or OFF delay configurable<sup>1)</sup>
- Open- or closed circuit principle configurable<sup>1)</sup>
- Latching function configurable<sup>1)</sup>
- Thresholds for >I and/or <I adjustable<sup>1)</sup>
- Fixed hysteresis of 5 %<sup>1)</sup>
- Start-up delay  $T_v$  adjustable 0; 0.1 - 30 s<sup>1)</sup>
- Tripping delay  $T_v$  adjustable 0; 0.1 - 30 s<sup>1)</sup>
- 1 x 2 c/o contacts (common signal) or 2 x 1 c/o contact (separate signals for >I and <I) configurable<sup>1)</sup>
- 22.5 mm width
- 3 LED's for status indication

<sup>1)</sup> depending on device

#### Current monitoring, single-phase

The ABB current monitoring relays CM-SRS.xx reliably monitor the occurrence of currents that exceed or fall below the selected threshold value. The functions overcurrent or undercurrent monitoring can be pre-selected. Single- and multifunction devices for the monitoring of direct or alternating currents from 3 mA to 15 A are available.

#### Current window monitoring ( $I_{min}$ , $I_{max}$ )

The window monitoring relay CM-SFS.2x is available if the application requires the simultaneous monitoring of over- and undercurrents.

#### Characteristics voltage monitoring relays

- Monitoring of DC and AC voltages from 3 - 600 V
- TRMS measuring principle
- One device includes 4 measuring ranges: 3 - 30 V; 6 - 60 V; 30 - 300 V; 60 - 600 V
- Over- and undervoltage monitoring<sup>1)</sup>
- ON or OFF delay configurable<sup>1)</sup>
- Open- or closed circuit principle configurable<sup>1)</sup>
- Latching function configurable<sup>1)</sup>
- Threshold values for >U and/or <U adjustable<sup>1)</sup>
- Fixed hysteresis of 5 %<sup>1)</sup>
- Start-up delay  $T_v$  adjustable 0; 0.1 - 30 s<sup>1)</sup>
- Tripping delay  $T_v$  adjustable 0; 0.1 - 30 s<sup>1)</sup>
- 1 x 2 c/o contacts (common signal) or 2 x 1 c/o contact (separate signals for >U and <U) configurable<sup>1)</sup>
- 22.5 mm width
- 3 LED's for status indication

#### Voltage monitoring, single-phase

The ABB voltage monitoring relays CM-SRS.xx are used to monitor direct and alternating voltages within a range of 3-600 V. Over- or undervoltage detection can be preselected.

#### Voltage window monitoring ( $U_{min}$ , $U_{max}$ )

For the simultaneous detection of over- and undervoltages, the window monitoring relay CM-EFS.2 can be used.

# Current and voltage monitoring relays, single phase

## Selection and conversion

Measuring & monitoring relays  
CM Range

|  | Reference code | Catalog number  | Predecessor     |
|--|----------------|-----------------|-----------------|
|  | CM-SRS.11S     | 1SVR730840R0200 | 1SVR430840R0200 |
|  | CM-SRS.11P     | 1SVR740840R0200 |                 |
|  | CM-SRS.11S     | 1SVR730841R0200 | 1SVR430841R0200 |
|  | CM-SRS.11P     | 1SVR740841R0200 |                 |
|  | CM-SRS.11S     | 1SVR730841R1200 | 1SVR430841R1200 |
|  | CM-SRS.11P     | 1SVR740841R1200 |                 |
|  |                | 1SVR730840R0300 | 1SVR430840R0300 |
|  | CM-SRS.12S     | 1SVR730841R0300 | 1SVR430841R0300 |
|  |                | 1SVR730841R1300 | 1SVR430841R1300 |
|  | CM-SRS.21S     | 1SVR730840R0400 | 1SVR430840R0400 |
|  | CM-SRS.21P     | 1SVR740840R0400 |                 |
|  |                | 1SVR730841R0400 | 1SVR430841R0400 |
|  | CM-SRS.21S     | 1SVR730841R1400 | 1SVR430841R1400 |
|  | CM-SRS.21P     | 1SVR740841R1400 |                 |
|  |                | 1SVR730840R0500 | 1SVR430840R0500 |
|  | CM-SRS.22S     | 1SVR730841R0500 | 1SVR430841R0500 |
|  |                | 1SVR730841R1500 | 1SVR430841R1500 |
|  | CM-SRS.M1S     | 1SVR730840R0600 | 1SVR430840R0600 |
|  | CM-SRS.M1P     | 1SVR740840R0600 |                 |
|  | CM-SRS.M2S     | 1SVR730840R0700 | 1SVR430840R0700 |
|  | CM-SFS.21S     | 1SVR730760R0400 | 1SVR430760R0400 |
|  | CM-SFS.21P     | 1SVR740760R0400 |                 |
|  | CM-SFS.22S     | 1SVR730760R0500 | 1SVR430760R0500 |

| Rated control supply voltage U <sub>c</sub> | 1 | 2 | 3 | 4 | 5 | 6 | 7 | 8 | 9 | 10 | 11 | 12 | 13 | 14 | 15 | 16 | 17 | 18 | 19 | 20 | 21 | 22 | 23 | 24 |  |
|---|---|---|---|---|---|---|---|---|---|----|----|----|----|----|----|----|----|----|----|----|----|----|----|----|--|
| 24 - 240 V AC/DC                            | ■ | ■ |   |   |   |   |   |   |   |    |    |    |    |    |    |    |    |    |    |    |    |    |    |    |  |
| 110 - 130 V AC                              |   |   | ■ | ■ |   |   |   |   |   |    |    |    |    |    |    |    |    |    |    |    |    |    |    |    |  |
| 220 - 240 V AC                              |   |   |   |   | ■ | ■ |   |   |   |    |    |    |    |    |    |    |    |    |    |    |    |    |    |    |  |

| Measuring ranges AC/DC | 1 | 2 | 3 | 4 | 5 | 6 | 7 | 8 | 9 | 10 | 11 | 12 | 13 | 14 | 15 | 16 | 17 | 18 | 19 | 20 | 21 | 22 | 23 | 24 |   |
|------------------------|---|---|---|---|---|---|---|---|---|----|----|----|----|----|----|----|----|----|----|----|----|----|----|----|---|
| 3 - 30 mA              | ■ | ■ | ■ | ■ | ■ | ■ |   |   |   |    |    |    |    |    |    |    |    |    |    |    |    |    |    |    |   |
| 10 - 100 mA            |   | ■ | ■ | ■ | ■ | ■ | ■ | ■ | ■ | ■  | ■  | ■  | ■  | ■  | ■  | ■  | ■  | ■  | ■  | ■  | ■  | ■  | ■  | ■  | ■ |
| 0.1 - 1 A              | ■ | ■ | ■ | ■ | ■ | ■ |   |   |   |    |    |    |    |    |    |    |    |    |    |    |    |    |    |    |   |
| 0.3 - 1.5 A            |   |   |   |   |   |   | ■ | ■ | ■ | ■  | ■  | ■  | ■  | ■  | ■  | ■  | ■  | ■  | ■  | ■  | ■  | ■  | ■  | ■  | ■ |
| 1 - 5 A                |   |   |   |   |   |   | ■ | ■ | ■ | ■  | ■  | ■  | ■  | ■  | ■  | ■  | ■  | ■  | ■  | ■  | ■  | ■  | ■  | ■  | ■ |
| 3 - 15 A               |   |   |   |   |   |   | ■ | ■ | ■ | ■  | ■  | ■  | ■  | ■  | ■  | ■  | ■  | ■  | ■  | ■  | ■  | ■  | ■  | ■  | ■ |

| Monitoring function                      | 1 | 2 | 3 | 4 | 5 | 6 | 7 | 8 | 9 | 10 | 11 | 12 | 13 | 14 | 15 | 16 | 17 | 18 | 19 | 20 | 21 | 22  | 23  | 24  |     |
|--|---|---|---|---|---|---|---|---|---|----|----|----|----|----|----|----|----|----|----|----|----|-----|-----|-----|-----|
| Over- or undercurrent                    | ■ | ■ | ■ | ■ | ■ | ■ | ■ | ■ | ■ | ■  | ■  | ■  | ■  | ■  | ■  | ■  | ■  | ■  | ■  | ■  | ■  | ■   | ■   | ■   | ■   |
| Windows current monitoring               |   |   |   |   |   |   |   |   |   |    |    |    |    |    |    |    |    |    |    |    |    |     | ■   | ■   | ■   |
| Latching                                 |   |   |   |   |   |   |   |   |   |    |    |    |    |    |    |    |    |    |    |    |    | sel | sel | sel | sel |
| Open circuit or closed circuit principle |   |   |   |   |   |   |   |   |   |    |    |    |    |    |    |    |    |    |    |    |    | sel | sel | sel | sel |

| Timing functions for tripping delay | 1 | 2 | 3 | 4 | 5 | 6 | 7 | 8 | 9 | 10 | 11 | 12 | 13 | 14 | 15 | 16 | 17 | 18 | 19 | 20 | 21 | 22 | 23 | 24 |  |
|-------------------------------------|---|---|---|---|---|---|---|---|---|----|----|----|----|----|----|----|----|----|----|----|----|----|----|----|--|
| ON delay, 0 or 0,1 - 30 s           |   |   |   |   |   |   |   |   |   |    |    |    |    |    |    |    |    |    |    |    |    |    |    |    |  |
| ON or OFF delay                     |   |   |   |   |   |   |   |   |   |    |    |    |    |    |    |    |    |    |    |    |    |    |    |    |  |

| Output      | 1 | 2 | 3 | 4 | 5 | 6 | 7 | 8 | 9 | 10 | 11 | 12 | 13 | 14 | 15 | 16 | 17 | 18 | 19 | 20 | 21 | 22 | 23 | 24 |
|-------------|---|---|---|---|---|---|---|---|---|----|----|----|----|----|----|----|----|----|----|----|----|----|----|----|
| c/o contact | 1 | 1 | 1 | 1 | 1 | 1 | 1 | 1 | 1 | 1  | 1  | 1  | 1  | 1  | 1  | 1  | 1  | 1  | 1  | 1  | 2  | 2  | 2  | 2  |

| Connection type                          | 1 | 2 | 3 | 4 | 5 | 6 | 7 | 8 | 9 | 10 | 11 | 12 | 13 | 14 | 15 | 16 | 17 | 18 | 19 | 20 | 21 | 22 | 23 | 24 |
|--|---|---|---|---|---|---|---|---|---|----|----|----|----|----|----|----|----|----|----|----|----|----|----|----|
| Easy Connect Technology                  |   | ■ |   | ■ |   | ■ |   |   |   |    | ■  |    | ■  |    | ■  |    |    |    |    |    | ■  |    |    | ■  |
| Double-chamber cage connection terminals | ■ |   | ■ |   | ■ |   | ■ |   | ■ |    | ■  |    | ■  |    | ■  |    | ■  |    | ■  |    | ■  |    | ■  | ■  |

# Current and voltage monitoring relays, single phase

## Selection and conversion

6

| Reference code | Catalog number  | Predecessor     |
|----------------|-----------------|-----------------|
| CM-ESS.1S      | 1SVR730831R0300 | 1SVR430831R0300 |
| CM-ESS.1P      | 1SVR740831R0300 |                 |
| CM-ESS.1S      | 1SVR730831R0300 | 1SVR430831R0300 |
| CM-ESS.1P      | 1SVR740831R0300 |                 |
| CM-ESS.1S      | 1SVR730831R1300 | 1SVR430831R1300 |
| CM-ESS.1P      | 1SVR740831R1300 |                 |
| CM-ESS.2S      | 1SVR730830R0400 | 1SVR430830R0400 |
| CM-ESS.2P      | 1SVR740830R0400 |                 |
| CM-ESS.2S      | 1SVR730831R0400 | 1SVR430831R0400 |
| CM-ESS.2P      | 1SVR740831R0400 |                 |
| CM-ESS.2S      | 1SVR730831R1400 | 1SVR430831R1400 |
| CM-ESS.2P      | 1SVR740831R1400 |                 |
| CM-ESS.MS      | 1SVR730830R0500 | 1SVR430830R0500 |
| CM-ESS.MP      | 1SVR740830R0500 |                 |
| CM-EFS.2S      | 1SVR730750R0400 | 1SVR430750R0400 |
| CM-EFS.2P      | 1SVR740750R0400 |                 |

| Rated control supply voltage U <sub>s</sub> | CM-ESS.1S | CM-ESS.1P | CM-ESS.1S | CM-ESS.1P | CM-ESS.1S | CM-ESS.1P | CM-ESS.2S | CM-ESS.2P | CM-ESS.2S | CM-ESS.2P | CM-ESS.2S | CM-ESS.2P | CM-ESS.MS | CM-ESS.MP | CM-EFS.2S | CM-EFS.2P |
|---|-----------|-----------|-----------|-----------|-----------|-----------|-----------|-----------|-----------|-----------|-----------|-----------|-----------|-----------|-----------|-----------|
| 24 - 240 V AC/DC                            | ■         | ■         |           |           |           |           | ■         | ■         |           |           |           |           | ■         | ■         | ■         | ■         |
| 110 - 130 V AC                              |           |           | ■         | ■         |           |           |           |           | ■         | ■         |           |           |           |           |           |           |
| 220 - 240 V AC                              |           |           |           |           | ■         | ■         |           |           |           |           | ■         | ■         |           |           |           |           |

| Measuring ranges AC/DC | CM-ESS.1S | CM-ESS.1P | CM-ESS.1S | CM-ESS.1P | CM-ESS.1S | CM-ESS.1P | CM-ESS.2S | CM-ESS.2P | CM-ESS.2S | CM-ESS.2P | CM-ESS.2S | CM-ESS.2P | CM-ESS.MS | CM-ESS.MP | CM-EFS.2S | CM-EFS.2P |
|------------------------|-----------|-----------|-----------|-----------|-----------|-----------|-----------|-----------|-----------|-----------|-----------|-----------|-----------|-----------|-----------|-----------|
| 3 - 30 V               | ■         | ■         | ■         | ■         | ■         | ■         | ■         | ■         | ■         | ■         | ■         | ■         | ■         | ■         | ■         | ■         |
| 6 - 60 V               | ■         | ■         | ■         | ■         | ■         | ■         | ■         | ■         | ■         | ■         | ■         | ■         | ■         | ■         | ■         | ■         |
| 30 - 300 V             | ■         | ■         | ■         | ■         | ■         | ■         | ■         | ■         | ■         | ■         | ■         | ■         | ■         | ■         | ■         | ■         |
| 60 - 600 V             | ■         | ■         | ■         | ■         | ■         | ■         | ■         | ■         | ■         | ■         | ■         | ■         | ■         | ■         | ■         | ■         |

| Monitoring function                      | CM-ESS.1S | CM-ESS.1P | CM-ESS.1S | CM-ESS.1P | CM-ESS.1S | CM-ESS.1P | CM-ESS.2S | CM-ESS.2P | CM-ESS.2S | CM-ESS.2P | CM-ESS.2S | CM-ESS.2P | CM-ESS.MS | CM-ESS.MP | CM-EFS.2S | CM-EFS.2P |
|--|-----------|-----------|-----------|-----------|-----------|-----------|-----------|-----------|-----------|-----------|-----------|-----------|-----------|-----------|-----------|-----------|
| Over- or undervoltage                    | ■         | ■         | ■         | ■         | ■         | ■         | ■         | ■         | ■         | ■         | ■         | ■         | ■         | ■         |           |           |
| Windows voltage monitoring               |           |           |           |           |           |           |           |           |           |           |           |           |           |           | ■         | ■         |
| Latching                                 |           |           |           |           |           |           |           |           |           |           |           |           | sel       | sel       | sel       | sel       |
| Open circuit or closed circuit principle |           |           |           |           |           |           |           |           |           |           |           |           | sel       | sel       | sel       | sel       |

| Timing functions for tripping delay | CM-ESS.1S | CM-ESS.1P | CM-ESS.1S | CM-ESS.1P | CM-ESS.1S | CM-ESS.1P | CM-ESS.2S | CM-ESS.2P | CM-ESS.2S | CM-ESS.2P | CM-ESS.2S | CM-ESS.2P | CM-ESS.MS | CM-ESS.MP | CM-EFS.2S | CM-EFS.2P |
|-------------------------------------|-----------|-----------|-----------|-----------|-----------|-----------|-----------|-----------|-----------|-----------|-----------|-----------|-----------|-----------|-----------|-----------|
| ON delay, 0 or 0,1 - 30 s           |           |           |           |           |           |           | adj       | adj       | adj       | adj       | adj       | adj       | adj       | adj       |           |           |
| ON or OFF delay                     |           |           |           |           |           |           |           |           |           |           |           |           |           |           | sel       | sel       |

| Output      | CM-ESS.1S | CM-ESS.1P | CM-ESS.1S | CM-ESS.1P | CM-ESS.1S | CM-ESS.1P | CM-ESS.2S | CM-ESS.2P | CM-ESS.2S | CM-ESS.2P | CM-ESS.2S | CM-ESS.2P | CM-ESS.MS | CM-ESS.MP | CM-EFS.2S | CM-EFS.2P |
|-------------|-----------|-----------|-----------|-----------|-----------|-----------|-----------|-----------|-----------|-----------|-----------|-----------|-----------|-----------|-----------|-----------|
| c/o contact | 1         | 1         | 1         | 1         | 1         | 1         | 2         | 2         | 2         | 2         | 2         | 2         | 2         | 2         | 2         | 2         |

| Connection type                          | CM-ESS.1S | CM-ESS.1P | CM-ESS.1S | CM-ESS.1P | CM-ESS.1S | CM-ESS.1P | CM-ESS.2S | CM-ESS.2P | CM-ESS.2S | CM-ESS.2P | CM-ESS.2S | CM-ESS.2P | CM-ESS.MS | CM-ESS.MP | CM-EFS.2S | CM-EFS.2P |
|--|-----------|-----------|-----------|-----------|-----------|-----------|-----------|-----------|-----------|-----------|-----------|-----------|-----------|-----------|-----------|-----------|
| Easy Connect Technology                  |           | ■         |           | ■         |           | ■         |           | ■         |           | ■         |           | ■         |           | ■         |           | ■         |
| Double-chamber cage connection terminals | ■         |           | ■         |           | ■         |           | ■         |           | ■         |           | ■         |           | ■         |           | ■         |           |



# Current and voltage monitoring relays, single phase

## Ordering details

### Current monitors



CM-SRS.22S



CM-SFS.22P

### Description

Single phase voltage and current monitors protect sensitive equipment and control systems against undervoltage, undercurrent events, overvoltage or overcurrent events. Different units with adjustable or fixed threshold values (trip points) are available.

### Ordering details

| Rated control supply voltage | Tripping delay $T_v$        | Measuring range                 | Reference code | Catalog number  | Weight (1 pce)<br>kg (lb) |
|------------------------------|-----------------------------|---------------------------------|----------------|-----------------|---------------------------|
| 24-240 V AC/DC               | without                     | 3-30 mA<br>10-100 mA<br>0.1-1 A | CM-SRS.11S     | 1SVR730840R0200 | 0.145 (0.320)             |
| 110-130 V AC                 |                             |                                 |                | 1SVR730841R0200 | 0.161 (0.355)             |
| 220-240 V AC                 |                             |                                 |                | 1SVR730841R1200 | 0.161 (0.355)             |
| 24-240 V AC/DC               |                             |                                 | CM-SRS.11P     | 1SVR740840R0200 | 0.137 (0.302)             |
| 110-130 V AC                 |                             |                                 |                | 1SVR740841R0200 | 0.153 (0.337)             |
| 220-240 V AC                 |                             |                                 |                | 1SVR740841R1200 | 0.153 (0.337)             |
| 24-240 V AC/DC               | without                     | 0.3-1.5 A<br>1-5 A<br>3-15 A    | CM-SRS.12S     | 1SVR730840R0300 | 0.137 (0.302)             |
| 110-130 V AC                 |                             |                                 |                | 1SVR730841R0300 | 0.168 (0.370)             |
| 220-240 V AC                 |                             |                                 |                | 1SVR730841R1300 | 0.168 (0.370)             |
| 24-240 V AC/DC               | adjustable<br>0 or 0.1-30 s | 3-30 mA<br>10-100 mA<br>0.1-1 A | CM-SRS.21S     | 1SVR730840R0400 | 0.152 (0.335)             |
| 110-130 V AC                 |                             |                                 |                | 1SVR730841R0400 | 0.179 (0.395)             |
| 220-240 V AC                 |                             |                                 |                | 1SVR730841R1400 | 0.179 (0.395)             |
| 24-240 V AC/DC               |                             |                                 | CM-SRS.21P     | 1SVR740840R0400 | 0.141 (0.311)             |
| 110-130 V AC                 |                             |                                 |                | 1SVR740841R0400 | 0.168 (0.370)             |
| 220-240 V AC                 |                             |                                 |                | 1SVR740841R1400 | 0.168 (0.370)             |
| 24-240 V AC/DC               | adjustable<br>0 or 0.1-30 s | 0.3-1.5 A<br>1-5 A<br>3-15 A    | CM-SRS.22S     | 1SVR730840R0500 | 0.144 (0.399)             |
| 110-130 V AC                 |                             |                                 |                | 1SVR730841R0500 | 0.181 (0.399)             |
| 220-240 V AC                 |                             |                                 |                | 1SVR730841R1500 | 0.181 (0.399)             |
| 24-240 V AC/DC               | adjustable<br>0 or 0.1-30 s | 3-30 mA<br>10-100 mA<br>0.1-1 A | CM-SRS.M1S     | 1SVR730840R0600 | 0.153 (0.337)             |
|                              |                             |                                 | CM-SRS.M1P     | 1SVR740840R0600 | 0.142 (0.313)             |
| 24-240 V AC/DC               | adjustable<br>0 or 0.1-30 s | 0.3-1.5 A<br>1-5 A<br>3-15 A    | CM-SRS.M2S     | 1SVR730840R0700 | 0.155 (0.342)             |
| 24-240 V AC/DC               | adjustable<br>0 or 0.1-30 s | 3-30 mA<br>10-100 mA<br>0.1-1 A | CM-SFS.21S     | 1SVR730760R0400 | 0.150 (0.331)             |
|                              |                             |                                 | CM-SFS.21P     | 1SVR740760R0400 | 0.139 (0.306)             |
| 24-240 V AC/DC               | adjustable<br>0 or 0.1-30 s | 0.3-1.5 A<br>1-5 A<br>3-15 A    | CM-SFS.22S     | 1SVR730760R0500 | 0.158 (0.348)             |

## Current and voltage monitoring relays, single phase

### Ordering details, Voltage monitors



CM-ESS.MP



CM-EFS.2

#### Ordering details

| Rated control supply voltage | Tripping delay TV           | Measuring range                          | Reference code | Catalog number  | Weight (1 pce)<br>kg (lb) |
|------------------------------|-----------------------------|--|----------------|-----------------|---------------------------|
| 24-240 V AC/DC               | without                     | 3-30 V<br>6-60 V<br>30-300 V<br>60-600 V | CM-ESS.1S      | 1SVR730830R0300 | 0.135 (0.298)             |
| 110-130 V AC                 |                             |  |                | 1SVR730831R0300 | 0.164 (0.362)             |
| 220-240 V AC                 |                             |  |                | 1SVR730831R1300 | 0.164 (0.362)             |
| 24-240 V AC/DC               |                             |  | CM-ESS.1P      | 1SVR740830R0300 | 0.126 (0.278)             |
| 110-130 V AC                 |                             |  |                | 1SVR740831R0300 | 0.155 (0.342)             |
| 220-240 V AC                 |                             |  |                | 1SVR740831R1300 | 0.155 (0.342)             |
| 24-240 V AC/DC               | adjustable<br>0 or 0.1-30 s | 3-30 V<br>6-60 V<br>30-300 V<br>60-600 V | CM-ESS.2S      | 1SVR730830R0400 | 0.153 (0.337)             |
| 110-130 V AC                 |                             |  |                | 1SVR730831R0400 | 0.181 (0.399)             |
| 220-240 V AC                 |                             |  |                | 1SVR730831R1400 | 0.181 (0.399)             |
| 24-240 V AC/DC               |                             |  | CM-ESS.2P      | 1SVR740830R0400 | 0.142 (0.313)             |
| 110-130 V AC                 |                             |  |                | 1SVR740831R0400 | 0.170 (0.375)             |
| 220-240 V AC                 |                             |  |                | 1SVR740831R1400 | 0.170 (0.375)             |
| 24-240 V AC/DC               | adjustable<br>0 or 0.1-30 s | 3-30 V<br>6-60 V<br>30-300 V<br>60-600 V | CM-ESS.MS      | 1SVR730830R0500 | 0.154 (0.340)             |
|                              |                             |  | CM-ESS.MP      | 1SVR740830R0500 | 0.143 (0.320)             |
| 24-240 V AC/DC               | adjustable<br>0 or 0.1-30 s | 3-30 V<br>6-60 V<br>30-300 V<br>60-600 V | CM-EFS.2S      | 1SVR730750R0400 | 0.157 (0.346)             |
|                              |                             |  | CM-EFS.2P      | 1SVR740750R0400 | 0.146 (0.322)             |

# Current and voltage monitoring relays, single phase

## Function diagrams

Function diagrams CM-SRS.1

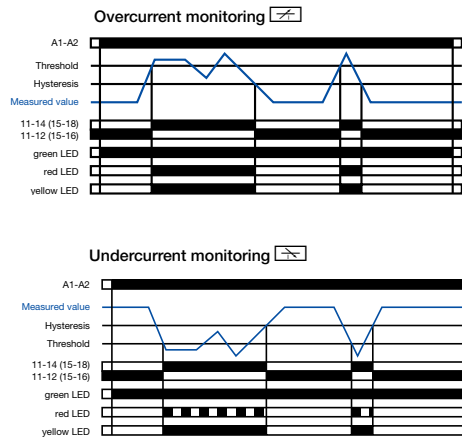

Function diagrams CM-SRS.2

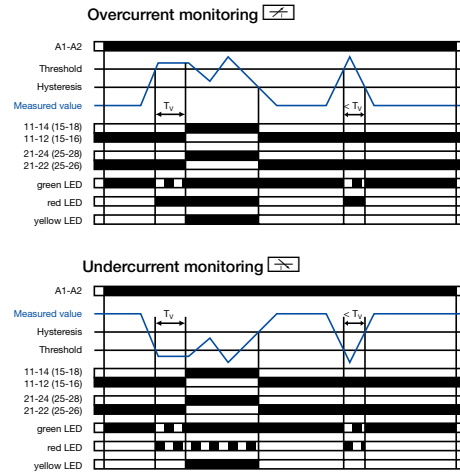

If the measured value exceeds resp. drops below the adjusted threshold value, the output relay(s) energize(s): on the CM-SRS.1 immediately, on the CM-SRS.2 after the set tripping delay  $T_v$ . If the measured value exceeds resp. drops below the threshold value plus resp. minus the adjusted hysteresis, the output relay(s) de-energize(s). The hysteresis is adjustable within a range of 3-30 % of the threshold value.

Function diagrams CM-SRS.M

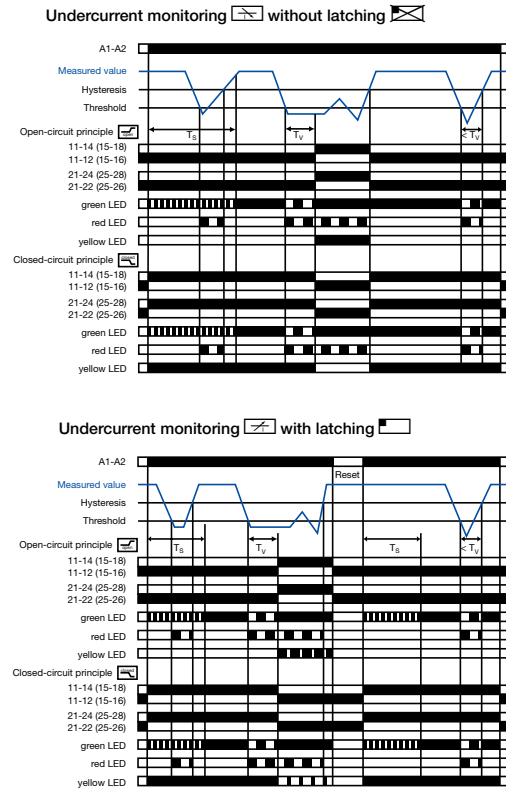
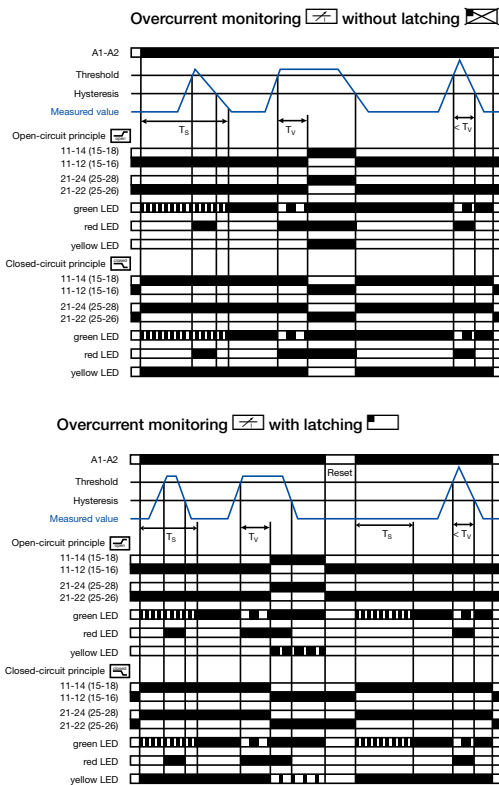

If the measured value exceeds resp. drops below the adjusted threshold value before the set start-up delay  $T_s$  is complete, the output relays do not change their actual state. If the measured value exceeds resp. drops below the adjusted threshold value when  $T_s$  is complete, the tripping delay  $T_v$  starts. If  $T_v$  is complete and the measured value is still exceeding resp. below the threshold value plus resp. minus the set hysteresis, the output relays energize  / de-energize .

If the measured value exceeds resp. drops below the threshold value minus resp. plus the set hysteresis and the latching function is not activated , the output relays de-energize  / energize . With activated latching function  the output relays remain energized  and de-energize only, when the supply voltage is interrupted / the output relays remain de-energized  and energize only, when the supply voltage is switched off and then again switched on = Reset. The hysteresis is adjustable within a range of 3-30 % of the threshold value.

# Current and voltage monitoring relays, single phase

## Function diagrams

### Function diagrams CM-SFS.2

Current window monitoring 1x2 c/o contact    
ON-delayed  without latching

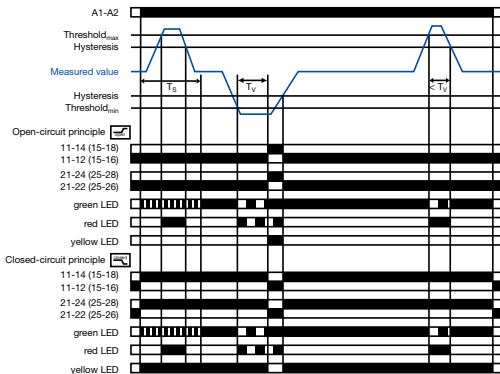

ON-delayed  current window monitoring with parallel switching c/o contacts    
If the measured value exceeds resp. drops below the adjusted threshold value before the set start-up delay  $T_s$  is complete, the output relays do not change their actual state.

If the measured value exceeds resp. drops below the adjusted threshold value when  $T_s$  is complete, the tripping delay  $T_v$  starts, when  is configured. If  $T_v$  is complete and the measured value is still exceeding resp. below the threshold value minus resp. plus the fixed hysteresis (5%), the output relays energize  / de-energize . If the measured value exceeds resp. drops below the threshold value plus resp. minus the hysteresis and the latching function is not activated  , the output relays de-energize  / energize . With activated latching function  the output relays remain energized  and de-energize only, when the supply voltage is interrupted / the output relays remain de-energized  and energize only, when the supply voltage is switched off and then again switched on = Reset.

Further function diagrams see data sheet.

Current window monitoring 1x2 c/o contact    
OFF-delayed  without latching

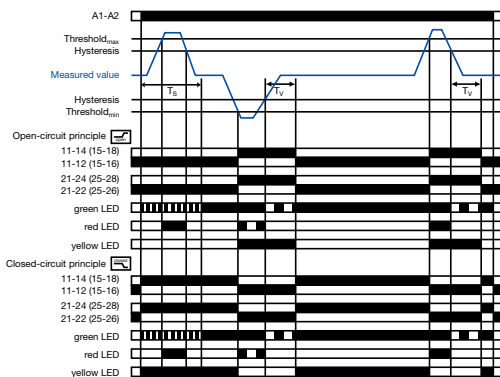

OFF-delayed  current window monitoring with parallel switching c/o contacts    
If the measured value exceeds resp. drops below the adjusted threshold value when the set start-up delay  $T_s$  is complete, the output relays energize  / de-energize  , when  is configured, and remain in this position during the set tripping delay  $T_v$ .

If the measured value exceeds resp. drops below the threshold value plus resp. minus the fixed hysteresis (5%) and the latching function is not activated  , the tripping delay  $T_v$  starts. After completion of  $T_v$  the output relays de-energize  / energize  , provided that the latching function is not activated . With activated latching function  the output relays remain energized  and de-energize only, when the supply voltage is interrupted / the output relays remain de-energized  and energize only, when the supply voltage is switched off and then again switched on = Reset.

When  is adjusted on the device, the functionality is equivalent to the one described above. There is only to consider that in this case, instead of both output relays, only one output relay each will be switched.

">" = 11<sub>15</sub>-12<sub>16</sub>/14<sub>18</sub> ; "<" = 21<sub>25</sub>-22<sub>26</sub>/24<sub>28</sub>

### Function diagrams CM-ESS.1

Overvoltage monitoring

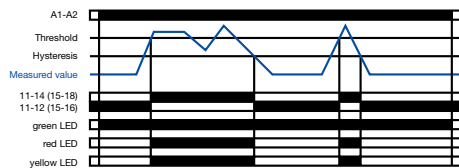

Undervoltage monitoring

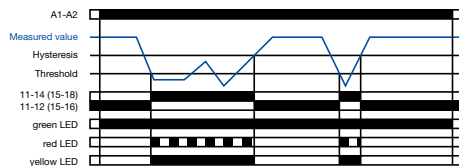

### Function diagrams CM-ESS.2

Overvoltage monitoring

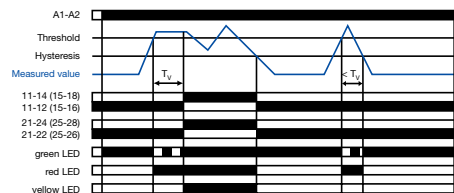

Undervoltage monitoring

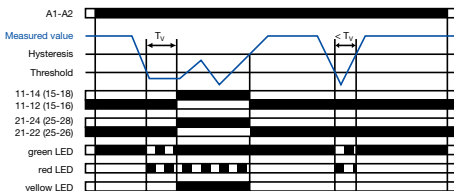

Depending on the configuration, the voltage monitoring relays **CM-ESS.1** and **CM-ESS.2** can be used for over-  or undervoltage monitoring  in single-phase AC and/or DC systems. The voltage to be monitored (measured value) is applied to terminals B-C. The devices work according to the open-circuit principle. If the measured value exceeds resp. drops below the adjusted threshold value, the output relay(s) energize(s): on the CM-ESS.1 immediately, on the CM-ESS.2 after the set tripping delay  $T_v$ . If the measured value exceeds resp. drops below the threshold value plus resp. minus the adjusted hysteresis, the output relay(s) de-energize(s). The hysteresis is adjustable within a range of 3-30 % of the threshold value.

# Current and voltage monitoring relays, single phase

## Function diagrams

Measuring & monitoring relays  
CM Range

### Function diagrams CM-ESS.M

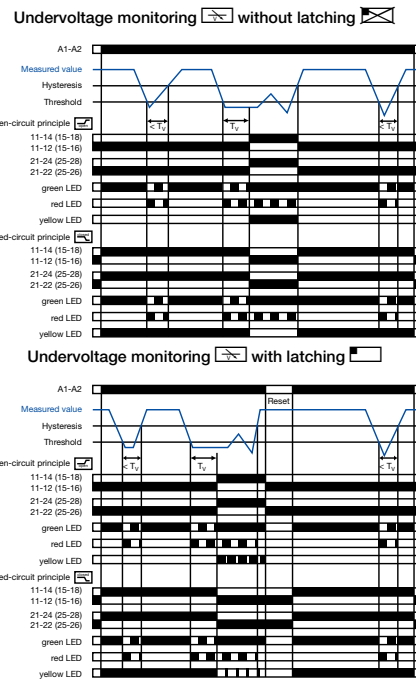
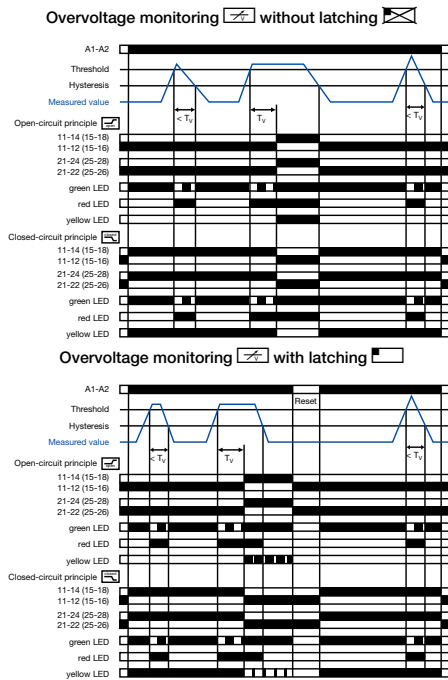

If the measured value exceeds resp. drops below the adjusted threshold value, the tripping delay  $T_v$  starts. If  $T_v$  is complete and the measured value is still exceeding resp. below the threshold value plus resp. minus the set hysteresis, the output relays energize / de-energize .

If the measured value exceeds resp. drops below the threshold value plus resp. minus the set hysteresis and the latching function is not activated , the output relays de-energize / energize . With activated latching function the output relays remain energized and de-energize only, when the supply voltage is interrupted / the output relays remain de-energized and energize only, when the supply voltage is switched off and then again switched on = Reset. The hysteresis is adjustable within a range of 3-30 % of the threshold value. Further function diagrams see data sheet.

### Voltage window monitoring 1x2 c/o contact

#### ON-delayed without latching

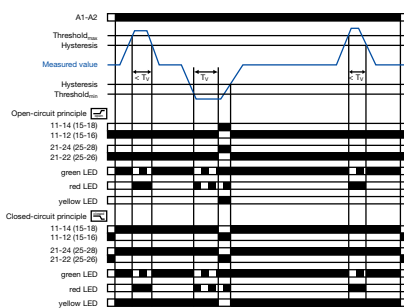

### Voltage window monitoring 1x2 c/o contact

#### OFF-delayed without latching

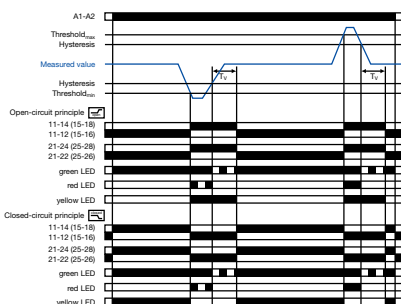

### ON-delayed voltage window monitoring with parallel switching c/o contacts

If the measured value exceeds resp. drops below the adjusted threshold value, the tripping delay  $T_v$  starts, when is configured. If  $T_v$  is complete and the measured value is still exceeding resp. below the threshold value minus resp. plus the fixed hysteresis (5%), the output relays energize / de-energize .

If the measured value exceeds resp. drops below the threshold value plus resp. minus the hysteresis and the latching function is not activated , the output relays de-energize / energize . With activated latching function the output relays remain energized and de-energize only, when the supply voltage is interrupted / the output relays remain de-energized and energize only, when the supply voltage is switched off and then again switched on = Reset.

### OFF-delayed voltage window monitoring with parallel switching c/o contacts

If the measured value exceeds resp. drops below the adjusted threshold value, the output relays energize / de-energize , when is configured, and remain in this position during the set tripping delay  $T_v$ .

If the measured value exceeds resp. drops below the threshold value plus resp. minus the fixed hysteresis (5%) and the latching function is not activated , the tripping delay  $T_v$  starts.

After completion of  $T_v$ , the output relays de-energize / energize , provided that the latching function is not activated . With activated latching function the output relays remain energized and de-energize only, when the supply voltage is interrupted / the output relays remain de-energized and energize only, when the supply voltage is switched off and then again switched on = Reset.

When is adjusted on the device, the functionality is equivalent to the one described above. There is only to consider that in this case, instead of both output relays, only one output relay each will be switched.

$$">U" = 11_{15-12_{16}}/14_{18}; "<U" = 21_{25-22_{26}}/24_{28}$$

# Current and voltage monitoring relays, single phase

## Connection diagrams

## DIP switches

### Connection diagram CM-SRS.1, CM-SRS.2

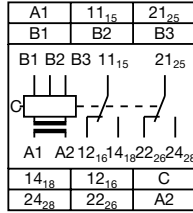
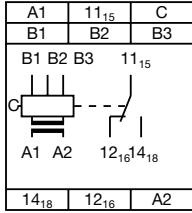

A1-A2 Control supply voltage  
B1-C Measuring range 1:  
3-30 mA or 0.3-1.5 A  
B2-C Measuring range 2:  
10-100 mA or 1-5 A  
B3-C Measuring range 3:  
0.1-1 A or 3-15 A  
11<sub>15</sub>-12<sub>16</sub>/14<sub>18</sub> Output contacts -  
open-circuit principle

A1-A2 Control supply voltage  
B1-C Measuring range 1:  
3-30 mA or 0.3-1.5 A  
B2-C Measuring range 2:  
10-100 mA or 1-5 A  
B3-C Measuring range 3:  
0.1-1 A or 3-15 A  
11<sub>15</sub>-12<sub>16</sub>/14<sub>18</sub> Output contacts -  
21<sub>25</sub>-22<sub>26</sub>/24<sub>28</sub> open-circuit principle

### DIP switch functions CM-SRS.1, CM-SRS.2

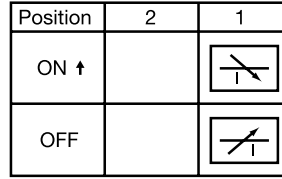

1 ON Undercurrent monitoring  
OFF Overcurrent monitoring  
OFF = Default

### Connection diagram CM-SRS.M

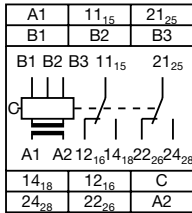

A1-A2 Control supply voltage  
B1-C Measuring range 1:  
3-30 mA bzw. 0.3-1.5 A  
B2-C Measuring range 2:  
10-100 mA bzw. 1-5 A  
B3-C Measuring range 3:  
0.1-1 A bzw. 3-15 A  
11<sub>15</sub>-12<sub>16</sub>/14<sub>18</sub> Output contacts -  
21<sub>25</sub>-22<sub>26</sub>/24<sub>28</sub> open-or  
closed circuit principle

### DIP switch functions CM-SRS.M

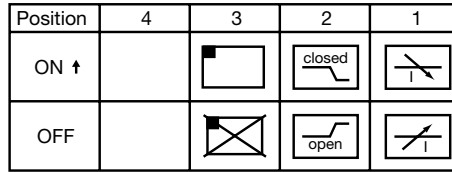

1 ON Undercurrent monitoring  
OFF Overcurrent monitoring  
3 ON Latching function activated  
OFF Latching function not activated  
2 ON Closed-circuit principle  
OFF Open-circuit principle  
OFF = Default

### Connection diagram CM-SFS.2

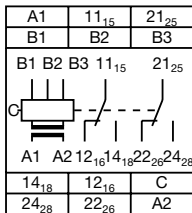

A1-A2 Control supply voltage  
B1-C Measuring range 1:  
3-30 mA or 0.3-1.5 A  
B2-C Measuring range 2:  
10-100 mA or 1-5 A  
B3-C Measuring range 3:  
0.1-1 A or 3-15 A  
11<sub>15</sub>-12<sub>16</sub>/14<sub>18</sub> Output contacts -  
21<sub>25</sub>-22<sub>26</sub>/24<sub>28</sub> open-or  
closed circuit principle

### DIP switch function CM-SFS.2

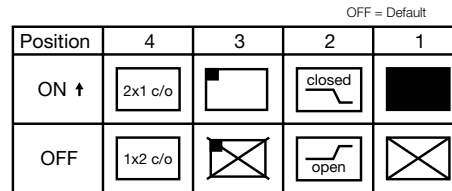

1 ON OFF-delay  
OFF ON-delay  
3 ON Latching function activated  
OFF Latching function not activated  
2 ON Closed-circuit principle  
OFF Open-circuit principle  
4 ON 2x1 c/o contact  
OFF 1x2 c/o contacts

### Connection diagram CM-ESS.M

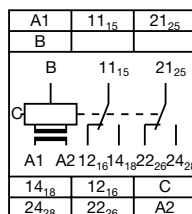

A1-A2 Control supply voltage  
B-C Measuring ranges:  
3-30 V; 6-60 V;  
30-300 V; 60-600 V  
11<sub>15</sub>-12<sub>16</sub>/14<sub>18</sub> Output contacts -  
21<sub>25</sub>-22<sub>26</sub>/24<sub>28</sub> Open- or closed circuit  
principle

### DIP switch functions CM-ESS.M

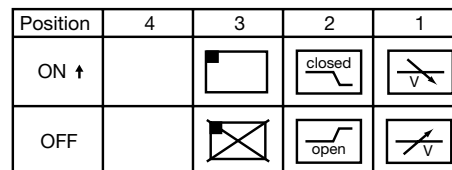

1 ON Undervoltage monitoring  
OFF Overvoltage monitoring  
3 ON Latching function activated  
OFF Latching function not activated  
2 ON Closed-circuit principle  
OFF Open-circuit principle  
OFF = Default

# Current and voltage monitoring relays, single phase

## Connection diagrams

### DIP switches

Connection diagram CM-ESS.1, CM-ESS.2

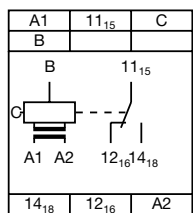

A1-A2 Control supply voltage  
B-C Measuring ranges:  
3-30 V; 6-60 V;  
30-300 V; 60-600 V  
11<sub>15</sub>-12<sub>16</sub>/14<sub>18</sub> Output contacts -  
open-circuit principle

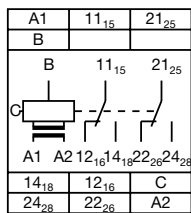

A1-A2 Control supply voltage  
B-C Measuring ranges:  
3-30 V; 6-60 V;  
30-300 V; 60-600 V  
11<sub>15</sub>-12<sub>16</sub>/14<sub>18</sub> Output contacts -  
open-circuit principle  
21<sub>25</sub>-22<sub>26</sub>/24<sub>28</sub>

DIP switch functions CM-ESS.1, CM-ESS.2

| Position | 2 | 1 |
|----------|---|---|
| ON ↑     |   |   |
| OFF      |   |   |

1 ON Undervoltage monitoring  
OFF Overvoltage monitoring  
OFF = Default

Connection diagram CM-EFS.2

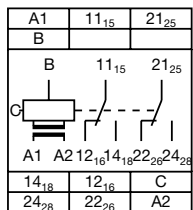

A1-A2 Control Supply voltage  
B-C Measuring ranges:  
3-30 V; 6-60 V;  
30-300 V; 60-600 V  
11<sub>15</sub>-12<sub>16</sub>/14<sub>18</sub> Output contacts -  
open- or closed circuit  
principle  
21<sub>25</sub>-22<sub>26</sub>/24<sub>28</sub>

DIP switch functions CM-EFS.2

| Position | 4 | 3 | 2 | 1 |
|----------|---|---|---|---|
| ON ↑     |   |   |   |   |
| OFF      |   |   |   |   |

OFF = Default

1 ON ON-delay  
OFF OFF-delay  
2 ON Closed-circuit principle  
OFF Open-circuit principle  
3 ON Latching function activated  
OFF Latching function not activated  
4 2 x 1 c/o contact  
1 x 2 c/o contacts

# Current and voltage monitoring relays, single phase

## Technical data

6

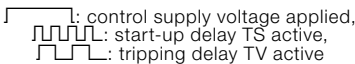
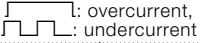
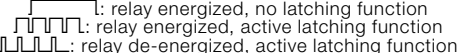
| Type  | CM-SRS.1  | CM-SRS.2         | CM-SRS.M  | CM-SFS.2                              |             |                      |
|---|---|------------------|---|---------------------------------------|-------------|----------------------|
| <b>Input circuit - Supply circuit</b>                 |   |                  |   |                                       |             |                      |
| Rated control supply voltage $U_s$                    | A1-A2<br>110-130 V AC<br>220-240 V AC<br>24-240 V AC/DC   |                  |   |                                       |             |                      |
| Rated control supply voltage $U_s$ tolerance          | -15...+10 %   |                  |   |                                       |             |                      |
| Rated frequency                                       | AC versions<br>50/60 Hz<br>AC/DC versions<br>50/60 Hz or DC   |                  |   |                                       |             |                      |
| Current / power consumption                           | see data sheets   |                  |   |                                       |             |                      |
| Power failure buffering time                          | 20 ms   |                  |   |                                       |             |                      |
| Transient overvoltage protection                      | Varistors   |                  |   |                                       |             |                      |
| <b>Input circuit - Measuring circuit</b>              |   |                  |   |                                       |             |                      |
| Monitoring function                                   | B1/B2/B3-C<br>over- or undercurrent monitoring<br>configurable  |                  |   | over- and under-current<br>monitoring |             |                      |
| Measuring method                                      | True RMS measuring principle  |                  |   |                                       |             |                      |
| Measuring inputs                                      | CM-SxS.x1   |                  | CM-SxS.x2   |                                       |             |                      |
| Terminal connection                                   | <b>B1-C</b>   | <b>B2-C</b>      | <b>B3-C</b>   | <b>B1-C</b>                           | <b>B2-C</b> | <b>B3-C</b>          |
| Measuring ranges AC/DC                                | 3-30 mA   | 10-100 mA        | 0.1-1 A   | 0.3-1.5 A                             | 1-5 A       | 3-15 A <sup>2)</sup> |
| Input resistance                                      | 3.3 q   | 1 q              | 0.1 q   | 0.05 q                                | 0.01 q      | 0.0025 q             |
| Pulse overload capacity $t < 1$ s                     | 500 mA  | 1 A              | 10 A  | 15 A                                  | 50 A        | 100 A                |
| Continuous capacity                                   | 50 mA   | 150 mA           | 1.5 A   | 2 A                                   | 7 A         | 17 A                 |
| Threshold value(s)                                    | adjustable within the indicated measuring range   |                  |   |                                       |             |                      |
| Setting accuracy of threshold value                   | 10 %  |                  |   |                                       |             |                      |
| Repeat accuracy (constant parameters)                 | 0.07 % of full scale  |                  |   |                                       |             |                      |
| Hysteresis related to the threshold value             | 3-30 % adjustable   |                  |   | 5 % fixed                             |             |                      |
| Measuring signal frequency range                      | DC / 15 Hz - 2 kHz  |                  |   |                                       |             |                      |
| Rated measuring signal frequency range                | DC / 50-60 Hz   |                  |   |                                       |             |                      |
| Maximum response time                                 | AC: 80 ms / DC: 120 ms  |                  |   |                                       |             |                      |
| Accuracy within the control supply voltage tolerance  | $\Delta U \leq 0.5 \%$  |                  |   |                                       |             |                      |
| Accuracy within the temperature range                 | $\Delta U \leq 0.06 \% / ^\circ\text{C}$  |                  |   |                                       |             |                      |
| <b>Timing circuit</b>                                 |   |                  |   |                                       |             |                      |
| Start-up delay $T_s$                                  | none  |                  | 0 or 0.1-30 s adjustable  |                                       |             |                      |
| Tripping delay $T_V$                                  | none  |                  | 0 or 0.1-30 s adjustable  |                                       |             |                      |
| Repeat accuracy (constant parameters)                 | $\pm 0.07 \%$ of full scale   |                  |   |                                       |             |                      |
| Accuracy within the control supply voltage tolerance  | $\Delta t \leq 0.5 \%$  |                  |   |                                       |             |                      |
| Accuracy within the temperature range                 | $\Delta t \leq 0.06 \% / ^\circ\text{C}$  |                  |   |                                       |             |                      |
| <b>Indication of operational states</b>               |   |                  |   |                                       |             |                      |
| Control supply voltage                                | U/T: green LED  |                  | <br>U/T: control supply voltage applied,<br>TS: start-up delay TS active,<br>TV: tripping delay TV active                                       |                                       |             |                      |
| Measured value  | I: red LED  |                  | <br>I: overcurrent,<br>I: undercurrent  |                                       |             |                      |
| Relay status  | R: yellow LED   |                  | <br>R: relay energized, no latching function<br>R: relay energized, active latching function<br>R: relay de-energized, active latching function |                                       |             |                      |
| <b>Output circuits</b>                                |   |                  |   |                                       |             |                      |
| Kind of output  | 11(15)-12(16)/14(18), 21(25)-22(26)/24(28) - Relays   |                  | 1x2 c/o contacts or 2x1 c/o contact configurable  |                                       |             |                      |
| Operating principle <sup>1)</sup>                     | open-circuit principle  |                  | open- or closed-circuit principle configurable  |                                       |             |                      |
| Contact material                                      | AgNi  |                  |   |                                       |             |                      |
| Rated operational voltage $U_o$                       | IEC/EN 60947-1<br>250 V   |                  |   |                                       |             |                      |
| Minimum switching voltage / minimum switching current | 24 V / 10 mA  |                  |   |                                       |             |                      |
| Maximum switching voltage / maximum switching current | 250 V AC / 4 A AC   |                  |   |                                       |             |                      |
| Rated operational current $I_o$ (IEC/EN 60947-5-1)    | AC12 (resistive) at 230 V<br>AC15 (inductive) at 230 V<br>DC12 (resistive) at 24 V<br>DC13 (inductive) at 24 V  |                  |   |                                       |             |                      |
| AC rating (UL 508)                                    | Utilization category (Control Circuit Rating Code)<br>max. rated operational voltage<br>max. continuous thermal current at B 300<br>max. making/breaking apparent power (Make/Break) at B 300 |                  |   |                                       |             |                      |
| Mechanical lifetime                                   | 30x10 <sup>6</sup> switching cycles   |                  |   |                                       |             |                      |
| Electrical lifetime (AC12, 230 V, 4 A)                | 0.1x10 <sup>6</sup> switching cycles  |                  |   |                                       |             |                      |
| Max. fuse rating to achieve short-circuit protection  | n/c contact   | 6 A fast-acting  | 10 A fast-acting  | 6 A fast-acting                       |             |                      |
|   | n/o contact   | 10 A fast-acting |   |                                       |             |                      |

<sup>1)</sup> Open-circuit principle: output relay energizes if the measured value exceeds  $\square$  / falls below  $\square$  the adjusted threshold value  
Closed-circuit principle: output relay de-energizes if measured value exceeds  $\square$  / falls below  $\square$  the adjusted threshold value



# Current monitoring relays, single phase

## Technical data

Measuring &  
monitoring relays  
CM Range

| Type  |  | CM-SRS.1   | CM-SRS.2 | CM-SRS.M                                    | CM-SFS.2 |
|---|--|--|----------|---|----------|
| <b>General data</b>   |  |  |          |   |          |
| MTBF  |  |  |          | on request                                  |          |
| Duty time   |  |  |          | 100%  |          |
| Dimensions  | product dimensions                     | 22.5 x 85.6 x 103.7 mm (0.89 x 3.37 x 4.08 in)   |          |   |          |
|   | packaging dimensions                   | 97 x 109 x 30 mm (3.82 x 4.29 x 1.18 in)   |          |   |          |
| (W x H x D)   |  |  |          |   |          |
| Weight  | net weight                             | depending on device, see ordering details  |          |   |          |
|   | gross weight                           | depending on device, see ordering details  |          |   |          |
| Mounting  |  | DIN rail (IEC/EN 60715),<br>snap-on mounting without any tool                              |          |   |          |
| Mounting position   |  | any  |          |   |          |
| Minimum distance to other units   |  | 10mm (0.39in) at measured current > 10 A   |          |   |          |
| Material of housing   |  | UL 94 V-0  |          |   |          |
| Degree of protection  | housing / terminals                    | IP50 / IP20  |          |   |          |
| <b>Electrical connection</b>  |  |  |          |   |          |
| Wire size   |  | Screw connection technology  |          | Easy Connect Technology (Push-in)           |          |
|   | fine-strand with(out) wire end ferrule | 1 x 0.5-2.5 mm <sup>2</sup> (1 x 20-14 AWG)<br>2 x 0.5-1.5 mm <sup>2</sup> (2 x 20-16 AWG) |          | 2 x 0.5-1.5 mm <sup>2</sup> (2 x 20-16 AWG) |          |
|   | rigid                                  | 1 x 0.5-4 mm <sup>2</sup> (1 x 20-12 AWG)<br>2 x 0.5-2.5 mm <sup>2</sup> (2 x 20-14 AWG)   |          | 2 x 0.5-1.5 mm <sup>2</sup> (2 x 20-16 AWG) |          |
| Stripping length  |  | 8 mm (0.32 in)   |          |   |          |
| Tightening torque   |  | 0.6-0.8 Nm (5.31-7.08 lb.in)   |          | -   |          |
| <b>Environmental data</b>   |  |  |          |   |          |
| Ambient temperature range   | operation / storage                    | -20...+60 °C / -40...+85 °C  |          |   |          |
| Damp heat (IEC 60068-2-30)  |  | 55 °C, 6 cycles  |          |   |          |
| Vibration (sinusoidal) (IEC/EN 60255-21-1)  |  | Class 2  |          |   |          |
| Shock (IEC/EN 60255-21-2)   |  | Class 2  |          |   |          |
| <b>Isolation data</b>   |  |  |          |   |          |
| Rated insulation voltage (VDE 0110, IEC 60947-1, IEC/EN 60255-5)                                | supply / measuring circuit / output    | 600 V  |          |   |          |
|   | supply / output 1/2                    | 250 V  |          |   |          |
| Rated impulse withstand voltage U <sub>imp</sub> (IEC/EN 60947-1, IEC/EN 60255-5) <sup>2)</sup> | supply / measuring circuit / output    | 6 kV 1.2/50 µs   |          |   |          |
|   | supply / output 1/2                    | 4 kV 1.2/50 µs   |          |   |          |
| Pollution degree (VDE 0110, IEC 664, IEC/EN 60255-5)  |  | 3  |          |   |          |
| Overvoltage category (VDE 0110, IEC 664, IEC/EN 60255-5)  |  | III  |          |   |          |
| <b>Standards</b>  |  |  |          |   |          |
| Product standard  |  | IEC/EN 60255-6   |          |   |          |
| Low Voltage Directive   |  | 2006/95/EC   |          |   |          |
| EMC Directive   |  | 2004/108/EC  |          |   |          |
| <b>Electromagnetic compatibility</b>  |  |  |          |   |          |
| Interference immunity to  |  | IEC/EN 61000-6-2   |          |   |          |
| electrostatic discharge   | IEC/EN 61000-4-2                       | Level 3  |          |   |          |
| radiated, radio-frequency, electromagnetic field  | IEC/EN 61000-4-3                       | Level 3  |          |   |          |
| electrical fast transient / burst   | IEC/EN 61000-4-4                       | Level 3  |          |   |          |
| surge   | IEC/EN 61000-4-5                       | Level 3  |          |   |          |
| conducted disturbances, induced by radio-frequency fields                                       | IEC/EN 61000-4-6                       | Level 3  |          |   |          |
| Interference emission   |  | IEC/EN 61000-6-3   |          |   |          |
| high-frequency radiated   | IEC/CISPR 22; EN 55022                 | Class B  |          |   |          |
| high-frequency conducted  | IEC/CISPR 22; EN 55022                 | Class B  |          |   |          |

<sup>2)</sup> In case of measured currents > 10 A, lateral spacing has to be min. 10 mm

# Voltage monitoring relays, single phase

## Technical data

| Type  | CM-ESS.1  | CM-ESS.2   | CM-ESS.M   | CM-EFS.2       |
|---|---|--|--|----------------|
| <b>Input circuit - Supply circuit</b>                 | A1-A2   |  |  |                |
| Rated control supply voltage $U_s$                    | A1-A2   | 110-130 V AC   |  | 220-240 V AC   |
|   | A1-A2   | 220-240 V AC   |  |                |
|   | A1-A2   | 24-240 V AC/DC   |  |                |
| Rated control supply voltage $U_s$ tolerance          |   | -15...+10 %  |  |                |
| Rated frequency                                       | AC versions                                     | 50/60 Hz   |  | 50/60 Hz or DC |
|   | AC/DC versions                                  | 50/60 Hz   |  |                |
| Current / power consumption                           |   | see data sheet   |  |                |
| Power failure buffering time                          |   | 20 ms  |  |                |
| Transient overvoltage protection                      |   | Varistors  |  |                |
| <b>6 Input circuit - Measuring circuit</b>            | B-C   |  |  |                |
| Monitoring function                                   | Over or undervoltage monitoring configurable    |  | Over and undervoltage monitoring configurable    |                |
| Measuring method                                      | True RMS measuring principle                    |  |  |                |
| Measuring inputs                                      | CM-ExS  |  |  |                |
|   | B-C   | B-C  | B-C  | B-C            |
| Terminal connection                                   | 3-30 V  | 6-60 V   | 30-300 V   | 60-600 V       |
| Measuring range AC/DC                                 | 600 k $\Omega$                                  | 600 k $\Omega$   | 600 k $\Omega$                                   | 600 k $\Omega$ |
| Input resistance                                      | 800 V   | 800 V  | 800 V  | 800 V          |
| Pulse overload capacity $t < 1$ s                     | 660 V   | 660 V  | 660 V  | 660 V          |
| Continuous capacity                                   | adjustable within the indicated measuring range |  |  |                |
| Threshold value(s)                                    | 10 %  |  |  |                |
| Setting accuracy of threshold value                   | $\pm 0.07$ % of full scale                      |  |  |                |
| Repeat accuracy (constant parameters)                 | 3-30 % adjustable                               |  | 5 % fixed  |                |
| Hysteresis related to the threshold value             | DC / 15 Hz - 2 kHz                              |  |  |                |
| Measuring signal frequency range                      | DC / 50-60 Hz                                   |  |  |                |
| Rated measuring signal frequency range                | AC: 80 ms / DC: 120 ms                          |  |  |                |
| Maximum response time                                 | $\Delta U \leq 0.5$ %                           |  |  |                |
| Accuracy within the control supply voltage tolerance  | $\Delta U \leq 0.06$ % / $^{\circ}\text{C}$     |  |  |                |
| Accuracy within the temperature range                 | Varistors                                       |  |  |                |
| Transient overvoltage protection                      |   |  |  |                |
| <b>Timing circuit</b>                                 |   |  |  |                |
| Delay time $T_v$                                      | none  | 0 or 0.1-30 s adjustable   |  |                |
| Repeat accuracy (constant parameters)                 | $\pm 0.07$ % of full scale                      |  |  |                |
| Accuracy within the control supply voltage tolerance  | -   | $\Delta t \leq 0.5$ %  |  |                |
| Accuracy within the temperature range                 | -   | $\Delta t \leq 0.06$ % / $^{\circ}\text{C}$  |  |                |
| <b>Indication of operational states</b>               |   |  |  |                |
| Control supply voltage                                | U/T: green LED                                  | : control supply voltage applied<br>: tripping delay $T_v$ active  |  |                |
| Measured value  | U: red LED                                      | : overvoltage,<br>: undervoltage   |  |                |
| Relay status  | R: yellow LED                                   | : relay energized, no latching function<br>: relay energized, active latching function<br>: relay de-energized, active latching function |  |                |
| <b>Output circuits</b>                                |   |  |  |                |
| Kind of output  | 1 c/o contact                                   | 2 c/o contacts   | 1x2 c/o contacts or 2x1 c/o contact configurable |                |
| Operating principle <sup>1)</sup>                     | open-circuit principle                          |  | open- or closed-circuit principle configurable   |                |
| Contact material                                      | AgNi  |  |  |                |
| Rated operational voltage $U_s$                       | IEC/EN 60947-1                                  |  |  |                |
| Rated operational voltage $U_s$                       | 250 V   |  |  |                |
| Minimum switching voltage / minimum switching current | 24 V / 10 mA                                    |  |  |                |
| Maximum switching voltage / maximum switching current | 250 V AC / 4 A AC                               |  |  |                |
| Rated operational current $I$                         | AC12 (resistive) at 230 V                       |  | 4 A  |                |
|   | AC15 (inductive) at 230 V                       |  | 3 A  |                |
| (IEC/EN 60947-5-1)                                    | DC12 (resistive) at 24 V                        |  | 4 A  |                |
|   | DC13 (inductive) at 24 V                        |  | 2 A  |                |

<sup>1)</sup> Open-circuit principle: output relay energizes if the measured value exceeds / falls below the adjusted threshold value  
 Closed-circuit principle: output relay de-energizes if measured value exceeds / falls below the adjusted threshold value<sup>2)</sup>

# Voltage monitoring relays, single phase

## Technical data

Measuring &  
monitoring relays  
CM Range

| Type  |  | CM-ESS.1                                    | CM-ESS.2                                    | CM-ESS.M  | CM-EFS.2        |
|---|--|---|---|---|-----------------|
| AC rating<br>(UL 508)   | Utilization category (Control Circuit Rating Code)           |   |   | B 300   |                 |
|   | max. rated operational voltage                               |   |   | 300 V AC  |                 |
|   | max. continuous thermal current at B 300                     |   |   | 5 A   |                 |
|   | max. making/breaking apparent power<br>(Make/Break) at B 300 |   |   | 3600/360 VA   |                 |
|   | Mechanical lifetime  |   |   | 30x10 <sup>6</sup> switching cycles                           |                 |
| Electrical lifetime (AC12, 230 V, 4 A)  |  |   | 0.1x10 <sup>6</sup> switching cycles        |   |                 |
| Max. fuse rating to achieve<br>short-circuit protection   | n/c contact  | 6 A fast-acting                             |   | 10 A fast-acting  | 6 A fast-acting |
|   | n/o contact  |   |   | 10 A fast-acting  |                 |
| <b>General data</b>   |  |   |   |   |                 |
| MTBF  |  |   |   | on request  |                 |
| Duty time   |  |   |   | 100%  |                 |
| Dimensions (W x H x D)  | product dimensions   |   |   | 22.5 x 85.6 x 103.7 mm (0.89 x 3.37 x 4.08 in)                |                 |
|   | packaging dimensions   |   |   | 97 x 109 x 30 mm (3.82 x 4.29 x 1.18 in)                      |                 |
| Weight  | net weight   |   |   | depending on device, see ordering details                     |                 |
|   | gross weight   |   |   | depending on device, see ordering details                     |                 |
| Mounting  |  |   |   | DIN rail (IEC/EN 60715),<br>snap-on mounting without any tool |                 |
| Mounting position   |  |   |   | any   |                 |
| Minimum distance to other units   | vertical / horizontal  |   |   | not necessary / not necessary                                 |                 |
| Material of housing   |  |   |   | UL 94 V-0   |                 |
| Degree of protection  | housing / terminals  |   |   | IP50 / IP20   |                 |
| <b>Electrical connection</b>  |  |   |   |   |                 |
| Wire size   |  | Screw connection technology                 |   | Easy Connect Technology (Push-in)                             |                 |
|   | fine-strand with(out) wire end ferrule                       | 1 x 0.5-2.5 mm <sup>2</sup> (1 x 20-14 AWG) |   | 2 x 0.5-1.5 mm <sup>2</sup> (2 x 20-16 AWG)                   |                 |
|   |  | 2 x 0.5-1.5 mm <sup>2</sup> (2 x 20-16 AWG) |   |   |                 |
| rigid   | 1 x 0.5-4 mm <sup>2</sup> (1 x 20-12 AWG)                    |   | 2 x 0.5-1.5 mm <sup>2</sup> (2 x 20-16 AWG) |   |                 |
| Stripping length  |  |   |   | 8 mm (0.32 in)  |                 |
| Tightening torque   |  | 0.6-0.8 Nm (5.31-7.08 lb.in)                |   | -   |                 |
| <b>Isolation data</b>   |  |   |   |   |                 |
| Rated insulation voltage (VDE 0110,<br>IEC 60947-1, IEC/EN 60255-5)                               | supply / measuring<br>circuit / output                       |   |   | 600 V   |                 |
|   | supply / output 1/2  |   |   | 250 V   |                 |
|   | supply / output 1/2  |   |   |   |                 |
| Rated impulse withstand voltage U <sub>i</sub><br>(IEC/EN 60947-1, IEC/EN 60255-5) <sup>imp</sup> | supply / measuring<br>circuit / output                       |   |   | 6 kV 1.2/50 μs  |                 |
|   | supply / output 1/2  |   |   | 4 kV 1.2/50 μs  |                 |
|   | supply / output 1/2  |   |   |   |                 |
| Pollution degree (VDE 0110, IEC 664, IEC/EN 60255-5)  |  |   |   | 3   |                 |
| Overvoltage category (VDE 0110, IEC 664, IEC/EN 60255-5)  |  |   |   | III   |                 |
| <b>Standards</b>  |  |   |   |   |                 |
| Product standard  |  |   |   | IEC/EN 60255-6  |                 |
| Low Voltage Directive   |  |   |   | 2006/95/EC  |                 |
| EMC Directive   |  |   |   | 2004/108/EC   |                 |
| <b>Electromagnetic compatibility</b>  |  |   |   |   |                 |
| Interference immunity to  |  |   |   | IEC/EN 61000-6-2  |                 |
| electrostatic discharge   | IEC/EN 61000-4-2   |   |   | Level 3   |                 |
| radiated, radio-frequency,<br>electromagnetic field   | IEC/EN 61000-4-3   |   |   | Level 3   |                 |
| electrical fast transient / burst   | IEC/EN 61000-4-4   |   |   | Level 3   |                 |
| surge   | IEC/EN 61000-4-5   |   |   | Level 3   |                 |
| conducted disturbances, induced by<br>radio-frequency fields                                      | IEC/EN 61000-4-6   |   |   | Level 3   |                 |
| Interference emission   |  |   |   | IEC/EN 61000-6-3  |                 |
| high-frequency radiated   | IEC/CISPR 22; EN 55022                                       |   |   | Class B   |                 |
| high-frequency conducted  | IEC/CISPR 22; EN 55022                                       |   |   | Class B   |                 |

6



CM-E Range

# Three-phase monitoring relays





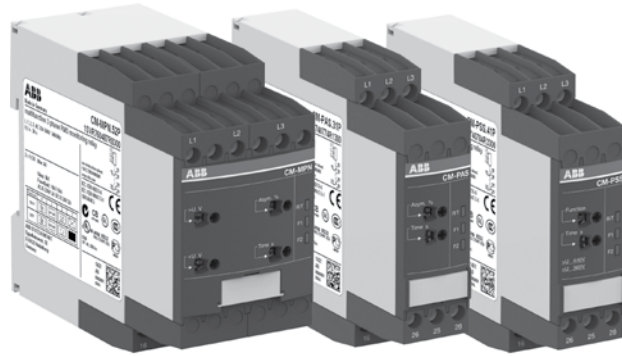



Three-phase monitoring relays  
Benefits, advantages, & applications



# Three-phase monitoring relays

## Benefits, advantages, & applications

### Characteristics of the CM range three-phase monitors

- Adjustable phase unbalance threshold value <sup>1)</sup>
- Adjustable ON-delay/OFF-delay time <sup>1)</sup>
- Dual frequency measuring 50/60 Hz
- Powered by the measuring circuit
- 1 n/o contact, 1 or 2 contacts
- LED status indication
- Approvals:     
- Marks:  
- Multifunctional and single-functional devices
- Phase loss monitoring
- Phase sequence monitoring <sup>1)</sup>
- Over- and undervoltage monitoring (fixed or adjustable)<sup>1)</sup>
- Wide-range operating voltage guarantees world-wide operation

<sup>1)</sup> depending on device type

### Phase unbalance monitoring

If the supply by the three-phase system is unbalanced due to uneven distribution of the load, the motor will convert a part of the energy into reactive power. This energy gets lost unexploited; also the motor is exposed to higher thermal strain. Other thermal protection devices fail to detect continuing unbalances which can lead to damage or destruction of the motor. The CM range three-phase monitors with phase unbalance monitoring can reliably detect this critical situation.

### Phase sequence

Changing the phase sequence during operation or a wrong phase sequence prior to startup causes a change of the rotational direction of the connected device. Generators, pumps or fans rotate in the wrong direction and the installation is no longer working properly. Especially for moveable equipment, such as construction machinery, phase sequence detection prior to the startup process is highly reasonable.

### Phase loss

In case of phase loss, undefined stats of the installation are likely to occur. E.g. the startup process of motors is disturbed. All three-phase monitors of the ABB CM range detect a phase loss as soon as the voltage of one phase drops below 60% of its nominal value.

### Voltage monitoring

All electric devices can be damaged when operated continuously in a network with out-of-range voltages. For example, safe starting is not ensured in case of undervoltage. Also, the switching state of a contactor is not clearly defined when operated in a „forbidden“ voltage range. This can lead to undefined stats of the installation and cause damage or destruction of valuable parts.

### Expanded functionality

ABB's new generation of three-phase monitoring relays feature additional functions making the application field for the devices considerably larger.

### Selectable phase sequence monitoring

The phase sequence monitoring can be switched off by means of a rotary switch or a DIP switch. This enables monitoring of three-phase mains where phase sequence is not relevant for the application, for example in case of motors with forward and reverse rotation, heating applications, etc.

### Automatic phase sequence correction

The automatic phase sequence correction is activated by means of a DIP switch. With activated phase sequence correction, it is ensured that for any non-fixed or portable equipment, e.g. construction machinery, the correct phase sequence is always applied to the input terminals of the load. For details regarding the wiring, please see function description / diagrams.

### Structure of the type designation

#### CM-\_\_ x.yz

x: width of enclosure

y: Control supply voltage / measuring range

|   |  |
|---|--|
| 1 | 110, 115, 120, 127 V supply systems (phase-neutral)              |
| 2 | 220, 230, 240 V supply systems (phase-neutral)                   |
| 3 | 200, 208, 220, 230, 240, 257, 260 V supply systems (phase-phase) |
| 4 | 440, 460 V supply systems (phase-phase)                          |
| 5 | 480, 500 V supply systems (phase-phase)                          |
| 6 | 575, 600 V supply systems (phase-phase)                          |
| 7 | 660, 690 V supply systems (phase-phase)                          |
| 8 | 200, 400 V supply systems (phase-phase)                          |

z: Rated frequency / output circuit

|   |                                 |
|---|---------------------------------|
| 1 | 50/60 Hz – 1x2 c/o              |
| 2 | 50/60 Hz – 1x2 or 2x1 c/o       |
| 3 | 50/60/400 Hz – 1x2 oder 2x1 c/o |



- 1** Threshold value  $V_{min}/V_{max}$
- 2** R/T: yellow LED  
Relay status, timing
- 3** F1: red LED  
fault message
- F2: red LED failure:**  
- overvoltage: F1  
- undervoltage: F2  
- phase unbalance: F1 and F2 constant  
- phase loss: F1 on F2 flashing  
- phase sequence: F1 and F2 alternately flashing
- 4** Adjustment of the tripping delay
- 4** Time setting 0.1-10 s  
Phase sequence and phase loss are indicated without any time delay







# Three-phase monitoring relays

## Ordering details

### Description

Only reliable and continuous monitoring of a three-phase network guarantees the trouble-free and economic operation of machines and installations.



CM-PBE



CM-PSS.41P



CM-PAS.31P

### Ordering details

| Rated control supply voltage = measuring voltage | Monitoring function   | Neutral monitoring | Reference code       | Catalog number  | Weight (1 pce)<br>kg (lb) |
|--|---|--------------------|----------------------|-----------------|---------------------------|
| 3x380-440 V AC,<br>220-240 V AC                  | Phase failure detection (Single- and three-phase)                           | ■                  | CM-PBE <sup>1)</sup> | 1SVR550881R9400 | 0.08 (0.17)               |
| 3x380-440 V AC                                   |   |                    | CM-PBE               | 1SVR550882R9500 | 0.08 (0.17)               |
| 3x320-460 V AC,<br>185-265 V AC                  | Over- / under-voltage and phase failure detection (Single- and three-phase) | ■                  | CM-PVE <sup>1)</sup> | 1SVR550870R9400 | 0.08 (0.17)               |
| 3x320-460 V AC                                   |   |                    | CM-PVE               | 1SVR550871R9500 | 0.08 (0.17)               |
| 3x208-440 V AC                                   | Phase sequence monitoring and phase failure detection (Three-phase)         |                    | CM-PFE <sup>2)</sup> | 1SVR550824R9100 | 0.08 (0.17)               |
| 3x200-500 V AC                                   |   |                    | CM-PFS <sup>2)</sup> | 1SVR430824R9300 | 0.15 (0.33)               |
| 3x380 V AC                                       | Over- / undervoltage with fixed threshold values ± 10 %                     |                    | CM-PSS.31S           | 1SVR730784R2300 | 0.132 (0.291)             |
|  |   |                    | CM-PSS.31P           | 1SVR740784R2300 | 0.123 (0.271)             |
| 3x400 V AC                                       |   |                    | CM-PSS.41S           | 1SVR740784R3300 | 0.132 (0.291)             |
|  |   |                    | CM-PSS.41P           | 1SVR730784R3300 | 0.123 (0.271)             |
| 3x160-300 V AC                                   | Over- and under-voltage with adjustable threshold values (Three-phase)      |                    | CM-PVS.31S           | 1SVR730794R1300 | 0.141 (0.311)             |
|  |   |                    | CM-PVS.31P           | 1SVR740794R1300 | 0.132 (0.291)             |
| 3x300-500 V AC                                   |   |                    | CM-PVS.41S           | 1SVR730794R3300 | 0.139 (0.306)             |
|  |   |                    | CM-PVS.41P           | 1SVR740794R3300 | 0.131 (0.289)             |
| 3x200-400 V AC                                   |   |                    | CM-PVS.81S           | 1SVR730794R2300 | 0.136 (0.300)             |
|  |   |                    | CM-PVS.81P           | 1SVR740794R2300 | 0.128 (0.282)             |
| 3x160-300 V AC                                   | Phase unbalance (Three-phase)   |                    | CM-PAS.31S           | 1SVR730774R1300 | 0.133 (0.293)             |
|  |   |                    | CM-PAS.31P           | 1SVR740774R1300 | 0.124 (0.273)             |
| 3x300-500 V AC                                   |   |                    | CM-PAS.41S           | 1SVR730774R3300 | 0.132 (0.291)             |
|  |   |                    | CM-PAS.41P           | 1SVR740774R3300 | 0.123 (0.271)             |

<sup>1)</sup> The version with neutral monitoring is also suitable for monitoring single-phase mains. For this, all three external conductors (L1,L2,L3) have to be jumpered and connected as one single conductor.

<sup>2)</sup> For applications where a reverse fed voltage >60% is expected, we recommend to use our three-phase monitoring relays for unbalance CM-PAS.xx

## Three-phase monitoring relays

### Ordering details

#### Ordering details

| Rated control supply voltage = measuring voltage | Monitoring function  | Neutral monitoring   | Reference code  | Catalog number  | Weight (1 pce)<br>kg (lb) |               |
|--|--|--|-----------------|-----------------|---------------------------|---------------|
| 90-170 V AC                                      | Multifunctional (Three-phase phase failure detection, Phase sequence monitoring, overvoltage, undervoltage, Phase unbalance) | ■  | CM-MPS.11S      | 1SVR730885R1300 | 0.148 (0.326)             |               |
|  |  |  | CM-MPS.11P      | 1SVR740885R1300 | 0.137 (0.302)             |               |
| CM-MPS.21S                                       |  |  | 1SVR730885R3300 | 0.146 (0.322)   |                           |               |
| CM-MPS.21P                                       |  |  | 1SVR740885R3300 | 0.135 (0.298)   |                           |               |
| 3x300-500 V AC                                   |  |  | CM-MPS.31S      | 1SVR730884R1300 | 0.142 (0.313)             |               |
|  |  |  | CM-MPS.31P      | 1SVR740884R1300 | 0.133 (0.293)             |               |
|  |  | CM-MPS.41S   | 1SVR730884R3300 | 0.140 (0.309)   |                           |               |
|  |  | CM-MPS.41P   | 1SVR740884R3300 | 0.132 (0.291)   |                           |               |
| 180-280 V AC                                     |  | Multifunctional (Three-phase phase failure detection, Phase sequence monitoring, overvoltage, undervoltage, Phase unbalance) | ■               | CM-MPS.23S      | 1SVR730885R4300           | 0.149 (0.328) |
|  |  |  |                 | CM-MPS.23P      | 1SVR740885R4300           | 0.138 (0.304) |
| 3x300-500 V AC                                   | CM-MPS.43S   |  | 1SVR730884R4300 | 0.148 (0.327)   |                           |               |
|  | CM-MPS.43P   |  | 1SVR740884R4300 | 0.137 (0.302)   |                           |               |
| 3x350-580 V AC                                   | CM-MPN.52S   |  | 1SVR750487R8300 | 0.230 (0.507)   |                           |               |
|  | CM-MPN.52P   |  | 1SVR760487R8300 | 0.226 (0.498)   |                           |               |
| 3x450-720 V AC                                   | CM-MPN.62S   |  | 1SVR750488R8300 | 0.229 (0.505)   |                           |               |
|  | CM-MPN.62P   |  | 1SVR760488R8300 | 0.225 (0.496)   |                           |               |
| 3x530-820 V AC                                   | CM-MPN.72S   |  | 1SVR750489R8300 | 0.224 (0.494)   |                           |               |
|  | CM-MPN.72P   |  | 1SVR760489R8300 | 0.220 (0.485)   |                           |               |
| 3 x 400 V AC (L-L) / 230 V AC (L-N)              | see Three-Phase overview page  | ■  | CM-UFS.2        | 1SVR630736R1300 | 0.140 (0.309)             |               |
| 24-240 V AC/DC                                   | Grid feeding monitoring (overvoltage, undervoltage, change in grid frequency)  |  | CM-UFD.M21      | 1SVR510730R0300 | 0.225 (0.496)             |               |
| 24 V AC/DC or 230 V AC                           |  |  | CM-UFD.M32      | 1SVR510730R4400 | 0.395 (0.871)             |               |



CM-MPS.23P



CM-MPN.52P

# Three-phase monitoring relays

## Function diagrams

### Function diagrams - Three-phase monitoring CM-PBE

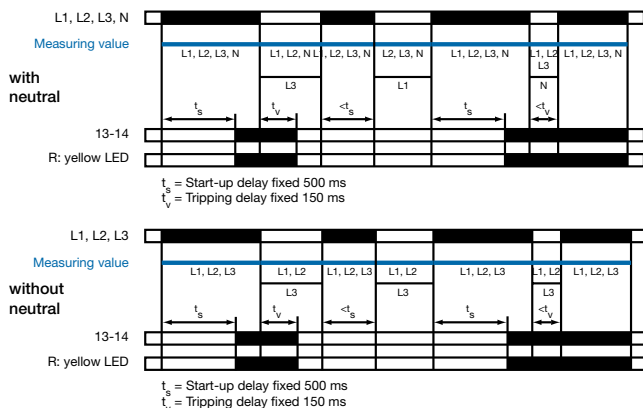

If all phases (and the neutral) are present, the output relay energizes after the start-up delay  $t_s$  is complete. If a phase failure occurs, the tripping delay  $t_v$  starts. When timing is complete, the output relay de-energizes. As soon as the voltage returns to the tolerance range, timing of  $t_s$  starts. When timing is complete, the output relay re-energizes automatically. The yellow LED glows when the output relay is energized.

### Function diagrams - Three-phase monitoring CM-PVE

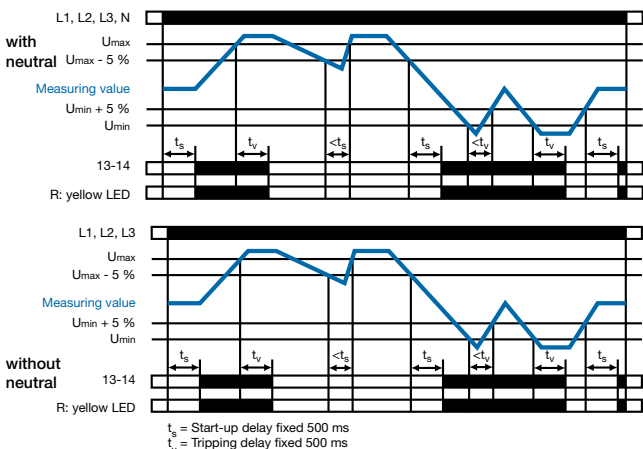

If all phases (and the neutral) are present with correct voltage, the output relay energizes after the start-up delay  $t_s$  is complete. If the voltage exceeds or falls below the fixed threshold value or if a phase failure occurs, the tripping delay  $t_v$  starts. When timing is complete, the output relay de-energizes. As soon as the voltage returns to the tolerance range, timing of  $t_s$  starts. When timing is complete, the output relay re-energizes automatically. The yellow LED glows when the output relay is energized.

### Function diagram - CM-PFE

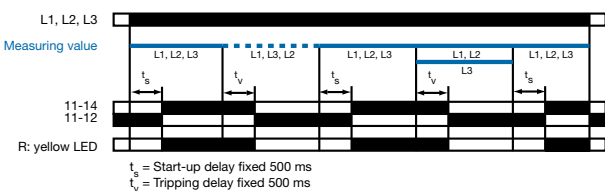

If all phases are present with the correct phase sequence, the output relay energizes after the start-up delay  $t_s$  is complete. If a phase failure or a phase sequence error occurs, the tripping delay  $t_v$  starts. When timing is complete, the output relay de-energizes. The yellow LED glows when the output relay is energized.

In case of motors which continue running with only two phases, the CM-PFE detects phase failure if the reverse fed voltage is less than 60 % of the originally applied voltage.

### Function diagram - CM-PFS

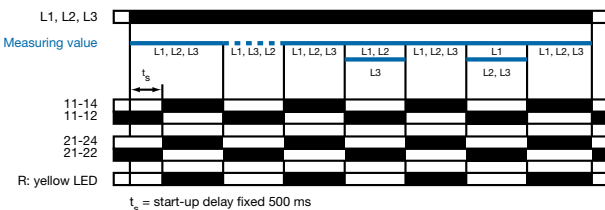

If all phases are present with the correct phase sequence, the output relay energizes after the start-up delay  $t_s$  is complete. If a phase failure or a phase sequence error occurs, the output relay de-energizes instantaneously. The yellow LED glows when the output relay is energized.

In case of motors which continue running with only two phases, the CM-PFS detects phase failure if the reverse fed voltage is less than 60 % of the originally applied voltage.

#### ATTENTION

If several CM-PFS units are placed side by side and the control supply voltage is higher than 415 V, spacing of at least 10 mm has to be kept between the individual units.

# Three-phase monitoring relays

## Function diagrams

### Phase sequence and phase failure monitoring CM-PSS.xx, CM-PVS.xx, CM.PAS.xx, CM-MPS.xx, CM-MPN.xx

Applying control supply voltage begins the fixed start-up delay  $t_s$ . When  $t_s$  is complete and all phases are present with correct voltage, the output relays energize and the yellow LED R/T glows.

#### Phase sequence monitoring

If phase sequence monitoring is activated, the output relays de-energize as soon as a phase sequence error occurs. The fault is displayed by alternated flashing of the LEDs F1 and F2. The output relays re-energize automatically as soon as the phase sequence is correct again.

#### Phase failure monitoring

The output relays de-energize instantaneous if a phase failure occurs. The fault is indicated by lightning of LED F1 and flashing of LED F2. The output relays re-energize automatically as soon as the voltage returns to the tolerance range.

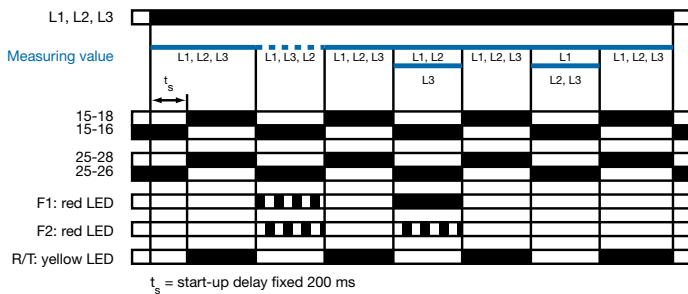

### Interrupted neutral monitoring CM-MPS.11, CM-MPS.21, CM-MPS.23

The interruption of the neutral in the main to be monitored is detected by means of phase unbalance evaluation.

Determined by the system, in case of unloaded neutral, i.e. symmetrical load between all three phases, it may happen that an interruption of the neutral will not be detected.

If the star point is displaced by asymmetrical load in the three-phase main, an interrupted neutral will be detected.

#### Displacement of the star point

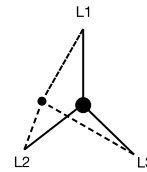

### Automatic phase sequence correction CM-MPS.x3, CM-MPN.x2

This function can be selected only if phase sequence monitoring is activated and operating mode 2x1 c/o (SPDT) contact is selected.

Applying control supply voltage begins the fixed start-up delay  $t_{s1}$ . When  $t_{s1}$  is complete and all phases are present with correct voltage, output relay R1 energizes. Output relay R2 energizes when the fixed start-up delay  $t_{s2}$  is complete and all phases are present with correct phase sequence. Output relay R2 remains de-energized if the phase sequence is incorrect.

If the voltage to be monitored exceeds or falls below the set threshold values for phase unbalance, over- or undervoltage or if a phase failure occurs, output relay R1 de-energizes and the LEDs F1 and F2 indicate the fault.

Output relay R2 is responsive only to a false phase sequence. In conjunction with a reversing contactor combination, this enables an automatic correction of the rotation direction. See circuit diagrams on the right.

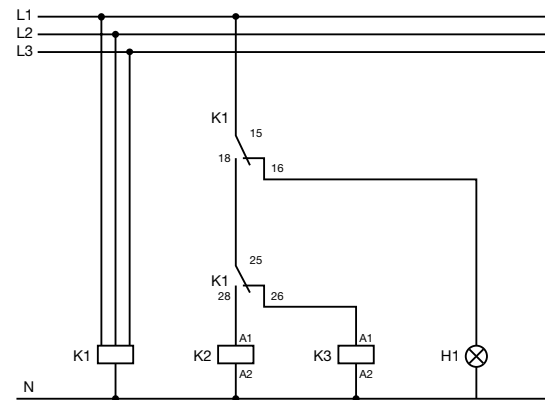
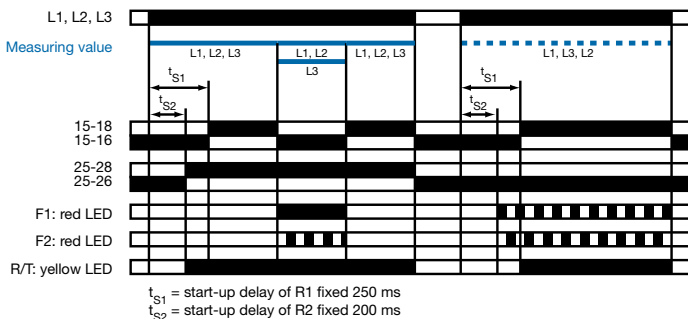

Control circuit diagram (K1 = CM-MPS.xx or CM-MPN.xx)

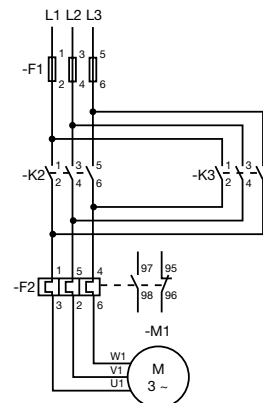

Power circuit diagram

# Three-phase monitoring relays

## Function diagrams

### Over- and undervoltage monitoring 1x2 c/o

CM-PSS.xx<sup>1</sup>, CM-PVS.xx<sup>2</sup>, CM-MPS.xx<sup>2</sup>, CM-MPN.xx<sup>2</sup>

Applying control supply voltage begins the fixed start-up delay  $t_s$ . When  $t_s$  is complete and all phases are present with correct voltage and with correct phase sequence, the output relays energize and the yellow LED R/T glows.

#### Type of tripping delay = ON-delay

If the voltage to be monitored exceeds or falls below the fixed<sup>1)</sup> or set<sup>2)</sup> threshold value, the output relays de-energize after the set tripping delay  $t_v$  is complete. The LED R/T flashes during timing and turns off as soon as the output relays de-energize.

The output relays re-energize automatically as soon as the voltage returns to the tolerance range, taking into account a fixed hysteresis of 5 % and the LED R/T glows.

#### Type of tripping delay = OFF-delay

If the voltage to be monitored exceeds or falls below the fixed<sup>1)</sup> or set<sup>2)</sup> threshold value, the output relays de-energize instantaneously and the LED R/T turns off.

As soon as the voltage returns to the tolerance range, taking into account a fixed hysteresis of 5 %, the output relays re-energize automatically after the set tripping delay  $t_v$  is complete. The LED R/T flashes during timing and turns steady when timing is complete.

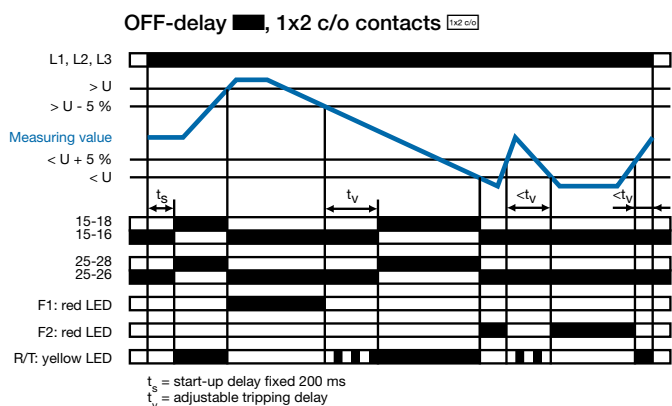
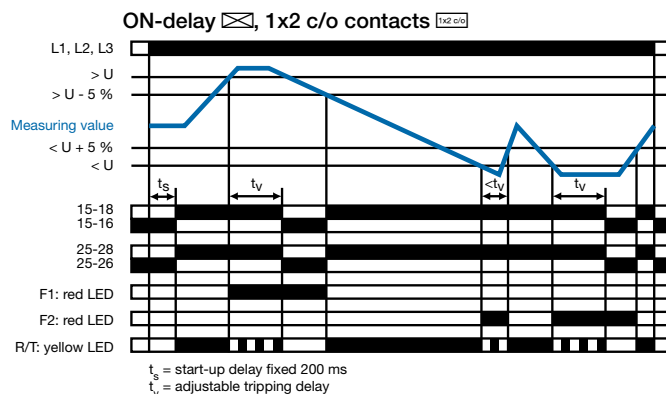

### Over- and undervoltage monitoring 2x1 c/o

CM-MPS.x3, CM-MPN.x2

Applying control supply voltage begins the fixed start-up delay  $t_s$ . When  $t_s$  is complete and all phases are present with correct voltage and with correct phase sequence, the output relays energize. The yellow LED R/T glows as long as at least one output relay is energized.

#### Type of tripping delay = ON-delay

If the voltage to be monitored exceeds or falls below the set threshold value, output relay R1 (overvoltage) or output relay R2 (undervoltage) de-energizes after the set tripping delay  $t_v$  is complete. The LED R/T flashes during timing.

The corresponding output relay re-energizes automatically as soon as the voltage returns to the tolerance range, taking into account a fixed hysteresis of 5 %.

#### Type of tripping delay = OFF-delay

If the voltage to be monitored exceeds or falls below the set threshold value, output relay R1 (overvoltage) or output relay R2 (undervoltage) de-energizes instantaneously.

As soon as the voltage returns to the tolerance range, taking into account a fixed hysteresis of 5 %, the corresponding output relay re-energizes automatically after the set tripping delay  $t_v$  is complete. The LED R/T flashes during timing.

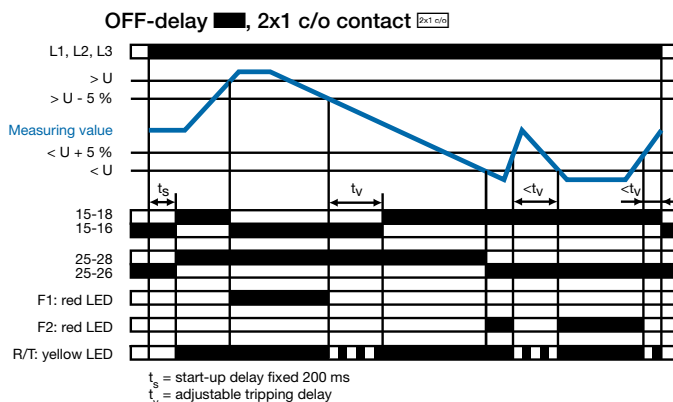
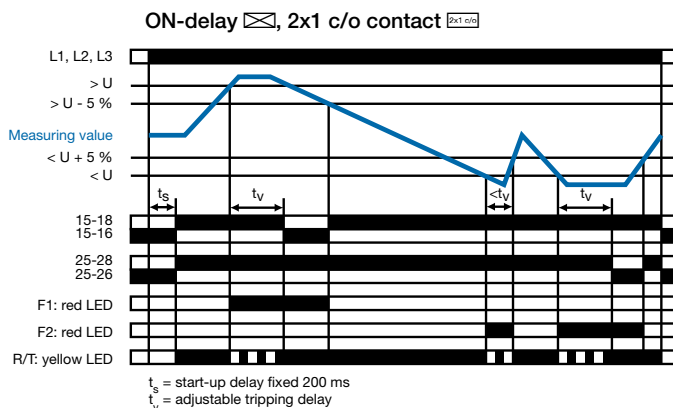

# Three-phase monitoring relays

## Function diagrams

### Phase unbalance monitoring CM-PAS.xx, CM-MPS.xx, CM-MPN.xx

Applying control supply voltage begins the fixed start-up delay  $t_s$ . When  $t_s$  is complete and all phases are present with correct voltage and with correct phase sequence, the output relays energize and the yellow LED R/T glows.

#### Type of tripping delay = ON-delay

If the voltage to be monitored exceeds or falls below the set phase unbalance threshold value, the output relays de-energize after the set tripping delay  $t_v$  is complete. The LED R/T flashes during timing and turns off as soon as the output relays de-energize.

6 The output relays re-energize automatically as soon as the voltage returns to the tolerance range, taking into account a fixed hysteresis of 20 % and the LED R/T glows.

#### Type of tripping delay = OFF-delay

If the voltage to be monitored exceeds or falls below the set phase unbalance threshold value, the output relays de-energize instantaneously and the LED R/T turns off.

As soon as the voltage returns to the tolerance range, taking into account a fixed hysteresis of 20 %, the output relays re-energize automatically after the set tripping delay  $t_v$  is complete. The LED R/T flashes during timing and turns steady when timing is complete.

### ON-delay ☒

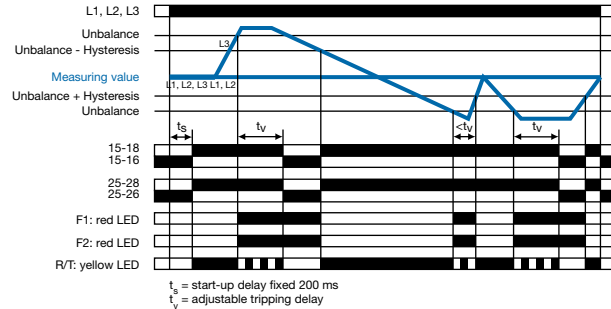

### OFF-delay ■

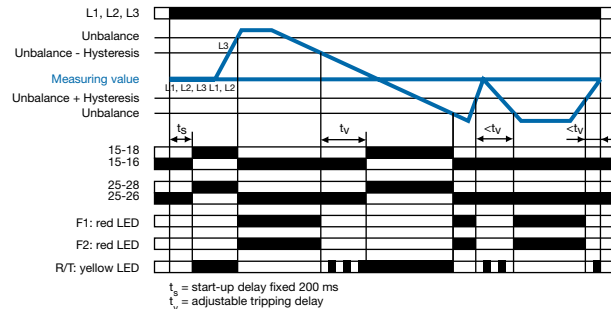

### LED functions CM-PSS.xx, CM-PSV.xx, CM-PAS.xx, CM-MPS.xx, CM-MPN.xx

| Function   | R/T:<br>yellow LED | F1:<br>red LED | F2:<br>red LED |
|--|--------------------|----------------|----------------|
| Control supply voltage applied, output relay energized |                    | -              | -              |
| Tripping delay $t_v$ active                            |                    | -              | -              |
| Phase failure  | -                  |                |                |
| Phase sequence   | -                  |                |                |
| Overvoltage  | -                  |                | -              |
| Undervoltage   | -                  | -              |                |
| Phase unbalance  | -                  |                |                |
| Interruption of the neutral                            | -                  |                |                |
| Adjustment error <sup>1)</sup>                         |                    |                |                |

<sup>1)</sup> Possible misadjustments of the front-face operating controls:

Overlapping of the threshold values: An overlapping of the threshold values is given, if the threshold value for overvoltage is set to a smaller value than the threshold value for undervoltage.

DIP switch 3 = OFF and DIP switch 4 = ON: Automatic phase sequence correction is activated and selected operating mode is 1x2 c/o contacts

DIP switch 2 and 4 = ON: Phase sequence detection is deactivated and the automatic phase sequence correction is activated

### Type of tripping delay CM-PSS.xx, CM-PSV.xx, CM-PAS.xx, CM-MPS.xx, CM-MPN.xx

The type of tripping delay ☒ / ■ can be adjusted via a rotary (CM-PxS.xx) or a DIP switch (CM-MPx.xx).

#### Switch position ON-delay ☒:

In case of a fault, the de-energizing of the output relays and the respective fault message are suppressed for the adjusted tripping delay  $t_v$ .

#### Switch position OFF-delay ■:

In case of a fault, the output relays de-energize instantaneously and a fault message is displayed and stored for the length of the adjusted tripping delay  $t_v$ . Thereby, also momentary undervoltage conditions are recognized.

# Three-phase monitoring relays Function diagrams

## Grid feeding monitoring CM-UFS.2

### Function of the yellow LED

The yellow LED is flashing during timing and turns steady as soon as the output relays are energized.

### Phase failure monitoring

Applying control supply voltage begins the fixed start-up delay  $t_{S1}$ . When  $t_{S1}$  is complete and all phases are present with correct voltage and frequency, the output relays energize. They de-energize instantaneously if a phase failure occurs. The fault is indicated by LEDs.

As soon as all 3 phases are present again, the output relays re-energize automatically after the set restart delay  $t_{S2}$  is complete.

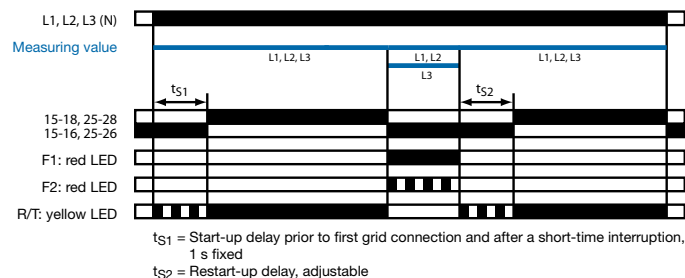

## Over- and underfrequency monitoring

Applying control supply voltage begins the fixed start-up delay  $t_{S1}$ . When  $t_{S1}$  is complete and all phases are present with correct voltage and frequency, the output relays energize.

If the frequency to be monitored exceeds or falls below the fixed threshold value, the output relays deenergize instantaneously. The fault type is indicated by LEDs. As soon as the frequency returns to the tolerance range, taking into account a fixed hysteresis, the output relays re-energize after the set restart delay  $t_{S2}$  is complete.

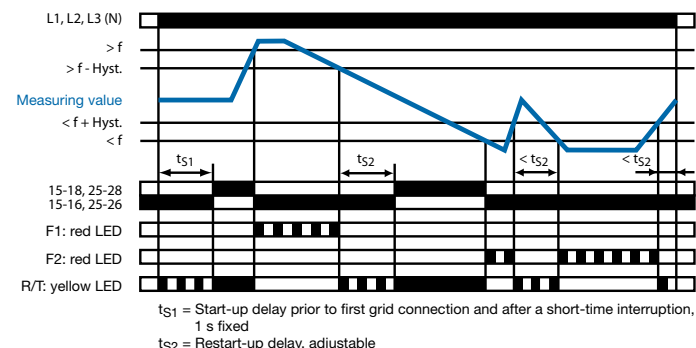

## Over- and undervoltage monitoring

Applying control supply voltage begins the fixed start-up delay  $t_{S1}$ . When  $t_{S1}$  is complete and all phases are present with correct voltage and frequency, the output relays energize.

If the voltage to be monitored exceeds or falls below the fixed threshold value, the output relays de-energize instantaneously. The fault type is indicated by LEDs. As soon as the voltage returns to the tolerance range, taking into account a fixed hysteresis of 5 %, the output relays re-energize after the set restart delay  $t_{S2}$  is complete.

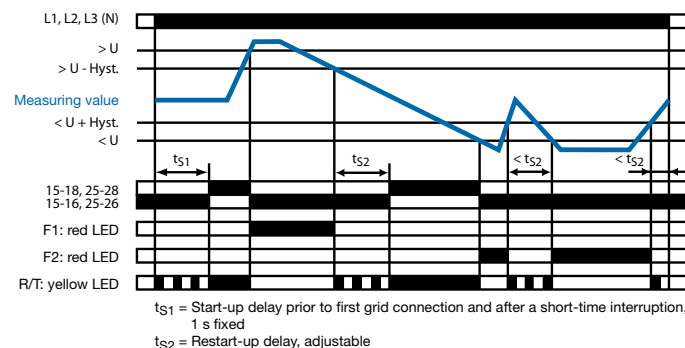

## Function diagram legend

- Control supply voltage not applied / Output contact open / LED off
- Control supply voltage applied / Output contact closed / LED glowing

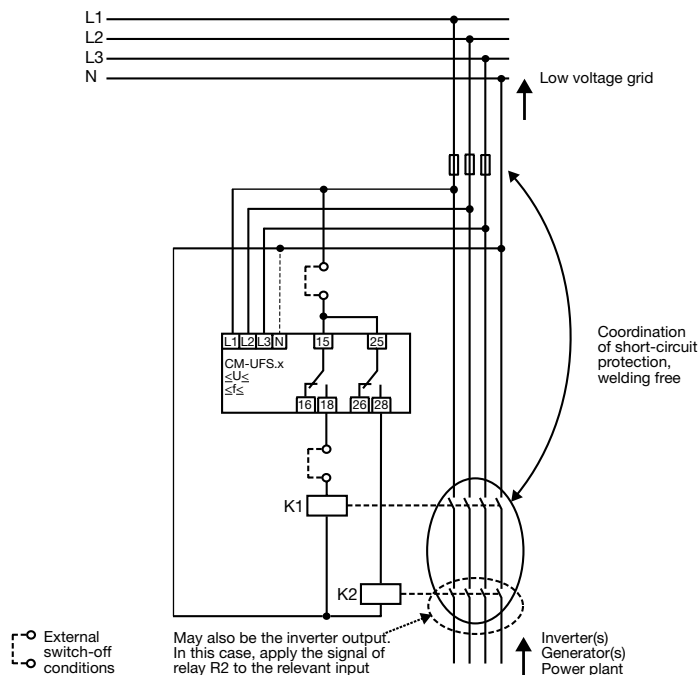

Automatized grid connection instead of a permanently accessible switching point with a disconnection function

## LED Functions

| Function               | R/T:<br>yellow LED | F1:<br>red LED | F2:<br>red LED |
|------------------------|--------------------|----------------|----------------|
| Output relay energized | ■                  | -              | -              |
| Delay active           | ▬▬▬                | -              | -              |
| Overvoltage            | -                  | ■              | -              |
| Undervoltage           | -                  | -              | ■              |
| Overfrequency          | -                  | ▬▬▬            | -              |
| Underfrequency         | -                  | -              | ▬▬▬            |
| Phase failure          | -                  | ▬▬▬            | ▬▬▬            |

# Three-phase monitoring relays

## Connection diagrams, DIP switches

### Connection diagrams CM-PBE

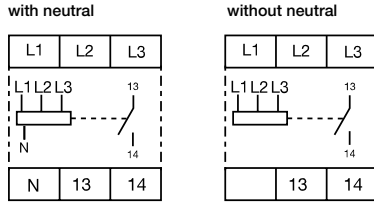

L1, L2, L3, (N) Control supply voltage =  
Measuring voltage  
13-14 Output contact -  
closed-circuit principle

### Connection diagram CM-PVS.x1

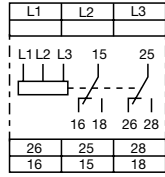

L1, L2, L3 Control supply voltage =  
measuring voltage  
15-16/18 Output contacts -  
25-26/28 closed-circuit principle

### Connection diagram CM-PFS

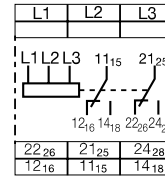

L1-L2-L3 Control supply voltage =  
Measuring voltage  
11<sub>15</sub>-12<sub>16</sub>/14<sub>18</sub> Output contact -  
21<sub>25</sub>-22<sub>26</sub>/24<sub>28</sub> Closed-circuit principle

6

### Rotary switch "Function" CM-PVS

- ON-delay  
with phase sequence monitoring
- OFF-delay  
with phase sequence monitoring
- ON-delay  
without phase sequence monitoring
- OFF-delay  
without phase sequence monitoring

### Connection diagrams CM-PVE

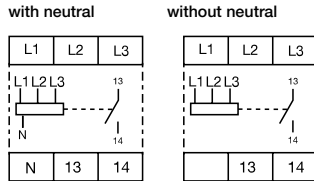

L1, L2, L3, (N) Control supply voltage =  
Measuring voltage  
13-14 Output contact -  
closed-circuit principle

### Connection diagram CM-PSS.x1

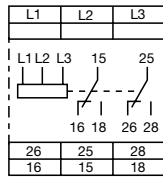

L1, L2, L3 Control supply voltage =  
measuring voltage  
15-16/18 Output contacts -  
25-26/28 closed-circuit principle

### Connection diagram CM-PFE

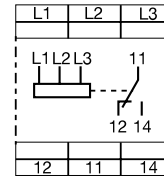

L1-L2-L3 Control supply voltage =  
Measuring voltage  
11-12/14 Output contact  
Closed-circuit principle

### Rotary switch "Function" CM-PSS

- ON-delay  
with phase sequence monitoring
- OFF-delay  
with phase sequence monitoring
- ON-delay  
without phase sequence monitoring
- OFF-delay  
without phase sequence monitoring

### Connection diagram CM-UFS.2

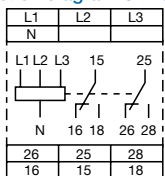

L1, L2, L3, N Control supply voltage =  
Measuring voltage  
15-16/18 Output contacts -  
25-26/28 closed-circuit principle

### Connection diagram CM-MPN.x2

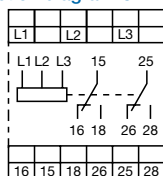

L1, L2, L3 Control supply voltage =  
measuring voltage  
15-16/18 Output contacts -  
25-26/28 closed-circuit principle

### Connection diagram CM-PAS.x1

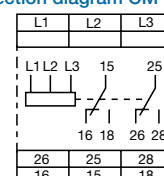

L1, L2, L3 Control supply voltage =  
measuring voltage  
15-16/18 Output contacts -  
25-26/28 closed-circuit principle



# Three-phase monitoring relays

## Connection diagrams, DIP switches, rotary switches

Connection diagram CM-MPS.x3

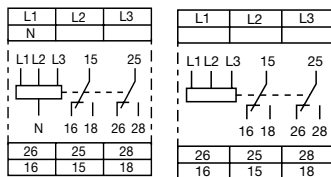

L1, L2, L3, (N) Control supply voltage = measuring voltage  
15-16/18 Output contacts -  
25-26/28 closed-circuit principle

DIP switch functions CM-MPS.x3 and CM-MPN.x2

| Position | 4 | 3       | 2 | 1 |
|----------|---|---------|---|---|
| ON ↑     |   | 2x1 c/o |   |   |
| OFF      |   | 1x2 c/o |   |   |

**1 Timing function**  
ON ON-delayed  
OFF OFF-delayed

**2 Phase sequence monitoring**  
ON deactivated  
OFF activated

**3 Operating principle of output**  
ON 2x1 c/o contact  
OFF 1x2 c/o contacts

**4 Phase sequence correction**  
ON activated  
OFF deactivated

<sup>1)</sup> Output relay R1 is responsive to overvoltage, output relay R2 is responsive to undervoltage. In case of other faults, both output relays react synchronously.

Connection diagram CM-MPS.x1

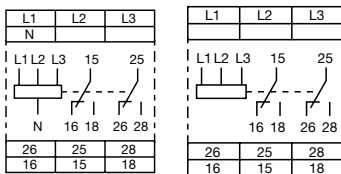

L1, L2, L3, (N) Control supply voltage = measuring voltage  
15-16/18 Output contacts -  
25-26/28 closed-circuit principle

DIP switch functions CM-MPS.x1

| Position | 2 | 1 |
|----------|---|---|
| ON ↑     |   |   |
| OFF      |   |   |

**1 Timing function**  
ON ON-delayed  
OFF OFF-delayed

**2 Phase sequence monitoring**  
ON deactivated  
OFF activated

# Three-phase monitoring relays

## Technical data

Data at  $T_a = 25\text{ °C}$  and rated values, unless otherwise indicated

| Type   | CM-PBE <sup>1)</sup>                               | CM-PBE   | CM-PVE <sup>1)</sup>         | CM-PVE         | CM-PFE          | CM-PFS                                     |
|--|--|--|------------------------------|----------------|-----------------|--|
| <b>Supply circuit = measuring circuit</b>                  | L1-L2-L3-N   | L1-L2-L3   | L1-L2-L3-N                   | L1-L2-L3       | L1-L2-L3        |  |
| Rated control supply voltage $U_s$ = measuring voltage     | 3x380-440 V AC, 220-240 V AC                       | 3x380-440 V AC   | 3x320-460 V AC, 185-265 V AC | 3x320-460 V AC | 3x208-440 V AC  | 3x200-500 V AC                             |
| Power consumption  |  |  |                              |                |                 | approx. 15 VA                              |
| Rated control supply voltage $U_s$ tolerance               | -15...+15 %  |  | -15...+10 %                  |                | -10...+10 %     | -15...+10 %                                |
| Rated frequency  | 50/60 Hz   |  | 50/60 Hz (-10...+10 %)       |                | 50/60 Hz        |  |
| Duty time  | 100 %  |  |                              |                |                 |  |
| Measuring circuit  | L1-L2-L3-N   | L1-L2-L3   | L1-L2-L3-N                   | L1-L2-L3       | L1-L2-L3        |  |
| Monitoring functions                                       | phase failure                                      | ■  | ■                            | ■              | ■               | ■  |
|  | phase sequence                                     | -  | -                            | -              | ■               | ■  |
|  | over / undervoltage                                | -  | -                            | -              | -               | -  |
|  | neutral  | ■  | -                            | ■              | -               | -  |
| Measuring ranges   | 3x380-440 V AC, 220-240 V AC                       | 3x380-440 V AC   | 3x320-460 V AC, 185-265 V AC | 3x320-460 V AC | 3x208-440 V AC  | 3x200-500 V AC                             |
| Thresholds   | $U_{min}$  |  | fixed 185 V / 320 V          | fixed 320 V    | $0.6 \times UN$ |  |
|  | $U_{max}$  |  | fixed 265 V / 460 V          | fixed 460 V    |                 |  |
| Hysteresis related to the threshold value                  | fixed 5 %<br>(release value = $0.65 \times UN$ )   |  | fixed 5 %                    |                |                 |  |
| Measuring voltage frequency                                | 50/60 Hz (-10 %...+10 %)                           |  |                              |                | 50/60 Hz        |  |
| Response time  | 40 ms  |  | 80 ms                        |                | 500 ms          |  |
| Accuracy within the rated control supply voltage tolerance |  |  |                              |                |                 | $\Delta U \leq 0.5\ %$                     |
| Accuracy within the temperature range                      |  |  |                              |                |                 | $\Delta U \leq 0.06\ \% / \text{°C}$       |
| <b>Timing circuit</b>                                      |  |  |                              |                |                 |  |
| Start-up delay $t_s$                                       | fixed 500 ms ( $\pm 20\ %$ )                       |  |                              |                | fixed 500 ms    |  |
| Tripping $t_v$   | fixed 150 ms ( $\pm 20\ %$ )                       | at over- / undervoltage<br>fixed 500 ms ( $\pm 20\ %$ )  |                              |                | fixed 500 ms    | -  |
| <b>Indication of operational states</b>                    |  |  |                              |                |                 |  |
| Relay status   | R: yellow LED                                      |  Output relay energized |                              |                |                 |  |
| <b>Output circuits</b>                                     | 13-14  |  |                              |                | 11-12/14        | 11(15)-12(16)/14(18), 21(25)-22(26)/24(28) |
| Kind of output   | 1 n/o contact                                      |  |                              |                | 1 c/o contact   | 2 c/o contacts                             |
| Operating principle <sup>2)</sup>                          | closed-circuit principle                           |  |                              |                |                 |  |
| Contact material   | AgCdO  |  |                              |                | AgNi            |  |
| Rated operational voltage $U_n$                            | IEC/EN 60947-1                                     |  | 250 V                        |                |                 |  |
| Minimum switching voltage / Minimum switching current      | - / -  |  |                              |                |                 |  |
| Maximum switching voltage                                  | 250 V AC, 250 V DC                                 |  |                              |                |                 |  |
| Rated operational current $I_n$ (IEC/EN 60947-5-1)         | AC12 (resistive) 230 V                             | 4 A  |                              |                |                 |  |
|  | AC15 (inductive) 230 V                             | 3 A  |                              |                |                 |  |
|  | DC12 (resistive) 24 V                              | 4 A  |                              |                |                 |  |
|  | DC13 (inductive) 24 V                              | 2 A  |                              |                |                 |  |
| Mechanical lifetime  | 30 x 10 <sup>6</sup> switching cycles              |  |                              |                |                 |  |
| Electrical lifetime (AC12, 230 V, 4 A)                     | 0.1 x 10 <sup>6</sup> switching cycles             |  |                              |                |                 |  |
| Max. fuse rating to achieve short-circuit protection       | n/c contact  | 10 A fast-acting   |                              |                |                 | 4 A fast-acting                            |
|  | n/o contact  | 10 A fast-acting   |                              |                |                 | 6 A fast-acting                            |
| AC rating (UL 508)   | Utilization category (Control Circuit Rating Code) | B 300  |                              |                |                 |  |
|  | max. rated operational voltage                     | 300 V AC   |                              |                |                 |  |
|  | max. continuous thermal current at B 300           | 5 A  |                              |                |                 |  |
|  | max. making/breaking apparent power at B 300       | 3600/360 VA  |                              |                |                 |  |

<sup>1)</sup> Device with neutral monitoring: The external conductor voltage towards the neutral conductor is measured.

<sup>2)</sup> Closed-circuit principle: Output relay is de-energized if the measured value exceeds/drops below the adjusted threshold.

# Three-phase monitoring relays

## Technical data

Measuring &  
monitoring relays  
CM Range

Data at  $T_a = 25\text{ °C}$  and rated values, unless otherwise indicated

| Type   | CM-PBE <sup>1)</sup>                           | CM-PBE | CM-PVE <sup>1)</sup>                         | CM-PVE | CM-PFE   | CM-PFS  |
|--|--|--------|--|--------|--|---|
| <b>General data</b>  |  |        |  |        |  |   |
| Dimensions (W x H x D)   | 22.5 x 78 x 78.5 mm<br>(0.89 x 3.07 x 3.09 in) |        |  |        |  | 22.5 x 78<br>x 100 mm<br>(0.89 x 3.07<br>x 3.94 in) |
| Weight   | see data sheet                                 |        |  |        |  |   |
| Mounting   | DIN rail (IEC/EN 60715)                        |        |  |        |  |   |
| Mounting position  | any  |        |  |        |  |   |
| Degree of protection   | housing / terminals<br>IP50 / IP20             |        |  |        |  |   |
| <b>Electrical connection</b>   |  |        |  |        |  |   |
| Wire size  | fine-strand with wire end ferrule              |        | 2 x 0.75-1.5 mm <sup>2</sup> (2 x 18-16 AWG) |        | 2 x 0.75-<br>2.5 mm <sup>2</sup><br>(2 x 8-14 AWG) |   |
|  | fine-strand without wire end ferrule           |        | 2 x 1-1.5 mm <sup>2</sup> (2 x 18-16 AWG)    |        |  |   |
|  | rigid  |        | 2 x 0.75-1.5 mm <sup>2</sup> (2 x 18-16 AWG) |        | 2 x 0.5-<br>4 mm <sup>2</sup><br>(2 x 20-12 AWG)   |   |
| Stripping length   | 10 mm (0.39 in)                                |        |  |        |  | 7 mm<br>(0.28 in)                                   |
| Tightening torque  | 0.6-0.8 Nm                                     |        |  |        |  |   |
| <b>Environmental data</b>  |  |        |  |        |  |   |
| Ambient temperature range  | operation / storage                            |        | -20...+60 °C / -40...+85 °C                  |        |  |   |
| Environmental testing (IEC 68-2-30)  | 24 h cycle time, 55 °C, 93 % rel., 96 h        |        |  |        |  |   |
| Operational reliability (IEC 68-2-6)   | 6 g  |        |  |        |  | 4 g   |
| Mechanical resistance (IEC 68-2-6)   | 10 g   |        |  |        |  | 6 g   |
| <b>Isolation data</b>  |  |        |  |        |  |   |
| Rated insulation volt. between supply, measuring and output circuits (VDE 0110, IEC 60947-1) | 400 V  |        |  | 500 V  |  |   |
| Rated impulse withstand voltage $U_{imp}$ between all isolated circuits (VDE 0110, IEC 664)  | 4 kV / 1.2 - 50 μs                             |        |  |        |  |   |
| Test voltage between all isolated circuits   | 2.5 kV, 50 Hz, 1 min.                          |        |  |        |  |   |
| Pollution category (VDE 0110, IEC/EN 60664, IEC 255-5)                                       | 3  |        |  |        |  |   |
| Overvoltage category (VDE 0110, IEC/EN 60664, IEC 255-5)                                     | III  |        |  |        |  |   |
| <b>Standards</b>   |  |        |  |        |  |   |
| Product standard   | IEC 255-6, EN 60255-6                          |        |  |        |  |   |
| Low Voltage Directive  | 2006/95/EC                                     |        |  |        |  |   |
| EMC Directive  | 2004/108/EC                                    |        |  |        |  |   |
| <b>Electromagnetic compatibility</b>   |  |        |  |        |  |   |
| Interference immunity to   | EN 61000-6-2                                   |        |  |        |  |   |
| electrostatic discharge  | IEC/EN 61000-4-2                               |        | Level 3 - 6 kV/ 8 kV                         |        |  |   |
| radiated, radio-frequency, electromagnetic field   | IEC/EN 61000-4-3                               |        | Level 3 - 10 V/m                             |        |  |   |
| electrical fast transient / burst  | IEC/EN 61000-4-4                               |        | Level 3 - 2 kV / 5 kHz                       |        |  |   |
| surge  | IEC/EN 61000-4-5                               |        | Level 4 - 2 kV-L                             |        |  |   |
| conducted disturbances, induced by radio-frequency fields                                    | IEC/EN 61000-4-6                               |        | Level 3 - 10 V                               |        |  |   |
| Interference emission  | EN 61000-6-4                                   |        |  |        |  |   |

<sup>1)</sup> Device with neutral monitoring: The external conductor voltage towards the neutral conductor is measured.

<sup>2)</sup> Closed-circuit principle: Output relay is de-energized if the measured value exceeds/drops below the adjusted threshold.

## Three-phase monitoring relays

### Technical data

Data at  $T_a = 25\text{ °C}$  and rated values, unless otherwise indicated

| Type   | CM-PSS.31                                    | CM-PSS.41                | CM-PVS.31   | CM-PVS.41                                  | CM-PVS.81                | CM-PAS.31                                    | CM-PAS.41                |
|--|--|--------------------------|---|--|--------------------------|--|--------------------------|
| <b>Input circuit = Measuring circuit</b>                   |  |                          |   | L1, L2, L3                                 |                          |  |                          |
| Rated control supply voltage $U_s =$ measuring voltage     | 3x380 V AC                                   | 3x400 V AC               | 3x160-300 V AC  | 3x300-500 V AC                             | 3x200-400 V AC           | 3x160-300 V AC                               | 3x300-500 V AC           |
| Rated control supply voltage $U_s$ tolerance               |  |                          |   | -15...+10 %                                |                          |  |                          |
| Rated frequency  |  |                          |   | 50/60 Hz                                   |                          |  |                          |
| Frequency range  |  |                          |   | 45-65 Hz                                   |                          |  |                          |
| Typical current / power consumption                        | 25 mA / 18 VA (380 V AC)                     | 25 mA / 18 VA (400 V AC) | 25 mA / 10 VA (230 V AC)  | 25 mA / 18 VA (400 V AC)                   | 19 mA / 10 VA (300 V AC) | 25 mA / 10 VA (230 V AC)                     | 25 mA / 18 VA (400 V AC) |
| <b>6 Measuring circuit</b>                                 |  |                          |   | L1, L2, L3                                 |                          |  |                          |
| Monitoring functions                                       |  |                          |   |  |                          |  |                          |
| Phase failure  | ■  | ■                        | ■   | ■  | ■                        | ■  | ■                        |
| Phase sequence   |  |                          | can be switched off   |  |                          | ■  | ■                        |
| Automatic phase sequence correction                        | -  | -                        | -   | -  | -                        | -  | -                        |
| Over- / undervoltage                                       | ■  | ■                        | ■   | ■  | ■                        | -  | -                        |
| Phase unbalance  | -  | -                        | -   | -  | -                        | ■  | ■                        |
| Neutral  | -  | -                        | -   | -  | -                        | -  | -                        |
| Measuring range  |  |                          |   |  |                          |  |                          |
| Overvoltage  | 3x418 V AC                                   | 3x440 V AC               | 3x220-300 V AC  | 3x420-500 V AC                             | 3x300-400 V AC           | -  | -                        |
| Undervoltage   | 3x342 V AC                                   | 3x360 V AC               | 3x160-230 V AC  | 3x300-380 V AC                             | 3x210-300 V AC           | -  | -                        |
| Phase unbalance  | -  | -                        | -   | -  | -                        | 2-25 % of average of phase voltages          |                          |
| Thresholds   |  |                          |   |  |                          |  |                          |
| Overvoltage  |  | fixed                    | adjustable within measuring range                               |  |                          | -  | -                        |
| Undervoltage   |  | fixed                    | adjustable within measuring range                               |  |                          | -  | -                        |
| Phase unbalance (switch-off value)                         | -  | -                        | -   | -  | -                        | adjust. within meas. range                   |                          |
| Hysteresis related to the threshold value                  |  |                          | fixed 5 %   |  |                          | -  | fixed 20 %               |
| Rated frequency of the measuring signal                    |  |                          |   | 50/60 Hz                                   |                          |  |                          |
| Frequency range of the measuring signal                    |  |                          |   | 45-65 Hz                                   |                          |  |                          |
| Maximum measuring cycle time                               |  |                          |   | 100 ms                                     |                          |  |                          |
| Accuracy within the rated control supply voltage tolerance |  |                          |   | $\Delta U \leq 0.5\%$                      |                          |  |                          |
| Accuracy within the temperature range                      |  |                          |   | $\Delta U \leq 0.06\% / \text{°C}$         |                          |  |                          |
| Measuring method   |  |                          |   | True RMS                                   |                          |  |                          |
| <b>Timing circuit</b>                                      |  |                          |   |  |                          |  |                          |
| Start-up delay $t_s$                                       |  |                          |   | fixed 200 ms                               |                          |  |                          |
| Tripping delay $t_v$                                       |  |                          |   | ON- or OFF-delay<br>0; 0.1-30 s adjustable |                          | ON- delay<br>0; 0.1-30 s adjustable          |                          |
| Repeat accuracy (constant parameters)                      | -  | -                        | -   | -  | 1 w 0.2 %                | -  | -                        |
| Accuracy within the rated control supply voltage tolerance |  |                          |   | $\Delta t \leq 0.5\%$                      |                          |  |                          |
| Accuracy within the temperature range                      |  |                          |   | $\Delta t \leq 0.06\% / \text{°C}$         |                          |  |                          |
| Indication of operational states                           |  |                          |   | 1 yellow LED, 2 red LED's                  |                          |  |                          |
|  | Details see function description / -diagrams |                          | Details see operating mode and function description / -diagrams |  |                          | Details see function description / -diagrams |                          |
| <b>Output circuits</b>                                     |  |                          |   |  |                          |  |                          |
| Kind of output   |  |                          |   | 15-16/18, 25-26/28                         |                          |  |                          |
| Operating principle <sup>1)</sup>                          |  |                          |   | 2x1 c/o contacts (Relays)                  |                          |  |                          |
| Contact material   |  |                          |   | closed-circuit principle                   |                          |  |                          |
| Rated operational voltage $U_n$                            | IEC/EN 60947-1                               |                          |   | AgNi alloy, Cd free                        |                          |  |                          |
| Minimum switching power                                    |  |                          |   | 250 V                                      |                          |  |                          |
| Maximum switching voltage                                  |  |                          |   | 24 V / 10 mA                               |                          |  |                          |
|  |  |                          |   | see load limit curve                       |                          |  |                          |

<sup>1)</sup> Closed-circuit principle: Output relay(s) de-energize(s) if measured value exceeds or falls below the adjusted threshold value

# Three-phase monitoring relays

## Technical data

Measuring &  
monitoring relays  
CM Range

Data at  $T_a = 25\text{ °C}$  and rated values, unless otherwise indicated

| Type   | CM-PSS.31   | CM-PSS.41                                   | CM-PVS.31                              | CM-PVS.41                                      | CM-PVS.81                                   | CM-PAS.31 | CM-PAS.41 |  |
|--|---|---|--|--|---|-----------|-----------|--|
| Rated operational current $I_o$<br>(IEC/EN 60947-5-1)              | AC12 (resistive) 230 V  |   |  | 4 A  |   |           |           |  |
|  | AC15 (inductive) 230 V  |   |  | 3 A  |   |           |           |  |
|  | DC12 (resistive) 24 V   |   |  | 4 A  |   |           |           |  |
|  | DC13 (inductive) 24 V   |   |  | 2 A  |   |           |           |  |
|  | Utilization category<br>(Control Circuit Rating Code)         |   |  | B 300  |   |           |           |  |
| AC rating (UL 508)   | max. rated operational voltage                                |   |  | 300 V AC                                       |   |           |           |  |
|  | max. continuous thermal current at B 300                      |   |  | 5 A  |   |           |           |  |
|  | max. making/breaking apparent power at B 300                  |   |  | 3600/360 VA                                    |   |           |           |  |
|  | Mechanical lifetime   |   |  | 30 x 10 <sup>6</sup> switching cycles          |   |           |           |  |
| Electrical lifetime (AC12, 230 V, 4 A)                             |   |   | 0.1 x 10 <sup>6</sup> switching cycles |  |   |           |           |  |
| Max. fuse rating to achieve short-circuit protection               | n/c contact   |   |  | 6 A fast-acting                                |   |           |           |  |
|  | n/o contact   |   |  | 10 A fast-acting                               |   |           |           |  |
| <b>General data <sup>1)</sup></b>                                  |   |   |  |  |   |           |           |  |
| MTBF   | on request  |   |  |  |   |           |           |  |
| Duty time  | 100%  |   |  |  |   |           |           |  |
| Dimensions (W x H x D)   | product dimensions  |   |  | 22.5 x 85.6 x 103.7 mm (0.89 x 3.37 x 4.08 in) |   |           |           |  |
|  | packaging dimensions  |   |  | 97 x 109 x 30 mm (3.82 x 4.29 x 1.18 in)       |   |           |           |  |
| Weight   | depending on device, see ordering details                     |   |  |  |   |           |           |  |
| Mounting   | DIN rail (IEC/EN 60715),<br>snap-on mounting without any tool |   |  |  |   |           |           |  |
|  | any   |   |  |  |   |           |           |  |
| Mounting position  | vertical / horizontal   |   |  |  |   |           |           |  |
| Minimum distance to other units                                    | not necessary / not necessary                                 |   |  |  |   |           |           |  |
| Material of housing  | UL 94 V-0   |   |  |  |   |           |           |  |
| Degree of protection   | housing / terminals   |   |  | IP50 / IP20                                    |   |           |           |  |
| <b>Electrical connection <sup>1)</sup></b>                         |   |   |  |  |   |           |           |  |
| Wire size  | Screw connection technology                                   |   |  | Easy Connect Technology (Push-in)              |   |           |           |  |
|  | fine-strand with(out) wire end ferrule                        | 1 x 0.5-2.5 mm <sup>2</sup> (1 x 20-14 AWG) |  |  | 2 x 0.5-1.5 mm <sup>2</sup> (2 x 20-16 AWG) |           |           |  |
|  |   | 2 x 0.5-1.5 mm <sup>2</sup> (2 x 20-16 AWG) |  |  |   |           |           |  |
| rigid  | 1 x 0.5-4 mm <sup>2</sup> (1 x 20-12 AWG)                     |   |  | 2 x 0.5-1.5 mm <sup>2</sup> (2 x 20-16 AWG)    |   |           |           |  |
| 2 x 0.5-2.5 mm <sup>2</sup> (2 x 20-14 AWG)                        |   |   |  |  |   |           |           |  |
| Stripping length   | 8 mm (0.32 in)  |   |  |  |   |           |           |  |
| Tightening torque  | 0.6-0.8 Nm (5.31-7.08 lb.in)                                  |   |  | -  |   |           |           |  |
| <b>Environmental data</b>  |   |   |  |  |   |           |           |  |
| Ambient temperature ranges   | operation / storage   |   |  | -25...+60 °C / -40...+85 °C                    |   |           |           |  |
| Damp heat (IEC 60068-2-30)   | 55 °C, 6 cycles   |   |  |  |   |           |           |  |
| Climatic category  | 3K3   |   |  |  |   |           |           |  |
| Vibration (sinusoidal) (IEC/EN 60255-21-1)                         | Class 2   |   |  |  |   |           |           |  |
| Shock (IEC/EN 60255-21-2)  | Class 2   |   |  |  |   |           |           |  |
| <b>Isolation data <sup>1)</sup></b>                                |   |   |  |  |   |           |           |  |
| Rated insulation voltage $U_i$                                     | input circuit / output circuit                                |   |  | 600 V  |   |           |           |  |
|  | output circuit 1 / output circuit 2                           |   |  | 300 V  |   |           |           |  |
| Rated impulse withstand voltage $U_{imp}$ (VDE 0110, IEC/EN 60664) | input circuit   |   |  | 6 kV; 1.2/50 µs                                |   |           |           |  |
|  | output circuit  |   |  | 4 kV; 1.2/50 µs                                |   |           |           |  |
| Test voltage between all isolated circuits (type test)             |   |   | 2.5 kV, 50 Hz, 1 s                     |  |   |           |           |  |
| Basis isolation  | input circuit / output circuit                                |   |  | 600 V  |   |           |           |  |
| Protective separation (VDE 0106 part 101 and 101/A, IEC/EN 1140)   | input circuit /   |   |  | -  |   |           |           |  |
|  | output circuit  |   |  |  |   |           |           |  |
| Pollution degree (VDE 0110, IEC/EN 60664)                          | 3   |   |  |  |   |           |           |  |
| Overvoltage category (VDE 0110, IEC 60664)                         | III   |   |  |  |   |           |           |  |
| <b>Standards</b>   |   |   |  |  |   |           |           |  |
| Product standard   | IEC/EN 60255-6, EN 50178                                      |   |  |  |   |           |           |  |
| Low Voltage Directive  | 2006/95/EG  |   |  |  |   |           |           |  |
| EMC directive  | 2004/108/EG   |   |  |  |   |           |           |  |
| RoHS directive   | 2002/95/EG  |   |  |  |   |           |           |  |
| <b>Electromagnetic compatibility</b>                               |   |   |  |  |   |           |           |  |
| Interference immunity to   |   |   | EN 61000-6-1, EN 61000-6-2             |  |   |           |           |  |
| electrostatic discharge  | IEC/EN 61000-4-2  |   |  | Level 3 (6 kV / 8 kV)                          |   |           |           |  |
|  | radiated, radio-frequency, electromagnetic field              |   |  | Level 3 (10 V/m)                               |   |           |           |  |
| electrical fast transient / burst surge                            | IEC/EN 61000-4-4  |   |  | Level 3 (2 kV / 2 kHz)                         |   |           |           |  |
|  | IEC/EN 61000-4-5  |   |  | Level 4 (2 kV L-L)                             |   |           |           |  |
| conducted disturbances, induced by radio-frequency fields          |   |   | Level 3 (10 V)                         |  |   |           |           |  |
| Interference emission  |   |   | Class 3                                |  |   |           |           |  |
| high-frequency radiated  | IEC/CISPR 22, EN 50022  |   |  | EN 61000-6-3, EN 61000-6-4                     |   |           |           |  |
| high-frequency conducted   | IEC/CISPR 22, EN 50022  |   |  | Class B  |   |           |           |  |

<sup>1)</sup> Data for devices 1SVR 730 xxx xxx, 1SVR 740 xxx xxx, 1SVR 750 xxx xxx, 1SVR 760 xxx xxx. For devices 1SVR x30 xxx xxx, 1SVR x50 xxx xxx refer to the data sheet.

## Three-phase monitoring relays

### Technical data

Data at  $T_a = 25\text{ °C}$  and rated values, unless otherwise indicated

| Type   | CM-MPS.11  | CM-MPS.21                           | CM-MPS.31                   | CM-MPS.41                   |
|--|--|-------------------------------------|-----------------------------|-----------------------------|
| <b>Input circuit = Measuring circuit</b>                   | L1, L2, L3, N                                      |                                     | L1, L2, L3                  |                             |
| Rated control supply voltage $U_s$ = measuring voltage     | 3x90-170 V AC                                      | 3x180-280 V AC                      | 3x160-300 V AC              | 3x300-500 V AC              |
| Rated control supply voltage $U_s$ tolerance               | -15...+10 %  |                                     |                             |                             |
| Rated frequency  | 50/60 Hz   |                                     |                             |                             |
| Frequency range  | 45-65 Hz   |                                     |                             |                             |
| Typical current / power consumption                        | 25 mA / 10 VA<br>(115 V AC)                        | 25 mA / 18 VA<br>(230 V AC)         | 25 mA / 10 VA<br>(230 V AC) | 25 mA / 18 VA<br>(400 V AC) |
| <b>6 Measuring circuit</b>                                 | L1, L2, L3, N                                      |                                     | L1, L2, L3                  |                             |
| Monitoring functions                                       | Phase failure                                      | ■                                   | ■                           | ■                           |
|  | Phase sequence                                     | can be switched off                 |                             |                             |
|  | Automatic phase sequence correction                | -                                   | -                           | -                           |
|  | Over- / undervoltage                               | ■                                   | ■                           | ■                           |
|  | Phase unbalance                                    | ■                                   | ■                           | ■                           |
|  | Interrupted neutral                                | ■                                   | -                           | ■                           |
| Measuring range  | Overvoltage  | 3x120-170 V AC                      | 3x240-280 V AC              | 3x220-300 V AC              |
|  | Undervoltage                                       | 3x90-130 V AC                       | 3x180-220 V AC              | 3x160-230 V AC              |
|  | Phase unbalance                                    | 2-25 % of average of phase voltages |                             |                             |
| Thresholds   | Overvoltage  | adjustable within measuring range   |                             |                             |
|  | Undervoltage                                       | adjustable within measuring range   |                             |                             |
|  | Phase unbalance (switch-off value)                 | adjustable within measuring range   |                             |                             |
| Hysteresis related to the threshold value                  | Over- / undervoltage                               | fixed 5 %                           |                             |                             |
|  | Phase unbalance                                    | fixed 20 %                          |                             |                             |
| Rated frequency of the measuring signal                    | 50/60 Hz   |                                     |                             |                             |
| Frequency range of the measuring signal                    | 45-65 Hz   |                                     |                             |                             |
| Maximum measuring cycle time                               | 100 ms   |                                     |                             |                             |
| Accuracy within the rated control supply voltage tolerance | $\Delta U \leq 0.5\%$                              |                                     |                             |                             |
| Accuracy within the temperature range                      | $\Delta U \leq 0.06\% / \text{°C}$                 |                                     |                             |                             |
| Measuring method   | True RMS   |                                     |                             |                             |
| <b>Timing circuit</b>                                      | fixed 200 ms                                       |                                     |                             |                             |
| Start-up delay $t_s$                                       | fixed 200 ms                                       |                                     |                             |                             |
| Tripping delay $t_v$                                       | ON- or OFF-delay 0; 0.1-30 s adjustable            |                                     |                             |                             |
| Accuracy within the rated control supply voltage tolerance | $\Delta t \leq 0.5\%$                              |                                     |                             |                             |
| Accuracy within the temperature range                      | $\Delta t \leq 0.06\% / \text{°C}$                 |                                     |                             |                             |
| Indication of operational states                           | Details see function description / -diagrams       |                                     |                             |                             |
| <b>Output circuits</b>                                     | 15-16/18, 25-26/28                                 |                                     |                             |                             |
| Kind of output   | 1x2 c/o contacts (Relays)                          |                                     |                             |                             |
| Operating principle <sup>1)</sup>                          | closed-circuit principle                           |                                     |                             |                             |
| Contact material   | AgNi alloy, Cd free                                |                                     |                             |                             |
| Rated operational voltage $U_o$ (IEC/EN 60947-1)           | 250 V  |                                     |                             |                             |
| Minimum switching power                                    | 24 V / 10 mA                                       |                                     |                             |                             |
| Maximum switching voltage                                  | see load limit curve                               |                                     |                             |                             |
| Rated operational current $I_o$ (IEC/EN 60947-5-1)         | AC12 (resistive) 230 V                             | 4 A                                 |                             |                             |
|  | AC15 (inductive) 230 V                             | 3 A                                 |                             |                             |
|  | DC12 (resistive) 24 V                              | 4 A                                 |                             |                             |
|  | DC13 (inductive) 24 V                              | 2 A                                 |                             |                             |
| AC rating (UL 508)   | Utilization category (Control Circuit Rating Code) | B 300                               |                             |                             |
|  | max. rated operational voltage                     | 300 V AC                            |                             |                             |
|  | max. continuous thermal current at B 300           | 5 A                                 |                             |                             |
|  | max. making/breaking apparent power at B 300       | 3600/360 VA                         |                             |                             |
| Mechanical lifetime  | 30 x 10 <sup>6</sup> switching cycles              |                                     |                             |                             |
| Electrical lifetime (AC12, 230 V, 4 A)                     | 0,1 x 10 <sup>6</sup> switching cycles             |                                     |                             |                             |
| Max. fuse rating to achieve short-circuit protection       | n/c contact  | 6 A fast-acting                     |                             |                             |
|  | n/o contact  | 10 A fast-acting                    |                             |                             |

# Three-phase monitoring relays

## Technical data

Data at  $T_a = 25\text{ °C}$  and rated values, unless otherwise indicated

| Type   | CM-MPS.11  | CM-MPS.21  | CM-MPS.31                                   | CM-MPS.41 |
|--|--|--|---|-----------|
| <b>General data <sup>2)</sup></b>                                  |  |  |   |           |
| MTBF   | on request   |  |   |           |
| Duty time  | 100%   |  |   |           |
| Dimensions   | product dimensions   | 22.5 x 85.6 x 103.7 mm (0.89 x 3.37 x 4.08 in)   |   |           |
|  | packaging dimensions                                       | 97 x 109 x 30 mm (3.82 x 4.29 x 1.18 in)   |   |           |
| (W x H x D)  |  |  |   |           |
| Weight   | Screw connection technology                                | Easy Connect Technology (Push-in)  |   |           |
|  | net weight   | depending on device, see ordering details  |   |           |
|  | gross weight   | depending on device, see ordering details  |   |           |
| Mounting   | DIN rail (IEC/EN 60715), snap-on mounting without any tool |  |   |           |
| Mounting position  | any  |  |   |           |
| Minimum distance to other units                                    | vertical / horizontal                                      | not necessary / not necessary  |   |           |
| Material of housing  | UL 94 V-0  |  |   |           |
| Degree of protection   | housing / terminals  | IP50 / IP20  |   |           |
| <b>Electrical connection <sup>2)</sup></b>                         |  |  |   |           |
| Wire size  |  | Screw connection technology  | Easy Connect Technology (Push-in)           |           |
|  | fine-strand with(out) wire end ferrule                     | 1 x 0.5-2.5 mm <sup>2</sup> (1 x 20-14 AWG)<br>2 x 0.5-1.5 mm <sup>2</sup> (2 x 20-16 AWG) | 2 x 0.5-1.5 mm <sup>2</sup> (2 x 20-16 AWG) |           |
|  | rigid  | 1 x 0.5-4 mm <sup>2</sup> (1 x 20-12 AWG)<br>2 x 0.5-2.5 mm <sup>2</sup> (2 x 20-14 AWG)   | 2 x 0.5-1.5 mm <sup>2</sup> (2 x 20-16 AWG) |           |
| Stripping length   | 8 mm (0.32 in)   |  |   |           |
| Tightening torque  | 0.6-0.8 Nm (5.31-7.08 lb.in)                               |  | -   |           |
| <b>Environmental data</b>  |  |  |   |           |
| Ambient temperature ranges   | operation / storage  | -25...+60 °C / -40...+85 °C  |   |           |
| Damp heat (IEC 60068-2-30)   | 55 °C, 6 cycles  |  |   |           |
| Climatic category  | 3K3  |  |   |           |
| Vibration (sinusoidal) (IEC/EN 60255-21-1)                         | Class 2  |  |   |           |
| Shock (IEC/EN 60255-21-2)  | Class 2  |  |   |           |
| <b>Isolation data <sup>2)</sup></b>                                |  |  |   |           |
| Rated insulation voltage $U_i$                                     | input circuit / output circuit                             | 600 V  |   |           |
|  | output circuit 1 / output circuit 2                        | 300 V  |   |           |
| Rated impulse withstand voltage $U_{imp}$ (VDE 0110, IEC/EN 60664) | input circuit  | 6 kV; 1.2/50 $\mu$ s   |   |           |
|  | output circuit   | 4 kV; 1.2/50 $\mu$ s   |   |           |
| Test voltage between all isolated circuits (type test)             | 2.5 kV, 50 Hz, 1 s   |  |   |           |
| Basis isolation  | input circuit / output circuit                             | 600 V  |   |           |
| Protective separation (VDE 0106 part 101 and 101/A, IEC/EN 61140)  | input circuit / output circuit                             | yes  | -   |           |
| Pollution degree (VDE 0110, IEC/EN 60664)                          | 3  |  |   |           |
| Overvoltage category (VDE 0110, IEC 60664)                         | III  |  |   |           |
| <b>Standards <sup>2)</sup></b>                                     |  |  |   |           |
| Product standard   | IEC/EN 60255-6, EN 50178                                   |  |   |           |
| Low Voltage Directive  | 2006/95/EG   |  |   |           |
| EMC directive  | 2004/108/EG  |  |   |           |
| RoHS directive   | 2002/95/EG   |  |   |           |
| <b>Electromagnetic compatibility</b>                               |  |  |   |           |
| Interference immunity to   | EN 61000-6-1, EN 61000-6-2                                 |  |   |           |
| electrostatic discharge  | IEC/EN 61000-4-2   | Level 3 (6 kV / 8 kV)  |   |           |
| radiated, radio-frequency, electromagnetic field                   | IEC/EN 61000-4-3   | Level 3 (10 V/m)   |   |           |
| electrical fast transient / burst                                  | IEC/EN 61000-4-4   | Level 3 (2 kV / 2 kHz)   |   |           |
| surge  | IEC/EN 61000-4-5   | Level 4 (2 kV L-L)   |   |           |
| conducted disturbances, induced by radio-frequency fields          | IEC/EN 61000-4-6   | Level 3 (10 V)   |   |           |
| harmonics and interharmonics                                       | IEC/EN 61000-4-13  | Class 3  |   |           |
| Interference emission  | EN 61000-6-3, EN 61000-6-4                                 |  |   |           |
| high-frequency radiated  | IEC/CISPR 22, EN 50022                                     | Class B  |   |           |
| high-frequency conducted   | IEC/CISPR 22, EN 50022                                     | Class B  |   |           |

<sup>1)</sup> Closed-circuit principle: Output relay(s) de-energize(s) if measured value exceeds or falls below the adjusted threshold value

<sup>2)</sup> Data for devices 1SVR 730 xxx xxx, 1SVR 740 xxx xxx, 1SVR 750 xxx xxx, 1SVR 760 xxx xxx. For devices 1SVR x30 xxx xxx, 1SVR x50 xxx xxx refer to the data sheet.

# Three-phase monitoring relays

## Technical data

Data at  $T_a = 25\text{ °C}$  and rated values, unless otherwise indicated

| Type   | CM-MPS.23   | CM-MPS.43        | CM-MPN.52  | CM-MPN.62                   | CM-MPN.72                   |
|--|---|------------------|--|-----------------------------|-----------------------------|
| <b>Input circuit = Measuring circuit</b>                   |   |                  |  |                             |                             |
| Rated control supply voltage $U_s$ = measuring voltage     | L1, L2, L3, N<br>3x180-280 V AC                                     | 3x300-500 V AC   | L1, L2, L3<br>3x350-580 V AC   3x450-720 V AC   3x530-820 V AC |                             |                             |
| Rated control supply voltage $U_s$ tolerance               | -15...+10 %   |                  |  |                             |                             |
| Rated frequency  | 50/60/400 Hz<br>45-440 Hz   |                  | 50/60 Hz<br>45-65 Hz   |                             |                             |
| Frequency range  | 5 mA / 4 VA<br>(230 V AC)   |                  | 5 mA / 4 VA<br>(400 V AC)                                      | 29 mA / 41 VA<br>(480 V AC) | 29 mA / 52 VA<br>(600 V AC) |
| Typical current / power consumption                        |   |                  | 29 mA / 59 VA<br>(690 V AC)                                    |                             |                             |
| <b>6 Measuring circuit</b>                                 |   |                  |  |                             |                             |
| Monitoring functions                                       | L1, L2, L3, N   | L1, L2, L3       |  |                             |                             |
| Phase failure  | ■   | ■                | ■  | ■                           | ■                           |
| Phase sequence   | can be switched off   |                  |  |                             |                             |
| Automatic phase sequence correction                        | configurable  |                  |  |                             |                             |
| Over- / undervoltage                                       | ■   | ■                | ■  | ■                           | ■                           |
| Phase unbalance  | ■   | ■                | ■  | ■                           | ■                           |
| Interrupted neutral  | ■   | -                | -  | -                           | -                           |
| Measuring range  |   |                  |  |                             |                             |
| Overvoltage  | 3x240-280 V AC  | 3x420-500 V AC   | 3x480-580 V AC   | 3x600-720 V AC              | 3x690-820 V AC              |
| Undervoltage   | 3x180-220 V AC  | 3x300-380 V AC   | 3x350-460 V AC   | 3x450-570 V AC              | 3x530-660 V AC              |
| Phase unbalance  | 2-25 % of average of phase voltages                                 |                  |  |                             |                             |
| Overvoltage  | adjustable within measuring range                                   |                  |  |                             |                             |
| Undervoltage   | adjustable within measuring range                                   |                  |  |                             |                             |
| Phase unbalance (switch-off value)                         | adjustable within measuring range                                   |                  |  |                             |                             |
| Hysteresis related to the threshold value                  | fixed 5 %   |                  |  |                             |                             |
| Over- / undervoltage                                       | fixed 20 %  |                  |  |                             |                             |
| Phase unbalance  |   |                  |  |                             |                             |
| Rated frequency of the measuring signal                    | 50/60/400 Hz  |                  | 50/60 Hz   |                             |                             |
| Frequency range of the measuring signal                    | 45-440 Hz   |                  | 45-65 Hz   |                             |                             |
| Maximum measuring cycle time                               | 100 ms  |                  |  |                             |                             |
| Accuracy within the rated control supply voltage tolerance | $\Delta U \leq 0.5\%$   |                  |  |                             |                             |
| Accuracy within the temperature range                      | $\Delta U \leq 0.06\% / \text{°C}$                                  |                  |  |                             |                             |
| Measuring method   | True RMS  |                  |  |                             |                             |
| <b>Timing circuit</b>                                      |   |                  |  |                             |                             |
| Start-up delay $t_s$ and $t_{s2}$                          | fixed 200 ms  |                  |  |                             |                             |
| Start-up delay $t_{s1}$                                    | fixed 250 ms  |                  |  |                             |                             |
| Tripping delay $t_v$                                       | ON- or OFF-delay<br>0; 0.1-30 s adjustable                          |                  | ON-delay<br>0; 0.1-30 s adjustable                             |                             |                             |
| Accuracy within the rated control supply voltage tolerance | $\Delta t \leq 0.5\%$   |                  |  |                             |                             |
| Accuracy within the temperature range                      | $\Delta t \leq 0.06\% / \text{°C}$                                  |                  |  |                             |                             |
| Indication of operational states                           | Details see function description / -diagrams                        |                  |  |                             |                             |
| <b>Output circuits</b>                                     |   |                  |  |                             |                             |
| Kind of output   | 15-16/18, 25-26/28<br>2x1 or 1x2 c/o contacts configurable (Relays) |                  |  |                             |                             |
| Operating principle <sup>1)</sup>                          | closed-circuit principle  |                  |  |                             |                             |
| Contact material   | AgNi alloy, Cd free   |                  |  |                             |                             |
| Rated operational voltage $U_o$                            | IEC/EN 60947-1<br>250 V   |                  |  |                             |                             |
| Minimum switching power                                    | 24 V / 10 mA  |                  |  |                             |                             |
| Maximum switching voltage                                  | see load limit curve  |                  |  |                             |                             |
| Rated operational current $I_o$<br>(IEC/EN 60947-5-1)      | AC12 (resistive) 230 V  | 4 A              |  |                             |                             |
|  | AC15 (inductive) 230 V  | 3 A              |  |                             |                             |
|  | DC12 (resistive) 24 V   | 4 A              |  |                             |                             |
|  | DC13 (inductive) 24 V   | 2 A              |  |                             |                             |
| AC rating<br>(UL 508)                                      | Utilization category (Control Circuit Rating Code)                  | B 300            |  |                             |                             |
|  | max. rated operational voltage                                      | 300 V AC         |  |                             |                             |
|  | max. continuous thermal current at B 300                            | 5 A              |  |                             |                             |
|  | max. making/breaking apparent power at B 300                        | 3600/360 VA      |  |                             |                             |
| Mechanical lifetime  | 30 x 10 <sup>6</sup> switching cycles                               |                  |  |                             |                             |
| Electrical lifetime (AC12, 230 V, 4 A)                     | 0,1 x 10 <sup>6</sup> switching cycles                              |                  |  |                             |                             |
| Max. fuse rating to achieve short-circuit protection       | n/c contact   | 6 A fast-acting  | 10 A fast-acting   |                             |                             |
|  | n/o contact   | 10 A fast-acting |  |                             |                             |

<sup>1)</sup> Closed-circuit principle: Output relay(s) de-energize(s) if measured value exceeds or falls below the adjusted threshold value



# Three-phase monitoring relays

## Technical data

Data at  $T_a = 25\text{ °C}$  and rated values, unless otherwise indicated

| Type   | CM-MPS.23  | CM-MPS.43                                      | CM-MPN.52                       | CM-MPN.62                         | CM-MPN.72                       |
|--|--|--|---------------------------------|-----------------------------------|---------------------------------|
| <b>General data <sup>2)</sup></b>                                  |  |  |                                 |                                   |                                 |
| MTBF   | on request   |  |                                 |                                   |                                 |
| Duty time  | 100%   |  |                                 |                                   |                                 |
| Dimensions (W x H x D)   | product dimensions   | 22.5 x 85.6 x 103.7 mm (0.89 x 3.37 x 4.08 in) |                                 |                                   |                                 |
|  | packaging dimensions                                       | 97 x 109 x 30 mm (3.82 x 4.29 x 1.18 in)       |                                 |                                   |                                 |
| Weight   | depending on device, see ordering details                  |  |                                 |                                   |                                 |
| Mounting   | DIN rail (IEC/EN 60715), snap-on mounting without any tool |  |                                 |                                   |                                 |
| Mounting position  | any  |  |                                 |                                   |                                 |
| Minimum distance to other units                                    | vertical / horizontal                                      | not necessary / not necessary                  |                                 |                                   |                                 |
| Material of housing  | UL 94 V-0  |  |                                 |                                   |                                 |
| Degree of protection   | housing / terminals  | IP50 / IP20                                    |                                 |                                   |                                 |
| <b>Electrical connection <sup>2)</sup></b>                         |  |  |                                 |                                   |                                 |
| Wire size  | fine-strand with(out) wire end ferrule                     | Screw connection technology                    |                                 | Easy Connect Technology (Push-in) |                                 |
|  |  | 1 x 0.5-2.5 mm2 (1 x 20-14 AWG)                | 2 x 0.5-1.5 mm2 (2 x 20-16 AWG) | 2 x 0.5-1.5 mm2 (2 x 20-16 AWG)   | 2 x 0.5-1.5 mm2 (2 x 20-16 AWG) |
|  | rigid  | 1 x 0.5-4 mm2 (1 x 20-12 AWG)                  | 2 x 0.5-2.5 mm2 (2 x 20-14 AWG) | 2 x 0.5-1.5 mm2 (2 x 20-16 AWG)   | 2 x 0.5-1.5 mm2 (2 x 20-16 AWG) |
| Stripping length   | 8 mm (0.32 in)   |  |                                 |                                   |                                 |
| Tightening torque  | 0.6-0.8 Nm (5.31-7.08 lb.in)                               |  |                                 |                                   |                                 |
| <b>Environmental data</b>  |  |  |                                 |                                   |                                 |
| Ambient temperature ranges   | operation / storage  | -25...+60 °C / -40...+85 °C                    |                                 |                                   |                                 |
| Damp heat (IEC 60068-2-30)   | 55 °C, 6 cycles  |  |                                 |                                   |                                 |
| Climatic category  | 3K3  |  |                                 |                                   |                                 |
| Vibration (sinusoidal) (IEC/EN 60255-21-1)                         | Class 2  |  |                                 |                                   |                                 |
| Shock (IEC/EN 60255-21-2)  | Class 2  |  |                                 |                                   |                                 |
| <b>Isolation data <sup>2)</sup></b>                                |  |  |                                 |                                   |                                 |
| Rated insulation voltage $U_i$                                     | input circuit / output circuit                             | 600 V  | 1000 V                          |                                   |                                 |
|  | output circuit 1 / 2                                       | 300 V  |                                 |                                   |                                 |
| Rated impulse withstand voltage $U_{imp}$ (VDE 0110, IEC/EN 60664) | input circuit  | 6 kV; 1.2/50 $\mu$ s                           | 8 kV; 1.2/50 $\mu$ s            |                                   |                                 |
|  | output circuit   | 4 kV; 1.2/50 $\mu$ s                           |                                 |                                   |                                 |
| Test voltage (type test) between                                   | isolated output circuits                                   | 2.5 kV, 50 Hz, 1 s                             |                                 |                                   |                                 |
|  | input circuit and isolated output circuits                 | 2.5 kV, 50 Hz, 1 s                             | 4 kV, 50 Hz, 1 s                |                                   |                                 |
| Basis isolation  | input circuit / output circuit                             | 600 V  | 1000 V                          |                                   |                                 |
| Protective separation (VDE 0106 part 101 and 101/A, IEC/EN 61140)  | input circuit / output circuit                             | -  |                                 |                                   |                                 |
| Pollution degree (VDE 0110, IEC/EN 60664)                          | 3  |  |                                 |                                   |                                 |
| Overvoltage category (VDE 0110, IEC 60664)                         | III  |  |                                 |                                   |                                 |
| <b>Standards <sup>2)</sup></b>                                     |  |  |                                 |                                   |                                 |
| Product standard   | IEC/EN 60255-6, EN 50178                                   |  |                                 |                                   |                                 |
| Low Voltage Directive  | 2006/95/EG   |  |                                 |                                   |                                 |
| EMC directive  | 2004/108/EG  |  |                                 |                                   |                                 |
| RoHS directive   | 2002/95/EG   |  |                                 |                                   |                                 |
| <b>Electromagnetic compatibility</b>                               |  |  |                                 |                                   |                                 |
| Interference immunity to   |  | EN 61000-6-1, EN 61000-6-2                     |                                 |                                   |                                 |
| electrostatic discharge  | IEC/EN 61000-4-2   | Level 3 (6 kV / 8 kV)                          |                                 |                                   |                                 |
| radiated, radio-frequency, electromagnetic field                   | IEC/EN 61000-4-3   | Level 3 (10 V/m)                               |                                 |                                   |                                 |
| electrical fast transient / burst                                  | IEC/EN 61000-4-4   | Level 3 (2 kV / 2 kHz)                         |                                 |                                   |                                 |
| surge  | IEC/EN 61000-4-5   | Level 4 (2 kV L-N)                             | Level 4 (2 kV L-L)              |                                   |                                 |
| conducted disturbances, induced by radio-frequency fields          | IEC/EN 61000-4-6   | Level 3 (10 V)                                 |                                 |                                   |                                 |
| harmonics and interharmonics                                       | IEC/EN 61000-4-13  | Class 3  |                                 |                                   |                                 |
| Interference emission  |  | EN 61000-6-3, EN 61000-6-4                     |                                 |                                   |                                 |
| high-frequency radiated  | IEC/CISPR 22, EN 50022                                     | Class B  |                                 |                                   |                                 |
| high-frequency conducted   | IEC/CISPR 22, EN 50022                                     | Class B  |                                 |                                   |                                 |

<sup>2)</sup> Data for devices 1SVR 730 xxx xxx, 1SVR 740 xxx xxx, 1SVR 750 xxx xxx, 1SVR 760 xxx xxx. For devices 1SVR x30 xxx xxx, 1SVR x50 xxx xxx refer to the data sheet.

## Three-phase monitoring relays

### Technical data

Data at  $T_a = 25\text{ °C}$  and rated values, unless otherwise indicated

| Type   | CM-UFS.2  |                             |
|--|---|-----------------------------|
| <b>Input circuit - Measuring circuit</b>   | L1, L2, L3  | L-N                         |
| Rated control supply voltage $U_s =$ measuring voltage   | 3 x 400 V AC  | 3 x 230 V AC                |
| Rated control supply voltage tolerance $U_s$   | -20...+20 %   |                             |
| Control supply voltage range   | 3 x 300-500 V AC  | 3 x 180-280 V AC            |
| Rated frequency  | 50 Hz   |                             |
| Frequency range  | 45-55 Hz  |                             |
| Typical current / power consumption  | 23 mA / 16 VA   |                             |
| Power failure buffering time   | min. 20 ms  |                             |
| <b>6 Input circuit - measuring circuit</b>   | L1, L2, L3  | L-N                         |
| Monitoring functions   | <ul style="list-style-type: none"> <li>Phase failure</li> <li>Over-/ undervoltage</li> <li>Over-/ underfrequency</li> <li>10 minutes average value</li> </ul> |                             |
| Measuring range  | Voltage range<br>3 x 320-480 V AC   | 3 x 184-276 V AC            |
| Thresholds   | Frequency range   | 45-55 Hz                    |
|  | Overvoltage   | fix, 120 % of $U_s$         |
|  | Undervoltage  | fix, 80 % of $U_s$          |
|  | Overfrequency   | 50,3 or 51 Hz, configurable |
|  | Underfrequency  | 49,7 or 49 Hz, configurable |
| Hysteresis related to the threshold value  | Over-/ undervoltage   | fix 5 %                     |
|  | Over-/ underfrequency   | fix 20 mHz                  |
| Rated frequency of the measuring signal  | 50 Hz   |                             |
| Frequency range of the measuring signal  | 45-55 Hz  |                             |
| Maximum measuring cycle time   | 50 ms   |                             |
| Maximum reaction time (time between fault detection and change of switching status of the relay) | Over-/ undervoltage   | < 120 ms                    |
|  | Over-/ underfrequency   | < 100 ms                    |
| 10 minutes average value   | -   |                             |
| Accuracy within the rated control supply voltage tolerance                                       | $\Delta U \leq 0,5\%$   |                             |
| Accuracy within the temperature range  | $\Delta U \leq 0,06\% / \text{°C}$  |                             |
| Measuring method   | True RMS  |                             |
| <b>Timing circuit</b>  |   |                             |
| Start-up delay $t_{s1}$ prior to grid connection after a short interruption                      | fix, 1 s  |                             |
| Restart delay $t_{s2}$   | adjustable, 0 s; 0,1 – 30 s   |                             |
| Accuracy within the rated control supply voltage tolerance                                       | $\Delta t \leq 0,5\%$   |                             |
| Accuracy within the temperature range  | $\Delta t \leq 0,06\% / \text{°C}$  |                             |
| <b>Indication of operational states</b>  | 1 yellow LED, 2 red LEDs<br>Details see operation mode and function description/diagrams  |                             |
| <b>Output circuits</b>   | 15-16/18, 25-26/28  |                             |
| Kind of output   | Relais, 1 x 2 changeover  |                             |
| Operation principle <sup>1)</sup>  | closed-circuit principle  |                             |
| Contact material   | AgNi alloy, Cd free   |                             |
| Rated operational voltage $U_o$ (IEC/EN 60947-1)   | 250 V   |                             |
| Minimum switching voltage / switching current  | 24 V / 10 mA  |                             |
| Maximum switching voltage / switching current  | see load limit curve  |                             |
| Rated operational current $I_o$ (IEC/EN 60947-5-1)   | AC12 (resistive) 230 V  | 4 A                         |
|  | AC15 (inductive) 230 V  | 3 A                         |
|  | DC12 (resistive) 24 V   | 4 A                         |
|  | DC13 (inductive) 24 V   | 2 A                         |
| Mechanical lifetime  | 30 x 10 <sup>6</sup> switching cycles   |                             |
| Electrical lifetime (AC12, 230 V, 4 A)   | 0,1 x 10 <sup>6</sup> switching cycles  |                             |
| Max. fuse rating to achieve short-circuit protection   | n/c contact   | 6 A fast-acting             |
|  | n/o contact   | 10 A fast-acting            |

# Three-phase monitoring relays

## Technical data

Data at  $T_a = 25\text{ °C}$  and rated values, unless otherwise indicated

| Type   |   | CM-UFS.2   |
|--|---|--|
| <b>General data</b>  |   |  |
| MTBF   |   | on request   |
| Duty time  |   | 100%   |
| Dimensions (W x H x D)   | product dimensions  | 22.5 x 78 x 100 mm (0.89 x 3.07 x 3.94 in)                 |
| Weight   | gross weight  | 0.140 (0.31)   |
| Mounting   |   | DIN rail (IEC/EN 60715), snap-on mounting without any tool |
| Mounting position  |   | any  |
| Minimum distance to other units                                    | vertical / horizontal   | not necessary / not necessary                              |
| Degree of protection   | housing / terminals   | IP50 / IP20  |
| <b>Electrical connection</b>                                       |   |  |
| Wire size  | fine-strand with(out) wire end ferrule  | 2 x 0.75 - 2.5 mm <sup>2</sup> (2 x 18-14 AWG)             |
|  | rigid   | 2 x 0.5 - 4 mm <sup>2</sup> (2 x 20-12 AWG)                |
| Stripping length   |   | 7 mm (0.28 in)   |
| Tightening torque  |   | 0.6-0.8 Nm (5.31-7.08 lb.in)                               |
| <b>Environmental data</b>  |   |  |
| Ambient temperature range  | operation / storage   | -25...+60 °C / -40...+85 °C                                |
| Damp heat, cyclic (IEC/EN 60068-2-30)                              |   | 2 x 12 h cycle, 55 °C, 95 % RH                             |
| Climatic category (IEC/EN 60721-3-1)                               |   | 3K3  |
| Vibration (sinusoidal) (IEC/EN 60255-21-1)                         |   | Class 2  |
| Shock (IEC/EN 60255-21-2)  |   | Class 2  |
| <b>Isolation data</b>  |   |  |
| Rated impulse withstand voltage $U_i$                              | input circuit / output circuit  | 600 V  |
|  | output circuit 1 / 2  | 300 V  |
| Rated impulse withstand voltage $U_{imp}$ (VDE 0110, IEC/EN 60664) | input circuit   | 6 kV; 1.2/50 $\mu$ s                                       |
|  | output circuit  | 4 kV; 1.2/50 $\mu$ s                                       |
| Test voltage between all isolated circuits (type test)             |   | 2.5 kV, 50 Hz, 1 s   |
| Basis isolation  | input circuit / output circuit  | 600 V  |
| Protective separation (VDE 0160 Part 101 and 101/A, IEC/EN 61140)  | input circuit / output circuit  | yes  |
| Pollution degree (VDE 0110, IEC/EN 60664)                          |   | 3  |
| Overvoltage category (VDE 0110, IEC 60664)                         |   | III  |
| <b>Standards</b>   |   |  |
| Product standard   | Type-tested in accordance with "Guideline for Connections to ENEL distribution network" Ed.2.1., January 2011 |  |
| Further standards  | EN 50178, EN 61727  |  |
| Low Voltage Directive  | 2006/95/EG  |  |
| EMV-Directive  | 2004/108/EG   |  |
| RoHS-Directive   | 2002/95/EG  |  |
| <b>Electromagnetic compatibility</b>                               |   |  |
| Interference immunity to   | IEC/EN 61000-6-1, IEC/EN 61000-6-2  |  |
| electrostatic discharge  | IEC/EN 61000-4-2  | Level 3 (6 kV / 8 kV)                                      |
| radiated, radio-frequency, electromagnetic field                   | IEC/EN 61000-4-3  | Level 3 (10 V/m)   |
| electrical fast transient / burst                                  | IEC/EN 61000-4-4  | Level 3 (2 kV / 2 kHz)                                     |
| surge  | IEC/EN 61000-4-5  | Level 4 (2 kV L-L, L-N)                                    |
| conducted disturbances, induced by radio-frequency fields          | IEC/EN 61000-4-6  | Level 3 (10 V)   |
| harmonics and interharmonics                                       | IEC/EN 61000-4-13   | Class 3  |
| Interference emission  | IEC/EN 61000-6-3, IEC/EN 61000-6-4  |  |
| high-frequency radiated  | IEC/CISPR 22, EN 50022  | Class B  |
| high-frequency conducted   | IEC/CISPR 22, EN 50022  | Class B  |

<sup>1)</sup> Closed-circuit principle: Output relay(s) de-energize(s) if measured value exceeds or falls below the adjusted threshold value

## Notes



Insulation monitoring relays  
for unearthed supply systems

# CM-E Range Insulation monitoring relays



## Insulation monitoring relays for unearthed supply systems

### Benefits and advantages

6



#### Insulation monitoring relays for unearthed pure AC systems: Characteristics

- For monitoring the insulation resistance of unearthed IT system: up to  $U_n = 400$  V AC
- According to IEC/EN 61227-8 "Electrical safety in low voltage distribution systems up to 1000 V AC and 1500 V DC – Equipment for testing, measuring or monitoring of protective measures – Part 8: Insulation monitoring devices for IT systems"
- Rated control supply voltage 24–240 V AC/DC
- Superimposed DC signal
- One measuring range 1–100 kW
- Precise adjustment of the threshold value in 1 kW steps
- Interrupted wire detection
- Fault storage/latching configurable by control input
- 1 c/o contact, closed-circuit principle
- 22.5 mm [0.89 in] width
- 3 LEDs for status indication

#### A new generation of insulation monitoring relays of the CM range consolidates ABB's strengths in innovative control products.

The new products are in accordance to IEC/EN 61557-1 and to IEC/EN 61557-8. That means the monitoring relays can be used directly to measure the insulation resistance in unearthed AC and DC mains with a voltage up to 690 V AC and 1000 V DC!

With the new prognostic measuring principle the measuring and response time is reduced significantly.

#### Insulation monitoring relays for unearthed AC, DC or mixed AC/DC systems: Characteristics

- For monitoring the insulation resistance of unearthed IT systems up to  $U_n = 250$  V AC and 300 V DC or  $U_n = 400$  V AC and 600 V DC
- According to IEC/EN 61227-8 "Electrical safety in low voltage distribution systems up to 1000 V AC and 1500 V DC – Equipment for testing, measuring or monitoring of protective measures – Part 8: Insulation monitoring devices for IT systems"
- Rated control supply voltage 24–240 V AC/DC
- Prognostic measuring principle with superimposed square wave signal
- 1 or 2 measuring ranges (1-100kW or 1-100 kW + 2-200 kOhm)<sup>1)</sup>
- 1 or 2 (configurable) c/o contacts<sup>1)</sup>
- Precise adjustment of the measuring value in 1 or 2 kW steps<sup>1)</sup>
- (non-volatile) fault storage, configurable latching, interrupted wire protection, open- or closed-circuit principle selectable<sup>1)</sup>
- 22.5 or 45 mm width
- 3 LEDs for status indication
- Solution for solar available

<sup>1)</sup> depending on device

#### Standardization background:

- IEC/EN 61557-1 "Electrical safety in low voltage distribution system up to 1000 V AC and 1500 V DC – Equipment for testing, measuring or monitoring of protective measures – Part 1: General requirements"
- IEC/EN 61557-8 "Electrical safety in low voltage distribution system up to 1000 V AC and 1500 V DC – Equipment for testing, measuring or monitoring of protective measures – Part 1: Insulation monitoring devices for IT systems"

# Insulation monitoring relays for unearthed supply systems

## Insulation monitoring in IT systems

In electricity supply systems, an earthing system defines the electrical potential of the conductors relative to that of the earth's conductive surface. The choice of earthing system has implications for the safety and electromagnetic compatibility of the power supply. Note that regulations for earthing (grounding) systems vary considerably among different countries.

The international standard IEC 60364 distinguishes three families of earthing arrangements, using the two-letter codes TN, TT and IT.

### IT supply systems

The IT system is supplied either by an isolation transformer or a voltage source, such as battery or a generator. In this system no active conductor is directly connected to earth potential. The advantage of this is that only a small fault current can flow in case of an insulation fault. This current is essentially caused by the system's leakage capacitance. The system's fuse or MCB does not respond, thus maintaining the voltage supply and therefore operation even in case of a phase-to-earth fault.

The first letter indicates the connection between earth and the power-supply equipment (generator or transformer):

- T: direct connection of a point with earth (Latin: terra)
- I: no point is connected with earth (insulation), except perhaps via a high impedance

The second letter indicates the connection between earth and the electrical device being supplied:

- T: direct connection of a point with earth
- N: direct connection to neutral at the origin of installation, which is connected to the earth

The high reliability of an IT system is guaranteed thanks to continuous insulation monitoring.

The insulation monitoring device recognizes insulation faults as they develop, and immediately reports that the value has fallen below the minimum. This prevents operational interruptions caused by a second more severe insulation fault.

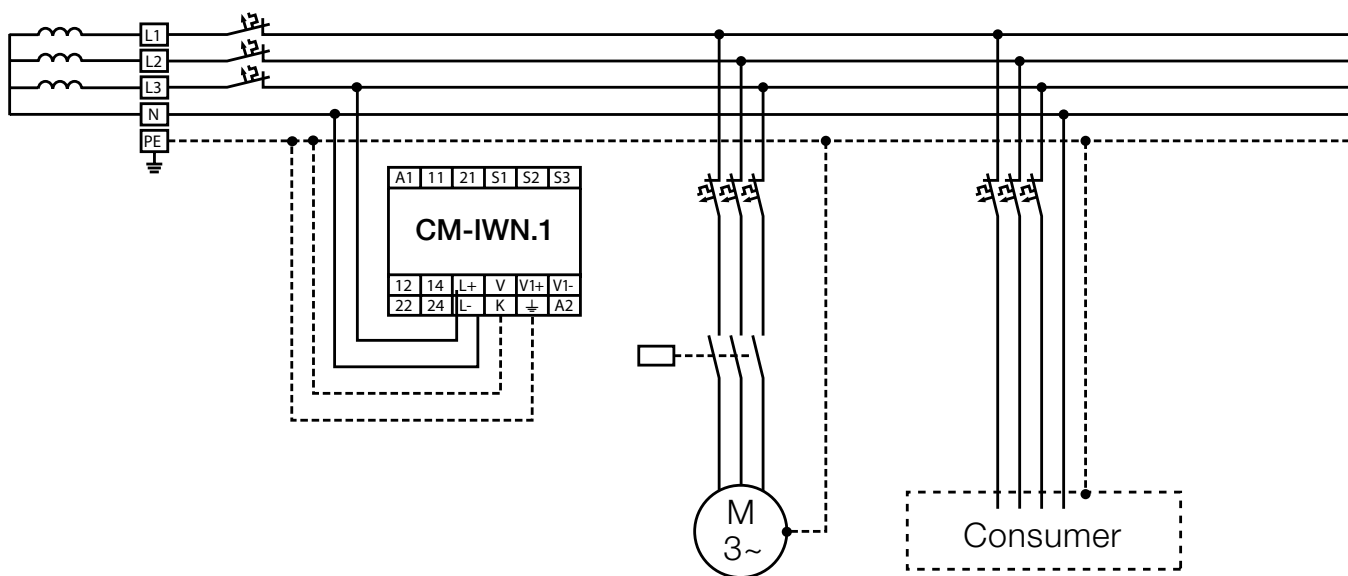

# Insulation monitoring relays for unearthed supply systems

## Application / monitoring function, measuring principle

### Application / monitoring function CM-IWS.2

The CM-IWS.2 serves to monitor insulation resistance in accordance with IEC 61557-8 in unearthed IT AC systems. The insulation resistance between system lines and system earth is measured. If this falls below the adjustable threshold values, the output relay de-energizes. The device can monitor control circuits (single-phase) and main circuits (3-phase). Supply systems with voltages  $U_n = 0-400$  V AC (45-65 Hz) can be directly connected to the measuring inputs and their insulation resistance being monitored. For systems with voltages above 400 V AC the insulation monitoring relay CM-IWN.1 with or without the coupling unit CM-IVN can be used.

6

### Application / monitoring function CM-IWS.1

The CM-IWS.1 serves to monitor insulation resistance in accordance with IEC 61557-8 in unearthed IT AC systems, IT AC systems with galvanically connected DC circuits, or unearthed IT DC systems. The insulation resistance between system lines and system earth is measured. If this falls below the adjustable threshold value, the output relay de-energizes. The device can monitor control circuits (single-phase) and main circuits (3-phase). Supply systems with voltages  $U_n = 0-250$  V AC (15-400 Hz) or 0-300 V DC can be directly connected to the measuring inputs and their insulation resistance being monitored. For systems with voltages above 250 V AC and 300 V DC the insulation monitoring relay CM-IWN.x with or without the coupling unit CM-IVN can be used.

### Application / monitoring function CM-IWN.1 / CM-IWN.5

The CM-IWN.x serves to monitor insulation resistance in accordance with IEC 61557-8 in unearthed IT AC systems, IT AC systems with galvanically connected DC circuits, or unearthed IT DC systems. The insulation resistance between system lines and system earth is measured. If this falls below the adjustable threshold values, the output relays switch into the fault state. The device can monitor control circuits (single-phase) and main circuits (3-phase). Supply systems with voltages  $U_n = 0-400$  V AC (15-400 Hz) or 0-600 V DC can be directly connected to the measuring inputs and their insulation resistance being monitored. For systems with voltages above 400 V AC and 600 V DC the coupling unit CM-IVN can be used for the expansion of the CM-IWN.x voltage range.

### Application / monitoring function CM-IVN

The coupling unit CM-IVN is designed to extend the nominal voltage range of the insulation monitoring relay CM-IWN.1 up to 690 V AC and 1000 V DC. The coupling unit can be connected to the system to be monitored by means of the terminals VL+ and VL-. The terminal  $V_{\perp}$  has to be connected to the earth potential. The terminals L+, V1+, L-, V1-, VS and VE have to be connected to the CM-IWN.1 as shown in the connection diagrams below. Supply systems with voltages  $U_n = 0-690$  V AC (15-400 Hz) or 0-1000 V DC can be connected.

### Measuring principle CM-IWS.2

A superimposed DC measuring signal is used for measurement. From the superimposed DC measuring voltage and its resultant current the value of the insulation resistance of the system to be monitored is calculated.

### Measuring principle CM-IWS.1

A pulsating measuring signal is fed into the system to be monitored and the insulation resistance calculated. This pulsating measuring signal alters its form depending on the insulation resistance and system leakage capacitance. From this altered form the change in the insulation resistance is forecast. When the forecast insulation resistance corresponds to the insulation resistance calculated in the next measurement cycle and is smaller than the set threshold value, the output relay de-energizes. This measuring principle is also suitable for the detection of symmetrical insulation faults.

### Measuring principle CM-IWN.1 / CM-IWN.5

A pulsating measuring signal is fed into the system to be monitored and the insulation resistance calculated.

This pulsating measuring signal alters its form depending on the insulation resistance and system leakage capacitance. From this altered form the change in the insulation resistance is forecast. When the forecast insulation resistance corresponds to the insulation resistance calculated in the next measurement cycle and is smaller than the set threshold value, the output relays are activated or deactivated, depending on the device configuration. This measuring principle is also suitable for the detection of symmetrical insulation faults.

### Measuring principle CM-IVN

With CM-IWN.1 a pulsating measuring signal is fed into the system to be monitored and the insulation resistance calculated. This pulsating measuring signal alters its form depending on the insulation resistance and system leakage capacitance. From this altered form the change in the insulation resistance is forecast. When the forecast insulation resistance corresponds to the insulation resistance calculated in the next measurement cycle and is smaller than the set threshold value, the output relays are activated or deactivated, depending on the device configuration. This measuring principle is also suitable for the detection of symmetrical insulation faults.



### Characteristics CM-IWS.2

- For monitoring the insulation resistance of unearthed IT systems up to  $U_n = 400$  V AC
- Rated control supply voltage 24-240 V AC/DC
- Measuring principle with superimposed DC voltage
- One measuring range 1-100 k $\Omega$
- Precise adjustment of the threshold value in 1 k $\Omega$  steps
- Fault storage / latching configurable by control input
- 1 c/o contact, closed-circuit principle
- 22.5 mm [0.89 in] width
- 3 LEDs for status indication

### Characteristics CM-IWS.1

- For monitoring the insulation resistance of unearthed IT systems up to  $U_n = 250$  V AC and 300 V DC
- Rated control supply voltage 24-240 V AC/DC
- Prognostic measuring principle with superimposed square wave signal
- One measuring range 1-100 k $\Omega$
- Precise adjustment of the threshold value in 1 k $\Omega$  steps
- Interrupted wire detection
- Fault storage / latching configurable by control input
- 1 c/o [SPDT] contact, closed-circuit principle
- 22.5 mm [0.89 in] width
- 3 LEDs for status indication

### Characteristics CM-IWN.1, CM-IWN.5

- For monitoring the insulation resistance of unearthed IT systems up to  $U_n = 400$  V AC and 600 V DC
- CM-IWN.5: According to IEC/EN 61557-8 "Electrical safety in low voltage distribution systems up to 1000 V a.c. and 1500 V d.c. – Equipment for testing, measuring or monitoring of protective measures – Part 8: Insulation monitoring devices for IT systems"
- Rated control supply voltage 24-240 V AC/DC
- Prognostic measuring principle with superimposed square wave signal
- Two measuring ranges 1-100 k $\Omega$  and 2-200 k $\Omega$
- One (1 x 2 c/o) or two (2 x 1 c/o) threshold values  $R_{an1}/R1^{1)}$  (final switch-off) and  $R_{an2}/R21$  (prewarning) configurable<sup>2)</sup>
- Precise adjustment of the threshold values in 1 k $\Omega$  steps (R1) and 2 k $\Omega$  steps (R2)
- Interrupted wire detection configurable
- Non-volatile fault storage configurable
- Open- or closed-circuit principle configurable
- 45 mm (1.77 in) width
- 3 LEDs for status indication

<sup>1)</sup> term. acc. to IEC/EN 61557-8

<sup>2)</sup> R2 only active with 2 x 1 c/o configuration

### Characteristics CM-IVN

- Expansion of the nominal voltage range of the insulation monitoring relay CM-IWN.1 for monitoring the insulation resistance of unearthed IT systems up to 690 V AC and 1000 V DC
- According to IEC/EN 61557-8 "Electrical safety in low voltage distribution systems up to 1000 V AC and 1500 V DC – Equipment for testing, measuring or monitoring of protective measures – Part 8: Insulation monitoring devices for IT systems"
- Passive device, no supply voltage needed
- 45 mm [1.77 in] width

# Insulation monitoring relays for unearthed supply systems

## Selection and conversion table



6

Typical applications

Benefits of ABB's new range of insulation monitoring relays:

- Extended measuring voltage range AC and DC
- All devices with wide supply voltage range
- Reduced number of references
- Optimized solutions for solar applications

|  | Reference code | Catalog number             |
|--|----------------|----------------------------|
|  | CM-IWS.2       | 1SVR630670R0200            |
|  | CM-IWS.1       | 1SVR630660R0100            |
|  | CM-IWN.1       | 1SVR650660R0200            |
|  | CM-IWN.4       | 1SVR650660R0300            |
|  | CM-IWN.5       | 1SVR650660R0400            |
|  | CM-IWN.6       | 1SVR650660R0500            |
|  | CM-IVN         | 1SVR650669R9400            |
| <b>Rated control supply voltage <math>U_c</math></b> |                |                            |
| 24 - 240 VAC/DC                                      | ■              | ■                          |
| <b>Measuring voltages</b>                            |                |                            |
| 250 V AC (L-PE)                                      |                | ■                          |
| 400 V AC (L-PE)                                      | ■              | ■                          |
| 690 V AC   |                | ■                          |
| 300 V DC (L-PE)                                      |                | ■                          |
| 600 V DC (L-PE)                                      |                | ■                          |
| 1000 V DC  |                | ■                          |
| <b>Measuring range</b>                               |                |                            |
| 1 - 100 k $\Omega$                                   | ■              | ■                          |
| 2 - 200 k $\Omega$                                   |                | ■                          |
| <b>Output contacts</b>                               |                |                            |
| 1 c/o  | ■              | ■                          |
| 1 x 2 c/o or 2 x 1 c/o                               |                | ■                          |
| <b>Working principle</b>                             |                |                            |
| open circuit principle                               | ■              | ■                          |
| open or closed principle adjustable                  |                | ■                          |
| <b>Test</b>  |                |                            |
| Front face button or control input                   |                | ■                          |
| <b>Reset</b>   |                |                            |
| Front face button or control input                   |                | ■                          |
| Fault storage / latching configurable                | ■              | ■                          |
| Non voltage storage configurable                     |                | ■                          |
| Interrupted wire detection                           |                | ■                          |
| Threshold values configurable                        | 1              | 1 2 2 2 2                  |
| <b>System leakage capacitance, max.</b>              |                |                            |
| 10 $\mu$ F   | ■              | ■                          |
| 20 $\mu$ F   |                | ■                          |
| 500 $\mu$ F  |                | ■                          |
| 1000 $\mu$ F   |                | ■                          |
| 2000 $\mu$ F   |                | ■                          |
| <b>Coupling unit</b>                                 |                |                            |
|  |                | Yes Yes Yes Yes CM-IWN.1-6 |

# Insulation monitoring relays for unearthed supply systems

## Ordering details

Measuring & monitoring relays  
CM Range

NEW



CM-IWS.2

### Description

The high reliability of an IT system is guaranteed thanks to continuous insulation monitoring. An insulation monitoring device recognizes insulation faults as they develop, and immediately reports that the value has fallen below the minimum. This prevents operational interruption caused by a second, more severe insulation fault.

ABB developed a totally new range of insulation monitors for AC, DC or mixed AC/DC IT Systems up to 690 V AC or 1000 V DC. With only 4 devices most standard applications can be served. Additionally a version for solar applications with increased earth leakage capacitance has been added.



CM-IWS.1



CM-IWN.1



CM-IVN

### Ordering details

| Rated control supply voltage = measuring voltage | Nominal voltage $U_n$ of the distribution system to be monitored | System leakage capacitance, max. | Adjustment range of the specified response value $R_{an}$ (threshold) | Reference code | Catalog number  | Weight (1 pce) kg (lb) |
|--|--|----------------------------------|---|----------------|-----------------|------------------------|
| 24-240 V AC/DC                                   | 0-250 V AC / 0-300 V DC  | 10 $\mu$ F                       | 1-100 kW  | CM-IWS.1       | 1SVR630660R0100 | 0.133 (0.293)          |
| 24-240 V AC/DC                                   | 0-400 V AC   | 10 $\mu$ F                       | 1-100 kW  | CM-IWS.2       | 1SVR630670R0200 | 0.127 (0.280)          |
| 24-240 V AC/DC                                   | 0-400 V AC / 0-600 V DC  | 20 $\mu$ F                       | 1-100 kW<br>2-200 kW  | CM-IWN.1       | 1SVR650660R0200 | 0.231 (0.509)          |
| 24-240 V AC/DC                                   | 0-400 V AC / 0-600 V DC  | 1000 $\mu$ F                     | (activated / de-activated by DIP-switch)                              | CM-IWN.5       | 1SVR650660R0400 | 0.231 (0.509)          |
| Passive device, no control supply voltage needed | 0-690 V AC / 0-1000 V DC   |                                  |   | CM-IVN         | 1SVR650669R9400 | 0.169 (0.373)          |

### Ordering details - New range available at 4th quarter of 2012

| Rated control supply voltage = measuring voltage | Nominal voltage $U_n$ of the distribution system to be monitored | System leakage capacitance, max. | Adjustment range of the specified response value $R_{an}$ (threshold) | Reference code | Catalog number  | Weight (1 pce) kg (lb) |
|--|--|----------------------------------|---|----------------|-----------------|------------------------|
| 24-240 V AC/DC                                   | 0-250 V AC / 0-300 V DC  | 10 $\mu$ F                       | 1-100 k $\Omega$  | CM-IWS.1S      | 1SVR730660R0100 | 0.148 (0.326)          |
|  |  |                                  |   | CM-IWS.1P      | 1SVR740660R0100 | 0.137 (0.302)          |
| 24-240 V AC/DC                                   | 0-400 V AC   | 10 $\mu$ F                       | 1-100 k $\Omega$  | CM-IWS.2S      | 1SVR730670R0200 | 0.141 (0.311)          |
|  |  |                                  |   | CM-IWS.2P      | 1SVR740670R0200 | 0.130 (0.287)          |
| 24-240 V AC/DC                                   | 0-400 V AC / 0-600 V DC  | 20 $\mu$ F                       | 1-100 k $\Omega$<br>2-200 k $\Omega$                                  | CM-IWN.1S      | 1SVR750660R0200 | 0.241 (0.531)          |
|  |  |                                  |   | CM-IWN.1P      | 1SVR760660R0200 | .217 (0.478)           |
| 24-240 V AC/DC                                   | 0-400 V AC / 0-600 V DC  | 500 $\mu$                        | (activated / de-activated by DIPswitch)                               | CM-IWN.4S      | 1SVR750660R0300 | 0.241 (0.531)          |
|  |  |                                  |   | CM-IWN.4P      | 1SVR760660R0300 | 0.217 (0.478)          |
| 24-240 V AC/DC                                   | 0-400 V AC / 0-600 V DC  | 1000 $\mu$ F                     |   | CM-IWN.5S      | 1SVR750660R0400 | 0.241 (0.531)          |
|  |  |                                  |   | CM-IWN.5P      | 1SVR760660R0400 | 0.217 (0.478)          |
| 24-240 V AC/DC                                   | 0-400 V AC / 0-600 V DC  | 2000 $\mu$ F                     |   | CM-IWN.6S      | 1SVR760660R0500 | 0.241 (0.531)          |
|  |  |                                  |   | CM-IWN.6P      | 1SVR760660R0500 | 0.217 (0.478)          |

# Insulation monitoring relays for unearthed supply systems

## Operating state indication

### LEDs, status information and fault messages CM-IWS.2

| Operational state                          | LED U (green) | LED F (red)   | LED R (yellow) |
|--|---------------|---------------|----------------|
| Start-up                                   |               | OFF           | OFF            |
| No fault                                   |               | OFF           |                |
| Insulation fault (below threshold value)   |               |               | OFF            |
| Invalid measuring result                   |               |               | OFF            |
| Internal system fault                      | OFF           |               | OFF            |
| Test function                              |               | OFF           | OFF            |
| No fault after fault storage <sup>1)</sup> |               | <sup>2)</sup> |                |

1) The device has triggered after an insulation fault. The fault has been stored and the insulation resistance has returned to a higher value than the threshold value plus hysteresis.

2) Depending on the fault.

6

### LEDs, status information and fault messages CM-IWS.1

| Operational state  | LED U (green) | LED F (red)   | LED R (yellow) |
|--|---------------|---------------|----------------|
| Start-up   |               | OFF           | OFF            |
| No fault   |               | OFF           |                |
| Insulation fault (below threshold value)                         |               |               | OFF            |
| KE/⊥ wire interruption   |               |               | OFF            |
| System leakage capacitance too high / invalid measurement result |               |               | OFF            |
| Internal system fault  | OFF           |               | OFF            |
| Test function  |               | OFF           | OFF            |
| No fault after fault storage <sup>1)</sup>                       |               | <sup>2)</sup> |                |

1) The device has triggered after an insulation fault. The fault has been stored and the insulation resistance has returned to a higher value than the threshold value plus hysteresis.

2) Depending on the fault.

### LEDs, status information and fault messages CM-IWN.1, CM-IWN.5

| Operational state  | LED U (green) | LED F (red)   | LED R (yellow) |
|--|---------------|---------------|----------------|
| Start-up   |               | OFF           | OFF            |
| No fault   |               | OFF           | <sup>1)</sup>  |
| Prewarning   |               |               |                |
| Insulation fault (below threshold value)                         |               |               | <sup>1)</sup>  |
| KE/⊥ wire interruption   |               |               | <sup>1)</sup>  |
| L+/L- wire interruption during system start-up / test function   | /             |               | <sup>1)</sup>  |
| System leakage capacitance too high / invalid measurement result |               |               | <sup>1)</sup>  |
| Internal system fault  | <sup>1)</sup> |               | <sup>1)</sup>  |
| Setting fault <sup>2)</sup>                                      |               |               |                |
| Test function  |               | OFF           | <sup>1)</sup>  |
| No fault after fault storage <sup>3)</sup>                       |               | <sup>4)</sup> |                |

1) Depending on the configuration

2) Possible faulty setting: The threshold value for final switch-off is set at a higher value than the threshold value for prewarning.

3) The device has triggered after an insulation fault. The fault has been stored and the insulation resistance has returned to a higher value than the threshold value plus hysteresis.

4) Depending on the fault

# Insulation monitoring relays for unearthed supply systems

## Connection diagrams, DIP switches

Measuring & monitoring relays  
CM Range

Connection diagram CM-IWS.2

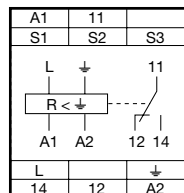

- A1-A2 Control supply voltage
- S1-S3 Remote test
- S2-S3 Remote reset
- L Measuring circuit/input, system connection
- ↓ Measuring circuit/input, earth connections
- 11-12/14 Output relay, closed-circuit principle

Connection diagram CM-IWS.1

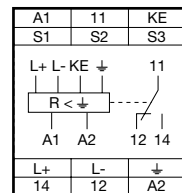

- A1-A2 Control supply voltage
- S1-S3 Remote test
- S2-S3 Remote reset
- L+, L- Measuring circuit/input, system connection
- ↓, KE Measuring circuit/input, earth connections
- 11-12/14 Output relay, closed-circuit principle

Connection diagram CM-IWN.1

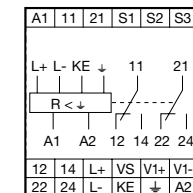

- A1-A2 Control supply voltage
- S1-S3 Remote test
- S2-S3 Remote reset
- L+, L-, ↓, KE Measuring circuit/input, system connection
- VS, V1+, V1- Measuring circuit/input, earth connections
- 11-12/14 Connections for the coupling unit (if used)
- 21-22/24 Output relay 1, open- or closed-circuit principle
- Output relay 2, open- or closed-circuit principle

### DIP switches of IWN.1

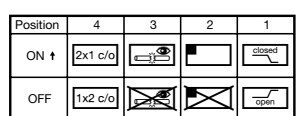

|  | ON   | OFF (default)  |
|--|--|--|
| <b>DIP switch 1</b>                      | Closed-circuit principle <input type="checkbox"/>  | Open-circuit principle <input type="checkbox"/>  |
| Operating principle of the output relays | If closed-circuit principle is selected, the output relays de-energize in case a fault is occurring. In non-fault state the relays are energized.  | If open-circuit principle is selected, the output relays energize in case a fault is occurring. In non-fault state the relays are de-energized.  |
| <b>DIP switch 2</b>                      | Fault storage activated (latching) <input type="checkbox"/>  | Fault storage de-activated (non latching) <input checked="" type="checkbox"/>  |
| Non-volatile fault storage               | If the fault storage function is activated, the output relays remain in tripped position until a reset is done either by the front-face button or by the remote reset connection S2-S3. This function is non-volatile. | If the fault storage function is de-activated, the output relays switch back to their original position as soon as the insulation fault no longer exists.  |
| <b>DIP switch 3</b>                      | Interrupted wire detection activated <input checked="" type="checkbox"/>   | Interrupted wire detection de-activated <input type="checkbox"/> With this configuration the interrupted wire detection is de-activated.   |
| Interrupted wire detection               | With this configuration, the CM-IWN.1 monitoring relays the wires connected to + and KE for interruptions.   |  |
| <b>DIP switch 4</b>                      | 2 x 1 c/o (SPDT) contact <input checked="" type="checkbox"/>   | 1 x 2 c/o (SPDT) contacts <input type="checkbox"/>   |
| 2 x 1 c/o, 1 x 2 c/o                     | If operating principle 2 x 1 c/o contact is selected, the output relay R1 (11-12/14) reacts to threshold value R1 (final switch-off) and the output relay R2 (21-22/24) reacts to threshold value R2 (prewarning)      | If operating principle 1 x 2 c/o contacts is selected, both output relays R1 (11-12/14) and R2 (21-22/24) react synchronously to threshold value R1. Settings of the threshold value R2 have no effect on the operation. |

### Connection diagram CM-IVN

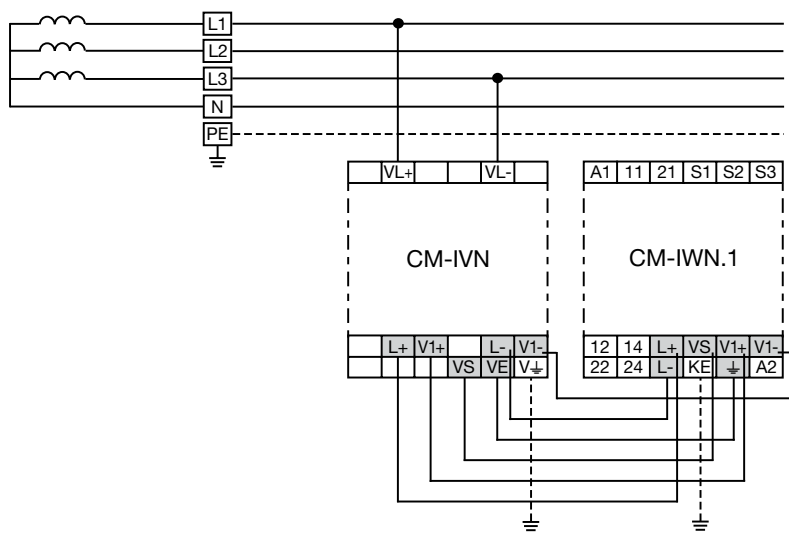

- VE Connection to CM-IWN.1 - ↓
- VS Connection to CM-IWN.1 - VS
- L+ Connection to CM-IWN.1 - L+
- V1+ Connection to CM-IWN.1 - V1+
- L- Connection to CM-IWN.1 - L-
- V1- Connection to CM-IWN.1 - V1-
- VL+, VL- Measuring circuit / Measuring input  
Connection to the system
- V↓ Measuring circuit / Measuring input  
Connection to earth

# Insulation monitoring relays for unearthed supply systems

## Technical data

Data at  $T_a = 25\text{ °C}$  and rated values, unless otherwise indicated

|   | CM-IWS.2   | CM-IWS.1   | CM-IWN.1,4,5,6  |
|---|--|--|---|
| <b>Input circuit - Supply circuit</b>   |  |  |   |
| Rated control supply voltage $U_c$  | A1 - A2<br>24-240 V AC/DC  |  |   |
| Rated control supply voltage tolerance  | -15...+10 %  |  |   |
| Typical current / power consumption   | 24 V DC<br>115 V AC<br>230 V AC  | 30 mA / 0.7 VA<br>12 mA / 1.4 VA<br>12 mA / 2.8 VA                     | 35 mA / 0.9 VA<br>17 mA / 2.0 VA<br>14 mA / 3.2 VA                |
|   |  |  | 55 mA / 1.3 VA<br>20 mA / 2.3 VA<br>15 mA / 3.5 VA                |
| Rated frequency $f_n$   | DC or 15-400 Hz  |  |   |
| Frequency range AC  | 13.5-440 Hz  |  |   |
| Power failure buffering time  | min.   | 20 ms  |   |
| <b>Input circuit - Measuring circuit</b>  |  |  |   |
| Monitoring function   | L, ↓   | L+, L-, ↓, KE  | L+, L-, ↓, KE   |
| Measuring principle   | insulation resistance monitoring of IT systems (IEC/EN 61557-8)<br>superimposed DC voltage | prognostic measuring principle with<br>superimposed square wave signal |   |
| Nominal voltage $U_n$ of the distribution system to be monitored                        | 0-400 V AC   | 0-250 V AC /<br>0-300 V DC   | 400 V AC /<br>0-600 V DC  |
| Voltage range of the distribution system to be monitored                                | 0-460 V AC<br>(tolerance +15 %)  | 0-287.5 V AC /<br>0-345 V DC<br>(tolerance +15 %)                      | 0-460 V AC /<br>0-690 V DC<br>(tolerance +15 %)                   |
| Rated frequency $f_n$ of the distribution system to be monitored                        | 50-60 Hz   | DC or 15-400 Hz  | DC or 15-400 Hz   |
| System leakage capacitance $C_e$  | max.   | 10 $\mu$ F   | CM-IWN.1 20 $\mu$ F<br>CM-IWN.5 1000 $\mu$ F                      |
| Tolerance of the rated frequency $f_n$  | 45-65 Hz   | 13.5-440 Hz  | 13.5-440 Hz   |
| Extraneous DC voltage $U_{dc}$ (when connected to an AC system)                         | max.   | none   | 290 V DC<br>460 V DC  |
| Number of possible response / threshold values  |  | 1  | 2   |
| Adjustment range of the specified response value $R_{an}$ (threshold)                   | min.-max.  | 1-100 k $\Omega$   | -   |
|   | min.-max. R1   | -  | 1-100 k $\Omega$  |
|   | min.-max. R2   | -  | 2-200 k $\Omega$<br>(activated / de-acti-<br>vated by DIP-switch) |
| Adjustment resolution   |  | 1 k $\Omega$   |   |
|   | R1   | 1 k $\Omega$   | 1 k $\Omega$  |
|   | R2   | -  | 2 k $\Omega$  |
| Tolerance of the adjusted threshold value /<br>Relative percentage uncertainty A        | at 1-10 kW $R_{an}$  | $\pm 0.5$ k $\Omega$   | -   |
| at -5...+45 °C, $U_n = 0-115$ %, $U_s = 85-110$ %, $f_n = 15-400$ Hz, $C_e = 1$ $\mu$ F | at 10-100 kW $R_{an}$  | $\pm 6$ %  | -   |
|   | at 1-15 kW $R_{an}$  | -  | $\pm 1$ k $\Omega$ *  |
|   | at 15-200 kW $R_{an}$  | -  | $\pm 8$ %   |
| Hysteresis related to the threshold value   |  | 25 %; min. 2 k $\Omega$  |   |
| Internal impedance Z  | at 50 Hz   | 135 k $\Omega$   | 100 k $\Omega$  |
| Internal DC resistance R  |  | 185 k $\Omega$   | 185 k $\Omega$  |
| Measuring voltage $U_m$   |  | 15 V   | 22 V  |
| Tolerance of measuring voltage $U_m$  |  |  | +10 %   |
| Measuring current $I_m$   | max.   | 0.1 mA   | 0.3 mA  |
| Response time $t_{an}$  |  |  | 0.15 mA   |
| pure AC system  | 0.5 x $R_{an}$ and $C_e = 1$ $\mu$ F   |  | max. 10 s   |
| DC system or AC system with connected rectifiers  |  | -  | max. 15 s   |
| Repeat accuracy (constant parameters)   |  |  | < 0.1 % of full scale   |
| Accuracy of $R_a$ (measured value) within the rated<br>control supply voltage tolerance |  |  | < 0.05 % of full scale  |
| Accuracy of $R_a$ (measured value) within<br>the operation temperature range            | at 1-10 kW $R_{an}$  |  | 5 W / K   |
|   | at 10-100 kW $R_{an}$  | 0.05 % / K   | -   |
|   | at 10-200 kW $R_{an}$  | -  | 0.05 % / K  |
| Transient over voltage protection ( $\frac{1}{2}$ - terminal)                           |  | Z-diode  | avalanche diode   |
| <b>Input circuit - Control circuits</b>   |  |  |   |
| Control inputs - volt free  | S1-S3<br>S2-S3   |  | S1 - S2 - S3<br>remote test<br>remote reset                       |
| Maximum switching current in the control circuit  |  |  | 1 mA  |
| Maximum cable length to the control inputs  |  |  | 50 m - 100 pF/m [164 ft - 30.5 pF/ft]                             |
| Minimum control pulse length  |  |  | 150 ms  |
| No-load voltage at the control input  |  | $\leq 24$ V $\pm 5$ %  | $\leq 24$ V DC  |
| <b>Indication of operational states</b>   |  |  |   |
| Control supply voltage  |  |  | LED U (green)*  |
| Fault message   |  |  | LED F (red)*  |
| Relay status  |  |  | LED R (yellow)*   |

\*in combination with CM-IWN  $\pm 1.5$  k $\Omega$

# Insulation monitoring relays for unearthed supply systems

## Technical data

Measuring & monitoring relays  
CM Range

|   | CM-IWS.2   | CM-IWS.1   | CM-IWN.1,4,5,6   |
|---|--|--|--|
| <b>Output circuits</b>  |  |  |  |
| Kind of output  | relay, 1 c/o (SPDT) contact                        |  | 2 x 1 or 1 x 2 c/o (SPDT) contacts configurable              |
| Operating principle   | closed-circuit principle <sup>1)</sup>             |  | open- or closed circuit principle <sup>1)</sup> configurable |
| Contact material  | AgNi alloy, Cd free                                |  |  |
| Rated voltage (VDE 0110, IEC 60947-1)                         | 250 V AC / 300 V DC                                |  |  |
| Min. switching voltage / Min. switching current               | 24 V / 10 mA                                       |  |  |
| Max. switching voltage / Max. switching current               | see data sheet                                     |  |  |
| Rated operational current I <sub>o</sub> (IEC/EN 60947-5-1)   | AC12 (resistive) at 230 V                          | 4 A  |  |
|   | AC15 (inductive) at 230 V                          | 3 A  |  |
|   | DC12 (resistive) at 24 V                           | 4 A  |  |
|   | DC13 (inductive) at 24 V                           | 2 A  |  |
| AC rating (UL 508)  | Utilization category (Control Circuit Rating Code) | B 300, pilot duty general purpose (250 V, 4 A, cos φ 0.75) |  |
|   | max. rated operational voltage                     | 250 V AC   |  |
|   | max. continuous thermal current at B 300           | 4 A  |  |
|   | max. making/breaking apparent power at B 300       | 3600/360 VA  |  |
| Mechanical lifetime   |  | 30 x 10 <sup>6</sup> switching cycles                      |  |
| Electrical lifetime (AC12, 230 V, 4 A)                        |  | 0.1 x 10 <sup>6</sup> switching cycles                     |  |
| Max. fuse rating to achieve short-circuit protection          | n/c contact  | 6 A fast-acting  |  |
|   | n/o contact  | 10 A fast-acting   |  |
| Conventional thermal current I <sub>th</sub> (IEC/EN 60947-1) |  | 4 A  |  |
| <b>General data</b>   |  |  |  |
| Duty time   |  | 100 %  |  |
| Dimensions (W x H x D)  |  | 22.5 x 78 x 100 mm<br>[0.89 x 3.07 x 3.94 in]              | 45 x 78 x 100 mm<br>[1.78 x 3.07 x 3.94 in]                  |
| Weight  | gross weight                                       | 0.149 kg [0.328 lb]  | 0.163 kg [0.359 lb]  |
|   | net weight   | 0.127 kg [0.280 lb]  | 0.133 kg [0.293 lb]  |
| Mounting  |  | DIN rail (EN 60715), snap-on mounting without any tool     |  |
| Mounting position   |  | any  |  |
| Minimum distance to other units                               | vertical   | not necessary  |  |
|   | horizontal   | 10 mm [0.4 in]<br>at U <sub>n</sub> > 240 V                | 10 mm [0.4 in]<br>at U <sub>n</sub> > 400 V                  |
| Degree of protection  | housing / terminal                                 | IP50 / IP20  |  |
| <b>Electrical connection</b>                                  |  |  |  |
| Wire size   | fine-strand with(out) wire end ferrule             | 2 x 0.75-2.5 mm <sup>2</sup> (2 x 18-14 AWG)               |  |
|   | rigid  | 2 x 0.5-4 mm <sup>2</sup> (2 x 20-12 AWG)                  |  |
| Stripping length  |  | 7 mm [0.28 in]   |  |
| Tightening torque   |  | 0.6-0.8 Nm [5.31-7.08 lb.in]                               |  |
| <b>Environmental data</b>                                     |  |  |  |
| Ambient temperature ranges                                    | operation/storage/ transport                       | -25...+60 °C/-40...+85 °C/-40...+85 °C                     |  |
| Climatic category   | IEC/EN 60721-3-3                                   | 3K5 (no condensation, no ice formation)                    |  |
| Damp heat, cyclic   | IEC/EN 60068-2-30                                  | 6 x 24 h cycle, 55 °C, 95 % RH                             |  |
| Vibration, sinusoidal   | IEC/EN 60255-21-1                                  | Class 2  |  |
| Shock, half-sine  | IEC/EN 60255-21-2                                  | Class 2  |  |

6

# Insulation monitoring relays for unearthed supply systems

## Technical data

6

|  |                             | CM-IWS.2  | CM-IWS.1               | CM-IWN.1,4,5,6         |
|--|-----------------------------|---|------------------------|------------------------|
| <b>Isolation data</b>  |                             |   |                        |                        |
| Rated impulse withstand voltage $U_{imp}$<br>between all isolated circuits<br>(IEC/EN 60947-1, IEC/EN 60664-1, VDE 0110-1) | supply / measuring circuit  |   | 6 kV                   |                        |
|  | supply / output circuit     |   | 6 kV                   |                        |
|  | measuring / output circuit  |   | 6 kV                   |                        |
|  | output 1 / output circuit 2 |   |                        | 4 kV                   |
| Pollution degree (IEC/EN 60664-1, VDE 0110-1)  |                             |   | 3                      |                        |
| Overvoltage category (IEC/EN 60664-1, VDE 0110-1)  |                             |   | III                    |                        |
| Rated insulation voltage $U$<br>(IEC/EN 60947-1, IEC/EN 60664-1, VDE 0110-1)   | supply / measuring circuit  | 400 V   | 300 V                  | 600 V                  |
|  | supply / output circuit     |   | 300 V                  |                        |
|  | supply / measuring circuit  | 400 V   | 300 V                  | 600 V                  |
|  | output 1 / output circuit 2 | -   | -                      | 300 V                  |
| Basis isolation for rated control supply voltage<br>(IEC/EN 60664-1, VDE 0110-1)   | supply / measuring circuit  | 400 V AC /<br>300 V DC  | 250 V AC /<br>300 V DC | 400 V AC /<br>600 V DC |
|  | supply / output circuit     |   | 250 V AC / 300 V DC    |                        |
|  | measuring / output circuit  | 400 V AC /<br>300 V DC  | 250 V AC /<br>300 V DC | 400 V AC /<br>600 V DC |
|  | output 1 / output 2         |   | 250 V AC / 300 V DC    |                        |
| Protective separation (IEC/EN 61140)   | supply / output circuit     |   | 250 V AC / 250 V DC    |                        |
|  | supply / measuring circuit  |   | 250 V AC / 250 V DC    |                        |
|  | measuring / output circuit  |   | 250 V AC / 250 V DC    |                        |
|  | supply / output circuit     |   | 2.32 kV, 50 Hz, 2 s    |                        |
| Test voltage between all isolated circuits, routine test<br>(IEC/EN 60255-5, IEC/EN 61010-1)                               | supply / measuring circuit  |   | 2.32 kV, 50 Hz, 2 s    |                        |
|  | supply / measuring circuit  |   | 2.32 kV, 50 Hz, 2 s    |                        |
|  | measuring / output circuit  | 2.2 kV, 50 Hz, 1 s  |                        | 2.53 kV, 50 Hz, 1 s    |
|  |                             |   |                        |                        |
| <b>Standards</b>   |                             |   |                        |                        |
| Product standard   |                             | IEC/EN 61557-8, IEC/EN 60255-6  |                        |                        |
| Other standards  |                             | EN 50178  |                        |                        |
| Low Voltage Directive  |                             | 2006/95/EC  |                        |                        |
| EMC Directive  |                             | 2004/108/EC   |                        |                        |
| RoHS Directive   |                             | 2002/95/EC  |                        |                        |
| <b>Electromagnetic compatibility</b>   |                             |   |                        |                        |
| Interference immunity to   |                             | IEC/EN 61000-6-1, IEC/EN 61000-6-2, IEC/EN 61326-2-4  |                        |                        |
| electrostatic discharge  | IEC/EN 61000-4-2            | Level 3, 6 kV / 8 kV  |                        |                        |
| radiated, radio-frequency, electromagnetic field   | IEC/EN 61000-4-3            | Level 3, 10 V/m (1 GHz) / 3 V/m (2 GHz) / 1 V/m (2.7 GHz)                                     |                        |                        |
| electrical fast transient/burst  | IEC/EN 61000-4-4            | Level 3, 2 kV / 5 kHz   |                        |                        |
| surge  | IEC/EN 61000-4-5            | Level 3, installation class 3, supply circuit and measuring circuit<br>1 kV L-L, 2 kV L-earth |                        |                        |
| conducted disturbances,<br>induced by radio-frequency fields   | IEC/EN 61000-4-6            | Level 3, 10 V   |                        |                        |
| voltage dips, short interruptions<br>and voltage variations  | IEC/EN 61000-4-11           | Level 3   |                        |                        |
| harmonics and interharmonics   | IEC/EN 61000-4-13           | Level 3   |                        |                        |
| high-frequency radiated  | IEC/CISPR 22, EN 50022      | IEC/EN 61000-6-3, IEC/EN 61000-6-4<br>Class B   |                        |                        |
| high-frequency conducted   | IEC/CISPR 22, EN 50022      | Class B   |                        |                        |



# Insulation monitoring relays for unearthed supply systems

## Technical data

Measuring &  
monitoring relays  
CM Range

6

### Technical data - CM-IVN

| Input circuit - Measuring circuit  |  | VL+, VL-, V±   |
|--|--|--|
| Function   |  | expansion of the nominal voltage range of the insulation monitoring relay CM-IWN.1 to 690 V AC or 1000 V DC, max. length of connection cable 40 cm |
| Measuring principle  |  | see CM-IWN.1   |
| Nominal voltage $U_n$ of the distribution system to be monitored   |  | 0-690 V AC / 0-1000 V DC   |
| Voltage range of the distribution system to be monitored   |  | 0-793.5 V AC / 0-1150 V DC (tolerance +15 %)   |
| Rated frequency $f_N$ of the distribution system to be monitored   |  | DC or 15-400 Hz  |
| Tolerance of the rated frequency $f_N$   |  | 13.5-440 Hz  |
| System leakage capacitance $C_e$   | max.                                   | 20 $\mu$ F   |
| Extraneous DC voltage $U_d$ (when connected to an AC system)   | max.                                   | 793.5 V DC   |
| Tolerance of the adjusted threshold value / Relative percentage uncertainty A at -5...+45 °C, $U_n = 0-115$ %        | at 1-15 k $\Omega$ $R_F$               | $\pm 1.5$ k $\Omega$   |
| $U_n = 85-110$ %   | at 15-200 k $\Omega$ $R_F$             | $\pm 8$ %  |
| $f_N, f_c, C_e = 1 \mu$ F  |  |  |
| Internal impedance Z   | at 50 Hz                               | 195 k $\Omega$   |
| Internal DC resistance $R_i$   |  | 200 k $\Omega$   |
| Measuring voltage $U_m$  |  | 24 V   |
| Tolerance of measuring voltage $U_m$   |  | +10 %  |
| Measuring current $I_m$  |  | 0.15 mA  |
| <b>General data</b>  |  |  |
| MTBF   |  | on request   |
| Duty time  |  | 100 %  |
| Dimensions (W x H x D)   |  | 45 x 78 x 100 mm [1.78 x 3.07 x 3.94 in]   |
| Weight   | gross weight                           | 0.200 kg [0.441 lb]  |
|  | net weight                             | 0.169 kg [0.373 lb]  |
| Mounting   |  | DIN rail (IEC/EN 60715), snap-on mounting without any tool   |
| Mounting position  |  | any  |
| Minimum distance to other units  | vertical                               | not necessary  |
|  | horizontal                             | 10 mm [0.4 in] at $U_n > 600$ V  |
| Degree of protection   |  | IP50 / IP20  |
| <b>Electrical connection</b>   |  |  |
| Wire size  | fine-strand with(out) wire end ferrule | 2 x 0.75-2.5 mm <sup>2</sup> (2 x 18-14 AWG)   |
|  | rigid                                  | 2 x 0.5-4 mm <sup>2</sup> (2 x 20-12 AWG)  |
| Stripping length   |  | 7 mm [0.28 in]   |
| Tightening torque  |  | 0.6-0.8 Nm [5.31-7.08 lb.in]   |
| Max. length of connection cable to CM-IWN.1  |  | 40 cm  |
| <b>Environmental data</b>  |  |  |
| Ambient temperature ranges   | operation / storage / transport        | -25...+60 °C / -40...+85 °C / -40...+85 °C   |
| Climatic category  | IEC/EN 60721-3-3                       | 3K5 (no condensation, no ice formation)  |
| Damp heat, cyclic  | IEC/EN 60068-2-30                      | 6 x 24 h cycle, 55 °C, 95 % RH   |
| Vibration, sinusoidal  | IEC/EN 60255-21-1                      | Class 2  |
| Shock, half-sine   | IEC/EN 60255-21-2                      | Class 2  |
| <b>Isolation data</b>  |  |  |
| Rated impulse withstand voltage $U_{imp}$ between all isolated circuits (IEC/EN 60947-1, IEC/EN 60664-1, VDE 0110-1) | input circuit / PE                     | 8 kV   |
| Pollution degree (IEC/EN 60664-1, VDE 0110-1)  |  | 3  |
| Overvoltage category (IEC/EN 60664-1, VDE 0110-1)  |  | III  |
| Rated insulation voltage $U_i$ (IEC/EN 60947-1, IEC/EN 60664-1, VDE 0110-1)  | input circuit / PE                     | 1000 V   |
| Test voltage between all isolated circuits, routine test (IEC/EN 60255-5, IEC/EN 61010-1)                            | input circuit / PE                     | 3.3 kV, 50 Hz, 1 s   |
| <b>Standards</b>   |  |  |
| Product standard   |  | IEC/EN 61557-8, IEC/EN 60255-6   |
| Other standards  |  | EN 50178   |
| Low Voltage Directive  |  | 2006/95/EC   |
| EMC Directive  |  | 2004/108/EC  |
| RoHS Directive   |  | 2002/95/EC   |
| <b>Electromagnetic compability</b>   |  |  |
| Interference immunity to   |  | IEC/EN 61000-6-1, IEC/EN 61000-6-2, IEC/EN 61326-2-4   |
| electrostatic discharge  | IEC/EN 61000-4-2                       | Level 3, 6 kV / 8 kV   |
| radiated, radio-frequency, electromagnetic field   | IEC/EN 61000-4-3                       | Level 3, 10 V/m (1 GHz) / 3 V/m (2 GHz) / 1 V/m (2.7 GHz)  |
| electrical fast transient/burst  | IEC/EN 61000-4-4                       | Level 3, 2 kV / 5 kHz  |
| surge  | IEC/EN 61000-4-5                       | Level 3, installation class 3, supply circuit and measuring circuit 1 kV L-L, 2 kV L-earth   |
| conducted disturbances, induced by radio-frequency fields  | IEC/EN 61000-4-6                       | Level 3, 10 V  |
| voltage dips, short interruptions and voltage variations   | IEC/EN 61000-4-11                      | Level 3  |
| harmonics and interharmonics   | IEC/EN 61000-4-13                      | Level 3  |
| Interference emission  |  | IEC/EN 61000-6-3, IEC/EN 61000-6-4   |
| high-frequency radiated  | IEC/CISPR 22, EN 50022                 | Class B  |
| high-frequency conducted   | IEC/CISPR 22, EN 50022                 | Class B  |

# Insulation monitoring relays for unearthed supply systems

## Application examples

### Application example CM-IWS.2

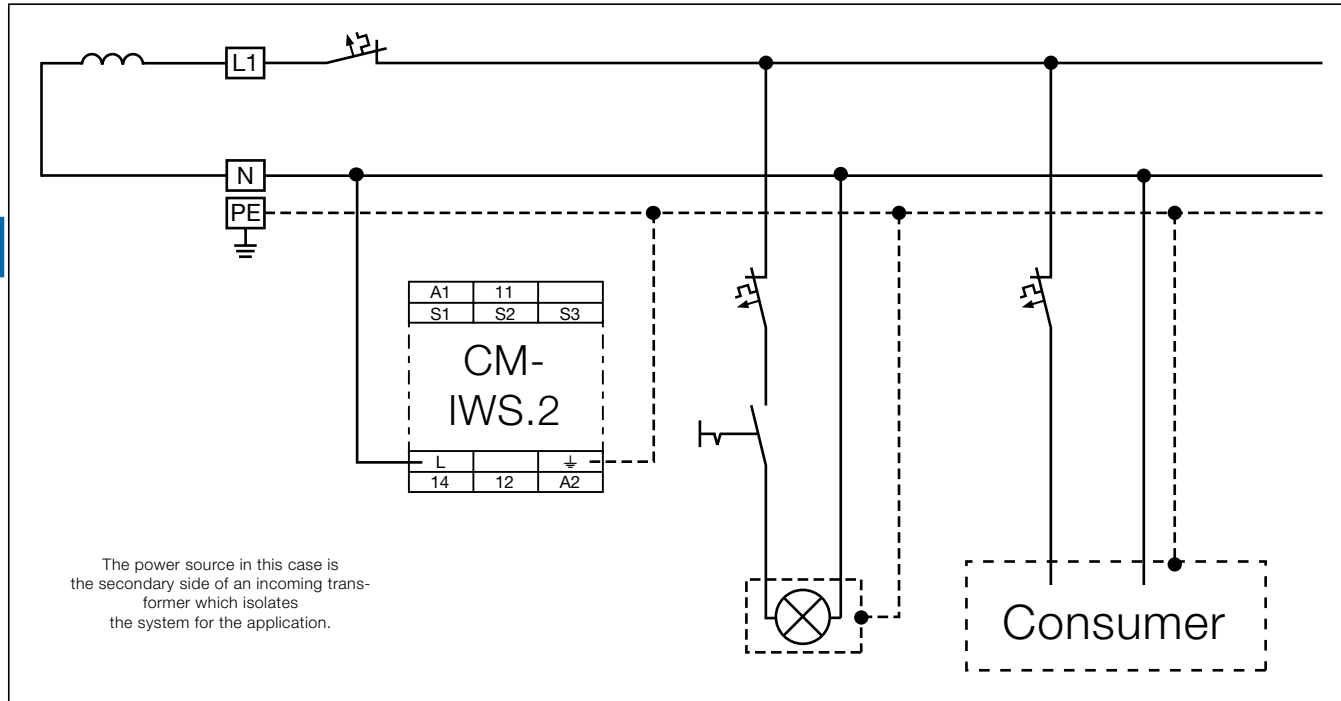

### Application example CM-IWS.1

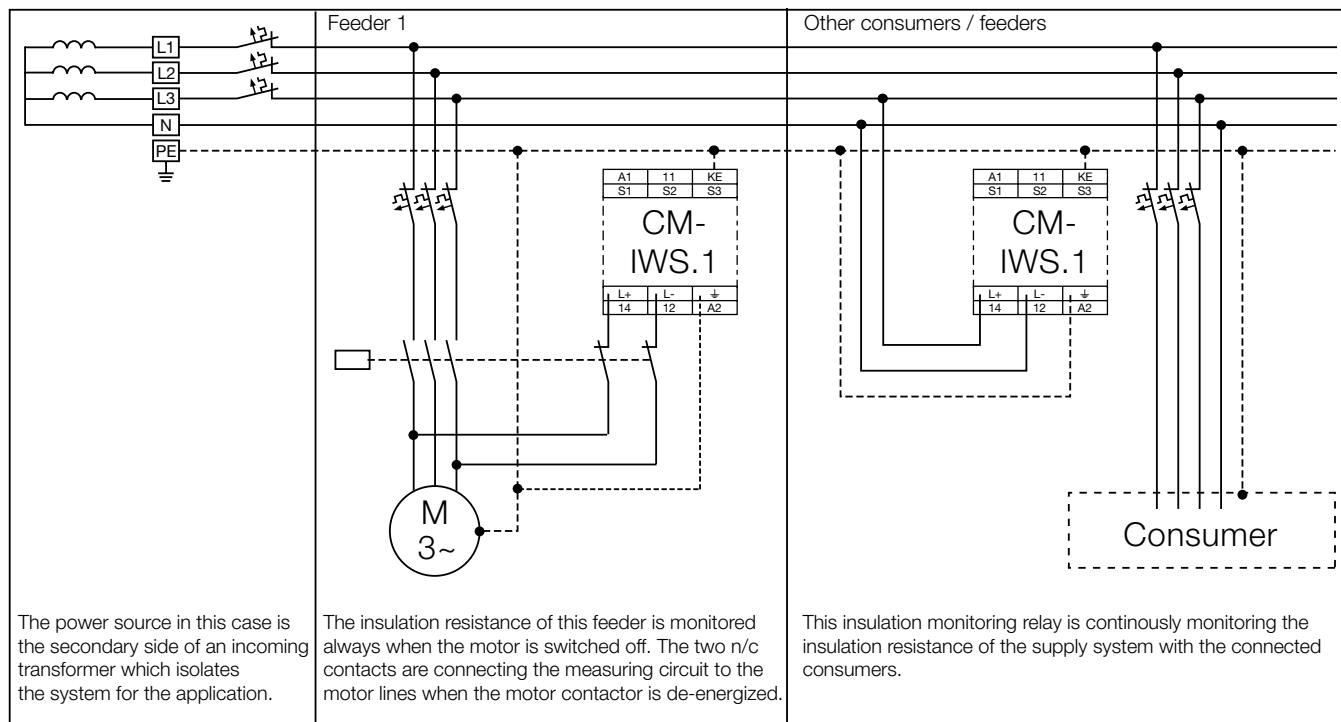

Earth fault / insulation resistance monitoring of different feeder circuits with fault localization.

# CM-E Range Motor load monitoring relays



Motor load monitoring relays



# Motor load monitoring relays

## Fields of application

The motor load monitor relay monitors the load states of single-phase and three-phase asynchronous motors. The evaluation of the phase angle between current and voltage allows a very precise monitoring of the load states.

Compared with other conventional measuring principles (e.g. pressure transducers, current measurement),  $\cos \varphi$  monitoring is a more precise and economical alternative. The motor is used as a sensor for its own load status.

### Main applications

- Pump monitoring
  - Dry-running protection (underload)
  - Closed valves (overload)
  - Pipe break (overload)
- Heating, air-conditioning, ventilation
  - Monitoring of filter pollution
  - V-belt breakage (underload)
  - Closed shutters/valves (overload)
  - Air ventilating volume
- Agitating machines
  - High consistency within the tank (overload)
  - Pollution of the tank (overload)
- Transport/Conveyance
  - Congested conveyor belts (overload)
  - Jamming of belts (overload)
  - Material accumulation in spiral conveyors (overload)
  - Lifting platforms
- Machine installation
  - Wear of tools, e.g. worn saw blades in circular saws, etc. (overload)
  - Tool breakage (underload)
  - V-belt drives (breakage underload)

### Pump control

Dry-running protection

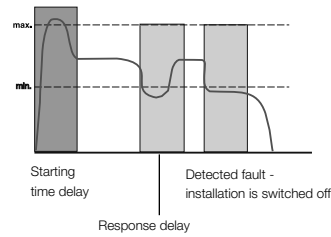

Filter pollution

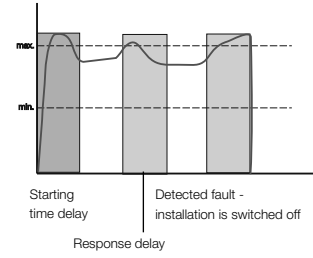

### Ventilator monitoring

V-belt monitoring

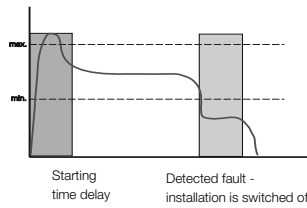

Filter pollution

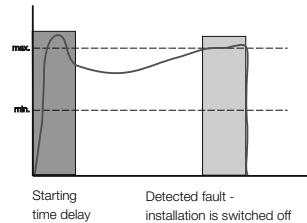

### Wiring examples (for motor currents $\leq 20$ A)

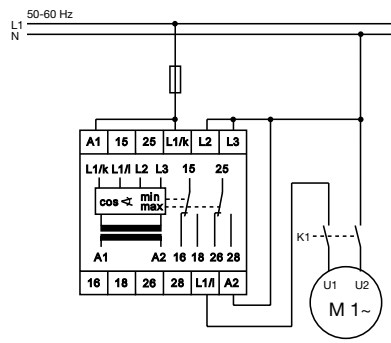
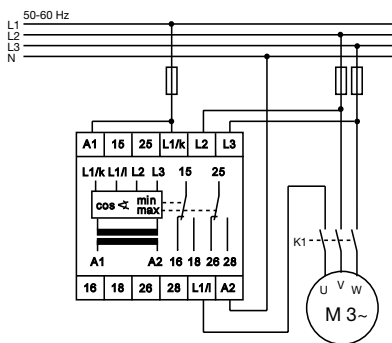

### Wiring examples (for motor currents $\geq 20$ A)

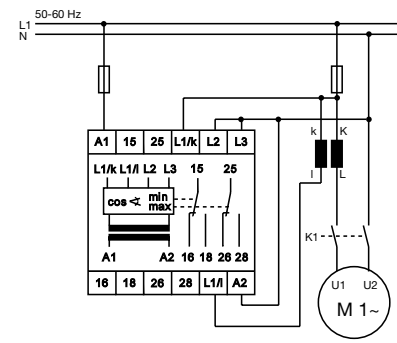
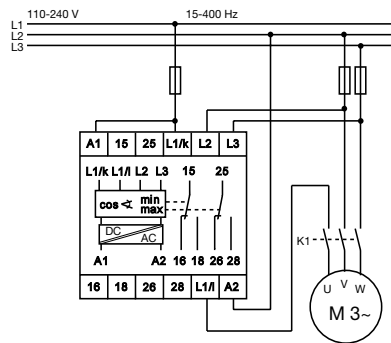
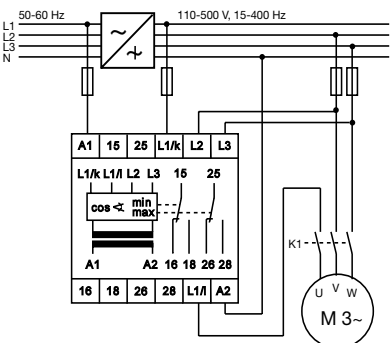
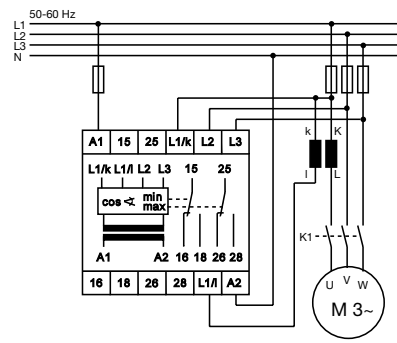

## Motor load monitoring relays

### Ordering details



CM-LWN

#### Description

The motor load monitor CM-LWN monitors the load of single-phase and three-phase asynchronous motors. The evaluation of the phase angle between current and voltage ( $\cos \varphi$  monitoring) allows a very precise monitoring of the load status.

#### Ordering details

| Rated control supply voltage = measuring voltage | Current range | Reference code | Catalog number  | Weight (1 pce)<br>kg (lb) |
|--|---------------|----------------|-----------------|---------------------------|
| 24-240 V AC/DC                                   | 0.5-5 A       | CM-LWN         | 1SVR450335R0000 | 0.30 (0.66)               |
| 110-130 V AC                                     |               |                | 1SVR450330R0000 | 0.30 (0.66)               |
| 220-240 V AC                                     |               |                | 1SVR450331R0000 | 0.30 (0.66)               |
| 380- 440 V AC                                    |               |                | 1SVR450332R0000 | 0.30 (0.66)               |
| 480-500 V AC                                     |               |                | 1SVR450334R0000 | 0.30 (0.66)               |
| 24-240 V AC/DC                                   | 2-20 A        |                | 1SVR450335R0100 | 0.30 (0.66)               |
| 110-130 V AC                                     |               |                | 1SVR450330R0100 | 0.30 (0.66)               |
| 220-240 V AC                                     |               |                | 1SVR450331R0100 | 0.30 (0.66)               |
| 380- 440 V AC                                    |               |                | 1SVR450332R0100 | 0.30 (0.66)               |
| 480-500 V AC                                     |               |                | 1SVR450334R0100 | 0.30 (0.66)               |

#### Characteristics

- Pump monitoring
- Under and overload monitoring  $\cos \varphi$  and  $\cos \varphi$  in one unit
- Adjustable starting delay 0.3-30 s
- Direct measurement of currents up to 20 A
- Adjustable response time delay 0.2-2 s
- Single-phase or three-phase monitoring
- 2 x 1 c/o contact, closed-circuit principle
- 3 LEDs for status indication
- Under- and overload monitoring

## Motor load monitoring relays

### Technical information

The **CM-LWN** module monitors the load status of inductive loads.

The primary application is the monitoring of single- or three-phase asynchronous motors (squirrel cage) under varying load conditions. The measuring principle is based on the evaluation of the phase shift ( $\varphi$ ) between the voltage and the current in one phase.

The phase difference is nearly inversely proportional to the load. Therefore,  $\cos \varphi$ , measured relatively from 0 to 1, measures the relationship of effective power to apparent power. A value towards 0 indicates low load and a value towards 1 indicates high load.

Threshold values can be set individually for  $\cos \varphi_{\max}$  and  $\cos \varphi_{\min}$ . If the set threshold value is reached, a LED lights up and the relay is de-energized.

If  $\cos \varphi$  returns to the acceptable limits (taking into account the hysteresis), the relay is reset to its original state and the LED flashes permanently to indicate the occurrence of the trip event. This message can be deleted using the reset button or by switching off the supply.

A time delay (Time S) of 0.3 to 30 s can be set for the starting phase of the motor. It is also possible to set a response delay time (Time R) of 0.2 to 2 s to suppress unwanted tripping due to unavoidable short load changes during normal operation.

**6** To guarantee correct operation of the response delay (Time R), the adjusted value for  $\cos \varphi_{\max}$  has to be higher than the value for  $\cos \varphi_{\min}$  plus the hysteresis. Consequently, the overload and underload indication must not be active at the same time.

Due to the internal electrical isolation of the supply circuit and the measuring circuit, it is also possible to use the device in systems with different supply voltages.

#### Function diagram CM-LWN

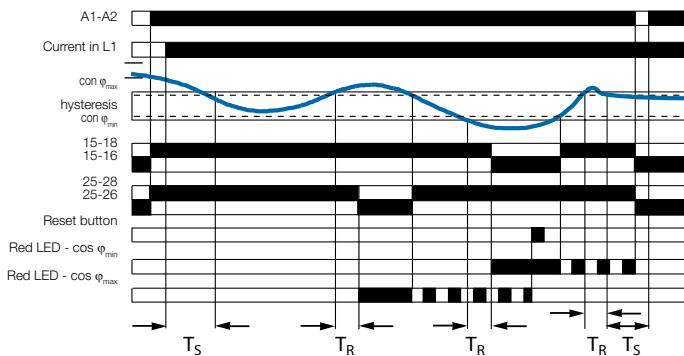

#### Connection diagram CM-LWN

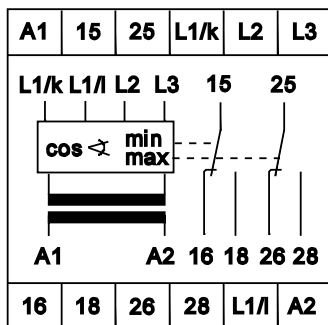

- A1-A2 Rated control supply voltage
- L1/K-L1/L Measuring current
- L1/K-L2-L3 Measuring voltage
- 15-16/18 Output contacts - underload ( $\cos \varphi_{\min}$ )
- 25-26/28 Output contacts - overload ( $\cos \varphi_{\max}$ ) closed-circuit principle

# Motor load monitoring relays

## Technical data

|   |  |  |
|---|--|--|
| <b>Type</b>   |  | CM-LWN   |
| <b>Input circuit - Supply circuit</b>                                   |  | A1-A2  |
| Rated control supply voltage $U_s$ - power consumption                  | A1-A2  | 24-240 V AC/DC approx. 8.4 VA/W  |
|   | A1-A2  | 110-130 V AC approx. 3.6 VA  |
|   | A1-A2  | 220-240 V AC approx. 3.6 VA  |
|   | A1-A2  | 380-440 V AC approx. 3.6 VA  |
|   | A1-A2  | 480-500 V AC approx. 3.6 VA  |
| Rated control supply voltage $U_s$ tolerance                            |  | -15 %...+10 %  |
| Rated frequency   | AC versions  | 50-60 Hz   |
|   | AC/DC versions                                     | 15-400 Hz or DC  |
| Duty time   |  | 100 %  |
| <b>Measuring circuit</b>  |  | L1/L-L1/K-L2-L3  |
| Monitoring function   |  | Motor load monitoring by $\cos \varphi$                                |
| Voltage range   | L1/K-L2-L3   | 110-500 V AC single-phase or three-phase                               |
| Current range   | L1/L-L1/K  | 0.5-5 A version 2-20 A version   |
| Permissible overload of current input                                   |  | 25 A for 3 s 100 A for 3 s   |
| Thresholds  |  | $\cos \varphi_{\min}$ and $\cos \varphi_{\max}$ adjustable from 0 to 1 |
| Hysteresis (related to phase angle $\varphi$ in °)                      |  | 4°   |
| Frequency of measuring voltage  |  | 15-400 Hz  |
| Response time   |  | 300 ms   |
| <b>Timing circuits</b>  |  | indication of over- and undervoltage fault                             |
| Start-up time (Time S)  |  | 0.3-30 s, adjustable   |
| Response delay (Time R)   |  | 0.2-2 s, adjustable  |
| Accuracy within the rated control supply voltage tolerance              |  | $\Delta t \leq 0.5 \%$   |
| Accuracy within the temperature range                                   |  | $\Delta t \leq 0.06 \%$ / °C   |
| <b>Indication of operational states</b>                                 |  |  |
| Control supply voltage  |  | U: green LED   |
| below $\cos \varphi_{\min}$   |  | $\cos \varphi_{\min}$ : red LED  |
| $\cos \varphi_{\max}$ exceeded  |  | $\cos \varphi_{\max}$ : red LED  |
| <b>Output circuits</b>  |  | 15-16/18, 25-26/28   |
| Kind of output  |  | 2 x 1 c/o contact  |
| Operational principle <sup>1)</sup>                                     |  | closed-circuit principle   |
| Contact material  |  | AgCdO  |
| Rated voltage (VDE 0110, IEC 664-1, IEC 947-1)                          |  | 250 V  |
| Max. switching voltage  |  | 400 V AC, 300 V DC   |
| Rated operational current $I_b$ (IEC/EN 60947-1)                        | AC12 (resistive) 230 V                             | 4 A  |
|   | AC15 (inductive) 230 V                             | 3 A  |
|   | DC12 (resistive) 24 V                              | 4 A  |
|   | DC13 (inductive) 24 V                              | 2 A  |
| AC rating (UL 508)  | Utilization category (Control Circuit Rating Code) | B 300  |
|   | max. rated operational voltage                     | 300 V AC   |
|   | max. continuous thermal current at B 300           | 5 A  |
|   | max. making/breaking apparent power at B 300       | 3600/360 VA  |
| Mechanical lifetime   |  | $30 \times 10^6$ switching cycles                                      |
| Electrical lifetime   | at AC12, 230 V, 4 A                                | $0.1 \times 10^6$ switching cycles                                     |
| Max. fuse rating to achieve short-circuit protection                    | n/c / n/o contact                                  | 10 A fast-acting / 10 A fast-acting                                    |
| <b>General data</b>   |  |  |
| Dimensions (W x H x D)  |  | 45 mm x 78 mm x 100 mm (1.77 inch x 3.07 inch x 3.94 inch)             |
| Mounting position   |  | any  |
| Degree of protection  | housing / terminals                                | IP50 / IP20  |
| Ambient temperature range   | operation / storage                                | -25...+65 °C / -40...+85 °C  |
| Mounting  |  | DIN rail (IEC/EN 60715)  |
| <b>Electrical connection</b>  |  |  |
| Wire size   | fine-strand with wire end ferrule                  | 2 x 2.5 mm <sup>2</sup> (2 x 14 AWG)                                   |
| <b>Standards</b>  |  |  |
| Product standard  |  | IEC 255-6, EN 60255-6  |
| Low Voltage Directive   |  | 2006/95/EC   |
| EMC Directive   |  | 2004/108/EC, 91/263/EEC, 92/31/EEC, 93/68/EEC, 93/67/EEC               |
| <b>Electromagnetic compatibility</b>                                    |  | EN 61000-6-2, EN 61000-6-4   |
| electrostatic discharge   | IEC/EN 61000-4-2                                   | Level 3 (6 kV / 8 kV)  |
| radiated, radio-frequency, electromagnetic field                        | IEC/EN 61000-4-3                                   | Level 3 (10 V/m)   |
| electrical fast transient / burst                                       | IEC/EN 61000-4-4                                   | Level 3 (2 kV / 5 kHz)   |
| surge   | IEC/EN 61000-4-5                                   | Level 4 (2 kV L-L)   |
| conducted disturbances, induced by radio-frequency fields               | IEC/EN 61000-4-6                                   | Level 3 (10 V)   |
| Operational reliability (IEC 68-2-6)                                    |  | 5 g  |
| Mechanical resistance (IEC 68-2-6)                                      |  | 10 g   |
| Environmental testing (IEC 68-2-30)                                     |  | 24 h cycle time, 55 °C, 93 % rel., 96 h                                |
| <b>Isolation data</b>   |  |  |
| Rating (HD 625.1 S1, VDE 0110, IEC 664-1, IEC 60255-5)                  |  | 250 V, 400 V, 500 V depending on the version                           |
| Rated insulation voltage between supply-, measuring- and output circuit |  | 4 kV / 1.2 - 50 us   |
| Rated impulse withstand voltage between all isolated circuits           |  | 2.5 kV, 50 Hz, 1 min.  |
| Test voltage between all isolated circuits                              |  | 3  |
| Pollution category  |  | III  |
| Overvoltage category  |  | III  |

<sup>1)</sup> Open-circuit principle: Output relay is energized if the measured value exceeds/drops below the adjusted threshold.

Closed-circuit principle: Output relay is de-energized if the measured value exceeds/drops below the adjusted threshold.

## Notes





# CM-E Range Motor control and protection

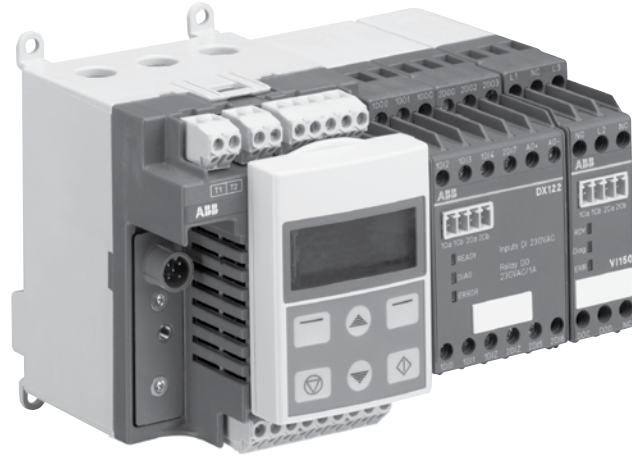

## Motor control and protection

### Benefits and advantages

UMC100-FBP is a flexible, modular and expandable motor management system for constant-speed low-voltage range motors.

Its most important tasks include motor protection, prevention of plant standstills and the reduction of down time. This is made possible by early information relating to possible motor problems which avoids unplanned plant standstills. Even if a motor trips, quick diagnosis of the cause of the fault serves to reduce downtime.

UMC100-FBP combines in a very compact unit:

#### Motor protection

- Overload, underload
- Overvoltage, undervoltage
- Blocked rotor, low / high current
- Phase failure, imbalance, phase sequence
- Earth leakage
- Thermistor protection
- Limitation of starts per time
- One single version with integrated measuring system covers the rated motor current from 0,24 to 63 A

#### Motor control

- Integrated and easy to parametrize motor starter functions like direct, reverse, star-delta,...
- Additionally free programmable logic for application specific control functions
- Expansion modules DX111, DX122 for more I/Os
- Expansion modules VI150, VI155 for 3-phase voltage measuring

#### Motor diagnostics

- Quick and comprehensive access to all relevant data via fieldbus and/or operator panel
- Current, thermal load
- Phase voltages
- Power factor
- Energy

#### Communication

- Communication-independent basic device
- Freely selectable fieldbus protocol with FieldBusPlug
- Profibus DP
- DeviceNet
- Modbus
- CANopen

#### Typical application segments

- Oil & gas
- Cement
- Paper
- Mining
- Steel
- Chemical industry

#### Further information

UMC & FBP Catalogue 2CDC 190 022 D0204  
UMC & FBP Brochure 2CDC 135 011 B0202

# Motor control and protection

## Technical data



### Basic device UMC100-FBP

UMC100-FBP allows the connection of one I/O-expansion module DX111 or DX122, and one voltage module VI150 or VI155. Expansion modules are connected via 2-wire bus, the max. distance to UMC100-FBP is 3 m.

#### Main power

|                          |   |
|--------------------------|---|
| Voltage                  | max 1000 V AC   |
| Frequency                | 45 to 65 Hz   |
| Rated motor current      | 0.24 to 63 A, without accessories                     |
|                          | Greater currents with transformer                     |
| Transformer diameter     | 11 mm (max 25 mm <sup>2</sup> )                       |
| Tripping classes         | 5, 10, 20, 30, 40 in accordance with EN/IEC 60947-4-1 |
| Short-circuit protection | Separate fuse on network side                         |

6

#### Control unit

|                             |   |
|-----------------------------|---|
| Supply voltage              | 24 V DC   |
| Reverse polarity protection | yes   |
| Inputs                      | 6 digital inputs 24 V DC                        |
|                             | 1 PTC input                                     |
| Outputs                     | 3 relay outputs relay                           |
|                             | 1 digital output transistor                     |
| Interfaces                  | 1 for ABB FieldBusPlug                          |
|                             | 1 for UMC100-PAN control station                |
|                             | 1 for expansion module                          |
| Parametric assignment       | via fieldbus, control station and / or software |
| Addressing                  | Control station or addressing set               |
| LEDs                        | 3 LEDs: green, yellow, red                      |

#### Environment and mechanical data

|                        |  |
|------------------------|--|
| Fastening              | on DIN busbar (EN50022-35) or with 4 screws x M4         |
| Dimensions (W x H x D) | 70 x 105 x 110 mm (incl. FieldBusPlug and control panel) |
| Weight                 | 0.39 kg  |
| Terminal cross-section | max. 2.5 mm <sup>2</sup> or 2 x 1.5 mm <sup>2</sup>      |



### I/O-expansion modules DX111 / DX122

Expansion modules to increase the number of I/Os of a UMC100-FBP. Easy use of inputs by parametrizing for fault or warning; individual message on operator panel configurable.

|                        |   |  |
|------------------------|---|--|
| Supply voltage         | 24 V DC                                   |  |
| Inputs                 | DX111                                     | 8 digital inputs 24 V DC                                 |
|                        | DX122                                     | 8 digital inputs 110/230 V AC                            |
| Outputs                |   | 4 relay outputs relay                                    |
|                        |   | 1 analogue output, 0/4 to 20 mA / 0 to 10 V configurable |
| Fastening              | on DIN busbar (EN50022-35)                |  |
| Dimensions (W x H x D) | 45 x 77 x 100 mm (without terminal block) |  |

## Motor control and protection

### Technical data

#### Voltage expansion modules

Measures the 3 phase voltages of a motor. Different versions for use in grounded and ungrounded networks.



|                        |       |   |
|------------------------|-------|---|
| Supply voltage         |       | 24 V DC                                     |
| Inputs                 | VI150 | 3 analogue inputs 150 - 690 V AC            |
|                        |       | For use in grounded networks                |
|                        |       | Maximum operation altitude 2000 m           |
| Inputs                 | VI155 | 3 analogue inputs 150 - 690 V AC            |
|                        |       | For use in all networks                     |
|                        |       | Maximum operation altitude > 2000 m         |
| Outputs                |       | 1 relay output                              |
| Fastening              |       | on DIN busbar (EN50022-35)                  |
| Dimensions (W x H x D) |       | 22.5 x 77 x 100 mm (without terminal block) |

#### Control panel UMC100-PAN

Installation on the device or on the switching cabinet door

Graphics-enabled and backlit display, 3 LEDs for status indication

Freely configurable error messages

Multilingual: German, English, French, Italian, Portuguese, Spanish, Russian



For more detailed information about the UMC100, see section 2, pages 2.16 and 2.17

#### Universal motor controller – 0.24...63 A



UMC100-FBP

| Type           | Description  | Catalog number  |
|----------------|--|-----------------|
| UMC100-FBP.0   | Universal Motor Controller   | 1SAJ520000R0101 |
| UMC100-FBP.2   | Universal Motor Controller, ATEX   | 1SAJ520000R0201 |
| UMC100-PAN     | Operating, diagnostics and parameter setting panel; direct UMC mounting                                | 1SAJ590000R0102 |
| UMCPAN-CAB.070 | 0.7 m ext. cable with door mounting set  | 1SAJ510003R0001 |
| UMCPAN-CAB.150 | 1.5 m ext. cable with door mounting set  | 1SAJ510004R0001 |
| UMCPAN-CAB.30  | 3 m ext. cable with door mounting set  | 1SAJ510002R0001 |
| DTM software   | Advanced programming, parameter assignment   | 1SAJ924012R0004 |
| VI150-FBP.0    | Voltage Expansion Module, analog inputs 150...690V AC, 1 relay output, for 3-phase networks (grounded) | 1SAJ650000R0100 |
| VI155-FBP.0    | Voltage Expansion Module, analog inputs 150...690V AC, 1 relay output, for 3-phase networks (all)      | 1SAJ655000R0100 |



# CM-E Range Thermistor motor protection



# Thermistor motor protection relays

## Benefits and advantages

### Selection table

#### Operating principle and fields of application for thermistor motor protection relays

The CM range of thermistor motor protection relays are used to control motors equipped with PTC temperature sensors. The PTC temperature sensors are incorporated in the motor windings to measure the motor heating. This enables direct control and evaluation of the following operating conditions:

- heavy duty starting
- increased switching frequency
- single-phase operation
- high ambient temperature
- insufficient cooling
- break operation
- unbalance

6

The relay is independent of the rated motor current, the insulation class and the method of starting.

The PTC sensors are connected in series to the terminals  $T_a$  and  $T_b$  (or  $T_a$  and  $T_{bx}$  without short-circuit detection). The number of possible PTC sensors per measuring circuit is limited by the sum of the individual PTC sensor resistances:  $R_G = R_1 + R_2 + R_N \leq 1.5 \text{ k}\Omega$ .

Under normal operating conditions the resistance is below the response threshold. If only one of the PTC resistors heats up excessively, the output relay de-energizes. If the autoreset function is configured, the output relay energizes automatically after cooling down.

Devices with manual (pushbutton on front-side) or remote reset configuration have to be controlled via the control input by the required signal.

#### Further applications:

Temperature monitoring of equipment with PTC sensors integrated, such as

- machine rolling bearings,
- hot-air ventilators,
- oil,
- air,
- heating installations, etc.

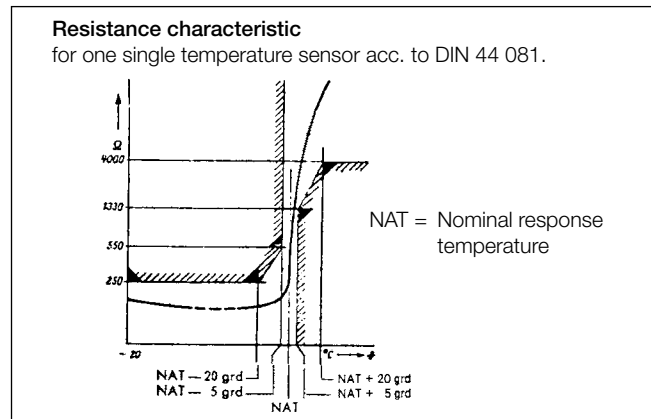

#### Selection table thermistor motor protection relays

| Type                                       | CM-MSE                   | CM-MSS (1)      | CM-MSS (2)      | CM-MSS (3)      | CM-MSS (4)      | CM-MSS (5)      | CM-MSS (6)               | CM-MSS (7)                            | CM-MSN                                |
|--|--------------------------|-----------------|-----------------|-----------------|-----------------|-----------------|--------------------------|---------------------------------------|---------------------------------------|
| <b>Function</b>                            |                          |                 |                 |                 |                 |                 |                          |                                       |                                       |
| <b>Measuring range</b>                     |                          |                 |                 |                 |                 |                 |                          |                                       |                                       |
| Number of sensor circuits                  | 1                        | 1               | 1               | 1               | 1               | 1               | 2                        | 3                                     | 6                                     |
| Wire break monitoring                      | •                        | •               | •               | •               | •               | •               | •                        | •                                     | •                                     |
| Short-circuit detection                    | -                        | -               | -               | • 1)            | •               | •               | •                        | •                                     | •                                     |
| Non-volatile fault storage                 | -                        | -               | -               | -               | • 2)            | • 2)            | -                        | • 2)                                  | • 2)                                  |
| <b>Operation/Reset</b>                     |                          |                 |                 |                 |                 |                 |                          |                                       |                                       |
| Auto reset                                 | •                        | •               | •               | •               | • 2)            | • 2)            | • 2)                     | • 2)                                  | • 2)                                  |
| Manual reset                               | -                        | -               | •               | •               | •               | •               | •                        | •                                     | •                                     |
| Remote reset                               | -                        | -               | •               | •               | •               | •               | •                        | •                                     | •                                     |
| Test button                                | -                        | -               | -               | -               | •               | •               | •                        | •                                     | •                                     |
| <b>Output contacts</b>                     |                          |                 |                 |                 |                 |                 |                          |                                       |                                       |
| Operational principle                      | closed-circuit principle |                 |                 |                 |                 |                 |                          |                                       |                                       |
| Number / type                              | 1 c/o                    | 1 c/o           | 2 c/o           | 2 c/o           | 1 n/o + 1 n/c   | 2 c/o           | 1 c/o per sensor circuit | 1 n/o + 1 n/c accumulative evaluation | 1 n/o + 1 n/c accumulative evaluation |
| Width of housing                           | 22.5 mm                  |                 |                 |                 |                 |                 |                          |                                       | 45 mm                                 |
| <b>Supply voltages and Reference codes</b> |                          |                 |                 |                 |                 |                 |                          |                                       |                                       |
| 24 V AC                                    | 1SVR550805R9300          |                 | 1SVR430811R9300 |                 |                 |                 |                          |                                       |                                       |
| 24 V AC/DC                                 |                          | 1SVR430800R9100 | 1SVR430810R9300 | 1SVR430710R9300 |                 |                 |                          |                                       |                                       |
| 110-130 V AC                               | 1SVR550800R9300          |                 | 1SVR430811R0300 | 1SVR430711R0300 |                 |                 |                          |                                       |                                       |
| 220-240 V AC                               | 1SVR550801R9300          | 1SVR430801R1100 | 1SVR430811R1300 | 1SVR430711R1300 |                 |                 |                          |                                       |                                       |
| 380-440 V AC                               |                          |                 |                 | 1SVR430711R2300 |                 |                 |                          |                                       |                                       |
| 24-240 V AC/DC                             |                          |                 |                 |                 | 1SVR430720R0400 | 1SVR430720R0300 | 1SVR430710R0200          | 1SVR430720R0500                       | 1SVR450025R0100                       |

1) configurable via terminals

2) Auto reset without non-volatile fault storage configurable by permanent jumpering of connecting terminals S1-T2 or S1/X1-S2/X2

# Thermistor motor protection relays

## Product overview

### CM-MSE

- Auto reset
- Connection of several sensors (max. 6 sensors conn. in series)
- Monitoring of bimetals
- 1 n/o contact
- Excellent cost / performance ratio

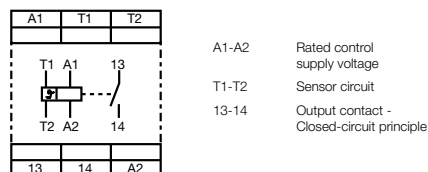

### CM-MSS (1), 1 c/o contact

- Auto reset
- Connection of several sensors
- Monitoring of bimetals
- 1 c/o contact
- 2 LEDs for status indication

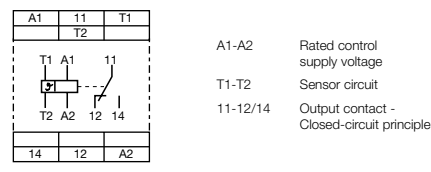

### CM-MSS (2), 2 c/o contacts

- Fault storage can be switched off
- Auto reset configurable
- Reset button
- Remote reset
- Monitoring of bimetals
- 2 c/o contacts
- 2 LEDs for status indication

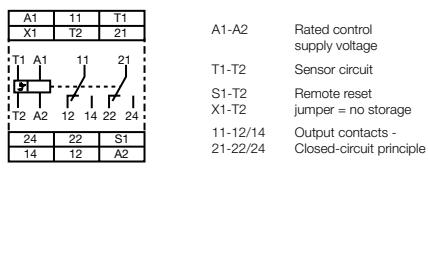

### CM-MSS (3), 2 c/o contacts, short-circuit monitoring configurable

- Fault storage can be switched off
- Auto reset configurable
- Reset button
- Remote reset
- Monitoring of bimetals
- Short-circuit monitoring of the sensor circuit configurable
- 2 c/o contacts
- 2 LEDs for status indication

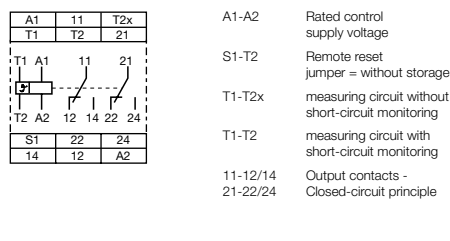

### CM-MSS (4) + CM-MSS (5), 1-channel

- Short-circuit monitoring of the sensor circuit
- Wide supply voltage range: 24-240 V AC/DC
- Non-volatile fault storage selectable
- Reset and test button
- Remote reset
- Auto reset configurable
- Output contacts: 1 n/c and 1 n/o or 2 c/o contacts
- 2 LEDs for status indication

### CM-MSS (4)

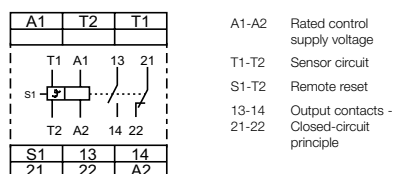

### CM-MSS (5)

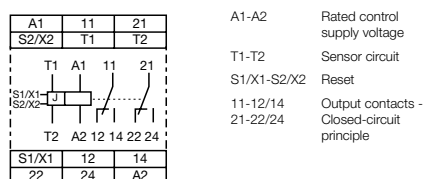

# Thermistor motor protection relays

## Product overview

6

### CM-MSS (6), 2-channel, single evaluation

- Short-circuit monitoring for the sensor circuits
- Wide supply voltage range: 24-240 V AC/DC
- 2 separate sensor circuits for monitoring of two motors or one motor with 2 sensor circuits (prewarning and final switch off)
- Reset button
- Auto reset configurable
- Output contacts: 2 x 1 c/o contact
- 3 LEDs for status indication

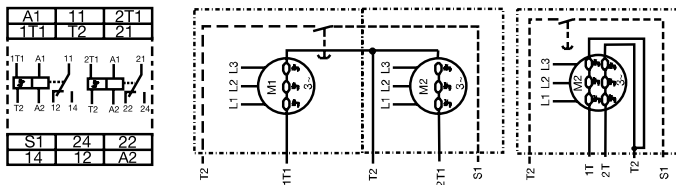

A1-A2 Rated control supply voltage  
11-12/14, 21-22/24 Output contacts - Closed-circuit principle  
1T1-T2 Sensor circuit  
2T1-T2

S1-T2 jumpered = no storage

### CM-MSS (7), 3 sensor circuits, accumulative evaluation

- Short-circuit monitoring for the sensor circuits
- Wide supply voltage range: 24-240 V AC/DC
- Non-volatile fault storage configurable
- Remote reset
- Auto reset configurable
- Reset and test button
- Output contacts: 1 n/c and 1 n/o contact
- 4 LEDs for status indication

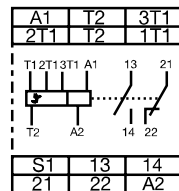

A1-A2 Rated control supply voltage  
13-14 Output contacts - Closed-circuit principle  
21-22

1T1-T2 Sensor circuits  
2T1-T2  
3T1-T2

S1-T2 Remote reset jumpered = no storage

### CM-MSN, 6 sensor circuits, accumulative evaluation

- Short-circuit monitoring of the sensor circuit
- Wide supply voltage range: 24-240 V AC/DC
- Non-volatile fault storage configurable
- Remote reset
- Auto reset configurable
- Reset and test button
- Output contacts: 1 n/c, 1 n/o contact
- 7 LEDs for status indication

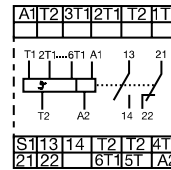

A1-A2 Rated control supply voltage  
13-14 Output contacts - Closed-circuit principle  
21-22

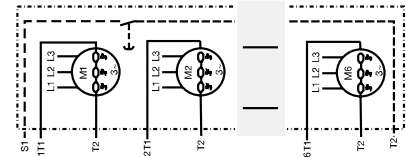

accumulative evaluation = if any input exceeds the threshold, the output relay will trip



# Thermistor motor protection relays

## Ordering details

### Description

The thermistor motor protection relays CM-MSE, CM-MSS and CM-MSN are used to control motors equipped with PTC temperature sensors. The PTC temperature sensors are incorporated in the motor windings to measure the motor heating. This enables direct control and evaluation of various operating conditions. Depending on the products also ATEX approvals for use in hazardous areas are available.

ABB also offers PTC temperature sensors C011 (according to DIN 44081) which are suitable for embedding in motor windings.



CM-MSE



CM-MSS (5)



CM-MSN

### Ordering details

| Rated control supply voltage =<br>measuring voltage | Reference<br>code        | Catalog<br>number | Weight<br>(1 pce)<br>kg (lb) |
|---|--------------------------|-------------------|------------------------------|
| 24 V AC   | CM-MSE                   | 1SVR550805R9300   | 0.11 (0.24)                  |
| 110-130 V AC  |                          | 1SVR550800R9300   | 0.11 (0.24)                  |
| 220-240 V AC  |                          | 1SVR550801R9300   | 0.11 (0.24)                  |
| 24 V AC/DC <sup>1)</sup>                            | CM-MSS (1)               | 1SVR430800R9100   | 0.15 (0.33)                  |
| 220-240 V AC  |                          | 1SVR430801R1100   | 0.15 (0.33)                  |
| 24 V AC/DC <sup>1)</sup>                            | CM-MSS (2)               | 1SVR430810R9300   | 0.15 (0.33)                  |
| 24 V AC   |                          | 1SVR430811R9300   | 0.15 (0.33)                  |
| 110-130 V AC  |                          | 1SVR430811R0300   | 0.15 (0.33)                  |
| 220-240 V AC  | CM-MSS (3)               | 1SVR430811R1300   | 0.15 (0.33)                  |
| 24 V AC/DC <sup>1)</sup>                            |                          | 1SVR430710R9300   | 0.15 (0.33)                  |
| 110-130 V AC  |                          | 1SVR430711R0300   | 0.15 (0.33)                  |
| 220-240 V AC  | CM-MSS (4) <sup>2)</sup> | 1SVR430711R1300   | 0.15 (0.33)                  |
| 380-440 V AC  |                          | 1SVR430711R2300   | 0.15 (0.33)                  |
| 24-240 V AC/DC                                      | CM-MSS (5) <sup>3)</sup> | 1SVR430720R0400   | 0.15 (0.33)                  |
|   | CM-MSS (6)               | 1SVR430720R0300   | 0.15 (0.33)                  |
|   | CM-MSS (7)               | 1SVR430710R0200   | 0.15 (0.33)                  |
|   | CM-MSS (7)               | 1SVR430720R0500   | 0.15 (0.33)                  |
|   | CM-MSN                   | 1SVR450025R0100   | 0.23 (0.51)                  |

<sup>1)</sup> Not electrically isolated

<sup>2)</sup> CM-MSS (4): 1-channel 1 n/c, 1 n/o

<sup>3)</sup> CM-MSS (5): 1-channel 2 c/o

## Thermistor motor protection relays

### Ordering details

### PTC temperature sensors C011

#### Description



The PTC temperature sensors (temperature-dependent with positive temperature coefficient) are selected by the manufacturer of the motor depending on:

- the motor insulation class according to IEC/EN 60034-11,
- the special characteristics of the motor, such as the conductor cross-section of the windings, the permissible overload factor etc.
- special conditions prescribed by the user, such as the permissible ambient temperature, risks resulting from locked rotor, extent of permitted overload etc.

#### Temperature sensor characteristics

One temperature sensor must be embedded in each phase winding. For instance, in case of three-phase squirrel cage motors, three sensors are embedded in the stator windings. For pole-changing motors with one winding (Dahlander connection), 3 sensors are also sufficient. Pole-changing motors with two windings, however, require The sensors are suitable for embedding in motor windings with rated operating voltages of up to 600 V AC. Conductor length: 500 mm per sensor. A 14 V varistor can be connected in parallel to protect the sensors from overvoltage. Due to their characteristics, the thermistor motor protection relays can also be used with PTC temperature sensors of other manufacturers which comply with DIN 44 081 and DIN 44 082 6 sensors.

If an additional warning is required before the motor is switched off, separate sensors for a correspondingly lower temperature must be embedded in the winding. They have to be connected to a second control unit.

#### Ordering details

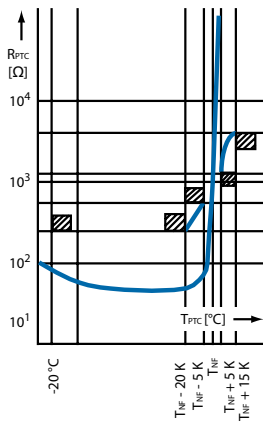

| Rated response temperature $T_{NF}$ | Color Coding | Reference code           | Catalog number  | Weight (1 pce) kg (lb) |
|-------------------------------------|--------------|--------------------------|-----------------|------------------------|
| 70 °C                               | white-brown  | C011-70 <sup>1)</sup>    | GHC0110003R0001 | 0.02 (0.044)           |
| 80 °C                               | white-white  | C011-80 <sup>1)</sup>    | GHC0110003R0002 | 0.02 (0.044)           |
| 90 °C                               | green-green  | C011-90 <sup>1)</sup>    | GHC0110003R0003 | 0.02 (0.044)           |
| 100 °C                              | red-red      | C011-100 <sup>1)</sup>   | GHC0110003R0004 | 0.02 (0.044)           |
| 110 °C                              | brown-brown  | C011-110 <sup>1)</sup>   | GHC0110003R0005 | 0.02 (0.044)           |
| 120 °C                              | gray-gray    | C011-120 <sup>1)</sup>   | GHC0110003R0006 | 0.02 (0.044)           |
| 130 °C                              | blue-blue    | C011-130 <sup>1)</sup>   | GHC0110003R0007 | 0.02 (0.044)           |
| 140 °C                              | white-blue   | C011-140 <sup>1)</sup>   | GHC0110003R0011 | 0.02 (0.044)           |
| 150 °C                              | black-black  | C011-150 <sup>1)</sup>   | GHC0110003R0008 | 0.02 (0.044)           |
| 160 °C                              | blue-red     | C011-160 <sup>1)</sup>   | GHC0110003R0009 | 0.02 (0.044)           |
| 170 °C                              | white-green  | C011-170 <sup>1)</sup>   | GHC0110003R0010 | 0.02 (0.044)           |
| 150 °C                              | black-black  | C011-3-150 <sup>2)</sup> | GHC0110033R0008 | 0.05 (0.11)            |

<sup>1)</sup>Temperature sensor C011, standard version acc. to DIN 44081

<sup>2)</sup>Triple temperature sensor C011-3

# Thermistor motor protection relays

## Technical information

### PTC temperature sensors C011

#### Technical data

##### Characteristic data

|  | Sensor type C011          |
|--|---------------------------|
| Cold-state resistance  | 50 -100 $\Omega$ at 25 °C |
| Warm-state resistance $\pm 5$ up to 6 K of rated response temperature $T_{NF}$ | 10 000 $\Omega$           |
| Thermal time constant, sensor open <sup>1)</sup>                               | < 5 s                     |
| Permitted ambient temperature  | +180 °C                   |

| Rated response temperature w tolerance TNF w iTNF | PTC resistance R from -20 °C to TNF - 20 K | PTC resistance R at PTC temperatures of: |                           |                           |
|---|--|--|---------------------------|---------------------------|
|   |  | TNF - iTNF (UPTC m 2.5 V)                | TNF + iTNF (UPTC m 2.5 V) | TNF + 15 K (UPTC m 7.5 V) |
| 70 $\pm 5$ °C                                     | $\leq 100 \Omega$                          | $\leq 570 \Omega$                        | $\geq 570 \Omega$         | -                         |
| 80 $\pm 5$ °C                                     |  | $\leq 550 \Omega$                        | $\geq 1330 \Omega$        | $\geq 4000 \Omega$        |
| 90 $\pm 5$ °C                                     |  |  |                           |                           |
| 100 $\pm 5$ °C                                    |  |  |                           |                           |
| 110 $\pm 5$ °C                                    |  |  |                           |                           |
| 120 $\pm 5$ °C                                    |  |  |                           |                           |
| 130 $\pm 5$ °C                                    |  |  |                           |                           |
| 140 $\pm 5$ °C                                    |  |  |                           |                           |
| 150 $\pm 5$ °C                                    |  |  |                           |                           |
| 160 $\pm 5$ °C                                    |  | $\leq 570 \Omega$                        | $\geq 570 \Omega$         | -                         |
| 170 $\pm 7$ °C                                    |  |  |                           |                           |

6

<sup>1)</sup> Not embedded in windings.

<sup>2)</sup> For triple temperature sensor take values x 3.

# Thermistor motor protection relays

## Technical data

6

| Type   | CM-MSE  | CM-MSS   | CM-MSN   |
|--|---|--|--|
| <b>Input circuit</b>   |   |  |  |
| Rated control supply voltage $U_s$                                   | A1-A2   | 24 V AC approx. 1.5 VA   |  |
| power consumption  | A1-A2   | 24 V AC/DC approx. 1.1 VA / 0.6 W  |  |
|  | A1-A2   | 110-130 V AC approx. 1.5 VA  |  |
|  | A1-A2   | 220-240 V AC approx. 1.5 VA  |  |
|  | A1-A2   | 380-440 V AC approx. 1.7 VA  |  |
|  | A1-A2   | 24-240 V AC/DC approx. 1.4-1.7 W / approx. 3.5-5.7 VA  |  |
| Rated control supply voltage $U_s$ tolerance                         |   | -15 % ... +10 %  |  |
| Rated frequency  |   | AC: 50-60 Hz / 24-240 V AC/DC versions: 15-400 Hz  |  |
| Duty time  |   | 100 %  |  |
| <b>Measuring circuit</b>   |   |  |  |
| Monitoring function  | T1-T2   | T1-T2/T2x, 1T1...6T1-T2  | 1T1...6T1-T2   |
| Number of sensor circuits  | 1   | 1, 2 oder 3 (see order details)  | 6  |
| Short-circuit monitoring   | -   | see ordering details   | yes  |
| Non-volatile fault storage   | -   | see ordering details   | configurable   |
| Test function  | -   | see ordering details   | yes  |
| <b>Sensor circuit</b>  |   |  |  |
| Temperature threshold (relay de-energizes)                           | 2.7-3.7 k $\Omega$  | CM-MSS (1+2): 3050 $\pm$ 550 $\Omega$  | 3.6 k $\Omega$ $\pm$ 5 %   |
| Temperature hysteresis (relay energizes)                             | 1.7-2.3 k $\Omega$  | CM-MSS (3-7): 3.6 k $\Omega$ $\pm$ 5 %<br>CM-MSS (1+2): 1900 $\pm$ 400 $\Omega$<br>CM-MSS (3-7): 1.6 k $\Omega$ $\pm$ 5 %  | 1.6 k $\Omega$ $\pm$ 5 %   |
| Short-circuit threshold (relay de-energizes)                         |   | <18 $\Omega$   |  |
| Short-circuit hysteresis (relay energizes)                           |   | >45 $\Omega$   |  |
| Maximum total resistance of sensors connected in series (cold state) |   | $\leq$ 1.5 k $\Omega$  |  |
| Maximum sensor cable length for short-circuit detection              |   | 2 x 100 m at 0.75 mm <sup>2</sup> , 2 x 400 m at 2.5 mm <sup>2</sup>   |  |
| Response time  |   | <100 ms  |  |
| <b>Control circuit for storage and hysteresis function</b>           |   |  |  |
| Remote reset   | S1-T2 or S1/X1-S2/X2  | -  | n/o contact  |
| Maximum no-load voltage  |   |  | approx. 25 V, 24-240 V; AC/DC versions: 5.5 V                                  |
| Maximum cable length   |   |  | $\leq$ 50 m, 100-200 m if shielded   |
| <b>Indication of operational states</b>                              |   |  |  |
| Control supply voltage   | U: green LED  | -  | L: control supply voltage applied  |
| Fault indication   | F: red LED  | -  | L: output relay de-energized   |
| <b>Output circuits</b>   |   |  |  |
| Kind of output   | 13-14   | 11-12/14, 21-22/24, 13-14, 21-22   | 13-14, 21-22   |
| Operational principle  | 1 n/o contact   | CM-MSS (1): 1 c/o contact<br>CM-MSS (2,3,5): 2 c/o contacts<br>CM-MSS (4, 7): 1 n/o + 1 n/c<br>CM-MSS (6): 2x1 c/o contact | 1 n/o + 1 n/c contact  |
| Contact material   | AgCdO   | CM-MSS (1+2+6): AgCdO<br>CM-MSS (3+4+5+7): AgNi  | AgNi   |
| Rated voltage (VDE 0110, IEC 664-1, IEC 60947-1)                     |   | 250 V  |  |
| Maximum switching voltage  |   | 250 V  |  |
| Rated operational current $I_o$ (IEC/EN 60947-5-1)                   | AC12 (resistive) at 230 V<br>AC15 (inductive) at 230 V<br>DC12 (resistive) at 24 V<br>DC13 (resistive) at 24 V  | 4 A<br>3 A<br>4 A<br>2 A (1.5 A - n/c contact <sup>1)</sup> )  |  |
| AC rating (UL 508)   | Utilization category (Control Circuit Rating Code)<br>max. rated operational voltage<br>max. continuous thermal current at B 300<br>max. making/breaking apparent power at B300 | 300 V AC<br>5 A<br>3600/360 VA   |  |
| Mechanical lifetime  |   | 30 (10 <sup>11</sup> ) x 10 <sup>9</sup> switching cycles  |  |
| Electrical lifetime (AC12, 230 V, 4 A)                               |   | 0.1 x 10 <sup>6</sup> switching cycles   |  |
| Max. fuse rating to achieve short-circuit protection                 | n/c contact<br>n/o contact  | 10 A fast-acting<br>10 A fast-acting   | 4 A (10 A <sup>1)</sup> ) fast-acting<br>6 A (10 A <sup>1)</sup> ) fast-acting |
|  |   |  | 10 A fast-acting<br>10 A fast-acting   |
| <b>General data</b>  |   |  |  |
| Dimensions (W x H x D)   | 22.5 x 78 x 78.5 mm<br>(0.89 x 3.07 x 3.09 in)  | 22.5 x 78 x 100 mm<br>(0.89 x 3.07 x 3.94 in)  | 45 x 78 x 100 mm<br>(1.77 x 3.07 x 3.94 in)                                    |
| Weight   | approx. 0.11 kg (0.24 lb)   | approx. 0.15 kg (0.33 lb)  | approx. 0.23 kg (0.51 lb)  |
| Mounting position  |   | any  |  |
| Degree of protection   | housing / terminals   | IP50 / IP20  |  |
| Ambient temperature range  | operation   | -20...+60 $^{\circ}$ C   | -25...+65 $^{\circ}$ C   |
|  | storage   | -40...+85 $^{\circ}$ C   |  |
| Mounting   |   | DIN rail (IEC/EN 60715)  |  |

<sup>1)</sup> 1SVR 430 710 R 0200, 1SVR 430 8xx R xxxx

# Thermistor motor protection relays

## Technical data

Measuring &  
monitoring relays  
CM Range

| Type  |                                      | CM-MSE   | CM-MSS | CM-MSN  |
|---|--------------------------------------|--|--------|---|
| <b>Electrical connection</b>                                  |                                      |  |        |   |
| Wire size   | fine strand with wire end ferrule    | 2 x 1.5 mm <sup>2</sup><br>(2 x 16 AWG)                  |        | 2 x 2.5 mm <sup>2</sup><br>(2 x 14 AWG)         |
|   | fine strand without wire end ferrule | 2 x 0.75-1.5 mm <sup>2</sup><br>(2 x 18-16 AWG)          |        | 2 x 0.75-2.5 mm <sup>2</sup><br>(2 x 18-14 AWG) |
|   | rigid                                | 2 x 1-1.5 mm <sup>2</sup><br>(2 x 18-16 AWG)             |        | 2 x 0.75-2.5 mm <sup>2</sup><br>(2 x 18-14 AWG) |
| Stripping length  |                                      | 2 x 0.75-1.5 mm <sup>2</sup><br>(2 x 18-16 AWG)          |        | 2 x 0.5-4 mm <sup>2</sup><br>(2 x 20-12 AWG)    |
| Tightening torque   |                                      | 10 mm (0.39 inch)  |        | 7 mm (0.28 inch)                                |
| <b>Standards</b>  |                                      |  |        |   |
| Product standard  |                                      | IEC 255-6, EN 60255-6                                    |        |   |
| Low Voltage Directive   |                                      | 2006/95/EC   |        |   |
| EMC Directive   |                                      | 2004/108/EC, 91/263/EEC, 92/31/EEC, 93/68/EEC, 93/67/EEC |        |   |
| <b>Electromagnetic compatibility</b>                          |                                      |  |        |   |
| electrostatic discharge                                       | IEC/EN 61000-4-2                     | EN 61000-6-2, EN 61000-6-4                               |        |   |
| radiated, radio-frequency, electromagnetic field              | IEC/EN 61000-4-3                     | Level 3 (6 kV / 8 kV)                                    |        |   |
| electrical fast transient /burst                              | IEC/EN 61000-4-4                     | Level 3 (10 V/m)   |        |   |
| surge   | IEC/EN 61000-4-5                     | Level 3 (2 kV / 5 kHz)                                   |        |   |
| conducted disturbances, induced by radio-frequency fields     | IEC/EN 61000-4-6                     | Level 3/4 (1/2 kV)                                       |        |   |
| Operational reliability (IEC 68-2-6)                          |                                      | 6 g  | 4 g    | 5 g   |
| Resistance to vibration (IEC 68-2-6)                          |                                      | 10 g   | 6 g    | 10 g  |
| Environmental testing (IEC 68-2-30)                           |                                      | 24 h cycle time, 55 °C, 93 % rel., 96 h                  |        |   |
| <b>Isolation data</b>   |                                      |  |        |   |
| Rated voltage between supply, measuring and output circuit    |                                      | 250 V  |        |   |
| Rated impulse withstand voltage between all isolated circuits |                                      | 4 kV / 1.2 - 50 µs                                       |        |   |
| Test voltage between all isolated circuits                    |                                      | 2.5 kV, 50 Hz, 1 min.                                    |        |   |
| Pollution degree  |                                      | 3  |        |   |
| Overvoltage category  |                                      | III  |        |   |

6

## Notes

# CM-E Range Temperature monitoring relays



Temperature monitoring relays





## New range of temperature monitoring relays CM-TCS

The new CM-TCS temperature monitoring relays replace the existing C510 and C511 range. The number of models has been reduced in order to make selection and stocking easier. All products now feature over-temperature and under-temperature monitoring. Also, units are now configurable to open or closed circuit principle.

**6** The temperature monitoring relays CM-TCS monitor overtemperature, undertemperature or temperatures between threshold values (window monitoring) with PT100 sensor. As soon as the temperature falls below or exceeds the threshold value the output relays change their positions according to the configured functionality and the front-face LED's display the current status.

#### Characteristics CM-TCS

- Adjustable sensor type: PT100
- Functionality like overtemperature monitoring, undertemperature monitoring, temperature window monitoring configurable
- All configurations and adjustments by front-face operating elements
- Precise adjustment with direct reading scales
- One or two threshold values
- Hysteresis 2...20 % adjustable
- Operating temperature range -40...+60 °C
- 1 x 2 c/o or 2 x 1 c/o configurable
- Open- or closed-circuit principle configurable
- Short-circuit monitoring and interrupted wire detection
- 22.5 mm (0.89 in) width
- LED's for status indication

#### Characteristics C512 + C513

- Adjustable sensor types: PT100, PT1000, KTY83, KTY84, NTC-B57227-K333-A1
- Measuring principle for 2-wire and 3-wire sensors
- Temperature monitor for 1-3 sensor circuits
- Adjustable over-, undertemperature monitoring or range monitoring function
- 2 thresholds
- Hysteresis for both thresholds (1-99 Kelvin)
- Adjustable time delay from 0-999 s affects to both thresholds
- Storage function selectable via external signal (Y1-Y2)
- Non volatile storage of parameter settings
- 1 n/o (for wire-break and short-circuit detection) and 2 c/o
- Multifunctional digital display
- 3 LED's for status indication
- Open- or closed-circuit principle selectable
- 45 mm wide housing with 24 terminals

#### C512

- Temperature monitor for 1 sensor circuit

#### C513

- Temperature monitor for 1-3 sensor circuits
- In the 3-sensor version the status of the single sensors is displayed if the temperature exceeds or falls below the threshold.

This way it can be easily determined which one of the connected sensors has exceeded or dropped below either one or both threshold values.



# Temperature monitoring relays

## Selection and conversion

NEW

Measuring & monitoring relays  
CM Range

|  | Reference code | Catalog number | 1SVR630740R9100 | 1SVR630740R0100 | 1SVR630740R9200 | 1SVR630740R0200 | 1SVR630740R9300 | 1SVR630740R0300 | C512-24 | C512-W | C513-W                               |
|--|----------------|----------------|-----------------|-----------------|-----------------|-----------------|-----------------|-----------------|---------|--------|--------------------------------------|
| <b>Rated control supply voltage <math>U_s</math></b> |                |                |                 |                 |                 |                 |                 |                 |         |        |                                      |
| 24 V AC/DC   |                |                | ■               |                 |                 | ■               |                 |                 | ■       |        |                                      |
| 24-240 V AC/DC                                       |                |                | ■               |                 | ■               |                 | ■               |                 |         | ■      | ■                                    |
| <b>Technology</b>                                    |                |                |                 |                 |                 |                 |                 |                 |         |        |                                      |
| analogue   |                |                | ■               | ■               | ■               | ■               | ■               | ■               |         |        |                                      |
| digital  |                |                |                 |                 |                 |                 |                 |                 | ■       | ■      | ■                                    |
| <b>Sensor circuits (2 or 3 wire)</b>                 |                |                |                 |                 |                 |                 |                 |                 |         |        |                                      |
| no of temperature sensors                            |                |                | 1               | 1               | 1               | 1               | 1               | 1               | 1       | 1      | 3                                    |
| no of thresholds                                     |                |                | 2               | 2               | 2               | 2               | 2               | 2               | 2       | 2      | 3                                    |
| <b>Sensor type</b>                                   |                |                |                 |                 |                 |                 |                 |                 |         |        |                                      |
| PT100  |                |                | ■               | ■               | ■               | ■               | ■               | ■               | ■       | ■      | ■                                    |
| PT100, KTY83, KTY84, NTC                             |                |                |                 |                 |                 |                 |                 |                 | ■       | ■      | ■                                    |
| <b>Measuring temperature range</b>                   |                |                |                 |                 |                 |                 |                 |                 |         |        |                                      |
| -50...+50 °C   |                |                | ■               | ■               |                 |                 |                 |                 |         |        |                                      |
| 0...+100 °C  |                |                |                 |                 | ■               | ■               |                 |                 |         |        |                                      |
| 0...+200 °C  |                |                |                 |                 |                 |                 | ■               | ■               |         |        |                                      |
| -50...+500 °C  |                |                |                 |                 |                 |                 |                 |                 | ■       | ■      | ■                                    |
| <b>Monitoring function</b>                           |                |                |                 |                 |                 |                 |                 |                 |         |        |                                      |
| overtemperature                                      |                |                | ■               | ■               | ■               | ■               | ■               | ■               | ■       | ■      | ■                                    |
| undertemperature                                     |                |                | ■               | ■               | ■               | ■               | ■               | ■               | ■       | ■      | ■                                    |
| window temperature                                   |                |                | ■               | ■               | ■               | ■               | ■               | ■               | ■       | ■      | ■                                    |
| <b>Operating principle</b>                           |                |                |                 |                 |                 |                 |                 |                 |         |        |                                      |
| open or closed principle                             |                |                | ■               | ■               | ■               | ■               | ■               | ■               | ■       | ■      | ■                                    |
| <b>Output contacts</b>                               |                |                |                 |                 |                 |                 |                 |                 |         |        |                                      |
| n/o  |                |                |                 |                 |                 |                 |                 |                 | 1       | 1      | 1                                    |
| c/o  |                |                | 2               | 2               | 2               | 2               | 2               | 2               | 2       | 2      | 2                                    |
| <b>Conversion</b>                                    |                |                |                 |                 |                 |                 |                 |                 |         |        |                                      |
| 1SAR700001R0005                                      | C510.01-24     | 24 V AC/DC     | ■               |                 |                 |                 |                 |                 |         |        | no device with pure 230 V AC supply. |
| 1SAR700001R0006                                      | C510.01-K      | 110/230 V AC   |                 | ■               |                 |                 |                 |                 |         |        | no device with pure 230 V AC supply. |
| 1SAR700002R0005                                      | C510.02-24     | 24 V AC/DC     |                 |                 | ■               |                 |                 |                 |         |        | no device with pure 230 V AC supply. |
| 1SAR700002R0006                                      | C510.02-K      | 110/230 V AC   |                 |                 |                 | ■               |                 |                 |         |        | no device with pure 230 V AC supply. |
| 1SAR700003R0005                                      | C510.03-24     | 24 V AC/DC     |                 |                 |                 |                 | ■               |                 |         |        | no device with pure 230 V AC supply. |
| 1SAR700003R0006                                      | C510.03-K      | 110/230 V AC   |                 |                 |                 |                 |                 | ■               |         |        | no device with pure 230 V AC supply. |
| 1SAR700004R0005                                      | C510.11-24     | 24 V AC/DC     | ■               |                 |                 |                 |                 |                 |         |        | no device with pure 230 V AC supply. |
| 1SAR700004R0006                                      | C510.11-K      | 110/230 V AC   |                 | ■               |                 |                 |                 |                 |         |        | no device with pure 230 V AC supply. |
| 1SAR700005R0005                                      | C510.12-24     | 24 V AC/DC     |                 |                 | ■               |                 |                 |                 |         |        | no device with pure 230 V AC supply. |
| 1SAR700005R0006                                      | C510.12-K      | 110/230 V AC   |                 |                 |                 | ■               |                 |                 |         |        | no device with pure 230 V AC supply. |
| 1SAR700006R0005                                      | C510.13-24     | 24 V AC/DC     |                 |                 |                 |                 | ■               |                 |         |        | no device with pure 230 V AC supply. |
| 1SAR700006R0006                                      | C510.13-K      | 110/230 V AC   |                 |                 |                 |                 |                 | ■               |         |        | no device with pure 230 V AC supply. |
| 1SAR700011R0005                                      | C511.01-24     | 24 V AC/DC     | ■               |                 |                 |                 |                 |                 |         |        |                                      |
| 1SAR700011R0006                                      | C511.01-W      | 24-240 V AC/DC |                 | ■               |                 |                 |                 |                 |         |        |                                      |
| 1SAR700012R0005                                      | C511.02-24     | 24 V AC/DC     |                 |                 | ■               |                 |                 |                 |         |        |                                      |
| 1SAR700012R0006                                      | C511.02-W      | 24-240 V AC/DC |                 |                 |                 | ■               |                 |                 |         |        |                                      |
| 1SAR700013R0005                                      | C511.03-24     | 24 V AC/DC     |                 |                 |                 |                 | ■               |                 |         |        |                                      |
| 1SAR700013R0010                                      | C511.03-W      | 24-240 V AC/DC |                 |                 |                 |                 |                 | ■               |         |        |                                      |
| 1SAR700016R0005                                      | C511.11-24     | 24 V AC/DC     | ■               |                 |                 |                 |                 |                 |         |        |                                      |
| 1SAR700016R0010                                      | C511.11-W      | 24-240 V AC/DC |                 | ■               |                 |                 |                 |                 |         |        |                                      |
| 1SAR700016R0005                                      | C511.12-24     | 24 V AC/DC     |                 |                 | ■               |                 |                 |                 |         |        |                                      |
| 1SAR700016R0010                                      | C511.12-W      | 24-240 V AC/DC |                 |                 |                 | ■               |                 |                 |         |        |                                      |
| 1SAR700016R0005                                      | C511.13-24     | 24 V AC/DC     |                 |                 |                 |                 | ■               |                 |         |        |                                      |
| 1SAR700016R0010                                      | C511.13-W      | 24-240 V AC/DC |                 |                 |                 |                 |                 | ■               |         |        |                                      |

## Temperature monitoring relays

### Ordering details



#### Description

Acquisition, messaging and regulation of temperatures of solid, liquid and gaseous media in processes and machines via PT100, PT1000, KTY83, KTY84 or NTC sensors.

ABB offers different temperature monitoring relays to meet the needs of your application:



CM-TCS



C512, C513

#### Ordering details - Temperature monitoring relays

| Rated control supply voltage | Measuring range  | Reference code          | Catalog number  | Weight (1 pce)<br>kg (lb) |
|------------------------------|------------------|-------------------------|-----------------|---------------------------|
| 24-240 V AC/DC               | -50...+50 °C     | CM-TCS.11 <sup>1)</sup> | 1SVR630740R0100 | 0.127 (0.281)             |
|                              | 0...+100 °C      | CM-TCS.12 <sup>1)</sup> | 1SVR630740R0200 | 0.127 (0.281)             |
|                              | 0...+200 °C      | CM-TCS.13 <sup>1)</sup> | 1SVR630740R0300 | 0.127 (0.281)             |
| 24 V AC/DC                   | -50...+50 °C     | CM-TCS.21 <sup>1)</sup> | 1SVR630740R9100 | 0.141 (0.310)             |
|                              | 0...+100 °C      | CM-TCS.22 <sup>1)</sup> | 1SVR630740R9200 | 0.141 (0.310)             |
|                              | 0...+200 °C      | CM-TCS.23 <sup>1)</sup> | 1SVR630740R9300 | 0.141 (0.310)             |
| 24 V AC/DC                   | -50...+500 °C *) | C512-24 <sup>2)</sup>   | 1SAR700100R0005 | 0.32 (0.71)               |
| 24-240 V AC/DC               |                  | C512-W <sup>2)</sup>    | 1SAR700100R0010 | 0.33 (0.73)               |
| 24-240 V AC/DC               |                  | C513-W <sup>2)</sup>    | 1SAR700110R0010 | 0.34 (0.75)               |

<sup>1)</sup> PT100 sensors, 2 or 3 wire connection, 2 thresholds adjustable

<sup>2)</sup> PT100, PT1000, KTY83, KTY84, NTC-B57227-K333-A1, 2 or 3 wire connection, 2 thresholds, multifunctional display.

Open or closed circuit principle adjustable, 1 n/o, 2 c/o contacts

(Typ Siemens Matsushita B57272-A333-A1 - 100 °C: 1.8 kΩ, 25 °C: 32.762 kΩ)

#### Ordering details - New range temperature monitoring relays

| Rated control supply voltage | Measuring range | Reference code | Catalog number  | Weight (1 pce)<br>kg (lb) |
|------------------------------|-----------------|----------------|-----------------|---------------------------|
| 24-240 V AC/DC               | -50...+50 °C    | CM-TCS.11S     | 1SVR730740R0100 | 0.151 (0.333)             |
|                              |                 | CM-TCS.11P     | 1SVR740740R0100 | 0.140 (0.309)             |
|                              | 0...+100 °C     | CM-TCS.12S     | 1SVR730740R0200 | 0.151 (0.333)             |
|                              |                 | CM-TCS.12P     | 1SVR740740R0200 | 0.140 (0.309)             |
|                              | 0...+200 °C     | CM-TCS.13S     | 1SVR730740R0300 | 0.151 (0.333)             |
|                              |                 | CM-TCS.13P     | 1SVR740740R0300 | 0.140 (0.309)             |
| 24 V AC/DC                   | -50...+50 °C    | CM-TCS.21S     | 1SVR730740R9100 | 0.138 (0.304)             |
|                              |                 | CM-TCS.21P     | 1SVR740740R9100 | 0.127 (0.280)             |
|                              | 0...+100 °C     | CM-TCS.22S     | 1SVR730740R9200 | 0.138 (0.304)             |
|                              |                 | CM-TCS.22P     | 1SVR740740R9200 | 0.127 (0.280)             |
|                              | 0...+200 °C     | CM-TCS.23S     | 1SVR730740R9300 | 0.138 (0.304)             |
|                              |                 | CM-TCS.23P     | 1SVR740740R9300 | 0.127 (0.280)             |

#### Ordering details - Replaceable cover marking for digital devices

| Use for | Language | Reference code | Catalog number  | Weight (1 pce)<br>kg (lb) |
|---------|----------|----------------|-----------------|---------------------------|
| C512    | German   | C512-D         | 1SVR700101R0100 |                           |
| C512    | English  | C512-E         | 1SVR700102R0100 |                           |
| C513    | German   | C513-D         | 1SVR700111R0100 |                           |
| C513    | English  | C513-E         | 1SVR700112R0100 |                           |

\*) The measuring range depends on the used sensor type:

- PT100: -50...+500 °C
- PT1000: -50...+500 °C
- NTC: +80...+160 °C
- KTY83: -50...+175 °C
- KTY84: -40...+300 °C

(Typ Siemens Matsushita B57272-A333-A1 - 100 °C: 1.8 kΩ, 25 °C: 32.762 kΩ)

# Temperature monitoring relays

## Overview, functional description and diagrams

NEW

### Overview

The temperature monitoring relays can be used for temperature measurement in solid, liquid and gaseous media. The temperature is acquired by the sensor in the medium, evaluated by the device and monitored to determine whether it is within an operating range (range monitoring function) or has exceeded or fallen below a threshold.

### Functional description

#### CM-TCS

The temperature monitoring relays CM-TCS monitor overtemperature, undertemperature, or temperatures between two threshold values (window monitoring) with PT100 sensor. As soon as the temperature falls below or exceeds the threshold value the output relays change their positions according to the configured functionality and the front-face LEDs display the current status. Regardless of the selected configuration, the device is monitoring its measuring circuit for interrupted wires or short-circuits.

#### DIP switches

| Position | 4       | 3      | 2 | 1 |
|----------|---------|--------|---|---|
| ON †     | 2x1 c/o | closed |   |   |
| OFF      | 1x2 c/o | open   |   |   |

### Function diagrams

#### CM-TCS - Overvoltage

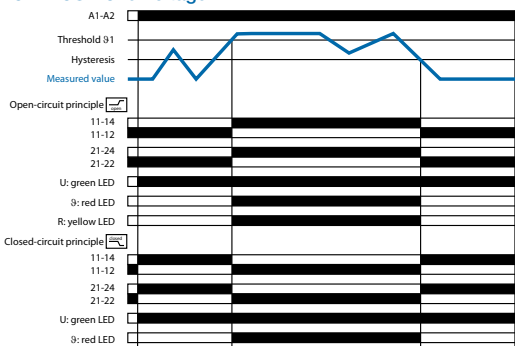

#### CM-TCS - Undervoltage

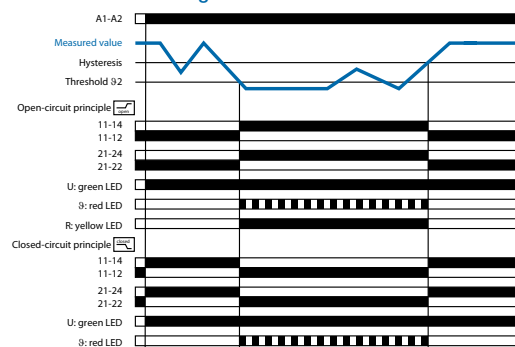

#### CM-TCS - Temperature monitoring

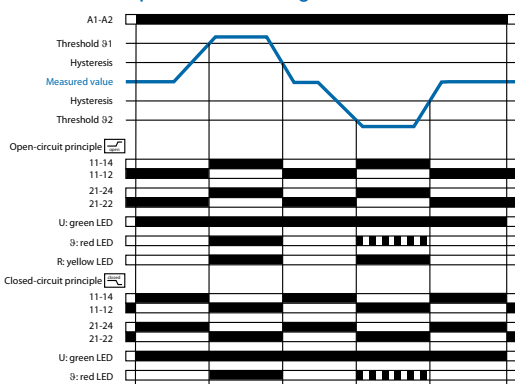

|  | ON  | OFF (default)  |
|--|---|--|
| DIP switch 1<br>Monitoring principle                     | Overtemperature monitoring<br>If overtemperature monitoring is selected, the CM-TCS recognizes temperatures above the selected threshold and trips the output relay according to the selected operating principle.    | Undertemperature monitoring<br>If undertemperature monitoring is selected, the CM-TCS recognizes temperatures below the selected threshold and trips the output relay according to the selected operating principle.   |
| DIP switch 2<br>Temperature window monitoring            | Temperature window monitoring activated<br>If temperature window monitoring is selected, the CM-TCS monitors over- and undertemperature. If temperature window monitoring is activated, DIP switch 1 is disabled.     | Temperature window monitoring de-activated<br>Temperature window monitoring is de-selected.  |
| DIP switch 3<br>Operating principle of the output relays | Closed-circuit principle<br>If closed-circuit principle is selected, the output relays are energized. They de-energize if a fault is occurring.   | Open-circuit principle<br>If open-circuit principle is selected, the output relays are deenergized. They energize if a fault is occurring.   |
| DIP switch 4<br>2 x 1 c/o contact, 1 x 2 c/o contacts    | 2 x 1 c/o (SPDT) contact<br>If operating principle 2 x 1 c/o contact is selected, the output relay R1 (11-12/14) reacts to threshold value $t_1$ and the output relay R2 (21-22/24) reacts to threshold value $t_2$ . | 1 x 2 c/o (SPDT) contacts<br>If operating principle 1 x 2 c/o contacts is selected, both output relays R1 (11-12/14) and R2 (21-22/24) react synchronously to one threshold value.<br>Overtemperature monitoring: Settings of the threshold value $t_2$ have no effect on the operation.<br>Undertemperature monitoring: Settings of the threshold values $t_2$ have no effect on the operation. |

# Temperature monitoring relays

## Overview, functional description and diagrams

NEW

### Functional description

#### Digital tripping devices

Once the temperature has reached the set threshold of  $u_1$ , output relay K1 changes its switching state after the set time delay  $t$  has elapsed (K2 reacts in the same way for  $u_2$ ).

6

### Characteristic curves of resistance sensors

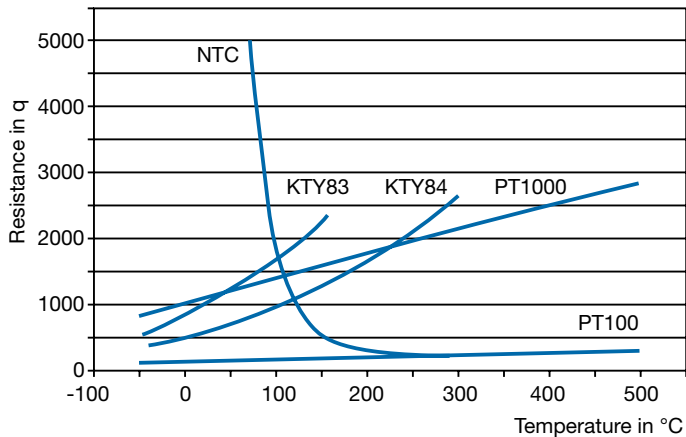

### Function diagrams

#### Overtemperature - C512/C513

Open-circuit principle

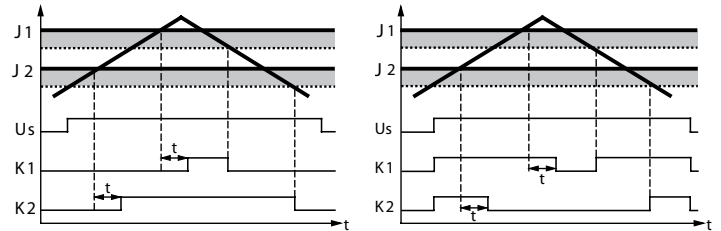

#### Undertemperature - C512/C513

Open-circuit principle

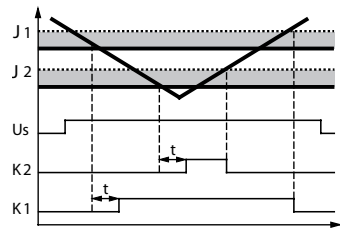

Closed-circuit principle

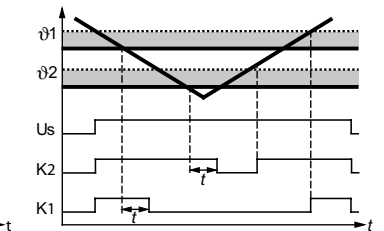

#### Range monitoring - C512/C513

Open-circuit principle

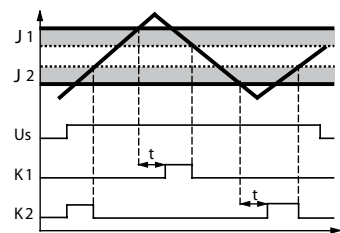

Closed-circuit principle

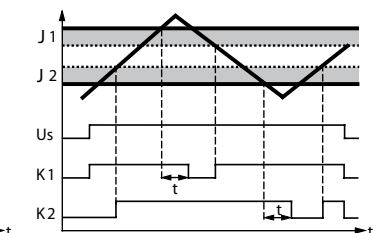

#### Function principle with storage function - C512/C513

using overtemperature with closed-circuit principle as an example

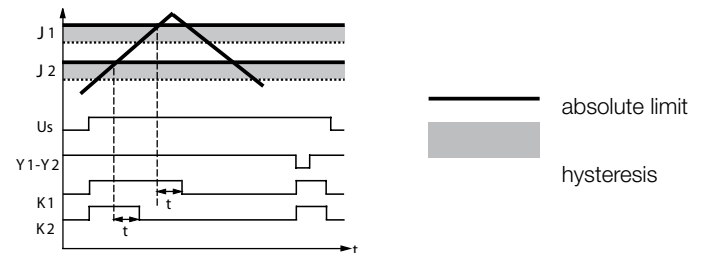

**NEW**

# Temperature monitoring relays

Connection diagrams, resistance thermometer sensors

## Connection diagrams

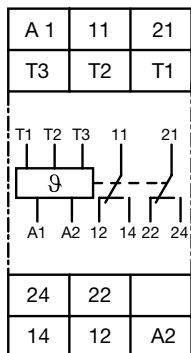

### CM-TCS

- A1-A2 Control supply voltage
- 11-12/14 Output relay R1
- 21-22/24 Output relay R2
- T1, T2, T3 Measuring input, connection PT100

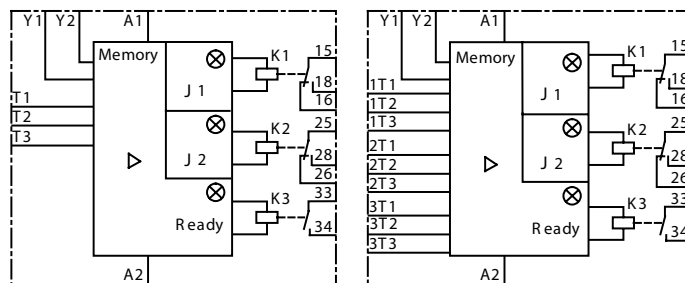

### C512

- A1-A2 Rated control supply voltage
- 15-16/18 Output contacts
- 25-26/28 Output contacts
- 33-34 Output contacts
- T1-T3 Sensor connection
- Y1-Y2 Connection for storage bridge
- A1-A2 Rated control supply voltage
- 15-16/18 Output contacts
- 25-26/28 Output contacts
- 33-34 Output contacts
- 1T1-1T3 Sensor connection 1
- 2T1-2T3 Sensor connection 2
- 3T1-3T3 Sensor connection 3
- Y1-Y2 Connection for storage bridge

## Connection of resistance thermometer sensors

### 2-wire measurement

When using 2-wire temperature sensors the sensor resistance and the wire resistance are added together.

The resulting systematic errors must be taken into account when adjusting the tripping device.

A jumper must be connected between the terminals T2 and T3.

The following table can be used for PT100 sensors to determine the temperature errors caused by the line length.

When using resistance sensors with two-wire connection a bridge must be inserted between terminals T2 and T3.

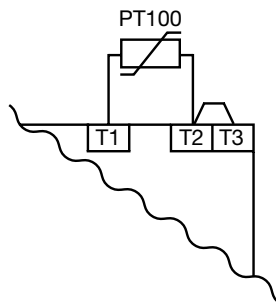

### 3-wire measurement

To minimize the influence of the wire resistance, a three-wire connection is usually used.

By means of the additional wire two measuring circuits are created. One of these two circuits is used for reference. This way, the tripping device can calculate and take into account the wire resistance automatically.

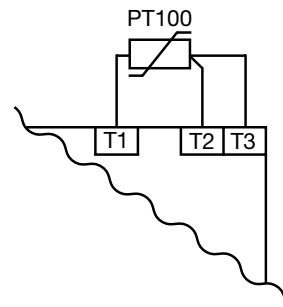

### Error caused by the line

The error resulting from the line resistance amounts to approx. 2.5 Kelvin/Ohm. If the resistance of the line is not known and it is not possible to measure it, the error caused by the line can be estimated using the following table.

### Temperature error

(depending on the line length and conductor cross section for PT100 sensors at an ambient temperature of 20 °C, in K)

| Line length in m | Wire size mm <sup>2</sup> |      |      |      |
|------------------|---------------------------|------|------|------|
|                  | 0.50                      | 0.75 | 1    | 1.5  |
| 0                | 0.0                       | 0.0  | 0.0  | 0.0  |
| 10               | 1.8                       | 1.2  | 0.9  | 0.6  |
| 25               | 4.5                       | 3.0  | 2.3  | 1.5  |
| 50               | 9.0                       | 6.0  | 4.5  | 3.0  |
| 75               | 13.6                      | 9.0  | 6.8  | 4.5  |
| 100              | 18.1                      | 12.1 | 9.0  | 6.0  |
| 200              | 36.3                      | 24.2 | 18.1 | 12.1 |
| 500              | 91.6                      | 60.8 | 45.5 | 30.2 |

| Type   |       | CM-TCS.11/12/13                                 | CM-TCS.21/22/23  |
|--|-------|---|--|
| <b>Input circuit</b>                                       |       |   |  |
| Rated control supply voltage                               | $U_s$ | A1-A2   | 24-240 V AC/DC   |
| Rated control supply voltage $U_s$ tolerance               |       |   | -15...+10 %  |
| Typical current / power / consumption                      |       |   |  |
|  |       | 24 V DC   | 33 mA / 0.8 VA   |
|  |       | 115 V AC  | 12.5 mA / 1.5 VA   |
|  |       | 230 V AC  | 13 mA / 2.9 VA   |
| Rated frequency  |       | AC  | 13.5-440 Hz  |
| Frequency range  |       | AC  | 13.5-440 Hz  |
| Power failure buffering time                               |       | min.  | 20 ms  |
|  |       |   | 24 V AC/DC   |
|  |       |   | 18 mA / 0.45 VA  |
|  |       |   | n/a  |
|  |       |   | n/a  |
|  |       |   | 50/60 Hz   |
|  |       |   | 45-65 Hz   |
| <b>6 Measuring circuit</b>                                 |       |   |  |
| Sensor type  |       |   | T1, T2, T3   |
| Connection of the sensor                                   |       |   | PT100  |
|  |       | 2-wire  | yes, jumper between T2-T3                                  |
|  |       | 3-wire  | yes, use terminal T1, T2, T3                               |
| Monitoring function  |       |   | overtemperature, undertemperature or window monitoring     |
| Threshold values adjustable within the measuring range     |       | CM-TCS.x1                                       | -50...+50 °C   |
|  |       | CM-TCS.x2                                       | 0...+100 °C  |
|  |       | CM-TCS.x3                                       | 0...+200 °C  |
| Number of possible thresholds                              |       |   | 2  |
| Tolerance of the adjusted threshold value                  |       |   | typ. ±5 % of the range end value                           |
| Hysteresis related to the threshold value                  |       |   | 2-20 % of threshold value, min. 1 °C                       |
| Measuring principle  |       |   | continuous current   |
| Typical current in the sensor circuit                      |       |   | 0.8 mA   |
| Interrupted wire detection                                 |       |   | yes, indicated via LED status                              |
| Short-circuit detection                                    |       |   | yes, indicated via LED status                              |
| Accuracy within the rated control supply voltage tolerance |       |   | < 0.2 °C / or < 0.01 %/K                                   |
| Accuracy within the temperature range                      |       |   | < 0.2 °C / or < 0.01 %/K                                   |
| Repeat accuracy (constant parameters)                      |       |   | < 0.2 % of full scale                                      |
| Maximum measuring cycle                                    |       |   | 320 ms   |
| <b>Output circuit</b>                                      |       |   |  |
| Kind of output   |       |   | 2 x 1 or 1 x 2 c/o (SPDT) contacts configurable            |
| Operating principle <sup>1)</sup>                          |       |   | open- or closed-circuit principle configurable             |
| Contact material   |       |   | AgNi alloy, Cd free  |
| Rated voltage (VDE 0110, IEC 60947-1)                      |       |   | 250 V AC / 300 V DC  |
| Minimum switching voltage / Minimum switching current      |       |   | 24 V / 10 mA   |
| Maximum switching voltage / Maximum switching current      |       |   | see 'Load limit curves'                                    |
| Rated operating current $I_n$ (IEC/EN 60947-1-5)           |       | AC12 (resistive) 230 V                          | 4 A  |
|  |       | AC15 (inductive) 230 V                          | 3 A  |
|  |       | DC12 (resistive) 24 V                           | 4 A  |
|  |       | DC13 (inductive) 24 V                           | 2 A  |
| AC Rating (UL508)  |       | utilization category                            | B 300, pilot duty general purpose (250 V, 4 A, cos φ 0.75) |
|  |       | maximum rated operational voltage               | 250 V AC   |
|  |       | maximum continuous thermal current at B 300     | 4 A  |
|  |       | maximum making/breaking apparent power at B 300 | 3600/360 VA  |
| Mechanical lifetime  |       |   | 30 x 10 <sup>6</sup> switching cycles                      |
| Electrical lifetime ((AC12, 230 V, 4 A)                    |       |   | 0.1 x 10 <sup>6</sup> switching cycles                     |
| Maximum fuse rating to achieve short-circuit protection    |       | n/c contact                                     | 6 A fast-acting  |
|  |       | n/o contact                                     | 10 A fast-acting   |
| Conventional thermal current $I_{th}$ acc. IEC/EN 60947-1  |       |   | 4 A  |
| <b>General data</b>  |       |   |  |
| Dimensions (W x H x D)                                     |       |   | 22.5 x 78 x 100 mm (0.89 x 3.07 x 3.94 in)                 |
| Mounting position  |       |   | any  |
| Weight   |       | net weight                                      | 0.141 kg (0.310 lb)  |
|  |       | gross weight                                    | 0.166 kg (0.336 lb)  |
|  |       | enclosure / terminals                           | IP50 / IP20  |
| Degree of protection                                       |       | operation                                       | -40...+60 °C   |
| Ambient temperature range                                  |       | storage/transport                               | -40...+85 °C   |
| Mounting   |       |   | DIN rail (IEC/EN 60715), snap-on mounting without any tool |

# Temperature monitoring relays

## Technical data

**NEW**

Measuring & monitoring relays  
CM Range

| Type  |                                     | CM-TCS.11/12/13  | CM-TCS.21/22/23                             |
|---|-------------------------------------|--|---|
| <b>Electrical connection</b>  |                                     |  |   |
| Wire size   | rigid                               | 2 x 0.5-4 mm <sup>2</sup> (2 x 20-12 AWG)  |   |
|   | fine-strand with wire end ferrule   | 2 x 0.75-2.5 mm <sup>2</sup> (2 x 18-14 AWG)   |   |
| Stripping length  |                                     | 7 mm (0.28 in)   |   |
| Tightening torque   |                                     | 0.6-0.8 Nm (5.31-7.08 lb.in)   |   |
| <b>Electrical connection for devices in new housing</b>   |                                     |  |   |
| Wire size   | rigid                               | Screw connection technology  | Easy Connect Technology (Push-in)           |
|   |                                     | 1 x 0.5-2.5 mm <sup>2</sup> (1 x 20-14 AWG)  | 2 x 0.5-1.5 mm <sup>2</sup> (2 x 20-16 AWG) |
|   |                                     | 2 x 0.5-1.5 mm <sup>2</sup> (2 x 20-16 AWG)  |   |
|   | fine-strand with wire end ferrule   | 1 x 0.5-4 mm <sup>2</sup> (1 x 20-12 AWG)  | 2 x 0.5-1.5 mm <sup>2</sup> (2 x 20-16 AWG) |
|   |                                     | 2 x 0.5-2.5 mm <sup>2</sup> (2 x 20-14 AWG)  |   |
| Stripping length  |                                     | 8 mm (0.32 in)   | 8 mm (0.32 in)                              |
| Tightening torque   |                                     | 0.6-0.8 Nm (5.31-7.08 lb.in)   | -   |
| <b>Standards</b>  |                                     |  |   |
| Product standard  |                                     | IEC/EN 60255-6: 2008   |   |
| Other standards   |                                     | EN 50178, IEC/EN 60204   |   |
| Low Voltage Directive   |                                     | 2006/95/EC   |   |
| EMC Directive   |                                     | 2004/108/EC  |   |
| RoHS Directive  |                                     | 2002/95/EC   |   |
| <b>Environmental data</b>   |                                     |  |   |
| Ambient temperature ranges  | operation/storage/ transport        | -40...+60°C/-40...+85°C/-40...+85°C  |   |
| Climatic category   |                                     | 3K5 (no condensation, no ice formation)  |   |
| Damp heat, cyclic   |                                     | 6 x 24 h cycle, 55 °C, 95 % RH   |   |
| Vibration, sinusoidal   |                                     | Class 2  |   |
| Shock   |                                     | Class 2  |   |
| <b>Isolation data</b>   |                                     |  |   |
| Rated impulse withstand voltage U <sub>imp</sub> between all isolated circuits (IEC/EN 60947-1, IEC/EN 60664-1, VDE 0110-1) | supply circuit / measuring circuit  | 4 kV   | -   |
|   | supply circuit / output circuits    | 4 kV   |   |
|   | measuring circuit / output circuits | 4 kV   |   |
|   | output circuit 1 / output circuit 2 | 4 kV   |   |
| Pollution degree (IEC/EN 60664-1, VDE 0110-1)   |                                     | 3  |   |
| Overvoltage category (IEC/EN 60664-1, VDE 0110-1)   |                                     | III  |   |
| Rated insulation voltage U <sub>i</sub> (IEC/EN 60947-1, IEC/EN 60664-1, VDE 0110-1)  | supply circuit / measuring circuit  | 300 V  | -   |
|   | supply circuit / output circuits    | 300 V  |   |
|   | measuring circuit / output circuits | 300 V  |   |
|   | output circuit 1 / output circuit 2 | 300 V  |   |
| Basis isolation for rated control supply voltage (IEC/EN 60664-1, VDE 0110-1)   | supply circuit / measuring circuit  | 250 V AC / 300 V DC  | -   |
|   | supply circuit / output circuits    | 250 V AC / 300 V DC  |   |
|   | measuring circuit / output circuits | 250 V AC / 300 V DC  |   |
|   | output circuit 1 / output circuit 2 | 250 V AC / 300 V DC  |   |
| Protective separation (IEC/EN 61140, IEC/EN 50178)  | supply circuit / measuring circuit  | 250 V AC / 250 V DC  | -   |
|   | supply circuit / output circuits    | 250 V AC / 300 V DC  | 250 V AC / 250 V DC                         |
|   | measuring circuit / output circuits | 250 V AC / 300 V DC  | 250 V AC / 250 V DC                         |
| Test voltage between all isolated circuits, routine test (IEC/EN 60255-5, IEC/EN 61010-1)                                   | supply circuit / measuring circuit  | 2.0 kV, 50 Hz, 1 s   | -   |
|   | supply circuit / output circuits    | 2.0 kV, 50 Hz, 1 s   |   |
|   | measuring circuit / output circuits | 2.0 kV, 50 Hz, 1 s   |   |
| Test voltage between all isolated circuits, type test (IEC/EN 60255-5)  | supply circuit / measuring circuit  | 4.0 kV, 50 Hz, 1 s   | -   |
|   | supply circuit / output circuits    | 4.0 kV, 50 Hz, 1 s   |   |
|   | measuring circuit / output circuits | 4.0 kV, 50 Hz, 1 s   |   |
| <b>Electromagnetic compatibility</b>  |                                     |  |   |
| Interference immunity to  |                                     | IEC/EN 61000-6-1, IEC/EN 61000-6-2, IEC/EN 61326-2-4                                       |   |
| electrostatic discharge   | IEC/EN 61000-4-2                    | Level 3, 6 kV / 8 kV   |   |
| radiated, radio-frequency, electromagnetic field  | IEC/EN 61000-4-3                    | Level 3, 10 V/m (1 GHz) / 3 V/m (2 GHz) / 1 V/m (2.7 GHz)                                  |   |
| electrical fast transient/burst   | IEC/EN 61000-4-4                    | Level 3, 2 kV / 5 kHz  |   |
| surge   | IEC/EN 61000-4-52                   | Level 3, installation class 3, supply circuit and measuring circuit 1 kV L-L, 2 kV L-earth |   |
| conducted disturbances, induced by radio-frequency fields   | IEC/EN 61000-4-6                    | Level 3, 10 V  |   |
| voltage dips, short interruptions and voltage variations  | IEC/EN 61000-4-11                   | Level 3  |   |
| harmonics and interharmonics  | IEC/EN 61000-4-13                   | Level 3  |   |
| Interference emission   |                                     | EN 61000-6-3, EN 61000-6-4   |   |
| high-frequency radiated   | IEC/CISPR 22, EN 50022              | Class B  |   |
| high-frequency conducted  | IEC/CISPR 22, EN 50022              | Class B  |   |

6

# Temperature monitoring relays

## Technical data

| Type  |                                   | C512   | C513                                     |
|---|-----------------------------------|--|--|
| <b>Input circuit</b>                                  |                                   |  |  |
| Rated control supply voltage                          | $U_s$                             | A1-A2<br>24 V AC/DC  | A1-A2<br>24-240 V AC/DC                  |
| Power consumption                                     |                                   | AC<br>< 7 VA<br>DC<br>< 4 W  |  |
| Rated control supply voltage $U_s$ tolerance          |                                   |  | -15...+10 %                              |
| Rated frequency                                       |                                   | AC   |  |
| <b>Sensor circuit</b>                                 |                                   |  |  |
| Sensor type   |                                   | PT100, PT1000, KTY83, KTY84, NTC   |  |
| Sensor current  |                                   | PT100<br>typ. 1 mA   | PT1000, KTY83, KTY84, NTC<br>typ. 0,2 mA |
| Wire-break detection                                  |                                   | yes (not for NTC)  |  |
| Short-circuit detection                               |                                   | yes  |  |
| 3-wire connection                                     |                                   | yes (2-wire connection of sensors with terminals T2 and T3 bridged)        |  |
| <b>Measuring circuit</b>                              |                                   |  |  |
| Setting accuracy at $T_a = 20\text{ °C}$ ( $T_{20}$ ) |                                   | < $\pm 2\text{ K} \pm 1\text{digit}$                                       |  |
| Accuracy within the temperature range                 |                                   | 0.05 °C / °C deviation from $T_{20}$                                       |  |
| Response time   |                                   | 500 ms   |  |
| Hysteresis settings                                   | temperature 1                     | 1-99 kelvin  |  |
|   | temperature 2                     | 1-99 kelvin  |  |
| Tripping delay  |                                   | 0-999 s  |  |
| <b>Output circuit</b>                                 |                                   |  |  |
| Kind of output  |                                   | 2 c/o + 1n/o   | 2 c/o + 1 n/o                            |
| Rated operating current $I_b$ (IEC/EN 60947-1-5)      | AC12 (resistive) 230 V            | 3 A  |  |
|   | AC15 (inductive) 230 V            | 1 A  |  |
|   | DC12 (resistive) 24 V             | 0,1 A  |  |
|   | DC13 (inductive) 24 V             | 0,1 A  |  |
| Mechanical lifetime                                   |                                   | 30 x 10 <sup>6</sup> switching cycles                                      |  |
| Electrical lifetime (AC15 at 3 A)                     |                                   | 0.1 x 10 <sup>5</sup> switching cycles                                     |  |
| Max. fuse rating to achieve short-circuit protection  |                                   | 4 A, operating class gL/gG   |  |
| <b>General data</b>                                   |                                   |  |  |
| Dimensions (W x H x D)                                |                                   | 45 x 105.9 x 86 mm (1.77 x 4.17 x 3.39 in)                                 |  |
| Tightening torque                                     |                                   | 0.8-1.2 Nm   |  |
| Mounting position                                     |                                   | any  |  |
| Degree of protection                                  | enclosure / terminals             | IP 40 / IP 20  |  |
| Ambient temperature range                             | operation                         | -25...+60 °C   |  |
|   | storage                           | -40...+80 °C   |  |
| Mounting  |                                   | DIN rail (IEC/EN 60715)  |  |
| <b>Electrical connection</b>                          |                                   |  |  |
| Wire size   | rigid                             | 1 x 4 mm <sup>2</sup> (1 x 12 AWG), 2 x 2.5 mm <sup>2</sup> (2 x 14 AWG)   |  |
|   | fine-strand with wire end ferrule | 1 x 2.5 mm <sup>2</sup> (1 x 14 AWG), 2 x 1.5 mm <sup>2</sup> (2 x 16 AWG) |  |
| <b>Standards</b>                                      |                                   |  |  |
| Environmental conditions                              |                                   | IEC 60721-3-3  |  |
| Low Voltage Directive                                 |                                   | IEC 60947-5-1, VDE 0660  |  |
| Electromagnetic compatibility                         | Interference immunity             | EN 61000-6-2   |  |
|   | Interference emission             | EN 61000-6-4   |  |
| Vibration resistance (IEC 68-2-6)                     |                                   | 5-26 Hz / 0.75 mm  |  |
| Shock resistance (IEC 68-2-27)                        |                                   | 15 g / 11 ms   |  |
| <b>Isolation data</b>                                 |                                   |  |  |
| Rated insulation voltage                              |                                   | 300 V AC   |  |
| Pollution degree                                      |                                   | 3  |  |



# CM-E Range Liquid level monitors & controls



Liquid level monitors & controls



## Liquid level monitors and controls

### Benefits and advantages

#### CM-ENE MIN/MAX

- Monitoring of pump systems for dry running (ENE MIN) and overflow (ENE MAX)
- Connection of 2 electrodes possible at C and MIN/MAX
- 3 supply voltage versions
- Optimal price/performance ratio
- 1 n/o contact: Open-circuit principle for CM-ENE MIN, Closed-circuit principle for CM-ENE MAX
- LED for status indication

#### CM-ENS

- 6**
- Monitoring and control of liquid levels (when draining or filling liquids in tanks)
  - Monitoring and control of mixture ratios (conductivity of liquids)
  - Adjustable response sensitivity 5-100 kq
  - 4 supply voltage versions 24 - 415 V AC
  - Version with protective separation acc. to VDE 0160 J
  - Cascadable
  - 1 c/o contact or 1 n/o and 1 n/c contact
  - 2 LEDs for status indication

#### CM-ENS UP/DOWN

- Monitoring and control of liquid levels
- Selectable function "fill" or "drain"
- Adjustable response sensitivity 5-100 kq
- Cascadable
- 1 c/o contact
- 2 LEDs for status indication

#### CM-ENN

- Monitoring and control of liquid levels (when emptying or filling liquids in tanks)
- Monitoring and control of mixture ratios (conductivity of liquids)
- 3 response sensitivities from 250 q - 500 kq in one unit
- 5 supply voltage versions 24 V AC/DC - 415 V AC
- Selectable ON- or OFF-delay 0.1-10 s
- 2 c/o contacts
- 2 LEDs for status indication

#### CM-ENN UP/DOWN

- Liquid level relay with 5 electrode inputs
- Level control with integrated overflow and dry-running protection
- Adjustable response sensitivity 5-100 kq
- Cascadable
- 1 c/o contact and 2 n/c contacts as alarm outputs
- 4 LEDs for status indication

| Response sensitivity        | Max. electrode current | Max. cable capacity | Max. cable length |
|-----------------------------|------------------------|---------------------|-------------------|
| 250 $\Omega$ - 5 k $\Omega$ | 8 mA                   | 200 nF              | 1000 m            |
| 2.5-50 k $\Omega$           | 2 mA                   | 20 nF               | 100 m             |
| 25-500 k $\Omega$           | 0.5 mA                 | 4 nF                | 20 m              |

# Liquid level monitors and controls

## Ordering details

### Description

ABB's liquid level monitoring relays for regulation and control of liquid levels and ratios of mixtures of conductive fluids.

The assortment includes single function and multifunction monitoring relays which can be used for over flow and dry-running protection, for filling and draining applications, for max and min alarm or any combination of such functions. Furthermore, a wide range of accessories is available.

### Ordering details

| Rated control supply voltage | Reference code | Catalog number  | Weight (1 pce) kg (lb) |
|------------------------------|----------------|-----------------|------------------------|
| 24 V AC                      | CM-ENE MIN     | 1SVR550855R9500 | 0.15 (0.33)            |
| 110-130 V AC                 |                | 1SVR550850R9500 | 0.15 (0.33)            |
| 220-240 V AC                 |                | 1SVR550851R9500 | 0.15 (0.33)            |
| 24 V AC                      | CM-ENE MAX     | 1SVR550855R9400 | 0.15 (0.33)            |
| 110-130 V AC                 |                | 1SVR550850R9400 | 0.15 (0.33)            |
| 220-240 V AC                 |                | 1SVR550851R9400 | 0.15 (0.33)            |
| 24 V AC                      | CM-ENS         | 1SVR430851R9100 | 0.15 (0.33)            |
| 110-130 V AC                 |                | 1SVR430851R0100 | 0.15 (0.33)            |
| 220-240 V AC                 |                | 1SVR430851R1100 | 0.15 (0.33)            |
| 380-415 V AC                 |                | 1SVR430851R2100 | 0.15 (0.33)            |
| 220-240 V AC <sup>1)</sup>   |                | 1SVR430851R1300 | 0.15 (0.33)            |
| 24 V AC                      | CM-ENS UP/DOWN | 1SVR430851R9200 | 0.15 (0.33)            |
| 110-130 V AC                 |                | 1SVR430851R0200 | 0.15 (0.33)            |
| 220-240 V AC                 |                | 1SVR430851R1200 | 0.15 (0.33)            |
| 24-240 V AC/DC               | CM-ENN         | 1SVR450055R0000 | 0.30 (0.66)            |
| 24 V AC                      |                | 1SVR450059R0000 | 0.30 (0.66)            |
| 110-130 V AC                 |                | 1SVR450050R0000 | 0.30 (0.66)            |
| 220-240 V AC                 |                | 1SVR450051R0000 | 0.30 (0.66)            |
| 380-415 V AC                 | CM-ENN UP/DOWN | 1SVR450052R0000 | 0.30 (0.66)            |
| 24 V AC                      |                | 1SVR450059R0100 | 0.15 (0.33)            |
| 110-130 V AC                 |                | 1SVR450050R0100 | 0.15 (0.33)            |
| 220-240 V AC                 |                | 1SVR450051R0100 | 0.15 (0.33)            |
| 380-415 V AC                 |                | 1SVR450052R0100 | 0.15 (0.33)            |

<sup>1)</sup> Version with protective separation acc. to VDE 0160, 1 n/o, 1 n/c

### Liquid level monitors are

| Suitable for             | Not suitable for             |
|--------------------------|------------------------------|
| spring water             | chemically pure water        |
| drinking water           | fuel                         |
| sea water                | oils                         |
| sewage                   | explosive areas (liquid gas) |
| acids, bases             | ethylene glycol              |
| liquid fertilizers       | concentrated alcohol         |
| milk, beer, coffee       | paraffin                     |
| non-concentrated alcohol | lacquers                     |



CM-ENE MIN



CM-ENE MAX



CM-ENS



CM-ENN

# Liquid level monitors and controls

## Ordering details

### Accessories

#### Compact support CM-KH-3 for 3 bar electrodes

Dimensions in mm

- Ideally suited for use with liquid level relays CM-ENS and CM-ENN
- Wire connection by screw terminals
- Pull relief by M16 screwed cable glands
- Temperature range up to 90 °C
- Food safe material (PPH)
- Screw-in electrodes (M4 thread)
- Distance plate (CM-AH-3) and locking nut (CM-GM-1) optionally available as an accessory

6

#### Compact support CM-KH-3

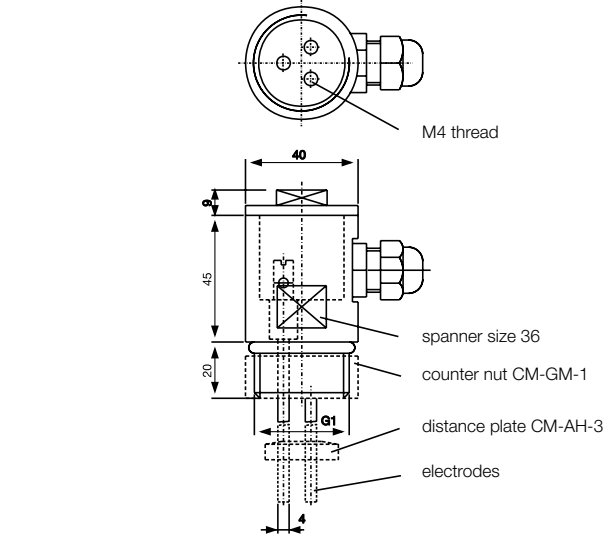
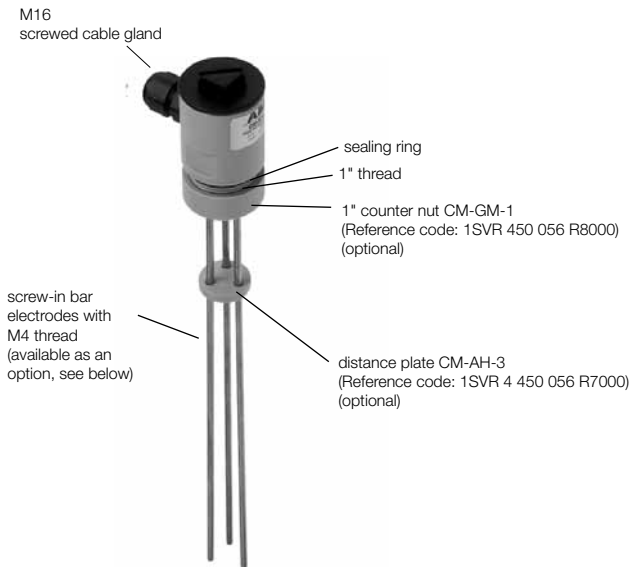

#### Distance plate CM-AH-3

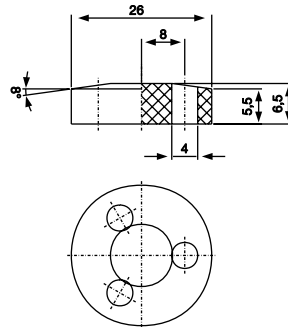

#### Counter nut CM-GM-1

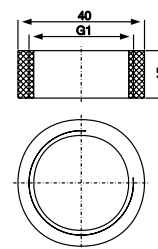

#### Technical data compact support

|                     |                     |
|---------------------|---------------------|
| Type of mounting:   | G 1" thread         |
| Mounting position:  | any                 |
| Enclosure material: | PPH                 |
| Sealing:            | NBR 70              |
| Temperature range:  | 90 °C max.          |
| Pressure:           | 10 bar max. (60 °C) |

| Description                          | Reference code | Catalog number  | Pkg qty | Weight (1 pce) kg (lb) |
|--------------------------------------|----------------|-----------------|---------|------------------------|
| Compact support for 3 bar electrodes | CM-KH-3        | 1SVR450056R6000 |         | 0.06 (0.132)           |
| Distance plate for 3 bar electrodes  | CM-AH-3        | 1SVR450056R7000 | 1       | 0.06 (0.132)           |
| Counter nut for 1" thread            | CM-GM-1        | 1SVR450056R8000 |         | 0.06 (0.132)           |

#### Screw-in bar electrodes for compact support CM-KH-3

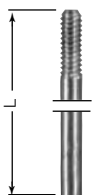

Thread M4

Material: stainless steel 304, high-grade steel 14301

#### Suspension electrode CM-HE



Steel electrode (X14CrMoS17) with sleeve (Lupulen 6011 L) suitable up to 60°C max.

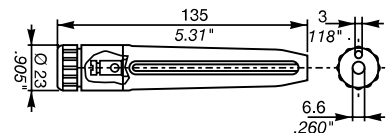

During project engineering the compatibility of the electrode material with the medium to be supervised is to be examined!

| Length  | Reference code | Catalog number  | Pkg qty | Weight (1 pce) kg (lb) |
|---------|----------------|-----------------|---------|------------------------|
| 300 mm  | CM-SE-300      | 1SVR450056R0000 |         | 0.08 (0.176)           |
| 600 mm  | CM-SE-600      | 1SVR450056R0100 | 1       | 0.08 (0.176)           |
| 1000 mm | CM-SE-1000     | 1SVR450056R0200 |         | 0.08 (0.176)           |
| CM-HE   | CM-HE          | 1SVR402902R0000 |         | 0.08 (0.176)           |

# Liquid level monitors and controls

## Function diagrams

Function diagram CM-ENS

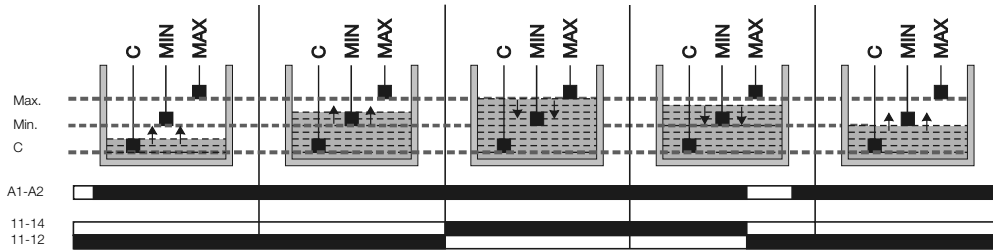

The CM-ENS monitors levels of conductive liquids and is used for example for liquid level control in pump systems. It can be used for filling or draining tanks for example. It is also suitable for monitoring the conductivity of liquids. The measuring principle is based on the resistance change sensed by single-pole electrodes. After the supply voltage is applied to the terminals A1 and A2, the output relay is de-energized. The probes must be connected to C, MAX, MIN. The output relay energizes if the liquid exceeds the maximum level (C and MAX wet) and de-energizes if the liquid level is below the minimum level (MAX and MIN dry). Based on the measuring circuit there will be a response delay of approx. 250 ms at maximum sensitivity. Different levels in one tank can be controlled by up to 5 CM-ENS without interfering with each other.

Function diagram CM-ENN UP/DOWN

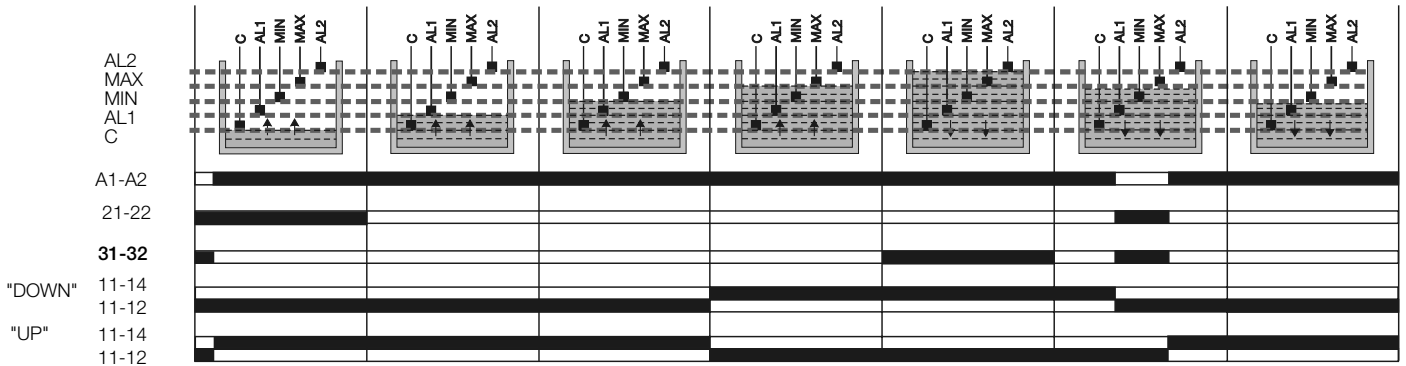

If a metal tank is used, the ground reference electrode C is not required. In this case the cable can be connected directly to the metal surface of the tank.

The CM-ENN UP/DOWN monitors levels of conductive liquids and media and is used e.g. for liquid level control in pump systems. The measuring principle is based on the resistance change sensed by single-pole electrodes. The function of the output relay 11-12/14 can be selected by a selector switch on the front of the unit to fill "UP" or drain "DOWN". If the "UP" function is selected, the output relay is energized until the MAX electrode becomes wet. Then it is de-energized and not re-energized until the MIN electrode becomes dry. If the "DOWN" function is selected, the output relay is energized as soon as the MAX electrode becomes wet. It remains energized until the liquid level has dropped below the MIN electrode. The electrode inputs AL1 and AL2 energize/de-energize the corresponding output relays RAL1 (21-22) and RAL2 (31-32). AL1 opens if contact RAL1 (21-22) is wet. AL2 closes if contact RAL2 (31-32) is wet. This way, two additional alarm outputs for exceeding or dropping below the normal level can be implemented in addition to the filling levels MAX and MIN.

Function diagram CM-ENS UP/DOWN

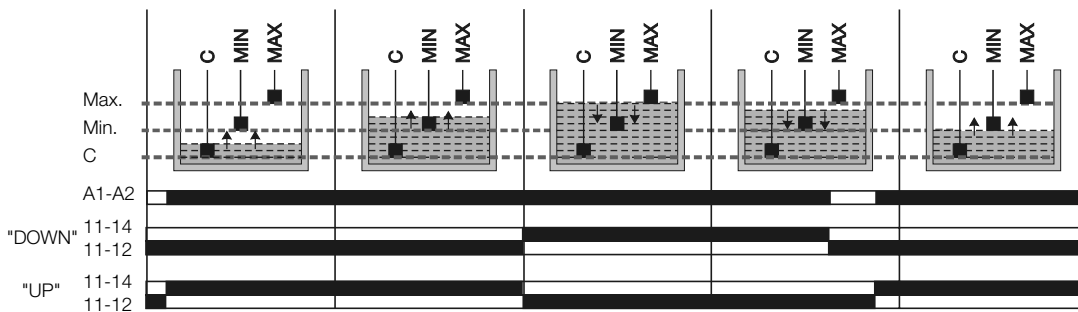

The CM-ENS UP/DOWN monitors levels of conductive liquids and other media, and is used e.g. for liquid level control in pump systems.

The measuring principle is based on the resistance change sensed by single-pole electrodes. The output relay functions fill (UP) or drain (DOWN) can be selected on a front-face selector switch. If the "UP" function is selected, the output relay is energized until the MAX electrode becomes wet. Then it is de-energized and not re-energized until the MIN electrode becomes dry. If the "DOWN" function is selected, the output relay is energized as soon as the MAX electrode becomes wet. It remains energized until the liquid level has dropped below the MIN electrode. The electrodes can be connected to more than one CM-ENS unit without interference.

# Liquid level monitors and controls

## Function diagrams

### Function diagrams CM-ENN

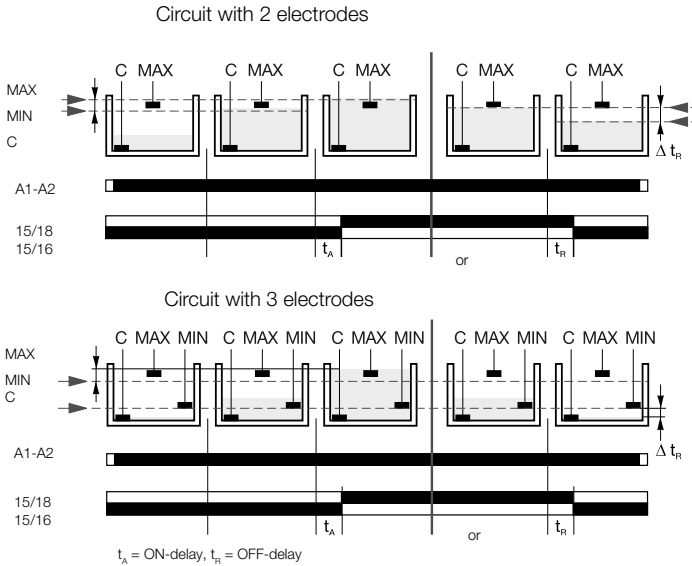

The CM-ENN monitors levels of conductive liquids and is used for example for liquid level monitoring in pump control systems, for dry-running protection of submersible pumps or overflow monitoring of tanks. It is also suitable for conductivity monitoring of liquids. The measuring principle is based on the resistance change sensed by single-pole electrodes (wet or dry).

Instead of electrodes, other sensors or transducers can also be used if their output quantities are different resistance values. The measuring, output and supply circuits are electrically isolated for potential separation and to prevent electrical interference.

Due to the integrated ON- or OFF-delay, it is possible to set up time-dependent liquid controls using only two electrodes (C, MAX). Different liquid levels in one tank can be controlled by up to 5 CM-ENN (AC version) without mutual interference.

### Function diagram CM-ENE MIN

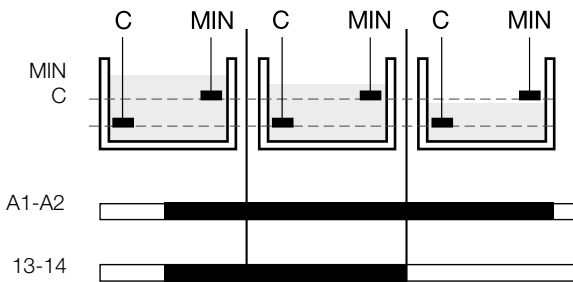

The liquid level relays CM-ENE MIN and CM-ENE MAX are used to monitor levels of conductive liquids, for example in pump control systems for dry-running or overflow monitoring.

The measuring principle is based on the occurring resistance change when moistening single-pole electrodes. The single-pole electrodes (see also section Accessories) are connected to the terminals C and MIN or MAX. If the supply voltage is applied to A1-A2 and the electrodes are wet, the output relay of the CM-ENE MIN is energized and the output relay of the CM-ENE MAX is de-energized.

The output relay of the CM-ENE MIN de-energizes if the electrodes are no longer wet. The output relay of the CM-ENE MAX energizes if the electrodes are no longer wet.

### Function diagram CM-ENE MAX

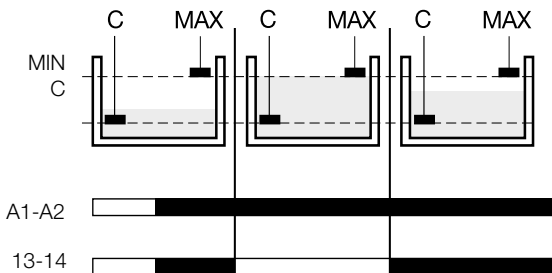

# Liquid level monitors and controls

## Connection diagrams

Connection diagram CM-ENE MIN

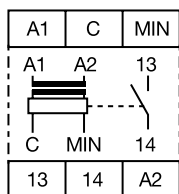

- A1-A2 Rated control supply voltage
- C Ground reference electrode
- MIN Minimum level
- 13-14 Output contact - open-circuit principle

Connection diagram CM-ENE MAX

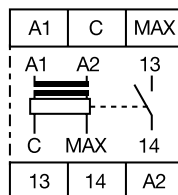

- A1-A2 Rated control supply voltage
- C Ground reference electrode
- MAX Max. level
- 13-14 Output contact - closed-circuit principle

Connection diagram CM-ENS

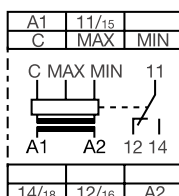

- A1-A2 Rated control supply voltage
- C Ground reference electrode
- MAX Maximum level
- MIN Minimum level
- 11(15)-12(16)/14(18) Output contacts - open-circuit principle

Connection diagram CM-ENN

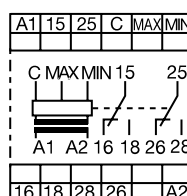

- A1-A2 Rated control supply voltage
- C Ground reference electrode
- MIN Min. level electrode
- MAX Max. level electrode
- 15-16/18 Output contacts - 25-26/28 open-circuit principle

Connection diagram CM-ENS UP/DOWN

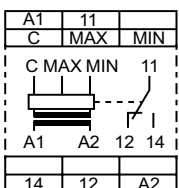

- A1 - A2 Rated control supply voltage
- C Ground reference electrode
- MAX Maximum level
- MIN Minimum level
- 11-12/14 Output contacts - open-circuit or closed-circuit principle selectable

Connection diagram CM-ENN UP/DOWN

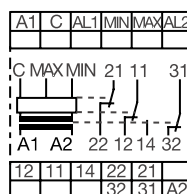

- A1-A2 Rated control supply voltage
- C Ground reference electrode
- MIN Minimum level electrode
- MAX Maximum level electrode
- AL1 Alarm electrode 1
- AL2 Alarm electrode 2
- 11-12/14 Output contacts - open-circuit or closed-circuit principle selectable

# Liquid level monitors and controls

## Application examples

6

### Application examples CM-ENE MIN/MAX

CM-ENE MIN

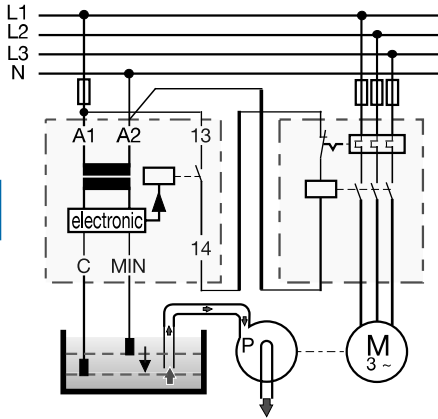

CM-ENE MAX

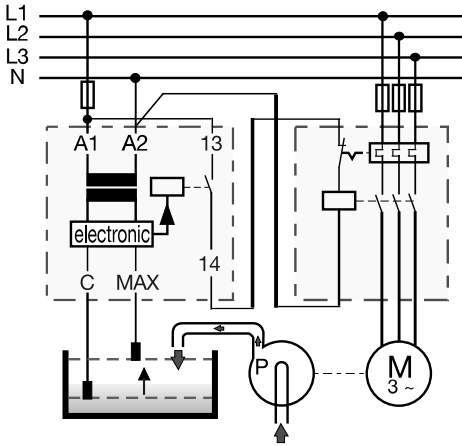

CM-ENE MIN und CM-ENE MAX

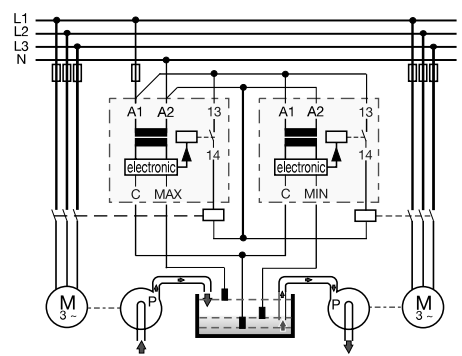

### Application examples CM-ENS

fill

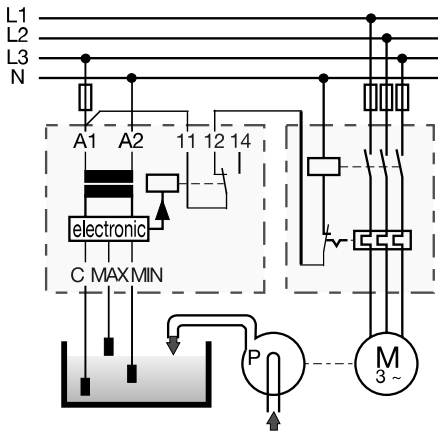

drain

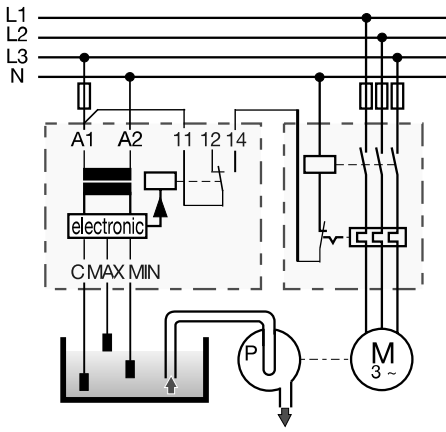

**Cascading**  
The electrode inputs can be interconnected as required, which ensures simple monitoring of different liquid levels.

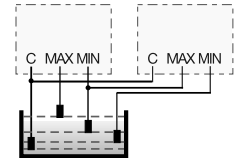

**Redundancy**  
Redundant liquid level monitoring or control can be implemented by connecting the electrodes to two units. This makes the application much safer.

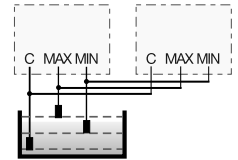

**Cascading of electrodes**  
The electrode inputs can be interconnected as required, which ensures simple monitoring of different liquid levels.

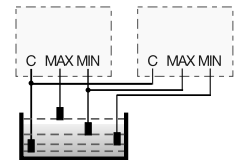

### Application examples CM-ENS UP/DOWN

Liquid level control - fill - switch position "UP"

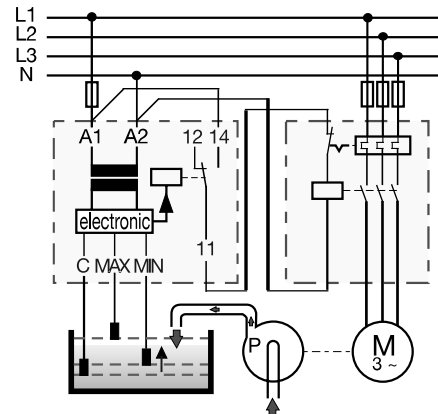

Liquid level control - drain - switch position "DOWN"

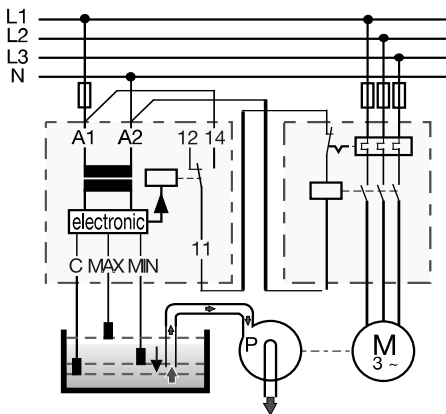

**Redundancy**  
Redundant liquid level monitoring or control can be implemented by connecting the electrodes to two units. This makes the application much safer.

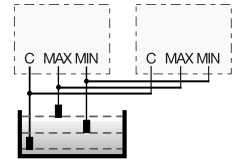



# Liquid level monitors and controls

## Application examples

### Application examples CM-ENN

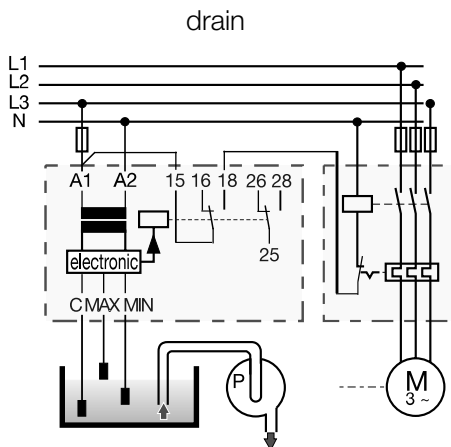
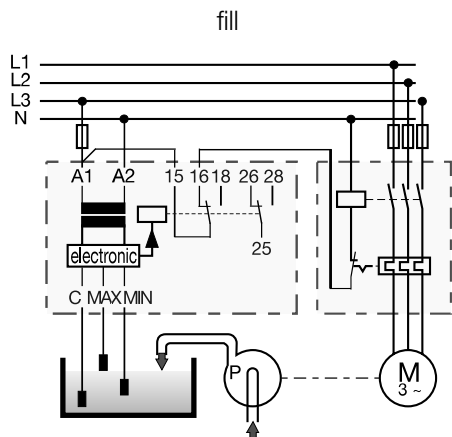

For commissioning, set both potentiometers (response sensitivity = R value and ON-delay = time value) to the minimum value (5) and select a suitable resistance range (sector).

After all electrodes have been wetted by the liquid being monitored, turn the sensitivity potentiometer towards maximum value (100) until the relay energizes. If the relay does not energize, select a higher  $\Omega$  value (sector) on the device and proceed as before.

Then it has to be checked if the relay de-energizes properly as soon as the electrodes C and MIN are no longer wet. Liquid levels higher than the maximum level electrode can be obtained by setting an ON-delay (TA = 0.1...10 s).

Liquid levels lower than the minimum level electrode can be obtained by setting an OFF-delay time (TR = 0.1...10 s), e.g. for emptying tanks.

6

### Application example CM-ENN UP/DOWN

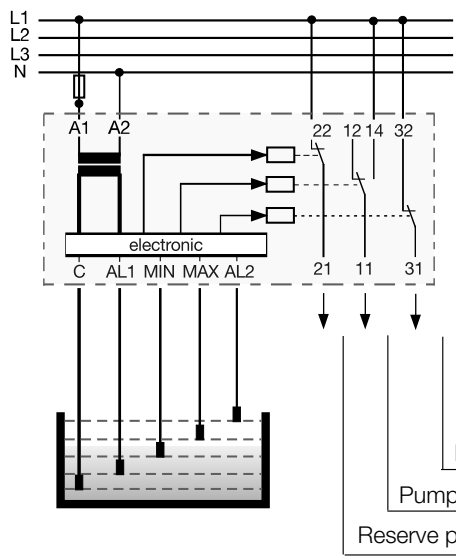

| Electrode              | Relay                        | LED           |
|------------------------|------------------------------|---------------|
| AL1 not wet            | RAL1 (21-22) closed          | off           |
| AL1 wet                | RAL1 (21-22) open            | on            |
| AL2 wet                | RAL2 (31-32) closed          | off           |
| AL2 not wet            | RAL2 (31-32) open            | on            |
| Supply voltage failure | RAL1 (21-22)<br>RAL2 (31-32) | closed<br>off |

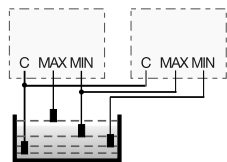

**Cascading of electrodes**  
The electrode inputs can be interconnected as required, which ensures simple monitoring of different liquid levels.

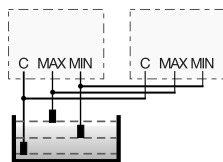

**Redundancy**  
Redundant liquid level monitoring or control can be implemented by connecting the electrodes to two units.

This makes the application much safer.

# Liquid level monitors and controls

## Technical data

6

| Type  |  | CM-ENE MIN                                   | CM-ENE MAX               |
|---|--|--|--------------------------|
| <b>Supply circuit</b>   |  |  |                          |
| Rated control supply voltage $U_s$ - power consumption                            | A1-A2  | 24 V AC                                      | approx. 1.5 VA           |
|   | A1-A2  | 110-130 V AC                                 | approx. 1.2 VA           |
|   | A1-A2  | 220-240 V AC                                 | approx. 1.4 VA           |
| Rated control supply voltage $U_s$ tolerance                                      |  | -15...+15 %                                  |                          |
| Rated frequency   |  | 50-60 Hz                                     |                          |
| Duty time   |  | 100 %  |                          |
| <b>Measuring circuit</b>  |  |  |                          |
| Monitoring function   |  | dry-running protection                       | overflow protection      |
| Response sensitivity  |  | 0-100 k $\Omega$ , not adjustable            |                          |
| Maximum electrode voltage   |  | 30 V AC                                      |                          |
| Maximum electrode current   |  | 1.5 mA                                       |                          |
| Electrode supply line   | max. cable capacity                                | 3 nF   |                          |
|   | max. cable length                                  | 30 m   |                          |
| <b>Timing circuit</b>   |  |  |                          |
| Time delay  |  | -  |                          |
| Tripping delay  |  | fixed approx. 200 ms                         |                          |
| <b>Indication of operational states</b>   |  |  |                          |
| Output relay energized  |  | R: yellow LED                                |                          |
| <b>Output circuits</b>  |  |  |                          |
| Kind of output  |  | 13-14  |                          |
| Operational principle 1)  |  | 1 n/o contact                                |                          |
| Contact material  |  | open-circuit principle                       | closed-circuit principle |
| Rated operational voltage $U_s$ (IEC/EN 60947-1)                                  |  | AgCdo  |                          |
| Minimum switching voltage / minimum switching current                             |  | 250 V  |                          |
| Maximum switching voltage   |  | - / -  |                          |
| Rated operational current $I_s$ (IEC/EN 60947-5-1)                                |  | 250 V  |                          |
| AC rating (UL 508)  | Utilization category (Control Circuit Rating Code) | 4 A  |                          |
|   | max. rated operational voltage                     | 3 A  |                          |
|   | max. continuous thermal current at B 300           | 4 A  |                          |
|   | max. making/breaking apparent power at B 300       | 2 A  |                          |
| Mechanical lifetime   |  | B 300  |                          |
| Electrical lifetime (AC12, 230 V, 4 A)  |  | 300 V AC                                     |                          |
| Max. fuse rating to achieve short-circuit protection                              | n/c contact  | 5 A  |                          |
|   | n/o contact  | 3600/360 VA                                  |                          |
|   |  | 30 x 10 <sup>6</sup> switching cycles        |                          |
|   |  | 0.3 x 10 <sup>6</sup> switching cycles       |                          |
|   |  | -  |                          |
|   |  | 10 A fast-acting                             |                          |
| <b>General data</b>   |  |  |                          |
| Dimensions (W x H x D)  |  | 22.5 x 78 x 78.5 mm (0.89 x 3.07 x 3.09 in)  |                          |
| Mounting position   |  | any  |                          |
| Degree of protection  | enclosure / terminals                              | IP50 / IP20                                  |                          |
| Ambient temperature range   | operation / storage                                | -20...+60 °C / -40...+85 °C                  |                          |
| Mounting  |  | DIN rail (IEC/EN 60715)                      |                          |
| <b>Electrical connection</b>  |  |  |                          |
| Wire size   | fine-strand with wire-end ferrule                  | 2 x 0.75-1.5 mm <sup>2</sup> (2 x 18-16 AWG) |                          |
|   | fine-strand without wire-end ferrule               | 2 x 1-1.5 mm <sup>2</sup> (2 x 18-16 AWG)    |                          |
|   | rigid  | 2 x 0.75-1.5 mm <sup>2</sup> (2 x 18-16 AWG) |                          |
| Stripping length  |  | 10 mm (0.39 inch)                            |                          |
| Tightening torque   |  | 0.6-0.8 Nm                                   |                          |
| <b>Standards</b>  |  |  |                          |
| Product standard  |  | IEC 255-6, EN 60255-6                        |                          |
| Low Voltage Directive   |  | 2006/95/EC                                   |                          |
| EMC Directive   |  | 2004/108/EC                                  |                          |
| <b>Electromagnetic compatibility</b>  |  |  |                          |
| electrostatic discharge   | IEC/EN 61000-4-2                                   | EN 61000-6-2, EN 61000-6-4                   |                          |
| radiated, radio-frequency, electromagnetic field                                  | IEC/EN 61000-4-3                                   | Level 3 (6 kV / 8 kV)                        |                          |
| electrical fast transient / burst   | IEC/EN 61000-4-4                                   | Level 3 (10 V/m)                             |                          |
| surge   | IEC/EN 61000-4-5                                   | Level 3 (2 kV / 5 kHz)                       |                          |
| conducted disturbances, induced by radio-frequency fields                         | IEC/EN 61000-4-6                                   | Level 4 (2 kV L-L)                           |                          |
| Resistance to vibration (IEC 68-2-6)  |  | Level 3 (10 V)                               |                          |
| Mechanical resistance (IEC 68-2-6)  |  | 6 g  |                          |
|   |  | 10 g   |                          |
| <b>Isolation data</b>   |  |  |                          |
| Rat. insulation volt. betw. supply, meas. & output circuit (VDE 0110, IEC 60947)  |  | 250 V  |                          |
| Rated impulse withstand voltage between all isolated circuits (VDE 0110, IEC 664) |  | 4 kV / 1.2-50 $\mu$ s                        |                          |
| Test voltage between all isolated circuits  |  | 2.5 kV, 50 Hz, 1 min.                        |                          |
| Pollution category (VDE 0110, IEC 664, IEC 255-5)                                 |  | 3 / C  |                          |
| Overvoltage category (VDE 0110, IEC 664, IEC 255-5)                               |  | III / C                                      |                          |
| Environmental testing (IEC 68-2-30)   |  | 24 h cycle time, 55 °C, 93 % rel., 96 h      |                          |

1) Open-circuit principle: Output relay energizes if the measured value exceeds/drops below the adjusted threshold.  
Closed-circuit principle: Output relay de-energizes if the measured value exceeds/drops below the adjusted threshold.

# Liquid level monitors and controls

## Technical data

Measuring &  
monitoring relays  
CM Range

6

| Type  |  | CM-ENS                      | CM ENS UP/DOWN                             |
|---|--|-----------------------------|--|
| <b>Supply circuit</b>   |  |                             |  |
| Rated control supply voltage $U_s$ - power consumption                                      | A1-A2  | 24 V AC                     | 24 V AC                                    |
|   | A1-A2  | 110-130 V AC approx. 1.5 VA | 110-130 V AC approx. 4 VA                  |
|   | A1-A2  | 220-240 V AC approx. 1.5 VA | 220-240 V AC approx. 4 VA                  |
|   | A1-A2  | 380-415 V AC approx. 1.5 VA |  |
| Rated control supply voltage $U_s$ tolerance  |  |                             | -15...+10 %                                |
| Rated frequency   |  |                             | 50-60 Hz                                   |
| Duty time   |  |                             | 100 %                                      |
| <b>Measuring circuit</b>  |  |                             |  |
| Monitoring function   |  |                             | MAX-MIN-C                                  |
| Response sensitivity  |  |                             | liquid level control                       |
| Maximum electrode voltage   |  |                             | 5-100 kg, adjustable                       |
| Maximum electrode current   |  |                             | 30 V AC                                    |
| Electrode supply line   | max. cable capacity                                |                             | 1 mA                                       |
|   | max. cable length                                  |                             | 10 nF                                      |
|   |  |                             | 100 m                                      |
| <b>Timing circuit</b>   |  |                             |  |
| Time delay  |  |                             | -  |
| Tripping delay  |  |                             | approx. 250 ms                             |
| <b>Indication of operational states</b>   |  |                             |  |
| Control supply voltage  |  |                             | U: green LED                               |
| Output relay energized  |  |                             | R MAX/MIN: yellow LED                      |
| Alarm relay AL1   |  |                             | R AL1: yellow LED                          |
| Alarm relay AL2   |  |                             | R AL2: yellow LED                          |
| <b>Output circuits</b>  |  |                             |  |
| Kind of output  |  |                             | 11-12/14, 21-22, 31-32                     |
| Operational principle <sup>1)</sup>   |  |                             | 1 c/o contact, 1 n/o + 1 n/c contact 2)    |
| Contact material  |  |                             | open-circuit principle                     |
| Rated operational voltage $U_o$ (IEC/EN 60947-1)  |  |                             | open- and closed-circuit principle         |
| Minimum switching voltage / minimum switching current                                       |  |                             | AgCdo                                      |
| Maximum switching voltage   |  |                             | 250 V                                      |
| Rated operational current $I_o$ (IEC/EN 60947-5-1)  |  |                             | - / -                                      |
|   | AC12 (resistive) 230 V                             |                             | 250 V                                      |
|   | AC15 (inductive) 230 V                             |                             | 4 A  |
|   | DC12 (resistive) 24 V                              |                             | 3 A  |
|   | DC13 (inductive) 24 V                              |                             | 4 A  |
|   |  |                             | 2 A  |
| AC rating (UL 508)  | Utilization category (Control Circuit Rating Code) |                             | B 300                                      |
|   | max. rated operational voltage                     |                             | 300 V AC                                   |
|   | max. continuous thermal current at B 300           |                             | 5 A  |
|   | max. making/breaking apparent power at B 300       |                             | 3600/360 VA                                |
| Mechanical lifetime   |  |                             | 30 x 10 <sup>6</sup> switching cycles      |
| Electrical lifetime (AC12, 230 V, 4 A)  |  |                             | 0.3 x 10 <sup>6</sup> switching cycles     |
| Max. fuse rating to achieve short-circuit protection  | n/c / n/o contact                                  |                             | 10 A fast-acting / 10 A fast-acting        |
| <b>General data</b>   |  |                             |  |
| Dimensions (W x H x D)  |  |                             | 22.5 x 70 x 100 mm (0.89 x 3.07 x 3.94 in) |
| Mounting position   |  |                             | any  |
| Degree of protection  | enclosure / terminals                              |                             | IP50 / IP20                                |
| Ambient temperature range   | operation / storage                                |                             | -20...+60 °C / -40...+85 °C                |
| Mounting  |  |                             | DIN rail (IEC/EN 60715)                    |
| <b>Electrical connection</b>  |  |                             |  |
| Wire size   | fine-strand with wire end ferrule                  |                             | 2 x 2.5 mm <sup>2</sup> (2 x 14 AWG)       |
| Standards   |  |                             |  |
| Product standard  |  |                             | IEC 255-6, EN 60255-6                      |
| Low Voltage Directive   |  |                             | 2006/95/EG                                 |
| EMC Directive   |  |                             | 2004/108/EG                                |
| <b>Electromagnetic compatibility</b>  |  |                             |  |
| electrostatic discharge   | IEC/EN 61000-4-2                                   |                             | Level 3 (6 kV / 8kV)                       |
| radiated, radio-frequency, electromagnetic field  | IEC/EN 61000-4-3                                   |                             | Level 3 (10 V/m)                           |
| electrical fast transient / burst   | IEC/EN 61000-4-4                                   |                             | Level 3 (2 kV / 5 kHz)                     |
| surge   | IEC/EN 61000-4-5                                   |                             | Level 4 (2 kV L-L)                         |
| conducted disturbances, induced by radio-frequency fields                                   | IEC/EN 61000-4-6                                   |                             | Level 3 (10 V)                             |
| Resistance to vibration (IEC 68-2-6)  |  |                             | 4 g  |
| Mechanical resistance (IEC 68-2-6)  |  |                             | 6 g  |
| <b>Isolation data</b>   |  |                             |  |
| Rated insulation voltage between supply, measuring and output circuit (VDE 0110, IEC 60947) |  |                             | 250 V                                      |
| Rated impulse withstand voltage between all isolated circuits (VDE 0110, IEC 664)           |  |                             | 4 kV / 1.2 - 50 μs                         |
| Test voltage between all isolated circuits  |  |                             | 2.5 kV, 50 Hz, 1 min.                      |
| Pollution category (VDE 0110, IEC 664, IEC 255-5)   |  |                             | 3 / C                                      |
| Overvoltage category (VDE 0110, IEC 664, IEC 255-5)   |  |                             | III / C                                    |
| Environmental testing (IEC 68-2-30)   |  |                             | 24 h cycle time, 55 °C, 93 % rel., 96 h    |

<sup>1)</sup> Open-circuit principle: Output relay energizes if the measured value exceeds/drops below the adjusted threshold.  
 Closed-circuit principle: Output relay de-energizes if the measured value exceeds/drops below the adjusted threshold.

<sup>2)</sup> 1SVR 430 851 R1300 (version with safe isolation)

# Liquid level monitors and controls

## Technical data

6

| Type   |  | CM-ENN UP/DOWN                           |                             | CM-ENN  |
|--|--|--|-----------------------------|---|
| <b>Supply circuit</b>  |  |  |                             |   |
| Rated control supply voltage $U_s$ - power consumption   | A1-A2  | 24 V AC                                  |                             | 24 V AC   |
|  | A1-A2  | 110-130 V AC approx. 1.5 VA              |                             | 110-130 V AC approx. 2.5 VA   |
|  | A1-A2  | 220-240 V AC approx. 1.5 VA              |                             | 220-240 V AC approx. 3 VA   |
|  | A1-A2  | 380-415 V AC approx. 1.5 VA              |                             | 380-415 V AC approx. 4 VA   |
|  | A1-A2  |  |                             | 24-240 V AC/DC approx. 2 VA/W   |
| Rated control supply voltage $U_s$ tolerance   |  |  |                             | -15...+10 %   |
| Rated frequency  |  | 50-60 Hz                                 |                             | 50-60 Hz oder DC  |
| Duty time  |  |  |                             | 100 %   |
| <b>Measuring circuit</b>   |  |  |                             |   |
| Monitoring function  |  | MAX-MIN-C<br>liquid level control        |                             |   |
| Response sensitivity   |  | adjustable<br>5-100 k $\Omega$           | 250 $\Omega$ - 5 k $\Omega$ | adjustable<br>2.5-50 k $\Omega$   25-500 k $\Omega$                             |
| Maximum electrode voltage  |  | 30 V AC                                  |                             | 20 V AC   |
| Maximum electrode current  |  | 1 mA                                     | 8 mA                        | 2 mA   0.5 mA   |
| Electrode supply line  | max. cable capacity                                | 10 nF                                    | 200 nF                      | 20 nF   4 nF  |
|  | max. cable length                                  | 100 m                                    | 1000 m                      | 100 m   20 m  |
| <b>Timing circuit</b>  |  |  |                             |   |
| Time delay   |  | -  |                             | 0.1-10 s, adjustable, ON- or OFF-delay  |
| Tripping delay   |  | approx. 250 ms                           |                             | -   |
| <b>Indication of operational states</b>  |  |  |                             |   |
| Control supply voltage   |  | U: green LED                             |                             |   |
| Output relay energized   |  | R MAX/MIN: yellow LED                    |                             | R: yellow LED   |
| <b>Output circuits</b>   |  |  |                             |   |
| Kind of output   |  | 11-12/14, 21-22, 31-32                   |                             | 15-16/18, 25-26/28  |
| Operational principle <sup>1)</sup>  |  | 1 c/o + 2 n/c contacts                   |                             | 2 c/o contacts  |
| Contact material   |  | open-circuit principle                   |                             | open- and closed-circuit principle  |
| Rated operational voltage $U_e$  | IEC/EN 60947-1                                     | 250 V                                    |                             | 400 V   |
| Minimum switching voltage / minimum switching current  |  | - / -                                    |                             | - / -   |
| Maximum switching voltage  |  | 250 V                                    |                             | 400 V   |
| Rated operational current $I_e$<br>(IEC/EN 60947-5-1)  | AC12 (resistive) 230 V                             | 4 A                                      |                             | 5 A   |
|  | AC15 (inductive) 230 V                             |  | 3 A                         |   |
|  | DC12 (resistive) 24 V                              | 4 A                                      |                             | 5 A   |
|  | DC13 (inductive) 24 V                              | 2 A                                      |                             | 2.5 A   |
| AC rating (UL 508)   | Utilization category (Control Circuit Rating Code) |  |                             | B 300   |
|  | max. rated operational voltage                     |  |                             | 300 V AC  |
|  | max. continuous thermal current at B 300           |  |                             | 5 A   |
|  | max. making/breaking apparent power at B 300       |  |                             | 3600/360 VA   |
| Mechanical lifetime  |  |  |                             | 30 x 10 <sup>5</sup> switching cycles   |
| Electrical lifetime (AC12, 230 V, 4 A)   |  |  |                             | 0.3 x 10 <sup>6</sup> switching cycles   0.1 x 10 <sup>6</sup> switching cycles |
| Max. fuse rating to achieve short-circuit protection   | n/c / n/o contact                                  |  |                             | 4 A fast-acting / 6 A fast-acting   |
| <b>General data</b>  |  |  |                             |   |
| Dimensions (W X H X D)   |  | 45 x 78 x 100 mm (1.77 x 3.07 x 3.94 in) |                             |   |
| Mounting position  |  | any                                      |                             |   |
| Degree of protection   | enclosure / terminals                              | IP50 / IP20                              |                             |   |
| Ambient temperature range  | operation / storage                                | -25...+65 °C / -40...+85 °C              |                             |   |
| Mounting   |  | DIN rail (IEC/EN 60715)                  |                             |   |
| <b>Electrical connection</b>   |  |  |                             |   |
| Wire size  | fine-strand with wire end ferrule                  | 2 x 2.5 mm <sup>2</sup> (2 x 14 AWG)     |                             |   |
| <b>Standards</b>   |  |  |                             |   |
| Product standard   |  | IEC 255-6, EN 60255-6                    |                             |   |
| Low Voltage Directive  |  | 2006/95/EG                               |                             |   |
| EMC Directive  |  | 2004/108/EG                              |                             |   |
| <b>Electromagnetic compatibility</b>   |  |  |                             |   |
| electrostatic discharge  | IEC/EN 61000-4-2                                   | Level 3 (6 kV / 8kV)                     |                             |   |
| radiated, radio-frequency, electromagnetic field   | IEC/EN 61000-4-3                                   | Level 3 (10 V/m)                         |                             |   |
| electrical fast transient / burst  | IEC/EN 61000-4-4                                   | Level 3 (2 kV / 5 kHz)                   |                             |   |
| surge  | IEC/EN 61000-4-5                                   | Level 4 (2 kV L-L)                       |                             |   |
| conducted disturbances, induced by radio-frequency fields                                      | IEC/EN 61000-4-6                                   | Level 3 (10 V)                           |                             |   |
| Resistance to vibration (IEC 68-2-6)   |  | 5 g                                      |                             |   |
| Mechanical resistance (IEC 68-2-6)   |  | 10 g                                     |                             |   |
| <b>Isolation data</b>  |  |  |                             |   |
| Rated insulation voltage between supply, measuring and output circuit<br>(VDE 0110, IEC 60947) |  | 250 V                                    |                             | 500 V   |
| Rated impulse withstand voltage between all isolated circuits (VDE 0110, IEC 664)              |  |  |                             | 4 kV / 1.2 - 50 $\mu$ s   |
| Test voltage between all isolated circuits   |  |  |                             | 2.5 kV, 50 Hz, 1 min.   |
| Pollution category (VDE 0110, IEC 664, IEC 255-5)  |  |  |                             | 3 / C   |
| Overvoltage category (VDE 0110, IEC 664, IEC 255-5)  |  |  |                             | III / C   |
| Environmental testing (IEC 68-2-30)  |  | 24 h cycle time, 55 °C, 93 % rel., 96 h  |                             |   |

<sup>1)</sup> Open-circuit principle: Output relay energizes if the measured value exceeds/drops below the adjusted threshold.  
Closed-circuit principle: Output relay de-energizes if the measured value exceeds/drops below the adjusted threshold.

# Contact protection & sensor interface relays



Contact protection & sensor interface relays



## Contact protection and sensor interface relays

### Ordering details

#### Description

##### Contact protection relay:

The CM-KRN protects sensitive control contacts from excessive load. It can be used with latching function or without. Bounce time of control contacts can be bypassed by the adjustable response delay time. Use for contact protection.

##### Contact protection relay:

The CM-SIS is used to supply 2- or 3-wire NPN or PNP sensors with power and to evaluate their switching signals. Two sensors of the types NPN or PNP can be connected simultaneously. Selection is done via the front-face rotary switch.



CM-KRN



CM-SIS

#### Ordering details

| Rated control supply voltage              | Timing circuit | Reference code | Catalog number  | Weight (1 pce)<br>kg (lb) |
|---|----------------|----------------|-----------------|---------------------------|
| 24 V AC                                   | 0.05-30 s      | CM-KRN         | 1SVR450089R0000 | 0.30 (0.66)               |
| 110-130 V AC                              |                |                | 1SVR450080R0000 | 0.30 (0.66)               |
| 220-240 V AC                              |                |                | 1SVR450081R0000 | 0.30 (0.66)               |
| 380-415 V AC                              |                |                | 1SVR450082R0000 | 0.30 (0.66)               |
| 24 V AC                                   |                |                | 1SVR450099R0000 | 0.30 (0.66)               |
| 110-130 V AC                              |                |                | 1SVR450090R0000 | 0.30 (0.66)               |
| 220-240 V AC                              |                |                | 1SVR450091R0000 | 0.30 (0.66)               |
| 24 V AC/DC <sup>1)</sup>                  |                |                | 1SVR450099R1000 | 0.30 (0.66)               |
| 110-240 V AC / 105-260 V DC <sup>2)</sup> |                | CM-SIS         | 1SVR430500R2300 | 0.22 (0.48)               |

<sup>1)</sup> Not electrically isolated

<sup>2)</sup> Safe isolation, short circuit and overload proof

#### Characteristics CM-KRN

- Protects and reduces load from sensitive control contacts
- Adjustable ON-delay 0.05-30 s
- Acts as two-position switch
- Stores switch positions
- Electrically isolated circuits
- 2 c/o contacts
- 2 LEDs for status indication

#### Characteristics CM-SIS

- High efficiency
- Low heating
- Wide range of supply voltage
- Constant output voltage 24 V DC
- Safe isolation acc. to EN 50178 (VDE 0160)
- Short-circuit and overload proof
- Input protected by internal fuse
- 2 x 1 c/o contact
- 3 LEDs for status indication

# Contact protection and sensor interface relays

## Technical information

Use for contact protection. The contact to be protected is connected to terminals Y1 and Y2. Use for contact protection with latching capacity. The output relay energizes after contact Y1-Y3 has been closed for at least 20 ms. It remains energized until contact Y1-Y4 closes. The switching positions are stored. The relay is suitable for load reduction purposes for devices with minimum and maximum contacts. The CM-KRN can be operated via 3-wire proximity sensors for switching of higher power. The supply circuit, the control circuit and the output circuit are electrically isolated against each other.

### Function diagram CM-KRN

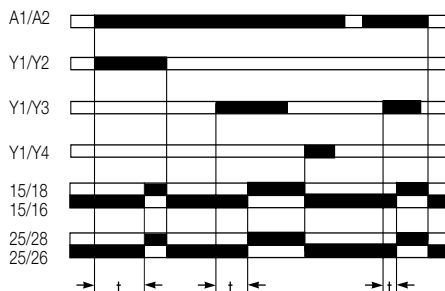

### Connection diagram CM-KRN

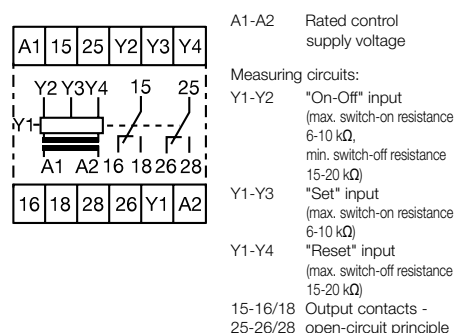

### Use, applications

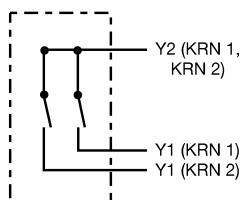

Actuators with 2 contacts and one common point can be connected to 2 separate CM-KRN units. Connect the common point of contacts to terminals Y2 of the two CM-KRN units.

### Operation via 3-wire proximity sensors NPN

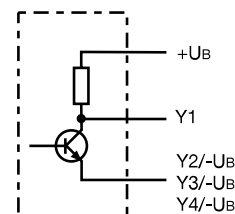

On; relay energizes, Y1/Y3 or Y2  
Off; relay de-energizes, Y1/Y4 or Y2

The CM-SIS (terminals L+, L-) supplies the connected sensors with voltage (24 V DC), the maximum power supply current is 0.5 A. The supply voltage and the sensor inputs are electrically isolated from the supply circuit. To ensure maximum safety when using these sensors, the principle of safe isolation has been included.

### Function diagram CM-SIS

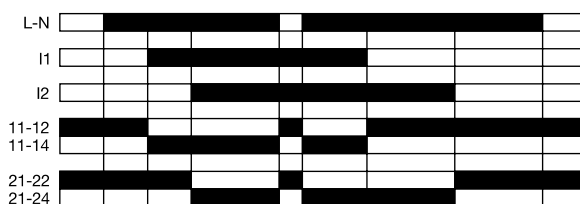

### Connection diagram CM-SIS

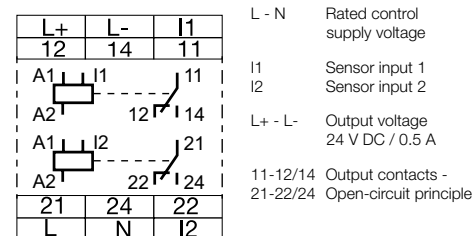

Each sensor input signal energizes the corresponding output relay without delay. The relay is energized as soon as a threshold current is exceeded at input I1 or I2. Sensor leakage currents of up to 8 mA don't affect the evaluation. The threshold value is about 9 mA. If the threshold value at input I1 or I2 is exceeded the corresponding relay R1 or R2 energizes and the corresponding LED lights up.

### Connection of 2-wire sensors

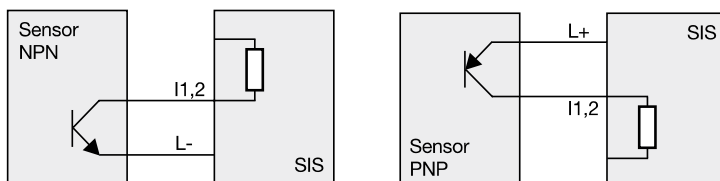

The wide-range supply voltage input of CM-SIS allows its application in nearly all supply systems.

### Connection of 3-wire sensors

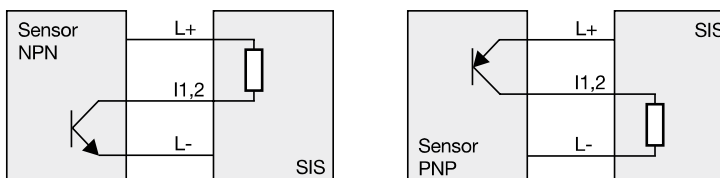



The CM-SIS is also suitable for other applications, for example it is also possible to connect PTC or NTC resistors instead of PNP or NPN sensors or to operate the SIS directly by switching contacts.

# Contact protection and sensor interface relays

## Technical data

6

|   |  |  |
|---|--|--|
| <b>Type</b>   |  | CM-KRN   |
| <b>Supply circuit</b>                                     |  | A1-A2  |
| Rated control supply voltage $U_s$ - power consumption    | A1-A2  | 24 V AC - approx. 3.5 VA   |
|   | A1-A2  | 24 V AC/DC - approx. 3.5 VA  |
|   | A1-A2  | 110-130 V AC - approx. 3.5 VA  |
|   | A1-A2  | 220-240 V AC - approx. 3.5 VA  |
|   | A1-A2  | 380-415 V AC - approx. 3.5 VA  |
| Rated control supply voltage $U_s$ tolerance              |  | -15...+10 %  |
| Rated frequency   |  | 50-60 Hz   |
| Duty time   |  | 100 %  |
| <b>Timing circuit</b>                                     |  |  |
| ON-delay time   |  | 0.05-1 s, 1.5-30 s   |
| OFF-delay time  |  | max. 50 ms   |
| <b>Measuring circuit / contact circuit</b>                |  | Y1-Y2/Y3/Y4  |
| Measuring input   | contact protection without latching                | Y1-Y2  |
|   | contact protection with latching                   | Y1-Y3/Y4   |
| Threshold   | Y1-Y2/Y3   | 6-10 k $\Omega$  |
| Threshold-Hysteresis                                      | Y1-Y2/Y4   | 15-20 k $\Omega$   |
| No-load voltage at the measuring input                    |  | $\leq$ 10 V DC   |
| Contact time for latching (CM-KRN without timing circuit) |  | min. 20 ms   |
| Switching current at the measuring input                  |  | 3 mA   |
| Maximum applied voltage at the measuring input            |  | $\leq$ $\pm$ 30 V (contact voltage)  |
| <b>Indication of operational states</b>                   |  |  |
| Control supply voltage                                    | U: green LED                                       |  : control supply voltage applied |
| Relay status  | R: yellow LED                                      |  : output relay energized        |
| Output circuit  |  | 15-16/18, 25-26/28   |
| Kind of output  |  | relay, 2 c/o contacts  |
| Operating principle <sup>1)</sup>                         |  | open-circuit principle   |
| Rated operational voltage (VDE 0110, IEC 60947-5-1)       |  | 400 V  |
| Rated switching voltage                                   |  | 400 V AC   |
| Rated operational current $I_n$ (IEC/EN 60947-5-1)        | AC12 (resistive) 230 V                             | 5 A  |
|   | AC15 (inductive) 230 V                             | 3 A  |
|   | DC12 (resistive) 24 V                              | 5 A  |
|   | DC13 (inductive) 24 V                              | 2.5 A  |
| AC rating (UL 508)  | Utilization category (Control Circuit Rating Code) | B 300  |
|   | max. rated operational voltage                     | 300 V AC   |
|   | max. continuous thermal current at B 300           | 5 A  |
|   | max. making/breaking apparent power at B 300       | 3600/360 VA  |
| Mechanical lifetime                                       |  | 30 x 10 <sup>6</sup> switching cycles  |
| Electrical lifetime (AC12, 230 V, 5 A)                    |  | 0.1 x 10 <sup>6</sup> switching cycles   |
| Max. fuse rating to achieve short-circuit protection      | n/c / n/o contact                                  | 10 A fast-acting / 10 A fast-acting  |
| <b>General data</b>                                       |  |  |
| Dimensions (W x H x D)                                    |  | 45 x 78 x 100 mm (1.77 x 3.07 x 3.94 in)   |
| Mounting position   |  | any  |
| Degree of protection                                      | enclosure / terminals                              | IP20 / IP50  |
| Ambient temperature range                                 | operation / storage                                | -25...+65 °C / -40...+85 °C  |
| Mounting  |  | DIN rail (IEC/EN 60715)  |
| <b>Electrical connection</b>                              |  |  |
| Wire size   | fine-strand with wire end ferrule                  | 2 x 2.5 mm <sup>2</sup> (2 x 14 AWG)   |
| <b>Standards</b>  |  |  |
| Product standard  |  | IEC 255-6, EN 60255-6  |
| Low Voltage Directive                                     |  | 2006/95/EC   |
| EMC Directive   |  | 2004/108/EC  |
| <b>Electromagnetic compatibility</b>                      |  |  |
| Interference immunity to                                  |  |  |
| electrostatic discharge                                   | IEC/EN 61000-4-2                                   | 6 kV / 8 kV  |
| radiated, radio-frequency, electromagnetic field          | IEC/EN 61000-4-3                                   | 10 V/m   |
| electrical fast transient / burst                         | IEC/EN 61000-4-4                                   | 2 kV / 5 kHz   |
| surge   | IEC/EN 61000-4-5                                   | 2 kV symmetrical   |
| conducted disturbances, induced by radio-frequency fields | IEC/EN 61000-4-6                                   | 10 V   |
| <b>Isolation data</b>                                     |  |  |
| Rated insulation voltage (IEC 60947-1)                    |  | 400 V  |
| Rated impulse withstand voltage $U_{imp}$ (IEC 644-6)     |  | 4 kV   |
| Pollution category (IEC 255-5, IEC 664)                   |  | 3  |
| Overvoltage category (IEC 255-5, IEC 664)                 |  | III  |

<sup>1)</sup> Open-circuit principle: Output relay is energized if the measured value exceeds/drops below the adjusted threshold.



# Contact protection and sensor interface relays

## Technical information

Measuring & monitoring relays  
CM Range

6

| Type   |  | CM-SIS  |
|--|--|---|
| <b>Input circuit</b>   |  |   |
| Supply voltage   | L-N AC<br>DC   | 110-240 V AC (-15...+10 %)<br>110-240 V (max. 105-260 V DC)         |
| Frequency, AC supply   |  | 47-440 Hz   |
| Supply voltage failure bridging time                           |  | 10 ms min. at 100 % load  |
| Current consumption  | max.<br>at 115 V AC<br>at 230 V AC   | 0.35 A<br>0.27 A<br>0.14 A  |
| Inrush current at 25°C (≤ 2 ms)                                |  | 33 A  |
| Internal input fuse  |  | 800 mA slow-acting  |
| <b>Measuring circuit</b>                                       |  |   |
| Sensor voltage   | L+ L-  | 24 V DC ± 3%  |
| Sensor current / power   |  | max. 0.5 A / 12 W   |
| Residual ripple  |  | max. 100 mV <sub>pp</sub>   |
| Deviation with   | load change statical<br>load change dynamical 10-90 %<br>change of the input voltage   | max. ± 0.5 %<br>max. .5 %<br>max. ± 0.5 %                           |
| Short-circuit protection                                       |  | overcurrent switch-off with automatic restart                       |
| Overload protection  |  | excess temperature and overcurrent switch-off                       |
| Reset after thermal overload switch-off                        |  | automatic reset after cooling down                                  |
| Sensor type connection possibilities                           | I1, I2   | 2- or 3-wire connection, NPN or PNP selectable by front-face switch |
| Input resistance   |  | approx. 2.5 kΩ  |
| Threshold value for relays R1, R2                              |  | $U_{emitter/collector} < 2.3 \text{ V (I1, I2 > 8 mA)}$             |
| Maximum switching frequency                                    |  | approx. 20 Hz   |
| <b>Output circuit</b>  |  |   |
| Kind of output   |  | 11-12/14, 21-22/24<br>2 relays, 1 c/o contact each                  |
| Operating principle <sup>1)</sup>                              |  | open-circuit principle  |
| Rated operational voltage                                      |  | 250 V   |
| Maximum switching voltage                                      |  | 250 V AC  |
| Rated operational current I <sub>n</sub><br>(IEC/EN 60947-5-1) | AC12 (resistive) 230 V<br>AC15 (inductive) 230 V<br>DC12 (resistive) 24 V<br>DC13 (inductive) 24 V   | 4 A<br>3 A<br>4 A<br>2 A  |
| AC rating (UL 508)   | Utilization category (Control Circuit Rating Code)<br>max. rated operational voltage<br>max. continuous thermal current at B 300<br>max. making/breaking apparent power at B 300 | B 300<br>300 V AC<br>5 A<br>3600/360 VA                             |
| Mechanical lifetime  |  | 10 x 10 <sup>6</sup> switching cycles                               |
| Electrical lifetime  |  | 0.1 x 10 <sup>6</sup> switching cycles                              |
| Max. fuse rating to achieve short-circuit protection           | n/c / n/o contact  | 6 A fast-acting / 10 A fast-acting                                  |
| <b>Indication of operational states</b>                        |  |   |
| Control supply voltage   | U: green LED   | : control supply voltage applied                                    |
| Relay status R1  | R1: yellow LED   | : threshold value at input I1 exceeded                              |
| Relay status R2  | R2: yellow LED   | : threshold value at input I2 exceeded                              |
| <b>General data</b>  |  |   |
| Efficiency at rated load                                       |  | approx. 84 % (at 230 V AC)  |
| Ambient temperature range                                      | operation / storage  | 0...+55 °C / -25...+75 °C   |
| Dimensions (W x H x D)   |  | 22.5 x 78 x 100 mm (0.89 x 3.07 x 3.94 in)                          |
| Mounting position  |  | horizontally  |
| Mounting   |  | DIN rail (IEC/EN 60715)   |
| Minimum distance to other units                                |  | left-hand side 10 mm (0.39 in), vertical distance 50 mm (1.97 in)   |
| <b>Electrical connection</b>                                   |  |   |
| Wire size  |  | 2 x 2,5 mm <sup>2</sup> (2 x 14 AWG)                                |
| <b>Standards</b>   |  |   |
| Product standard   |  | IEC 255-6, EN 60255-6   |
| Electrical safety  |  | IEC(EN) 60255-5, EN 50178 (VDE 0160), EN60950, UL 508, CSA 22.2     |
| Galvanic isolation   |  | safe isolation between L+,L-, I1,I2, and L,N,11,12,14,21,22,24      |
| <b>Electromagnetic compatibility</b>                           |  |   |
| Interference immunity to                                       |  | EN 61000-6-2  |
| electrostatic discharge  | IEC/EN 61000-4-2   | Level 3 (6 / 8 kV)  |
| radiated, radio-frequency, electromagnetic field               | IEC/EN 61000-4-3   | Level 3 (10 V/m)  |
| electrical fast transient / burst                              | IEC/EN 61000-4-4   | Level 4 (4 kV)  |
| surge  | IEC/EN 61000-4-5   | Inst. class 3 (2 kV)  |
| conducted disturbances, induced by radio-frequency fields      | IEC/EN 61000-4-6   | Level 3 (10 V)  |
| Interference immunity to                                       | EN 50081-2   | radiated noise EN 55011, class B                                    |
| Input current harmonics  |  | no limitation   |
| <b>Isolation data</b>  |  |   |
| Insulation testing   |  | 2.5 kV AC (routine test), 3 kV AC (type test)                       |
| Degree of pollution  |  | 2   |
| Overvoltage category   |  | II  |

## Notes

# Cycle monitoring relay w/watchdog function



Cycle monitoring relay  
with watchdog function



# Cycle monitoring relay with watchdog function

## Ordering details



CM-WDS

### Description

The cycle monitoring relay CM-WDS (watchdog) observes if a regularly intermittent pulse is applied to its pulse input "I". It is, for example, possible to connect the output of a programmable logic controller (plc), which is set and reset regularly (e. g. once each cycle). The connected cycle pulse must be generated by suitable programming of the plc/ipc. Now, the CM-WDS monitors if the cycle time of the plc/ipc program is smaller than the cycle monitoring time set by means of the front-face selector switch "time value (ms)".

The output relay 11-12/14 of the CM-WDS energizes and the red LED is switched off, if there are minimum 8 successive regular pulses on input "I". When the pulse signal stays out or is not regular, the output relay de-energizes and the red LED is illuminated.

In case the monitoring time is too short or too long, this can be adjusted by a modified programming of the plc/ips or by modified setting of the monitoring time "time value (ms)".

A fault recognized and stored with the CM-WDS can be reset by an H-impulse (0-1-transition) on the reset input "R(9)", so that the cycle monitoring is again released. The reset impulse can be generated by means of a reset button or by suitable programming of the controller (plc/ipc).

### Ordering details

| Rated control supply voltage | Reference code | Catalog number | Weight (1 pce)<br>kg (lb) |
|------------------------------|----------------|----------------|---------------------------|
| 24 V DC                      | CM-WDS         | 1SVR430896R000 | 0.15 (0.33)               |

### Function diagram CM-WDS

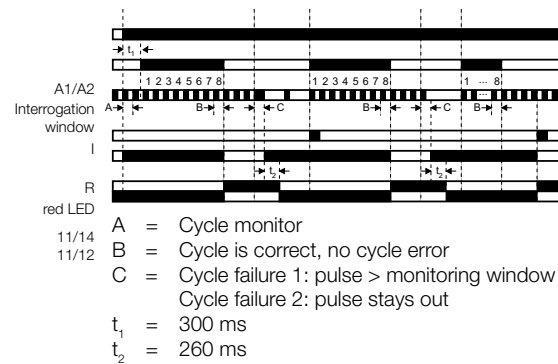

### Connection diagram CM-WDS

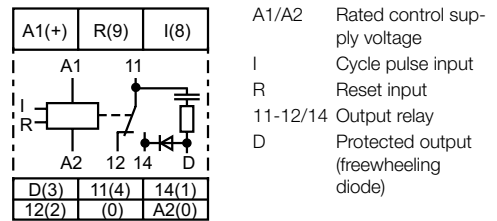

### Characteristics

- Cycle monitor for monitoring the function of programmable logic controllers or industrial pcs
- 4 selectable cycle monitoring time ranges from 0.5 to 1000 ms
- 24 V DC supply
- 1 c/o contact
- 2 LEDs for status indication

### Example of application - circuit diagram

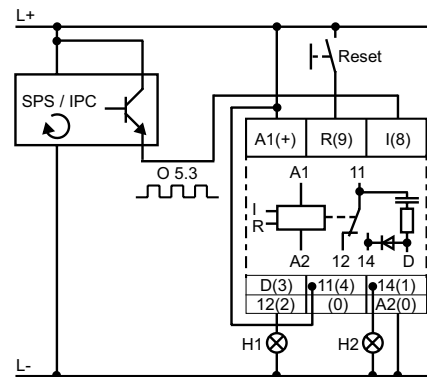

### Application

The CM-WDS is designed for the external monitoring of the correct function of programmable logic controllers (plc) and industrial pcs (ipc).

# Cycle monitoring relay with watchdog function

## Technical data

|   |  |   |
|---|--|---|
| <b>Type</b>   |  | CM-WDS  |
| <b>Input circuit</b>  |  | A1-A2   |
| Rated control supply voltage $U_s$ - power consumption A1-A2                                  |  | 24 V DC - approx. 1 W                                       |
| Tolerance of the rated control supply voltage $U_s$   |  | -30 % - +30 %   |
| Duty time   |  | 100 %   |
| <b>Measuring circuit</b>  |  | I   |
| Monitoring function   |  | cycle monitoring  |
| Measuring voltage   |  | 24 V DC   |
| Current consumption at the measuring input  |  | approx. 5 mA  |
| Setting range of cycle monitoring time  |  | selectable: 0.5-150 ms, 0.5-260 ms, 0.5-500 ms, 0.5-1000 ms |
| Response time   |  | approx. 0.5-1000 ms   |
| Accuracy within the supply voltage tolerance  |  | $\Delta U \leq 0.5 \%$                                      |
| Accuracy within the temperature range   |  | $\Delta U \leq 0.06 \%$ / °C                                |
| <b>Timing circuit</b>   |  |   |
| ON-delay  |  | approx. 2.2-10 s  |
| <b>Indication of operational states</b>   |  |   |
| Control supply voltage  |  | U: green LED  |
| Output relay de-energized / cycle error   |  | F: red LED  |
| <b>Output circuit</b>   |  | 11-12/14  |
| Kind of output  |  | 1 c/o   |
| Operating principle <sup>1)</sup>   |  | Closed-circuit principle                                    |
| Contact material  |  | AgCdo   |
| Rated operational voltage $U_o$ IEC/EN 60947-1  |  | 250 V   |
| Minimum switching voltage / Minimum switching current   |  |   |
| Maximum switching voltage   |  | 250 V AC, 250 V DC  |
| Rated operational current $I_o$ (IEC/EN 60947-5-1)  | AC12 (resistive) 230 V                             | 4 A   |
|   | AC15 (inductive) 230 V                             | 3 A   |
|   | DC12 (resistive) 24 V                              | 4 A   |
|   | DC13 (inductive) 24 V                              | 2 A   |
| AC rating (UL 508)  | Utilization category (Control Circuit Rating Code) | B 300   |
|   | max. rated operational voltage                     | 300 V AC  |
|   | max. continuous thermal current at B 300           | 5 A   |
|   | max. making/breaking apparent power at B 300       | 3600/360 VA   |
| Mechanical lifetime   |  | $10 \times 10^6$ switching cycles                           |
| Electrical lifetime (AC12, 230 V, 4 A)  |  | $0.1 \times 10^6$ switching cycles                          |
| Max. fuse rating to achieve short-circuit protection  | n/c / n/o contacts                                 | 10 A fast-acting / 10 A fast-acting                         |
| <b>General data</b>   |  |   |
| Dimensions (W x H x D)  |  | 22.5 x 78 x 100 mm (0.89 x 3.07 x 3.94 in)                  |
| Mounting position   |  | any   |
| Degree of protection  | enclosure / terminals                              | IP50 / IP20   |
| Ambient temperature range   | operation / storage                                | -20...+60 °C / -40...+85 °C                                 |
| Mounting  |  | DIN rail (IEC/EN 60715)                                     |
| <b>Electrical connection</b>  |  |   |
| Wire size   | fine-strand with wire end ferrule                  | 2 x 2.5 mm <sup>2</sup> (2 x 14 AWG)                        |
| <b>Standards</b>  |  |   |
| Product standard  |  | IEC 255-6, EN 60255-6                                       |
| Low Voltage Directive   |  | 2006/95/EC  |
| EMC Directive   |  | 2004/108/EC   |
| Operational reliability (IEC 68-2-6)  |  | 4 g   |
| Mechanical shock resistance (IEC 68-2-6)  |  | 6 g   |
| <b>Electromagnetic compatibility</b>  |  |   |
| Interference immunity to  |  | EN 61000-6-2  |
| electrostatic discharge   | IEC/EN 61000-4-2                                   | Level 3 (6 kV / 8 kV)                                       |
| radiated, radio-frequency, electromagnetic field  | IEC/EN 61000-4-3                                   | Level 3 (10 V/m)  |
| electrical fast transient / burst   | IEC/EN 61000-4-4                                   | Level 3 (2 kV / 5 kHz)                                      |
| surge   | IEC/EN 61000-4-5                                   | Level 3 (2 kV L-L)  |
| conducted disturbances, induced by radio-frequency fields                                     | IEC/EN 61000-4-6                                   | Level 3 (10 V)  |
| Interference emission   |  | EN 61000-6-4  |
| <b>Isolation data</b>   |  |   |
| Rated insulation voltage between supply-, control- and output circuit (VDE 0110, IEC 60947-1) |  | 250 V   |
| Rated impulse withstand between all isolated circuits (VDE 0110, IEC 664)                     |  | 4 kV / 1.2-50 $\mu$ s                                       |
| Test voltage between all isolated circuits  |  | 2.5 kV, 50 Hz, 1 min  |
| Pollution degree (VDE 0110, IEC 664, IEC 255-5)   |  | 3/C   |
| Overvoltage category (VDE 0110, IEC 664, IEC 255-5)   |  | III   |
| Environmental tests (IEC 68-2-30)   |  | 24 h cycle, 55 °C, 93 % rel. 96 h                           |

<sup>1)</sup> Closed-circuit principle: Output relay de-energizes if a cycle error occurs

# General technical data

## Load limit curves

### Load limit curves

#### CM-S (22.5 mm), CM-E (22.5 mm)

AC load (resistive)

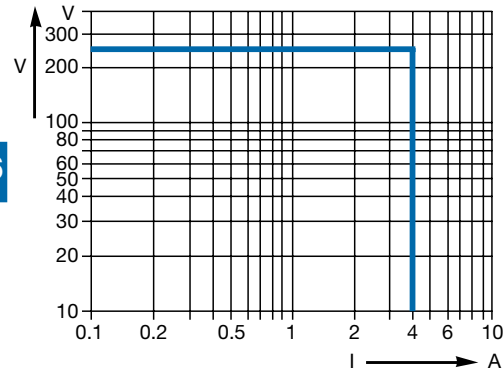

DC load (resistive)

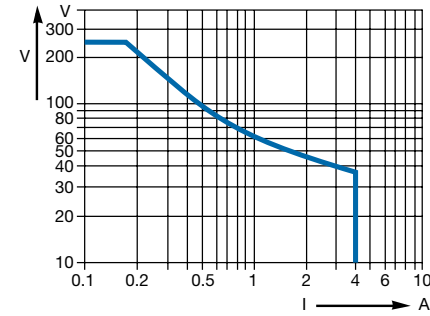

Contact lifetime

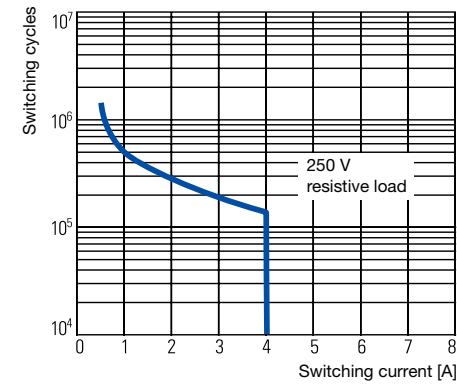

Derating factor F for inductive AC load

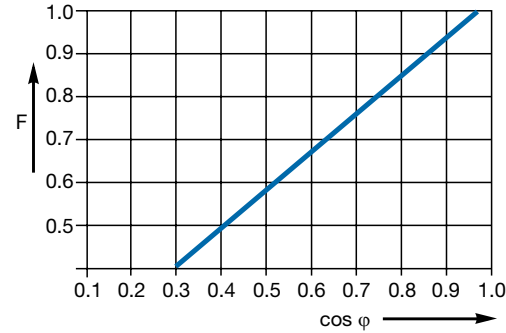

#### CM-N (45 mm)

AC load (resistive)

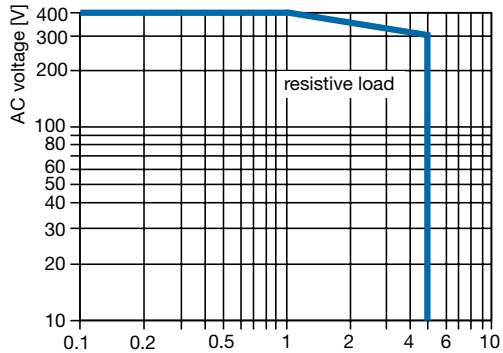

DC load (resistive)

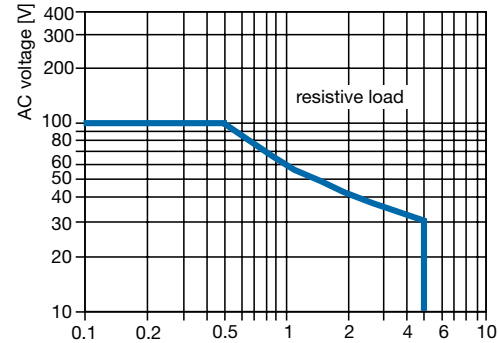

Contact lifetime

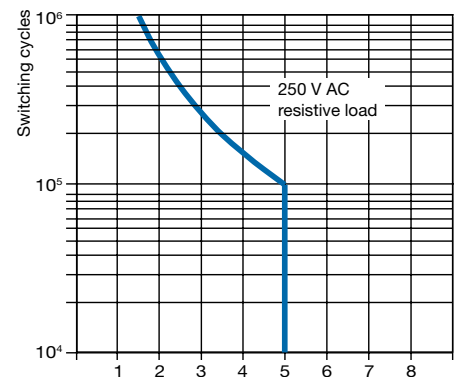

Derating factor F for inductive AC load

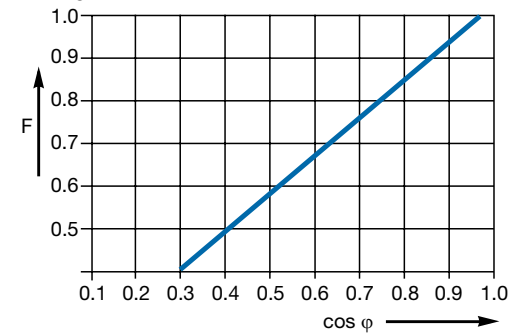

# General technical data

## Approximate dimensions

### Measuring and monitoring relays CM range old housing

Dimensions in mm

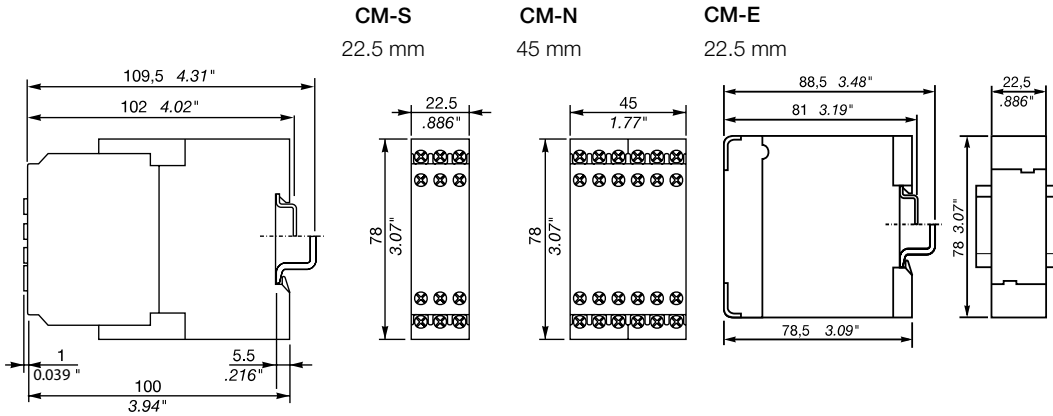

### Measuring and monitoring relays CM range new housing

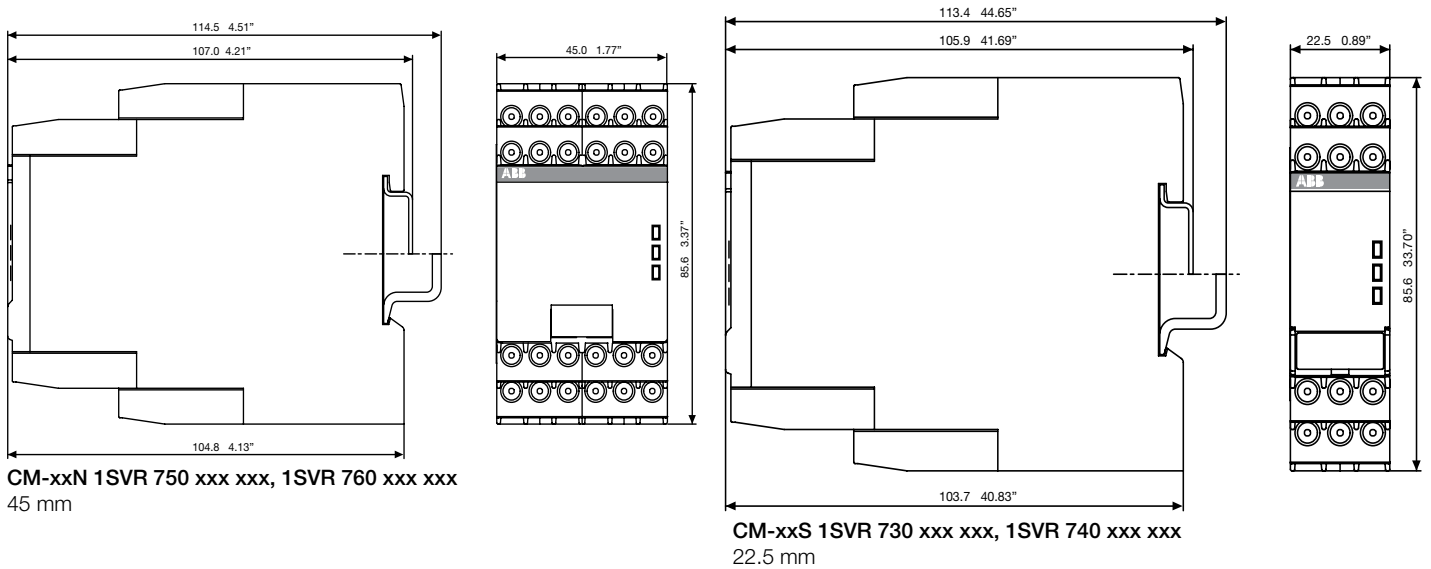

### Temperature monitoring relays

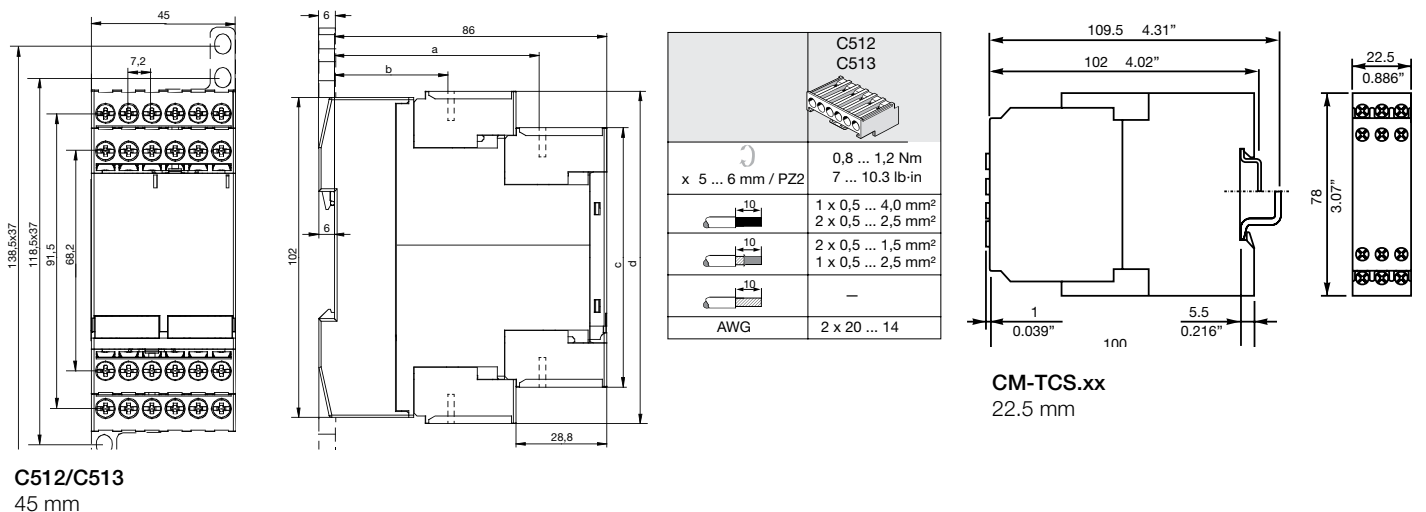

## Accessories

### Ordering details

### Accessories

#### Ordering details

| Description                | For type                  | Width in mm | for devices          | Reference code | Catalog number  | Pkg qty | Weight (1 pce)<br>g (oz) |
|----------------------------|---------------------------|-------------|----------------------|----------------|-----------------|---------|--------------------------|
| Adapter for screw mounting | CM-S                      | 22.5        |                      | ADP.01         | 1SVR430029R0100 | 1       | 18.4 (0.65)              |
|                            | CM-N                      | 45          |                      | ADP.02         | 1SVR440029R0100 | 1       | 36.7 (1.30)              |
| Marker label               | CM-S, CM-N                |             | without DIP switches | MAR.01         | 1SVR366017R0100 | 10      | 0.19 (0.007)             |
|                            | CM-S, CM-N                |             | with DIP switches    | MAR.02         | 1SVR430043R0000 | 10      | 0.13 (0.005)             |
|                            | CM-S, CM-N in new housing |             | with DIP switches    | MAR.12         | 1SVR730006R0000 | 10      | 0.152 (0.335)            |
| Sealable transparent cover | CM-S                      | 22.5        |                      | COV.01         | 1SVR430005R0100 | 1       | 5.2 (0.18)               |
|                            | CM-N                      | 45          |                      | COV.02         | 1SVR440005R0100 | 1       | 7.7 (0.27)               |
|                            | CM-S.S/P                  | 22.5        |                      | COV.11         | 1SVR730005R0100 | 1       | 4.0 (0.129)              |
|                            | CM-N.S/P                  | 45          |                      | COV.12         | 1SVR750005R0100 | 1       | 7 (0.247)                |

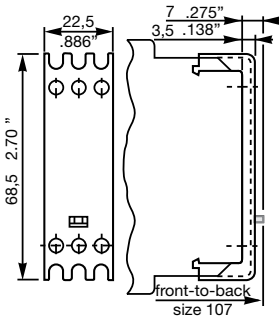
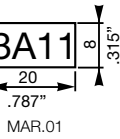
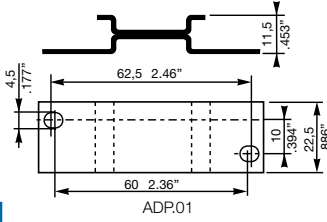

Sealable cover  
COV.01

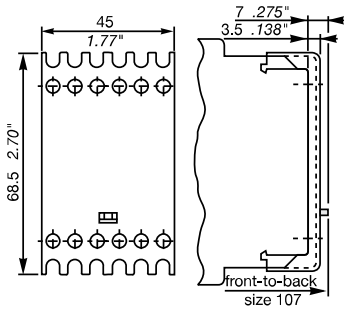

Sealable cover  
COV.02



## Accessories

### Ordering details



CM-CT



CM-CT with mounted accessories

### Plug-in current transformers CM-CT

- Without primary conductor though with foot angle, insulating protective cap and bar fastening screws
- Primary / rated current from 50 A to 600 A
- Secondary current of 1 A or 5 A
- Class 1

### Ordering details

| Rated primary current | Secondary current | Burden class | Reference code | Catalog number  | Weight (1 pce) g (oz) |
|-----------------------|-------------------|--------------|----------------|-----------------|-----------------------|
| 50 A                  | 1 A               | 1 VA / 1     | CM-CT 50/1     | 1SVR450116R1000 | 0.31 (0.683)          |
| 75 A                  |                   | 1.5 VA / 1   | CM-CT 75/1     | 1SVR450116R1100 | 0.31 (0.683)          |
| 100 A                 |                   | 2.5 VA / 1   | CM-CT 100/1    | 1SVR450116R1200 | 0.276 (0.608)         |
| 150 A                 |                   | 2.5 VA / 1   | CM-CT 150/1    | 1SVR450116R1300 | 0.32 (0.705)          |
| 200 A                 |                   | 2.5 VA / 1   | CM-CT 200/1    | 1SVR450116R1400 | 0.222 (0.489)         |
| 300 A                 |                   | 5 VA / 1     | CM-CT 300/1    | 1SVR450117R1100 | 0.29 (0.639)          |
| 400 A                 |                   | 5 VA / 1     | CM-CT 400/1    | 1SVR450117R1200 | 0.27 (0.595)          |
| 500 A                 |                   | 5 VA / 1     | CM-CT 500/1    | 1SVR450117R1300 | 0.29 (0.639)          |
| 600 A                 |                   | 5 VA / 1     | CM-CT 600/1    | 1SVR450117R1400 | 0.24 (0.529)          |
| 50 A                  |                   | 5 A          | 1 VA / 1       | CM-CT 50/5      | 1SVR450116R5000       |
| 75 A                  | 1.5 VA / 1        |              | CM-CT 75/5     | 1SVR450116R5100 | 0.31 (0.683)          |
| 100 A                 | 2.5 VA / 1        |              | CM-CT 100/5    | 1SVR450116R5200 | 0.31 (0.683)          |
| 150 A                 | 2.5 VA / 1        |              | CM-CT 150/5    | 1SVR450116R5300 | 0.28 (0.617)          |
| 200 A                 | 5 VA / 1          |              | CM-CT 200/5    | 1SVR450116R5400 | 0.29 (0.639)          |
| 300 A                 | 5 VA / 1          |              | CM-CT 300/5    | 1SVR450117R5100 | 0.252 (0.556)         |
| 400 A                 | 5 VA / 1          |              | CM-CT 400/5    | 1SVR450117R5200 | 0.26 (0.573)          |
| 500 A                 | 5 VA / 1          |              | CM-CT 500/5    | 1SVR450117R5300 | 0.208 (0.459)         |
| 600 A                 | 5 VA / 1          |              | CM-CT 600/5    | 1SVR450117R5400 | 0.21 (0.463)          |

### Ordering details - Accessories

| Description                                     | Reference code | Catalog number  | Weight (1 pce) g (oz) |
|---|----------------|-----------------|-----------------------|
| Snap-on fastener for DIN rail mounting of CM-CT | CM-CT A        | 1SVR450118R1000 | 0.009 (0.02)          |



CM-CT-A mounted on DIN rail

### Operating principle / circuit diagram

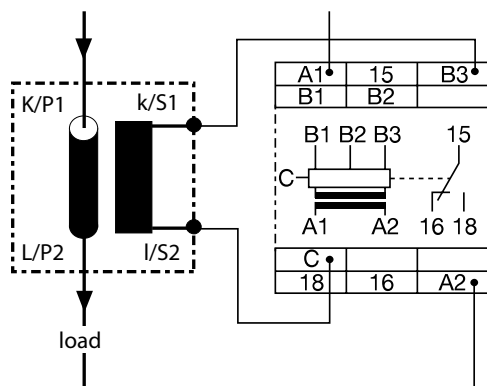

### Dimensional drawing

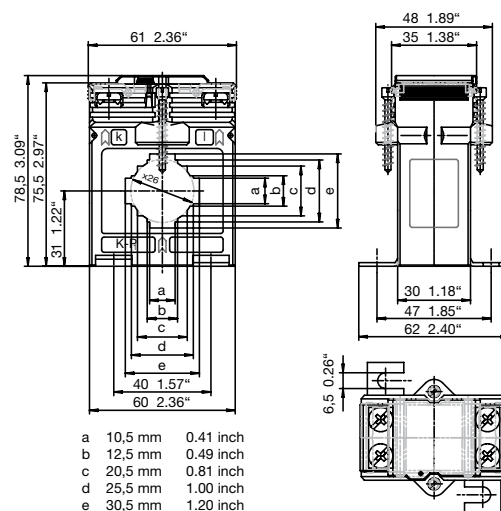

## Notes

# CR Range Interface Relays & optocouplers



CR Range  
Interface relays & optocouplers

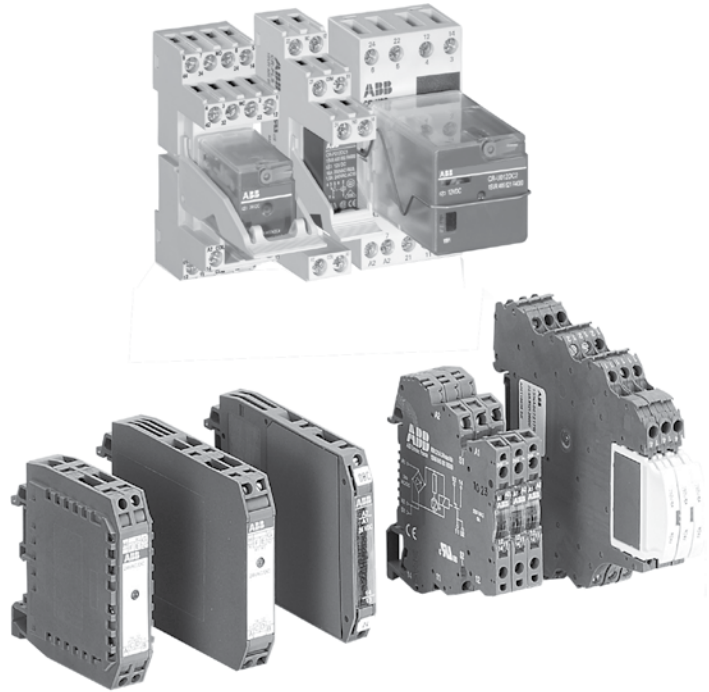

# Notes

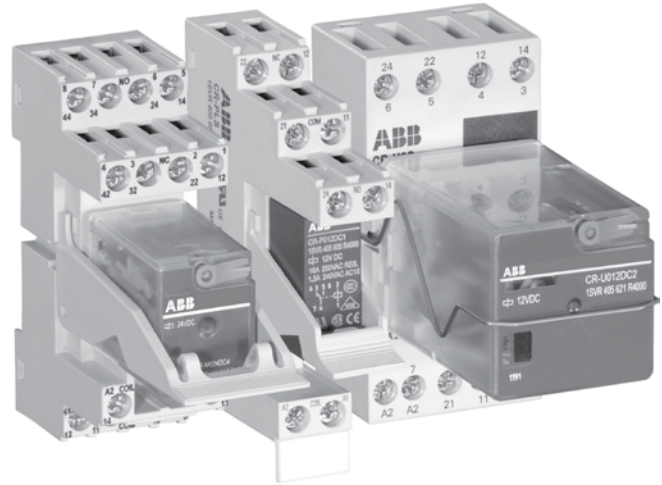

# CR Range Interface Relays

## Pluggable interface relays Benefits and advantages

### Pluggable pcb relays CR-P

- 9 different coil voltages
  - DC versions: 12 V, 24 V, 48 V, 110 V
  - AC versions: 24 V, 48 V, 110 V, 120 V, 230 V
- Output contacts:
  - 1 c/o contact (16 A) or
  - 2 c/o contacts (8 A) optionally equipped with gold contacts
- Logical or standard sockets
- Cadmium-free contact material
- Width on socket: 15,5 mm
- Pluggable function modules
  - Reverse polarity protection/ Free wheeling diode
  - LED indication
  - RC elements
  - Overvoltage protection

### Pluggable miniature relays CR-M

- 12 different coil voltages
  - DC versions: 12 V, 24 V, 48 V, 60 V, 110 V, 125 V, 220 V
  - AC versions: 24 V, 48 V, 60 V, 110 V, 120 V, 230 V
- Output contacts
  - 2 c/o contacts (12 A) or
  - 3 c/o contacts (10 A) or
  - 4 c/o contacts (6 A) optionally equipped with gold contacts, LED and free wheeling diode
- Integrated test button for manual actuation and locking of the output contacts (blue = DC, orange = AC) that can be removed if necessary
- With or without integrated LED
- Logical or standard sockets
- Cadmium-free contact material
- Width on socket: 27 mm
- Pluggable function modules
  - Reverse polarity protection/ Free wheeling diode
  - LED indication
  - RC elements
  - Overvoltage protection

### Pluggable universal relays CR-U

- 10 different coil voltages
  - DC versions: 12 V, 24 V, 48 V, 110 V, 125 V, 220 V
  - AC versions: 24 V, 48 V, 60 V, 110 V, 120 V, 230 V
- Output contacts
  - 2 c/o contacts (10 A) or
  - 3 c/o contacts (10 A)
- Integrated test button for manual actuation and locking of the output contacts (blue = DC, orange = AC) that can be removed if necessary
- With or without integrated LED
- Cadmium-free contact material
- Width on socket: 38 mm
- Pluggable function modules
  - Reverse polarity protection/ Free wheeling diode
  - LED indication
  - RC elements
  - Overvoltage protection
  - Multifunction time module

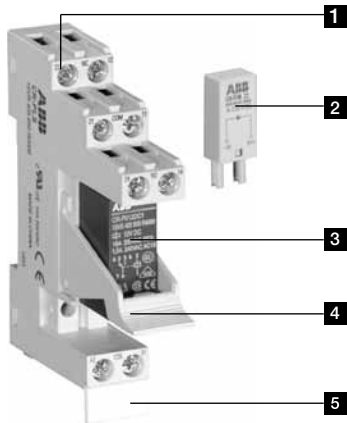

- 1** Socket
- 2** Pluggable function module
- 3** Interface relay
- 4** Holder
- 5** Marker label

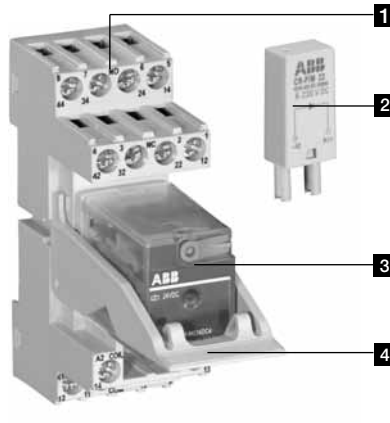

- 1** Socket
- 2** Pluggable function module
- 3** Interface relay
- 4** Holder



- 1** Socket
- 2** Pluggable function module
- 3** Interface relay
- 4** Holder

# Pluggable interface relays

## Approvals and marks

### Kinds of sockets

#### Standard sockets - Position of connecting terminals:

Coil connection (A1-A2) on lower socket side, contact connections (n/o and n/c contacts) on the lower and upper socket side.

#### Logical sockets - Position of connecting terminals:

Coil connection (A1-A2) on lower socket side, all contact connections (common contacts, n/o and n/c contacts) on upper socket side.

Details see connection diagrams

### Kind of connecting terminals

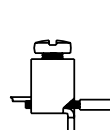

Screw type



Spring type

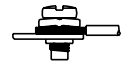

Fork type

### Approvals and marks

|                  |                     | Relays |                 |      | Sockets          |        |                      |          |                    |          |                 | Modules         |  |
|------------------|---------------------|--------|-----------------|------|------------------|--------|----------------------|----------|--------------------|----------|-----------------|-----------------|--|
|                  |                     | CR-P   | CR-M            | CR-U | CR-PLS<br>CR-PSS | CR-PLC | CR-M..L.<br>CR-M..SS | CR-M..SF | CR-U..S<br>CR-U..E | CR-U..SM | CR-P/M          | CR-U            |  |
| <b>Approvals</b> |                     |        |                 |      |                  |        |                      |          |                    |          |                 |                 |  |
|                  | UL 508              | ■      | ■ <sup>1)</sup> | ■    |                  |        |                      |          |                    |          |                 |                 |  |
|                  | CAN/CSA C22.2 No.14 | ■      | ■ <sup>2)</sup> | ■    | ■                | ■      | ■                    | ■        | ■                  | ■        | ■ <sup>6)</sup> | ■ <sup>7)</sup> |  |
|                  | CAN/CSA C22.2 No.14 | ■      | ■ <sup>3)</sup> | ■    |                  |        |                      |          |                    |          |                 |                 |  |
|                  | VDE                 | ■      | ■ <sup>4)</sup> | ■    |                  |        |                      |          |                    |          |                 |                 |  |
|                  | GOST                | ■      | ■               | ■    | ■                | ■      | ■                    | ■        | ■                  | ■        | ■               | ■               |  |
|                  | Lloyds Register     |        | ■ <sup>5)</sup> | ■    |                  |        |                      |          |                    |          |                 |                 |  |
|                  | CCC                 | ■      | ■               | ■    |                  |        |                      |          |                    |          |                 |                 |  |
|                  | RMRS                | ■      | ■               | ■    | ■                | ■      | ■                    | ■        | ■                  | ■        |                 |                 |  |
| <b>Marks</b>     |                     |        |                 |      |                  |        |                      |          |                    |          |                 |                 |  |
|                  | CE                  | ■      | ■               | ■    | ■                | ■      | ■                    | ■        | ■                  | ■        | ■               | ■               |  |

<sup>1)</sup> except 60 V DC and 125 V DC devices with gold contacts

<sup>2)</sup> except devices with gold contacts

<sup>3)</sup> except 60 V DC and 125 V DC devices

<sup>4)</sup> except 125 V DC devices

<sup>5)</sup> only devices with 4 c/o contacts

<sup>6)</sup> except CR-P/M 42B, CR-P/M 42BV, CR-P/M 42C, CR-P/M 42CV, CR-P/M 52D, CR-P/M 62E, CR-P/M 62EV, CR-P/M 62D, CR-P/M 62DV

<sup>7)</sup> except CR-U 41B, CR-U 41BV, CR-U 41C, CR-U 41CV, CR-U 51D, CR-U 61CV, CR-U 61E, CR-U 61EV, CR-U 61D, CR-U 61DV, CR-U 91C, CR-U T

## Pluggable interface relays

### Ordering details



CR-P

#### Description

Interface relays are widely used in various industrial applications:

As an interface they link the electronic controlling, e.g. PLC (programmable logic controller), PC or field bus systems, to the sensor / actuator level. Here, they take on various functions: Switching of AC or DC loads with different resistive, inductive and capacitive parts, switching voltages from a few mV up to 250 V, switching currents from a few mA up to 16 A, amplification of weak control signals, electrical isolation of control and load circuits, and signal multiplying. In contrast to electronic switching devices, interface relays don't use additional internal protective circuits and thus are overload-proof against short-time variations like current or voltage peaks.

#### Ordering details - CR-P range

| Rated control supply voltage | Outputs               | Contact ratings | Reference code | Catalog number  | Pkg        | Weight             |
|------------------------------|-----------------------|-----------------|----------------|-----------------|------------|--------------------|
|                              |                       |                 |                |                 | qty        | (1 pce)<br>kg (lb) |
| 12 V DC                      | 1 c/o (SPDT)          | 250 V, 16 A     | CR-P012DC1     | 1SVR405600R4000 | 10         | 0.014<br>(0.031)   |
| 24 V DC                      |                       |                 | CR-P024DC1     | 1SVR405600R1000 |            |                    |
| 48 V DC                      |                       |                 | CR-P048DC1     | 1SVR405600R6000 |            |                    |
| 110 V DC                     |                       |                 | CR-P110DC1     | 1SVR405600R8000 |            |                    |
| 24 V AC                      |                       |                 | CR-P024AC1     | 1SVR405600R0000 |            |                    |
| 48 V AC                      |                       |                 | CR-P048AC1     | 1SVR405600R5000 |            |                    |
| 110 V AC                     |                       |                 | CR-P110AC1     | 1SVR405600R7000 |            |                    |
| 120 V AC                     |                       |                 | CR-P120AC1     | 1SVR405600R2000 |            |                    |
| 230 V AC                     |                       |                 | CR-P230AC1     | 1SVR405600R3000 |            |                    |
| 12 V DC                      |                       |                 | 2 c/o (SPDT)   | 250 V, 8 A      |            |                    |
| 24 V DC                      | CR-P024DC2            | 1SVR405601R1000 |                |                 |            |                    |
| 48 V DC                      | CR-P048DC2            | 1SVR405601R6000 |                |                 |            |                    |
| 110 V DC                     | CR-P110DC2            | 1SVR405601R8000 |                |                 |            |                    |
| 24 V AC                      | CR-P024AC2            | 1SVR405601R0000 |                |                 |            |                    |
| 48 V AC                      | CR-P048AC2            | 1SVR405601R5000 |                |                 |            |                    |
| 110 V AC                     | CR-P110AC2            | 1SVR405601R7000 |                |                 |            |                    |
| 120 V AC                     | CR-P120AC2            | 1SVR405601R2000 |                |                 |            |                    |
| 230 V AC                     | CR-P230AC2            | 1SVR405601R3000 |                |                 |            |                    |
| 24 V DC                      | 2 c/o<br>gold contact | 250 V, 8 A      |                |                 | CR-P024DC2 | 1SVR405606R1000    |
| 24 V AC                      |                       |                 | CR-P024AC2G    | 1SVR405606R0000 |            |                    |
| 110 V AC                     |                       |                 | CR-P110AC2G    | 1SVR405606R7000 |            |                    |
| 230 V AC                     |                       |                 | CR-P230AC2G    | 1SVR405606R3000 |            |                    |



CR-PLS



CR-PJ

#### Ordering details - Accessories

| Version                                      | Connection terminal | Reference code | Catalog number  | Pkg | Weight             |
|--|---------------------|----------------|-----------------|-----|--------------------|
|  |                     |                |                 | qty | (1 pce)<br>kg (lb) |
| Logical socket with protective separation    | screw               | CR-PLS         | 1SVR405650R0000 | 10  | 0.045<br>(0.099)   |
| Logical socket                               | screw               | CR-PLSx        | 1SVR405650R0100 |     | 0.043<br>(0.095)   |
| Logical socket                               | spring              | CR-PLC         | 1SVR405650R0200 |     | 0.042<br>(0.093)   |
| Standard socket                              | screw               | CR-PSS         | 1SVR405650R1000 |     | 0.038<br>(0.084)   |
| Plastic Holder for socket                    |                     | CR-PH          | 1SVR405659R0000 | 10  | 0.002<br>(0.004)   |
| Jumper bar for sockets with screw connection |                     | CR-PJ          | 1SVR405658R5000 |     | 0.018<br>(0.040)   |
| Marker                                       |                     | CR-PM          | 1SVR405658R0000 | 10  | 0.0002<br>(0.0004) |



# Pluggable interface relays

## Ordering details

Interface relays  
CR Range



CR-M

### Description

Interface relays are widely used in various industrial applications:

As an interface they link the electronic controlling, e.g. PLC (programmable logic controller), PC or field bus systems, to the sensor / actuator level. Here, they take on various functions: Switching of AC or DC loads with different resistive, inductive and capacitive parts, switching voltages from a few mV up to 250 V, switching currents from a few mA up to 16 A, amplification of weak control signals, electrical isolation of control and load circuits, and signal multiplying. In contrast to electronic switching devices, interface relays don't use additional internal protective circuits and thus are overload-proof against short-time variations like current or voltage peaks.

### Ordering details - CR-M range

| Rated control supply voltage | Outputs                     | Contact ratings | Reference code              | Catalog number  | Pkg        | Weight             |
|------------------------------|-----------------------------|-----------------|-----------------------------|-----------------|------------|--------------------|
|                              |                             |                 |                             |                 | qty        | (1 pce)<br>kg (lb) |
| 12 V DC                      | 2 c/o (SPDT)<br>without LED | 250 V, 12 A     | CR-M012DC2                  | 1SVR405611R4000 | 10         | 0.033<br>(0.073)   |
| 24 V DC                      |                             |                 | CR-M024DC2                  | 1SVR405611R1000 |            |                    |
| 48 V DC                      |                             |                 | CR-M048DC2                  | 1SVR405611R6000 |            |                    |
| 60 V DC                      |                             |                 | CR-M060DC2                  | 1SVR405611R4200 |            |                    |
| 110 V DC                     |                             |                 | CR-M110DC2                  | 1SVR405611R8000 |            |                    |
| 125 V DC                     |                             |                 | CR-M125DC2                  | 1SVR405611R8200 |            |                    |
| 220 V DC                     |                             |                 | CR-M220DC2                  | 1SVR405611R9000 |            |                    |
| 24 V AC                      |                             |                 | CR-M024AC2                  | 1SVR405611R0000 |            |                    |
| 48 V AC                      |                             |                 | CR-M048AC2                  | 1SVR405611R5000 |            |                    |
| 110 V AC                     |                             |                 | CR-M110AC2                  | 1SVR405611R7000 |            |                    |
| 120 V AC                     |                             |                 | CR-M120AC2                  | 1SVR405611R2000 |            |                    |
| 230 V AC                     |                             |                 | CR-M230AC2                  | 1SVR405611R3000 |            |                    |
| 12 V DC                      |                             |                 | 3 c/o (SPDT)<br>without LED | 250 V, 10 A     |            |                    |
| 24 V DC                      | CR-M024DC3                  | 1SVR405612R1000 |                             |                 |            |                    |
| 48 V DC                      | CR-M048DC3                  | 1SVR405612R6000 |                             |                 |            |                    |
| 60 V DC                      | CR-M060DC3                  | 1SVR405612R4200 |                             |                 |            |                    |
| 110 V DC                     | CR-M110DC3                  | 1SVR405612R8000 |                             |                 |            |                    |
| 125 V DC                     | CR-M125DC3                  | 1SVR405612R8200 |                             |                 |            |                    |
| 220 V DC                     | CR-M220DC3                  | 1SVR405612R9000 |                             |                 |            |                    |
| 24 V AC                      | CR-M024AC3                  | 1SVR405612R0000 |                             |                 |            |                    |
| 48 V AC                      | CR-M048AC3                  | 1SVR405612R5000 |                             |                 |            |                    |
| 110 V AC                     | CR-M110AC3                  | 1SVR405612R7000 |                             |                 |            |                    |
| 120 V AC                     | CR-M120AC3                  | 1SVR405612R2000 |                             |                 |            |                    |
| 230 V AC                     | CR-M230AC3                  | 1SVR405612R3000 |                             |                 |            |                    |
| 12 V DC                      | 4 c/o (SPDT)<br>without LED | 250 V, 6 A      |                             |                 | CR-M012DC4 | 1SVR405613R4000    |
| 24 V DC                      |                             |                 | CR-M024DC4                  | 1SVR405613R1000 |            |                    |
| 48 V DC                      |                             |                 | CR-M048DC4                  | 1SVR405613R6000 |            |                    |
| 60 V DC                      |                             |                 | CR-M060DC4                  | 1SVR405613R4200 |            |                    |
| 110 V DC                     |                             |                 | CR-M110DC4                  | 1SVR405613R8000 |            |                    |
| 125 V DC                     |                             |                 | CR-M125DC4                  | 1SVR405613R8200 |            |                    |
| 220 V DC                     |                             |                 | CR-M220DC4                  | 1SVR405613R9000 |            |                    |
| 24 V AC                      |                             |                 | CR-M024AC4                  | 1SVR405613R0000 |            |                    |
| 48 V AC                      |                             |                 | CR-M048AC4                  | 1SVR405613R5000 |            |                    |
| 110 V AC                     |                             |                 | CR-M110AC4                  | 1SVR405613R7000 |            |                    |
| 120 V AC                     |                             |                 | CR-M120AC4                  | 1SVR405613R2000 |            |                    |
| 230 V AC                     |                             |                 | CR-M230AC4                  | 1SVR405613R3000 |            |                    |

## Pluggable interface relays

### Ordering details



CR-M

#### Ordering details - CR-M range

| Rated control supply voltage | Outputs                  | Contact ratings | Reference code                                 | Catalog number  | Pkg          | Weight             |             |                  |    |                  |
|------------------------------|--------------------------|-----------------|--|-----------------|--------------|--------------------|-------------|------------------|----|------------------|
|                              |                          |                 |  |                 | qty          | (1 pce)<br>kg (lb) |             |                  |    |                  |
| 12 V DC                      | 2 c/o (SPDT)<br>with LED | 250 V, 12 A     | CR-M012DC2L                                    | 1SVR405611R4100 | 10           | 0.033<br>(0.073)   |             |                  |    |                  |
| 24 V DC                      |                          |                 | CR-M024DC2L                                    | 1SVR405611R1100 |              |                    |             |                  |    |                  |
| 48 V DC                      |                          |                 | CR-M048DC2L                                    | 1SVR405611R6100 |              |                    |             |                  |    |                  |
| 60 V DC                      |                          |                 | CR-M060DC2L                                    | 1SVR405611R4300 |              |                    |             |                  |    |                  |
| 110 V DC                     |                          |                 | CR-M110DC2L                                    | 1SVR405611R8100 |              |                    |             |                  |    |                  |
| 125 V DC                     |                          |                 | CR-M125DC2L                                    | 1SVR405611R8300 |              |                    |             |                  |    |                  |
| 220 V DC                     |                          |                 | CR-M220DC2L                                    | 1SVR405611R9100 |              |                    |             |                  |    |                  |
| 24 V AC                      |                          |                 | CR-M024AC2L                                    | 1SVR405611R0100 |              |                    |             |                  |    |                  |
| 48 V AC                      |                          |                 | CR-M048AC2L                                    | 1SVR405611R5100 |              |                    |             |                  |    |                  |
| 110 V AC                     |                          |                 | CR-M110AC2L                                    | 1SVR405611R7100 |              |                    |             |                  |    |                  |
| 120 V AC                     |                          |                 | CR-M120AC2L                                    | 1SVR405611R2100 |              |                    |             |                  |    |                  |
| 230 V AC                     |                          |                 | CR-M230AC2L                                    | 1SVR405611R3100 |              |                    |             |                  |    |                  |
| 12 V DC                      |                          |                 | 3 c/o (SPDT)<br>with LED                       | 250 V, 10 A     |              |                    | CR-M012DC3L | 1SVR405612R4100  | 10 | 0.033<br>(0.073) |
| 24 V DC                      |                          |                 |  |                 |              |                    | CR-M024DC3L | 1SVR405612R1100  |    |                  |
| 48 V DC                      |                          |                 |  |                 |              |                    | CR-M048DC3L | 1SVR405612R6100  |    |                  |
| 60 V DC                      | CR-M060DC3L              | 1SVR405612R4300 |  |                 |              |                    |             |                  |    |                  |
| 110 V DC                     | CR-M110DC3L              | 1SVR405612R8100 |  |                 |              |                    |             |                  |    |                  |
| 125 V DC                     | CR-M125DC3L              | 1SVR405612R8300 |  |                 |              |                    |             |                  |    |                  |
| 220 V DC                     | CR-M220DC3L              | 1SVR405612R9100 |  |                 |              |                    |             |                  |    |                  |
| 24 V AC                      | CR-M024AC3L              | 1SVR405612R0100 |  |                 |              |                    |             |                  |    |                  |
| 48 V AC                      | CR-M048AC3L              | 1SVR405612R5100 |  |                 |              |                    |             |                  |    |                  |
| 110 V AC                     | CR-M110AC3L              | 1SVR405612R7100 |  |                 |              |                    |             |                  |    |                  |
| 120 V AC                     | CR-M120AC3L              | 1SVR405612R2100 |  |                 |              |                    |             |                  |    |                  |
| 230 V AC                     | CR-M230AC3L              | 1SVR405612R3100 |  |                 |              |                    |             |                  |    |                  |
| 12 V DC                      | 4 c/o (SPDT)<br>with LED | 250 V, 6 A      |  |                 | CR-M012DC4L  | 1SVR405613R4100    | 10          | 0.033<br>(0.073) |    |                  |
| 24 V DC                      |                          |                 |  |                 | CR-M024DC4L  | 1SVR405613R1100    |             |                  |    |                  |
| 48 V DC                      |                          |                 |  |                 | CR-M048DC4L  | 1SVR405613R6100    |             |                  |    |                  |
| 60 V DC                      |                          |                 | CR-M060DC4L                                    | 1SVR405613R4300 |              |                    |             |                  |    |                  |
| 110 V DC                     |                          |                 | CR-M110DC4L                                    | 1SVR405613R8100 |              |                    |             |                  |    |                  |
| 125 V DC                     |                          |                 | CR-M125DC4L                                    | 1SVR405613R8300 |              |                    |             |                  |    |                  |
| 220 V DC                     |                          |                 | CR-M220DC4L                                    | 1SVR405613R9100 |              |                    |             |                  |    |                  |
| 24 V AC                      |                          |                 | CR-M024AC4L                                    | 1SVR405613R0100 |              |                    |             |                  |    |                  |
| 48 V AC                      |                          |                 | CR-M048AC4L                                    | 1SVR405613R5100 |              |                    |             |                  |    |                  |
| 110 V AC                     |                          |                 | CR-M110AC4L                                    | 1SVR405613R7100 |              |                    |             |                  |    |                  |
| 120 V AC                     |                          |                 | CR-M120AC4L                                    | 1SVR405613R2100 |              |                    |             |                  |    |                  |
| 230 V AC2                    |                          |                 | CR-M230AC4L                                    | 1SVR405613R3100 |              |                    |             |                  |    |                  |
| 24 V DC                      |                          |                 | 4 c/o (SPDT) LED<br>and free-wheeling<br>diode | 250 V, 6 A      | CR-M024DC4LD | 1SVR405614R1100    |             |                  | 10 | 0.033<br>(0.073) |
| 24 V DC                      |                          |                 | 4 (SPDT) c/o<br>gold contacts                  | 250 V, 6 A      | CR-M024DC4G  | 1SVR405618R1000    |             |                  | 10 | 0.033<br>(0.073) |
| 24 V AC                      |                          |                 |  |                 | CR-M024AC4G  | 1SVR405618R0000    |             |                  |    |                  |
| 110 V AC                     | CR-M110AC4G              | 1SVR405618R7000 |  |                 |              |                    |             |                  |    |                  |
| 230 V AC                     | CR-M230AC4G              | 1SVR405618R3000 |  |                 |              |                    |             |                  |    |                  |

# Pluggable interface relays

## Ordering details

Interface relays  
CR Range



CR-M

| Rated control supply voltage | Outputs                                 | Contact ratings | Reference code   | Catalog number  | Pkg | Weight             |               |                 |    |                  |
|------------------------------|---|-----------------|--|-----------------|-----|--------------------|---------------|-----------------|----|------------------|
|                              |   |                 |  |                 | qty | (1 pce)<br>kg (lb) |               |                 |    |                  |
| 12 V DC                      | 4 c/o (SPDT) with gold contacts and LED | 250 V / 6 A     | CR-M012DC4LG   | 1SVR405618R4100 | 10  | 0.033<br>(0.073)   |               |                 |    |                  |
| 24 V DC                      |   |                 | CR-M024DC4LG   | 1SVR405618R1100 |     |                    |               |                 |    |                  |
| 48 V DC                      |   |                 | CR-M048DC4LG   | 1SVR405618R6100 |     |                    |               |                 |    |                  |
| 60 V DC                      |   |                 | CR-M060DC4LG   | 1SVR405618R4300 |     |                    |               |                 |    |                  |
| 110 V DC                     |   |                 | CR-M110DC4LG   | 1SVR405618R8100 |     |                    |               |                 |    |                  |
| 125 V DC                     |   |                 | CR-M125DC4LG   | 1SVR405618R8300 |     |                    |               |                 |    |                  |
| 220 V DC                     |   |                 | CR-M220DC4LG   | 1SVR405618R9100 |     |                    |               |                 |    |                  |
| 24 V AC                      |   |                 | CR-M024AC4LG   | 1SVR405618R0100 | 10  | 0.033<br>(0.073)   |               |                 |    |                  |
| 48 V AC                      |   |                 | CR-M048AC4LG   | 1SVR405618R5100 |     |                    |               |                 |    |                  |
| 110 V AC                     |   |                 | CR-M110AC4LG   | 1SVR405618R7100 |     |                    |               |                 |    |                  |
| 120 V AC                     |   |                 | CR-M120AC4LG   | 1SVR405618R2100 |     |                    |               |                 |    |                  |
| 230 V AC                     |   |                 | CR-M230AC4LG   | 1SVR405618R3100 |     |                    |               |                 |    |                  |
| 12 V DC                      |   |                 | 4 c/o (SPDT) with gold contacts, LED and free-wheeling diode |                 |     |                    | CR-M012DC4LDG | 1SVR405618R4400 | 10 | 0.033<br>(0.073) |
| 24 V DC                      |   |                 |  |                 |     |                    | CR-M024DC4LDG | 1SVR405618R1400 |    |                  |

6



CR-M4SS



CR-MJ

### Ordering details - Accessories

| Version                     | Connection terminal | Reference code | Catalog number  | Pkg | Weight             |
|-----------------------------|---------------------|----------------|-----------------|-----|--------------------|
|                             |                     |                |                 | qty | (1 pce)<br>kg (lb) |
| Logical socket for 2 c/o    | screw               | CR-M2LS        | 1SVR405651R1100 | 10  | 0.055<br>(0.121)   |
| Logical socket for 3 c/o    |                     | CR-M3LS        | 1SVR405651R2100 |     | 0.062<br>(0.137)   |
| Logical socket for 2/4 c/o  |                     | CR-M4LS        | 1SVR405651R3100 |     | 0.066<br>(0.146)   |
| Logical socket for 2 c/o    | spring              | CR-M2LC        | 1SVR405651R1200 | 10  | 0.065<br>(0.143)   |
| Logical socket for 2/4 c/o  |                     | CR-M4LC        | 1SVR405651R3200 |     | 0.066<br>(0.146)   |
| Standard socket for 2 c/o   | screw               | CR-M2SS        | 1SVR405651R1000 | 10  | 0.066<br>(0.146)   |
| Standard socket for 3 c/o   |                     | CR-M3SS        | 1SVR405651R2000 |     | 0.068<br>(0.150)   |
| Standard socket for 2/4 c/o |                     | CR-M4SS        | 1SVR405651R3000 |     | 0.070<br>(0.154)   |
| Standard socket for 2 c/o   | fork type           | CR-M2SF        | 1SVR405651R1300 | 10  | 0.040<br>(0.088)   |
| Standard socket for 2/4 c/o |                     | CR-M4SF        | 1SVR405651R3300 |     | 0.048<br>(0.106)   |
| Plastic holder              |                     | CR-MH          | 1SVR405659R1000 | 10  | 0.003<br>(0.007)   |
| Metal holder                |                     | CR-MH1         | 1SVR405659R1100 | 10  | 0.0005<br>(0.001)  |
| CR-MJ                       |                     | CR-MJ          | 1SVR405658R6000 | 10  | 0.029<br>(0.064)   |
| CR-M                        |                     | CR-MM          | 1SVR405658R1000 | 10  | 0.0005<br>(0.001)  |

# Pluggable interface relays

## Ordering details



CR-P/M ...

### Ordering details - CR-P/M range

| Rated control supply voltage | Description  | Version                | Reference code | Catalog number  | Pkg | Weight             |
|------------------------------|--|------------------------|----------------|-----------------|-----|--------------------|
|                              |  |                        |                |                 | qty | (1 pce)<br>kg (lb) |
| 6-230 V DC                   | Diode - Reverse polarity protection/ free wheeling diode         | A1+, A2-               | CR-P/M 22      | 1SVR405651R0000 | 10  | 0.003 (0.007)      |
| 6-24 V DC                    | Diode and LED - Reverse polarity protection/ free wheeling diode | red, A1+, A2-          | CR-P/M 42      | 1SVR405652R0000 | 10  | 0.003 (0.007)      |
| 24-60 V DC                   |  | green, A1+, A2-        | CR-P/M 42V     | 1SVR405652R1000 |     |                    |
| 24-60 V DC                   |  | red, A1+, A2-          | CR-P/M 42B     | 1SVR405652R4000 |     |                    |
| 110-230 V DC                 |  | green, A1+, A2-        | CR-P/M 42BV    | 1SVR405652R4100 |     |                    |
| 110-230 V DC                 | Diode and LED - Reverse polarity protection/ free wheeling diode | red, A1+, A2-          | CR-P/M 42C     | 1SVR405652R9000 | 10  | 0.003 (0.007)      |
| 110-230 V DC                 |  | green, A1+, A2-        | CR-P/M 42CV    | 1SVR405652R9100 |     |                    |
| 6-24 V AC                    | Spark quenching  |                        | CR-P/M 52B     | 1SVR405653R0000 | 10  | 0.003 (0.007)      |
| 24-60 V AC                   |  |                        | CR-P/M 52D     | 1SVR405653R4000 |     |                    |
| 110-230 V AC                 |  |                        | CR-P/M 52C     | 1SVR405653R1000 |     |                    |
| 6-24 V AC/DC                 | Diode and LED  | red, for DC A1+, A2-   | CR-P/M 62      | 1SVR405654R0000 | 10  | 0.003 (0.007)      |
| 6-24 V AC/DC                 |  | green, for DC A1+, A2- | CR-P/M 62V     | 1SVR405654R1000 |     |                    |
| 24-60 V AC/DC                |  | red, for DC A1+, A2-   | CR-P/M 62E     | 1SVR405654R4000 |     |                    |
| 24-60 V AC/DC                |  | green, for DC A1+, A2- | CR-P/M 62EV    | 1SVR405654R4100 |     |                    |
| 110-230 V AC/DC              | Diode and LED  | red, for DC A1+, A2-   | CR-P/M 92      | 1SVR405654R0100 | 10  | 0.003 (0.007)      |
| 110-230 V AC/DC              |  | green, for DC A1+, A2- | CR-P/M 92V     | 1SVR405654R1100 |     |                    |
| 6-24 V AC/DC                 | Varistor and LED Overvoltage protection                          | red, for DC A1+, A2-   | CR-P/M 62C     | 1SVR405655R0000 | 10  | 0.003 (0.007)      |
| 6-24 V AC/DC                 |  | green, for DC A1+, A2- | CR-P/M 62CV    | 1SVR405655R1000 |     |                    |
| 24-60 V AC/DC                |  | red, for DC A1+, A2-   | CR-P/M 62D     | 1SVR405655R4000 |     |                    |
| 24-60 V AC/DC                |  | green, for DC A1+, A2- | CR-P/M 62DV    | 1SVR405655R4100 |     |                    |
| 110-230 V AC/DC              | Varistor and LED Overvoltage protection                          | red, for DC A1+, A2-   | CR-P/M 92C     | 1SVR405655R0100 | 10  | 0.003 (0.007)      |
| 110-230 V AC/DC              |  | green, for DC A1+, A2- | CR-P/M 92CV    | 1SVR405655R1100 |     |                    |
| 24 V AC                      | Overvoltage protection   |                        | CR-P/M 72      | 1SVR405656R0000 | 10  | 0.002 (0.004)      |
| 115 V AC                     |  |                        | CR-P/M 72A     | 1SVR405656R1000 |     |                    |
| 230 V AC                     |  |                        | CR-P/M 82      | 1SVR405656R2000 |     |                    |

### Connection diagrams

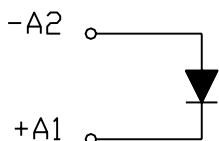

CR-P/M 22

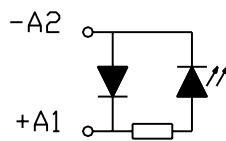

CR-P/M 42, P/M 42C, P/M 42BV, CR-P/M 42B, CR-P/M 42V, CR-P/M 42CV

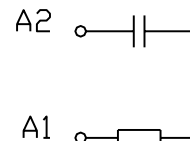

CR-P/M 52B, CR-P/M 52C

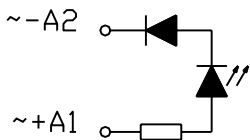

CR-P/M 62, P/M 92, P/M 62EV, CR-P/M 62E, CR-P/M 92V, CR-P/M 62V, CR-P/M 92V

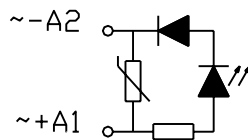

CR-P/M 62C, P/M 92C, P/M 62DV, CR-P/M 62D, CR-P/M 62CV, CR-P/M 92CV

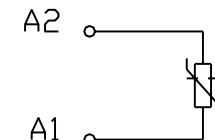

CR-P/M 72, CR-P/M 72A, CR-P/M 82

# Pluggable interface relays

## Ordering details

Interface relays  
CR Range



CR-U

### Description

Interface relays are widely used in various industrial applications:

As an interface they link the electronic controlling, e.g. PLC (programmable logic controller), PC or field bus systems, to the sensor / actuator level. Here, they take on various functions: Switching of AC or DC loads with different resistive, inductive and capacitive parts, switching voltages from a few mV up to 250 V, switching currents from a few mA up to 16 A, amplification of weak control signals, electrical isolation of control and load circuits, and signal multiplying. In contrast to electronic switching devices, interface relays don't use additional internal protective circuits and thus are overload-proof against short-time variations like current or voltage peaks.

6

### Ordering details - CR-U range

| Rated control supply voltage | Outputs              | Contact ratings | Reference code       | Catalog number  | Pkg qty | Weight (1 pce) kg (lb) |             |                 |    |                  |
|------------------------------|----------------------|-----------------|----------------------|-----------------|---------|------------------------|-------------|-----------------|----|------------------|
| 12 V DC                      | 2 c/o<br>without LED | 250 V, 10 A     | CR-U012DC2           | 1SVR405621R4000 | 10      | 0.083<br>(0.183)       |             |                 |    |                  |
| 24 V DC                      |                      |                 | CR-U024DC2           | 1SVR405621R1000 |         |                        |             |                 |    |                  |
| 48 V DC                      |                      |                 | CR-U048DC2           | 1SVR405621R6000 |         |                        |             |                 |    |                  |
| 110 V DC                     |                      |                 | CR-U110DC2           | 1SVR405621R8000 |         |                        |             |                 |    |                  |
| 220 V DC                     |                      |                 | CR-U220DC2           | 1SVR405621R9000 |         |                        |             |                 |    |                  |
| 24 V AC                      |                      |                 | CR-U024AC2           | 1SVR405621R0000 |         |                        |             |                 |    |                  |
| 48 V AC                      |                      |                 | CR-U048AC2           | 1SVR405621R5000 |         |                        |             |                 |    |                  |
| 110 V AC                     |                      |                 | CR-U110AC2           | 1SVR405621R7000 |         |                        |             |                 |    |                  |
| 120 V AC                     |                      |                 | CR-U120AC2           | 1SVR405621R2000 |         |                        |             |                 |    |                  |
| 230 V AC                     |                      |                 | CR-U230AC2           | 1SVR405621R3000 |         |                        |             |                 |    |                  |
| 12 V DC                      |                      |                 | 3 c/o<br>without LED | 250 V, 10 A     |         |                        | CR-U012DC3  | 1SVR405622R4000 | 10 | 0.083<br>(0.183) |
| 24 V DC                      |                      |                 |                      |                 |         |                        | CR-U024DC3  | 1SVR405622R1000 |    |                  |
| 48 V DC                      | CR-U048DC3           | 1SVR405622R6000 |                      |                 |         |                        |             |                 |    |                  |
| 110 V DC                     | CR-U110DC3           | 1SVR405622R8000 |                      |                 |         |                        |             |                 |    |                  |
| 125 V DC                     | CR-U125DC3           | 1SVR405622R8200 |                      |                 |         |                        |             |                 |    |                  |
| 220 V DC                     | CR-U220DC3           | 1SVR405622R9000 |                      |                 |         |                        |             |                 |    |                  |
| 24 V AC                      | CR-U024AC3           | 1SVR405622R0000 |                      |                 |         |                        |             |                 |    |                  |
| 48 V AC                      | CR-U048AC3           | 1SVR405622R5000 |                      |                 |         |                        |             |                 |    |                  |
| 60 V AC                      | CR-U060AC3           | 1SVR405622R5200 |                      |                 |         |                        |             |                 |    |                  |
| 110 V AC                     | CR-U110AC3           | 1SVR405622R7000 |                      |                 |         |                        |             |                 |    |                  |
| 120 V AC                     | CR-U120AC3           | 1SVR405622R2000 |                      |                 |         |                        |             |                 |    |                  |
| 230 V AC                     | CR-U230AC3           | 1SVR405622R3000 |                      |                 |         |                        |             |                 |    |                  |
| 12 V AC                      | 2 c/o<br>with LED    | 250 V, 10 A     | CR-U012DC2L          | 1SVR405621R4100 | 10      | 0.083<br>(0.183)       |             |                 |    |                  |
| 24 V DC                      |                      |                 | CR-U024DC2L          | 1SVR405621R1100 |         |                        |             |                 |    |                  |
| 48 V DC                      |                      |                 | CR-U048DC2L          | 1SVR405621R6100 |         |                        |             |                 |    |                  |
| 110 V DC                     |                      |                 | CR-U110DC2L          | 1SVR405621R8100 |         |                        |             |                 |    |                  |
| 220 V DC                     |                      |                 | CR-U220DC2L          | 1SVR405621R9100 |         |                        |             |                 |    |                  |
| 24 V AC                      |                      |                 | CR-U024AC2L          | 1SVR405621R0100 |         |                        |             |                 |    |                  |
| 48 V AC                      |                      |                 | CR-U048AC2L          | 1SVR405621R5100 |         |                        |             |                 |    |                  |
| 110 V AC                     |                      |                 | CR-U110AC2L          | 1SVR405621R7100 |         |                        |             |                 |    |                  |
| 120 V AC                     |                      |                 | CR-U120AC2L          | 1SVR405621R2100 |         |                        |             |                 |    |                  |
| 230 V AC                     |                      |                 | CR-U230AC2L          | 1SVR405621R3100 |         |                        |             |                 |    |                  |
| 12 V DC                      |                      |                 | 3 c/o<br>with LED    | 250 V, 10 A     |         |                        | CR-U012DC3L | 1SVR405622R4100 | 10 | 0.083<br>(0.183) |
| 24 V DC                      |                      |                 |                      |                 |         |                        | CR-U024DC3L | 1SVR405622R1100 |    |                  |
| 48 V DC                      | CR-U048DC3L          | 1SVR405622R6100 |                      |                 |         |                        |             |                 |    |                  |
| 110 V DC                     | CR-U110DC3L          | 1SVR405622R8100 |                      |                 |         |                        |             |                 |    |                  |
| 220 V DC                     | CR-U220DC3L          | 1SVR405622R9100 |                      |                 |         |                        |             |                 |    |                  |
| 24 V AC                      | CR-U024AC3L          | 1SVR405622R0100 |                      |                 |         |                        |             |                 |    |                  |
| 48 V AC                      | CR-U048AC3L          | 1SVR405622R5100 |                      |                 |         |                        |             |                 |    |                  |
| 110 V AC                     | CR-U110AC3L          | 1SVR405622R7100 |                      |                 |         |                        |             |                 |    |                  |
| 120 V AC                     | CR-U120AC3L          | 1SVR405622R2100 |                      |                 |         |                        |             |                 |    |                  |
| 230 V AC                     | CR-U230AC3L          | 1SVR405622R3100 |                      |                 |         |                        |             |                 |    |                  |

### Ordering details - Accessories



CR-U2S

| Version                     | Reference code | Catalog number  | Pkg qty | Weight (1 pce) kg (lb) |
|-----------------------------|----------------|-----------------|---------|------------------------|
| Socket for 2 c/o and module | CR-U2S         | 1SVR405670R0000 | 10      |                        |
| Socket for 3 c/o and module | CR-U3S         | 1SVR405660R0000 |         |                        |
| Socket for 3 c/o            | CR-U3E         | 1SVR405660R0100 |         |                        |
| Socket small for 2 c/o      | CR-U2SM        | 1SVR405670R1100 |         |                        |
| Socket small for 3 c/o      | CR-U3SM        | 1SVR405660R1100 |         |                        |
| Holder for CR-U socket      | CR-UH          | 1SVR405669R0000 |         |                        |

## Pluggable interface relays

### Ordering details



CR-U...

#### Ordering details - CR-U range

| Rated control supply voltage                     | Description   | Version  | Reference code                   | Catalog number  | Pkg             | Weight             |               |
|--|---|--|----------------------------------|---|-----------------|--------------------|---------------|
|  |   |  |                                  |   | qty             | (1 pce)<br>kg (lb) |               |
| 6-230 V DC                                       | Diode - Reverse polarity protection/free wheeling diode         | A1+, A2-                                       | CR-U 21                          | 1SVR405661R0000                                       | 10              | 0.007 (0.015)      |               |
| 6-24 V DC  | Diode and LED - Reverse polarity protection/free wheeling diode | red, A1+, A2-<br>green, A1+, A2-               | CR-U 41                          | 1SVR405662R0000                                       | 10              | 0.007 (0.015)      |               |
| 24-60 V DC                                       |   | red, A1+, A2-<br>green, A1+, A2-               | CR-U 41B                         | 1SVR405662R4000                                       |                 |                    |               |
| 110-230 V DC                                     |   | red, A1+, A2-<br>green, A1+, A2-               | CR-U 41C                         | 1SVR405662R9000                                       |                 |                    |               |
|  |   | red, A1+, A2-<br>green, A1+, A2-               | CR-U 41CV                        | 1SVR405662R9100                                       |                 |                    |               |
| 6-24 V AC<br>24-60 V AC<br>110-230 V AC          | Spark quenching   |  | CR-U 51B<br>CR-U 51D<br>CR-U 51C | 1SVR405663R0000<br>1SVR405663R4000<br>1SVR405663R1000 | 10              | 0.007 (0.015)      |               |
| 6-24 V AC/DC<br>24-60 V AC/DC<br>110-230 V AC/DC | Diode and LED   | red, for DC A1+, A2-<br>green, for DC A1+, A2- | CR-U 61                          | 1SVR405664R0000                                       | 10              | 0.007 (0.015)      |               |
| 24-60 V AC/DC                                    |   | red, for DC A1+, A2-<br>green, for DC A1+, A2- | CR-U 61V                         | 1SVR405664R1000                                       |                 |                    |               |
|  |   | red, for DC A1+, A2-<br>green, for DC A1+, A2- | CR-U 61E                         | 1SVR405664R4000                                       |                 |                    |               |
| 110-230 V AC/DC                                  |   | red, for DC A1+, A2-<br>green, for DC A1+, A2- | CR-U 91                          | 1SVR405664R0100                                       |                 |                    |               |
| 6-24 V AC/DC<br>24-60 V AC/DC<br>110-230 V AC/DC | Varistor and LED Overvoltage protection                         | red, for DC A1+, A2-<br>green, for DC A1+, A2- | CR-U 61C                         | 1SVR405665R0000                                       | 10              | 0.007 (0.015)      |               |
|  |   | red, for DC A1+, A2-<br>green, for DC A1+, A2- | CR-U 61CV                        | 1SVR405665R1000                                       |                 |                    |               |
|  |   | red, for DC A1+, A2-<br>green, for DC A1+, A2- | CR-U 61D                         | 1SVR405665R4000                                       |                 |                    |               |
|  |   | red, for DC A1+, A2-<br>green, for DC A1+, A2- | CR-U 61DV                        | 1SVR405665R4100                                       |                 |                    |               |
| 24 V AC<br>115 V AC<br>230 V AC                  | Overvoltage protection  |  | CR-U 71<br>CR-U 71A<br>CR-U 81   | 1SVR405666R0000<br>1SVR405666R1000<br>1SVR405666R2000 | 10              | 0.007 (0.015)      |               |
| 24-240 V AC/DC                                   |   | Multifunction time module                      | pluggable onto CR-U2S and CR-U3S | CR-U T  | 1SVR405667R0000 | 10                 | 0.014 (0.031) |



CR-U T

#### Connection diagrams

All CR-U modules can be plugged onto sockets CR-U2S and CR-U3S.

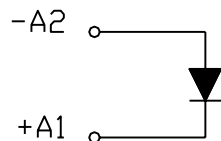

CR-U 21

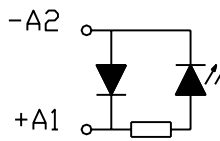

CR-U 41, CR-U 41B, CR-U 41C, CR-U 41V, CR-U 41V, CR-U 41BV, CR-U 41CV

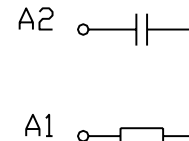

CR-U 51B, CR-U 51C CR-U 51D,

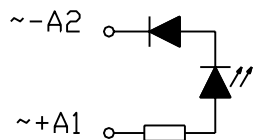

CR-U 61, CR-U 61E, CR-U 91, CR-U 61V, CR-U 61EV, CR-U 91V

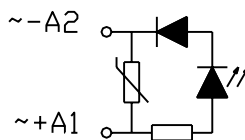

CR-U 61C, CR-U 61D, CR-U 91C, CR-U 61CV, CR-U 61DV CR-U 91CV

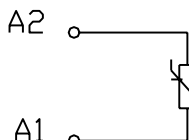

CR-U 71, CR-U 81 CR-U 71A,

# Pluggable interface relays

## Technical data

Interface relays  
CR Range

6

### Input circuit - coil data

#### CR-P range

|  | Rated control supply voltage $U_s$ | Rated frequency | Make voltage (at 20 °C) | Maximum voltage (at 55 °C) | Break voltage | Rated power | Coil resistance (at 20 °C) | Tolerance of coil resistance |
|---|------------------------------------|-----------------|-------------------------|----------------------------|---------------|-------------|----------------------------|------------------------------|
| DC coils  | 12 V DC                            | -               | 8.4 V DC                | 30.6 V DC                  | M 0.1 $U_s$   | 0.4-0.48 W  | 360 q                      | w 10%                        |
|   | 24 V DC                            | -               | 16.8 V DC               | 61.2 V DC                  | M 0.1 $U_s$   | 0.4-0.48 W  | 1440 q                     | w 10%                        |
|   | 48 V DC                            | -               | 33.6 V DC               | 122.4 V DC                 | M 0.1 $U_s$   | 0.4-0.48 W  | 5700 q                     | w 10%                        |
|   | 110 V DC                           | -               | 77 V DC                 | 280 V DC                   | M 0.1 $U_s$   | 0.4-0.48 W  | 25200 q                    | w 10%                        |
| AC coils  | 24 V AC                            | 50 / 60 Hz      | 19.2 V AC               | 28.8 V AC                  | M 0.15 $U_s$  | 0.75 VA     | 400 q                      | w 10%                        |
|   | 48 V AC                            | 50 / 60 Hz      | 38.4 V AC               | 57.6 V AC                  | M 0.15 $U_s$  | 0.75 VA     | 1550 q                     | w 10%                        |
|   | 110 V AC                           | 50 / 60 Hz      | 88 V AC                 | 132 V AC                   | M 0.15 $U_s$  | 0.75 VA     | 8900 q                     | w 10%                        |
|   | 120 V AC                           | 50 / 60 Hz      | 96 V AC                 | 144 V AC                   | M 0.15 $U_s$  | 0.75 VA     | 10200 q                    | w 10%                        |
|   | 230 V AC                           | 50 / 60 Hz      | 184 V AC                | 276 V AC                   | M 0.15 $U_s$  | 0.75 VA     | 38500 q                    | w 10%                        |

#### CR-M range

|  | Rated control supply voltage $U_s$ | Rated frequency | Make voltage (at 20 °C) | Maximum voltage (at 55 °C) | Break voltage | Rated power | Coil resistance (at 20 °C) | Tolerance of coil resistance |
|---|------------------------------------|-----------------|-------------------------|----------------------------|---------------|-------------|----------------------------|------------------------------|
| DC coils  | 12 V DC                            | -               | 9.6 V DC                | 13.2 V DC                  | M 0.1 $U_s$   | 0.9 W       | 160 q                      | w 10%                        |
|   | 24 V DC                            | -               | 19.2 DC                 | 26.4 V DC                  | M 0.1 $U_s$   | 0.9 W       | 640 q                      | w 10%                        |
|   | 48 V DC                            | -               | 38.4 V DC               | 52.8 V DC                  | M 0.1 $U_s$   | 0.9 W       | 2600 q                     | w 10%                        |
|   | 60 V DC                            | -               | 48.0 V DC               | 66.0 V DC                  | M 0.1 $U_s$   | 0.9 W       | 4000 q                     | w 10%                        |
|   | 110 V DC                           | -               | 88 V DC                 | 121 V DC                   | M 0.1 $U_s$   | 0.9 W       | 13600 q                    | w 10%                        |
|   | 125 V DC                           | -               | 100 V DC                | 137,5 V DC                 | M 0.1 $U_s$   | 0.9 W       | 16000 q                    | w 10%                        |
|   | 220 V DC                           | -               | 176 V DC                | 242 V DC                   | M 0.1 $U_s$   | 0.9 W       | 54000 q                    | w 10%                        |
| AC coils  | 24 V AC                            | 50 / 60 Hz      | 19.2 V AC               | 26.4 V AC                  | M 0.2 $U_s$   | 1.6 VA      | 158 q                      | w 10%                        |
|   | 48 V AC                            | 50 / 60 Hz      | 38.4 V AC               | 52.8 V AC                  | M 0.2 $U_s$   | 1.6 VA      | 640 q                      | w 10%                        |
|   | 60 V AC                            | 50 / 60 Hz      | 48.0 V AC               | 66.0 V AC                  | M 0.2 $U_s$   | 1.6 VA      | 930 q                      | w 10%                        |
|   | 110 V AC                           | 50 / 60 Hz      | 88 V AC                 | 121 V AC                   | M 0.2 $U_s$   | 1.6 VA      | 3450 q                     | w 10%                        |
|   | 120 V AC                           | 50 / 60 Hz      | 96 V AC                 | 132 V AC                   | M 0.2 $U_s$   | 1.6 VA      | 3770 q                     | w 10%                        |
|   | 230 V AC                           | 50 / 60 Hz      | 184 V AC                | 253 V AC                   | M 0.2 $U_s$   | 1.6 VA      | 16100 q                    | w 10%                        |

#### CR-U range

|  | Rated control supply voltage $U_s$ | Rated frequency | Make voltage (at 20 °C) | Maximum voltage (at 55 °C) | Break voltage | Rated power                      | Coil resistance (at 20 °C)       | Tolerance of coil resistance |
|---|------------------------------------|-----------------|-------------------------|----------------------------|---------------|----------------------------------|----------------------------------|------------------------------|
| DC coils  | 12 V DC                            | -               | 9.6 V DC                | 13.2 V DC                  | M 0.1 $U_s$   | 1.5 W                            | 110 q                            | w 10%                        |
|   | 24 V DC                            | -               | 19.2 V DC               | 26.4 V DC                  | M 0.1 $U_s$   | 1.5 W                            | 430 q                            | w 10%                        |
|   | 48 V DC                            | -               | 38.4 V DC               | 52.8 V DC                  | M 0.1 $U_s$   | 1.5 W                            | 1750 q                           | w 10%                        |
|   | 110 V DC                           | -               | 88.0 V DC               | 121.0 V DC                 | M 0.1 $U_s$   | 1.5 W                            | 9200 q                           | w 10%                        |
|   | 125 V DC                           | -               | 96.0 V DC               | 132.0 V DC                 | M 0.1 $U_s$   | 1.5 W                            | 11000 q                          | w 10%                        |
|   | 220 V DC                           | -               | 176.0 V DC              | 242.0 V DC                 | M 0.1 $U_s$   | 1.5 W                            | 37000 q                          | w 10%                        |
|   | AC coils                           | 24 V AC         | 50 / 60 Hz              | 19.2 V AC                  | 26.4 V AC     | M 0.15 $U_s$                     | 2.8 VA (50 Hz)<br>2.5 VA (60 Hz) | 75 q                         |
| 48 V AC   |                                    | 50 / 60 Hz      | 38.4 V AC               | 52.8 V AC                  | M 0.15 $U_s$  | 2.8 VA (50 Hz)<br>2.5 VA (60 Hz) | 305 q                            | w 10%                        |
| 60 V AC   |                                    | 50 / 60 Hz      | 48.0 V AC               | 66.0 V AC                  | M 0.15 $U_s$  | 2.8 VA (50 Hz)<br>2.5 VA (60 Hz) | 475 q                            | w 10%                        |
| 110 V AC  |                                    | 50 / 60 Hz      | 88.0 V AC               | 121.0 V AC                 | M 0.15 $U_s$  | 2.8 VA (50 Hz)<br>2.5 VA (60 Hz) | 1700 q                           | w 10%                        |
| 120 V AC  |                                    | 50 / 60 Hz      | 96.0 V AC               | 132.0 V AC                 | M 0.15 $U_s$  | 2.8 VA (50 Hz)<br>2.5 VA (60 Hz) | 1910 q                           | w 10%                        |
| 230 V AC  |                                    | 50 / 60 Hz      | 184.0 V AC              | 253.0 V AC                 | M 0.15 $U_s$  | 2.8 VA (50 Hz)<br>2.5 VA (60 Hz) | 7080 q                           | w 10%                        |

# Pluggable interface relays

## Technical data

6

| Type   | CR-P...1  | CR-P...2                           | CR-M...2                                     | CR-M...3                               | CR-M...4                                     | CR-U...2                        | CR-U...3                           |
|--|---|------------------------------------|--|--|--|---------------------------------|------------------------------------|
| Output circuit(s)  | 11-12/14  | 11-12/14<br>21-22/24               | 11-12/14<br>21-22/24                         | 11-12/14<br>21-22/24<br>31-32/34       | 11-12/14<br>21-22/24<br>31-32/34<br>41-42/44 | 11-12/14<br>31-32/34            | 11-12/14<br>21-22/24<br>31-32/34   |
| Kind of output   | Relay, 1 c/o  | Relay, 2 c/o                       | Relay, 2 c/o                                 | Relay, 3 c/o                           | Relay, 4 c/o                                 | Relay, 2 c/o                    | Relay, 3 c/o                       |
| Contact material   | AgNi  | AgNi<br>AgNi/Au 5 µm               | AgNi   | AgNi                                   | AgNi<br>AgNi/Au 5 µm                         | AgNi                            |                                    |
| Rated operational voltage U <sub>e</sub> (VDE 0110, IEC 60947-1) |   |                                    |  | 250 V                                  |  |                                 |                                    |
| Minimum switching voltage  |   |                                    |  | 5 V                                    |  |                                 |                                    |
| Maximum switching voltage  | DC  | 300 V DC                           |  | 250 V DC                               |  |                                 |                                    |
|  | AC  | 400 V AC                           |  | 250 V AC                               |  |                                 |                                    |
| Minimum switching current  | 5 mA (AgNi), 2 mA (AgNi/Au)                         |                                    |  |  |  |                                 |                                    |
| Rated free air thermal current I <sub>th</sub>                   | 16 A  | 8 A                                | 12 A   | 10 A                                   | 6 A  | 10 A                            |                                    |
| Rated operational current (IEC 60947-5-1)                        | AC12 (resistive) 230 V                              | 16 A                               | 8 A  | 12 A                                   | 10 A   | 6 A                             | 10 A                               |
|  | AC15 (inductive) 230 V                              | 1.5 A                              | 1 A  | 1.5 A                                  | 1.5 A  | 1 A                             | 1.5 A                              |
|  | DC12 (resistive) 24 V                               | 16 A                               | 8 A  | 12 A                                   | 10 A   | 6 A                             | 10 A                               |
|  | DC13 (inductive) 24 V                               | 2 A                                | 2 A  | 8 A                                    | 8 A  | 6 A                             | 2 A                                |
| AC rating (UL 508)   | Utilization category (Control Circuit Rating Code)  |                                    |  |  |  | -                               | B 300                              |
|  | max. rated operational voltage                      |                                    |  |  |  | -                               | 300 V AC                           |
|  | max. continuous thermal current at B 300            |                                    |  |  |  | -                               | 5 A                                |
|  | max. making / breaking apparent power at B 300      |                                    |  |  |  | -                               | 3600/360 VA                        |
|  | Utilization category General Purpose (single phase) |                                    |  |  |  | -                               | 10 A, 250 V AC                     |
|  | Utilization category (Resistive)                    | 16 A, 250 V AC                     | 8 A, 250 V AC                                | 10 A, 250 V AC<br>12 A, 150 V AC       | 6 A, 250 V AC<br>10 A, 150 V AC              | 6 A, 250 V AC<br>10 A, 150 V AC | 10 A, 250 V AC                     |
| Minimum switching power  | 0.3 W (AgNi), 0.1 W (AgNi/Au)                       |                                    |  |  |  |                                 | 0.3 W                              |
| Maximum switching power  | AC-1  | 4000 VA                            | 2000 VA                                      | 3000 VA                                | 2500 VA                                      | 1500 VA                         | 2500 VA                            |
| Contact resistance   | ≤ 100 mΩ  |                                    |  | ≤ 100 mΩ                               |  |                                 |                                    |
| Maximum switching capacity                                       | rated load AC-1                                     | 600 switching cycles/h             |  | 1200 switching cycles/h                |  |                                 |                                    |
|  | without load  | 72000 switching cycles/h           |  | 18000 switching cycles/h               |  |                                 | 12000 switching cycles/h           |
| Mechanical lifetime  | > 3 × 10 <sup>7</sup> switching cycles              |                                    |  | > 2 × 10 <sup>7</sup> switching cycles |  |                                 |                                    |
| Electrical lifetime  | AC1 (resistive)                                     | > 10 <sup>5</sup> switching cycles |  | > 10 <sup>5</sup> switching cycles     |  |                                 | > 10 <sup>5</sup> switching cycles |
|  |   | (16 A, 250 V)   (8 A, 250 V)       | (12 A, 250 V)   (10 A, 250 V)   (6 A, 250 V) | (10 A, 250 V)   (6 A, 250 V)           | (10 A, 250 V)                                |                                 |                                    |
|  | cos φ   | see reduction factor F             |  |  |  |                                 |                                    |
| Response time  | typ. 7 ms   |                                    | typ. 13 ms (DC), 10 ms (AC)                  |  |  | typ. 18 ms (DC), 12 ms (AC)     |                                    |
| Release time   | typ. 3 ms   |                                    | typ. 3 ms (DC), 8 ms (AC)                    |  |  | typ. 7 ms (DC), 10 ms (AC)      |                                    |
| <b>Isolation data</b>  |   |                                    |  |  |  |                                 |                                    |
| Rated insulation voltage   | 400 V AC  |                                    |  | 250 V AC                               |  |                                 |                                    |
| Insulation class   | C250 / B400   |                                    |  | C250 / B250                            |  | C250                            |                                    |
| Rated impulse withstand voltage U <sub>imp</sub>                 | between coil and contacts                           | 5 kV AC                            |  |  | 2.5 kV AC                                    |                                 |                                    |
|  | between open contacts                               | 1 kV AC                            |  |  | 1.5 kV AC                                    |                                 |                                    |
|  | between c/o contacts                                | 2.5 kV AC                          |  | 2.5 kV AC                              | 2 kV AC                                      | 2 kV AC                         |                                    |
| Clearance  | between coil and contacts                           | ≥ 10 mm                            |  | ≥ 2.5 mm                               | ≥ 1.6 mm                                     | ≥ 3 mm                          |                                    |
| Creepage distance  | between coil and contacts                           | ≥ 10 mm                            |  | ≥ 4 mm                                 | ≥ 3.2 mm                                     | ≥ 4.2 mm                        |                                    |
| Overvoltage category   | III   |                                    |  | III                                    | II   | III                             |                                    |
| Pollution degree   | 3   |                                    |  | 3                                      | 2  | 3                               |                                    |
| <b>General data</b>  |   |                                    |  |  |  |                                 |                                    |
| Dimensions (W x H x D) when mounted                              | 12.7 x 29 x 15.7 mm                                 |                                    |  | 21.2 x 27.5 x 35.6 mm                  |  | 35 x 35 x 54.4 mm               |                                    |
| Weight   | 14 g (0.031 lb)                                     |                                    |  | 35 g (0.077 lb)                        |  | 83 g (0.18 lb)                  |                                    |
| Mounting   | on socket (see accessories)                         |                                    |  |  |  |                                 |                                    |
| Mounting position  | any   |                                    |  |  |  |                                 |                                    |
| Degree of protection   | IP 67   |                                    |  | IP 40                                  |  |                                 |                                    |
| <b>Electrical connection</b>                                     |   |                                    |  |  |  |                                 |                                    |
| Connection   | by socket   |                                    |  |  |  |                                 |                                    |



# Pluggable interface relays

## Technical data, load limit curves

| Type                           |              | CR-P...1                               | CR-P...2 | CR-M...2                               | CR-M...3       | CR-M...4 | CR-U...2      | CR-U...3 |
|--------------------------------|--------------|--|----------|--|----------------|----------|---------------|----------|
| <b>Environmental data</b>      |              |  |          |  |                |          |               |          |
| Ambient temperature range      | operation DC | -40 ... +85 °C                         |          |  | -40 ... +70 °C |          |               |          |
|                                | operation AC | -40 ... +70 °C                         |          |  | -40 ... +55 °C |          |               |          |
|                                | storage      | -40 ... +85 °C                         |          |  |                |          |               |          |
| Vibration resistance 10-150 Hz | n/o contact  | 10 g                                   |          |  | 5 g            |          | 5 g           |          |
|                                | n/c contact  | 10 g                                   | 5 g      |  | 5 g            |          | 5 g           |          |
| Shock resistance               | n/o contact  | 30 g                                   | 20 g     |  | 10 g           |          | 10 g          |          |
|                                | n/c contact  | 30 g                                   | 20 g     |  | 5 g            |          | 10 g          |          |
| <b>Standards</b>               |              |  |          |  |                |          |               |          |
| Product standard               |              | EN 61810-1, EN 60255-23<br>IEC 60664-1 |          | EN 60810-1, EN 60255-23<br>IEC 61810-7 |                |          | EN 60255-1-00 |          |
| Low Voltage Directive          |              | 73/23/EEC                              |          |  |                |          |               |          |

### Load limit curves - Maximum switching power at resistive DC load

CR-P with 1 c/o contact

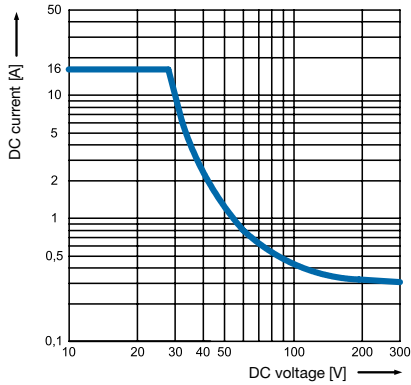

CR-P with 2 c/o contacts

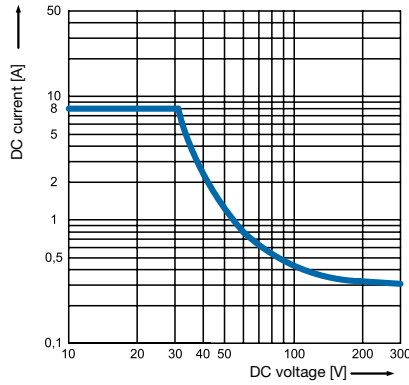

CR-U with 2 and 3 c/o contacts

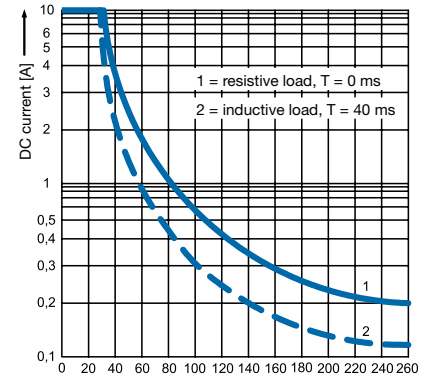

CR-M with 2 c/o contacts

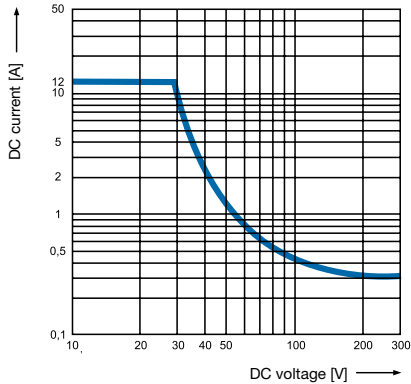

CR-M with 3 c/o contacts

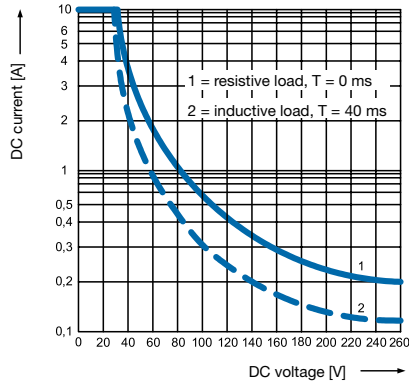

CR-M with 4 c/o contacts

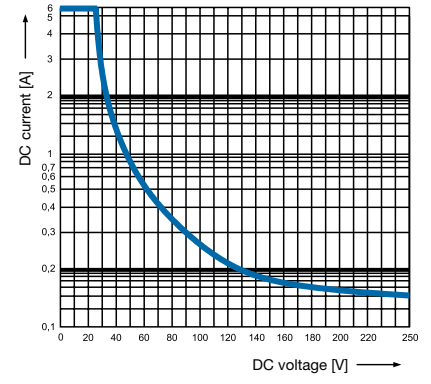

# Pluggable interface relays

## Load limit curves

### Load limit curves - Electrical lifetime at resistive AC load

6

CR-P with 1 c/o contact

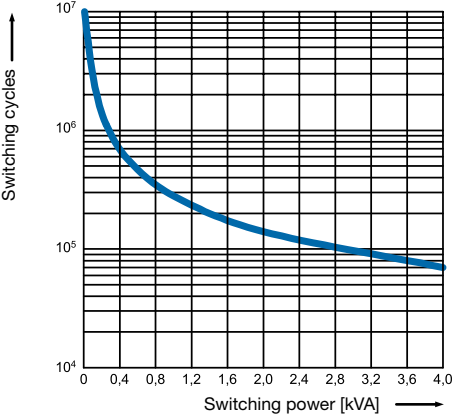

CR-P with 2 c/o contacts

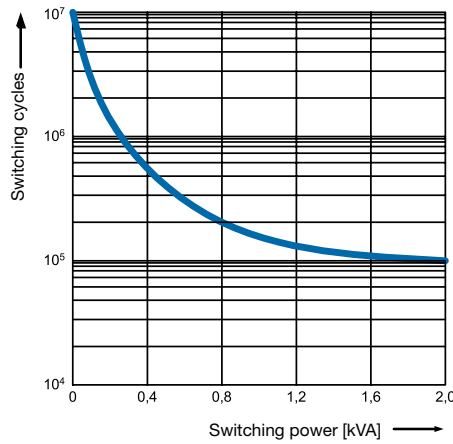

CR-U with 2 and 3 c/o contacts

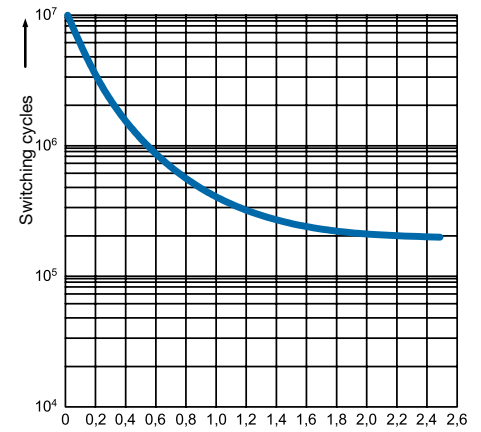

CR-M with 2 c/o contacts

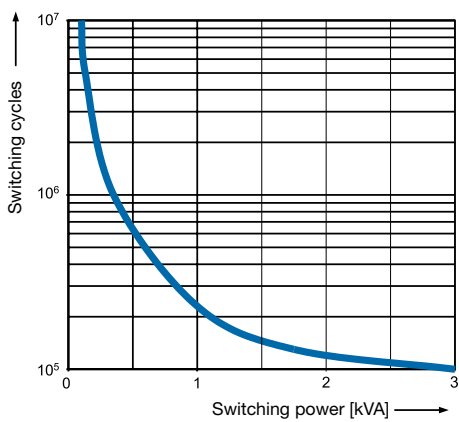

CR-M with 3 c/o contacts

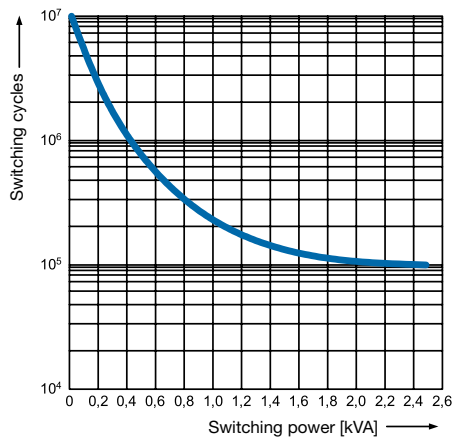

CR-M with 4 c/o contacts

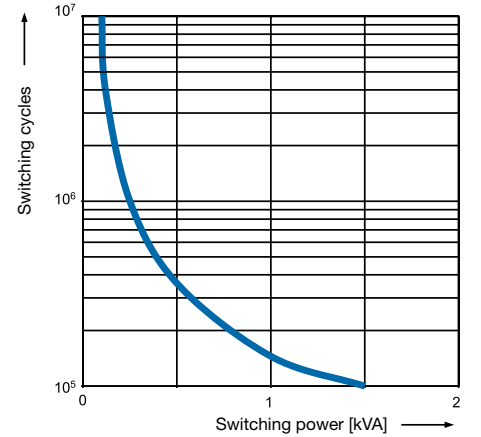

### Reduction factor F at inductive AC load

CR-P

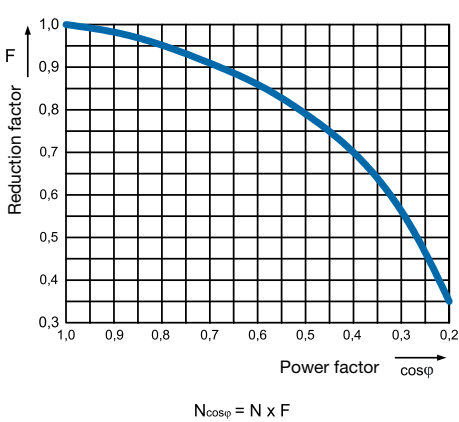

CR-M

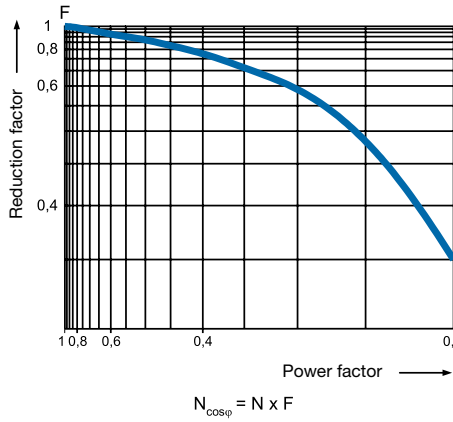

CR-U

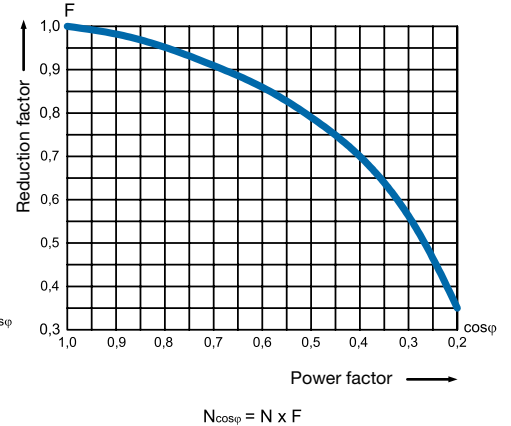

# Pluggable interface relays

## Connection diagrams

Interface relays  
CR Range

### Connection diagrams

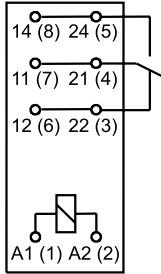

CR-P with 1 c/o contact

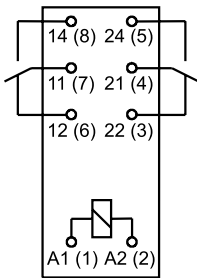

CR-P with 2 c/o contacts

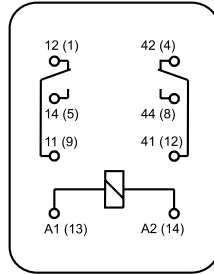

CR-M with 2 c/o contacts

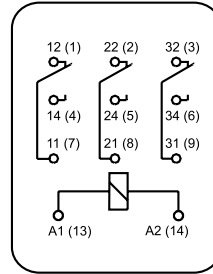

CR-M with 3 c/o contacts

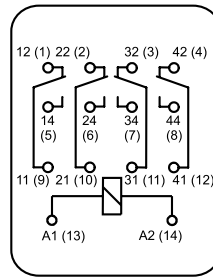

CR-M with 4 c/o contacts

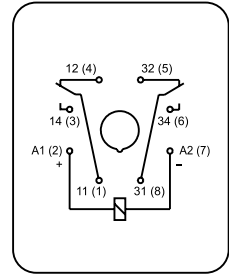

CR-U with 2 c/o contacts

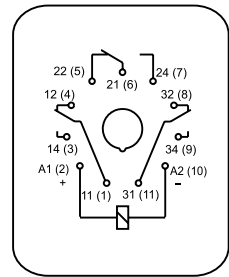

CR-U with 3 c/o contacts

### Dimensional drawings

### Dimensions in mm

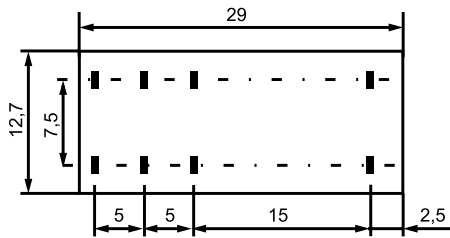

CR-P

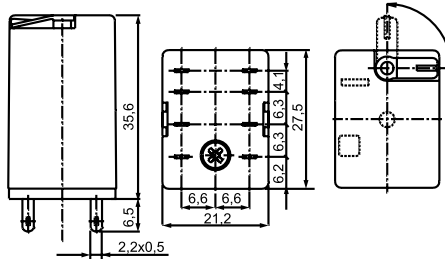

CR-M with 2 c/o contacts

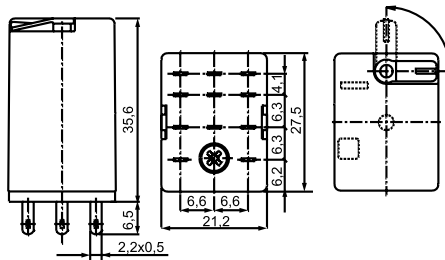

CR-M with 3 c/o contacts

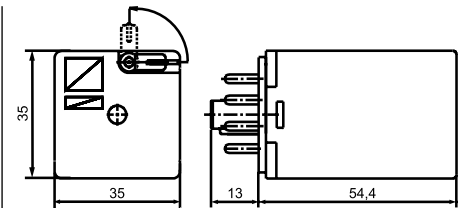
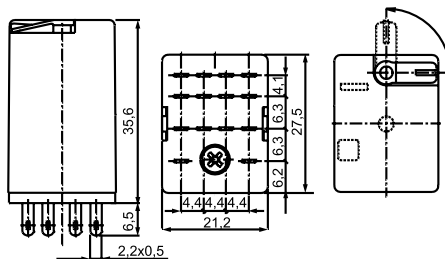

CR-U with 2 c/o contacts

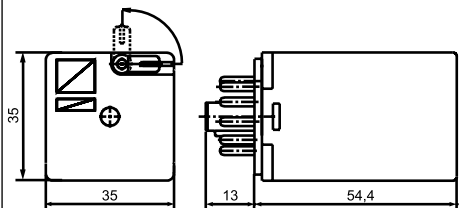

CR-U with 3 c/o contacts

# Pluggable interface relays

Approximate dimensions

Dimensional drawings

Sockets for screw connection

6

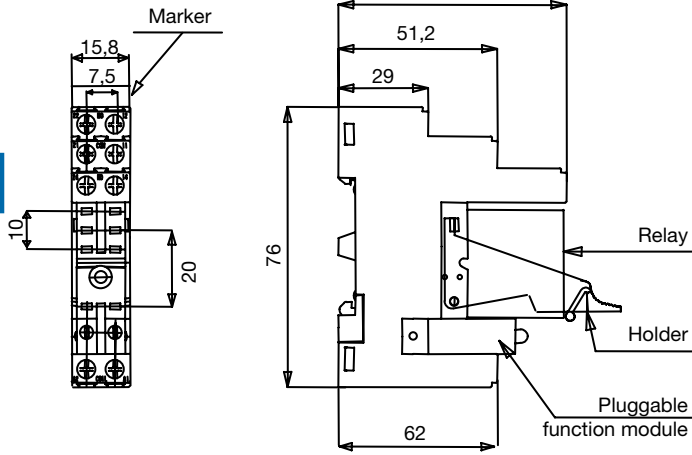

CR-PLS

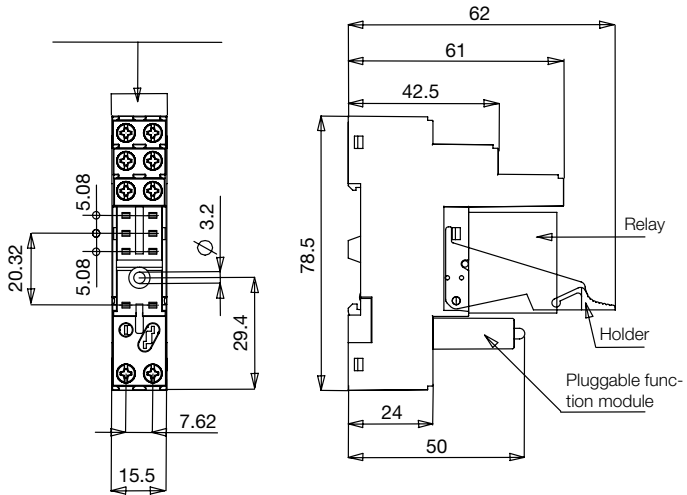

CR-PLSx

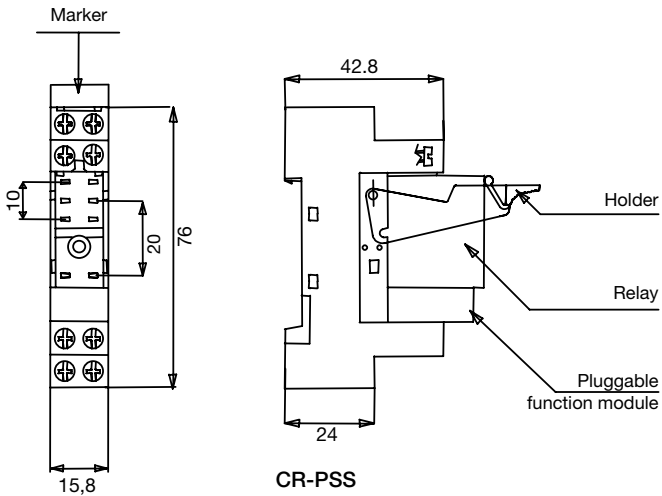

CR-PSS

Dimensions in mm

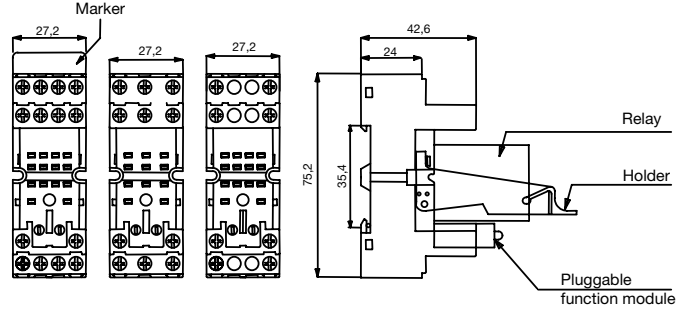

CR-M2SS - CR-M3SS - CR-M4SS

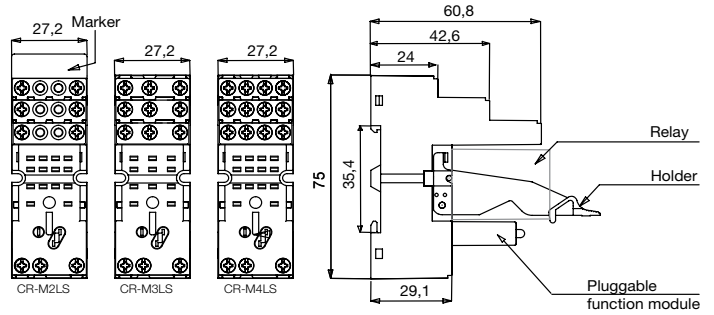

CR-M2LS - CR-M3LS - CR-M4LS

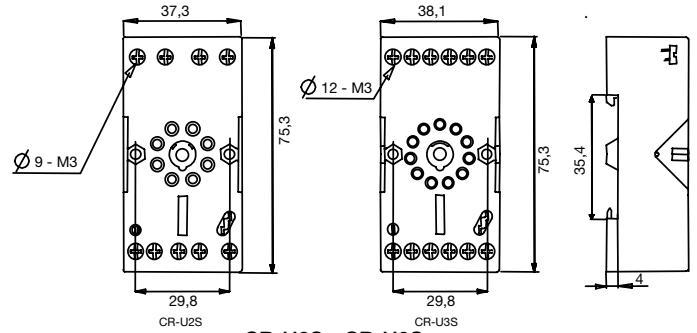

CR-U2S - CR-U3S

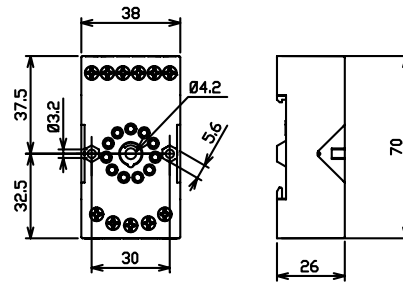

CR-U3E

# Pluggable interface relays

## Approximate dimensions

Interface relays  
CR Range

### Dimensional drawings

Dimensions in mm

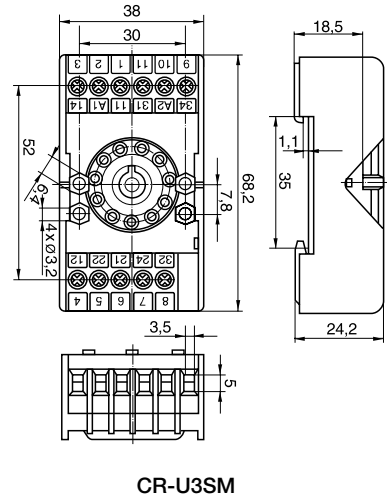
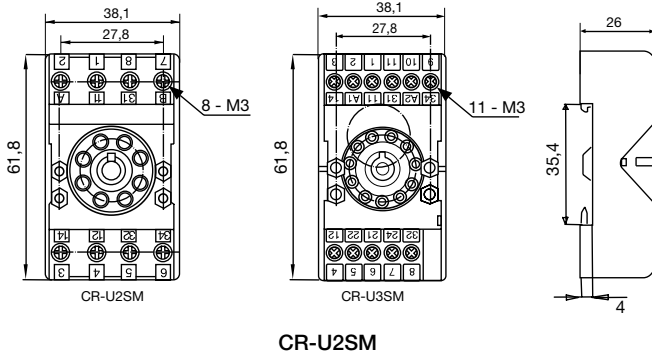

### Sockets for spring connection

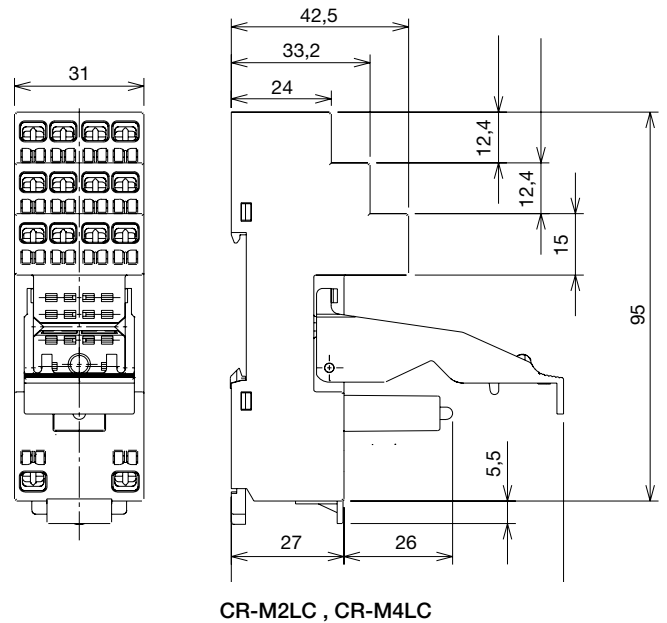
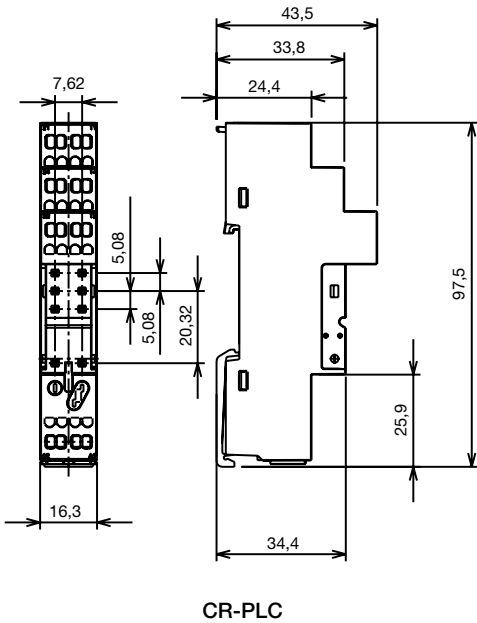

### Jumper

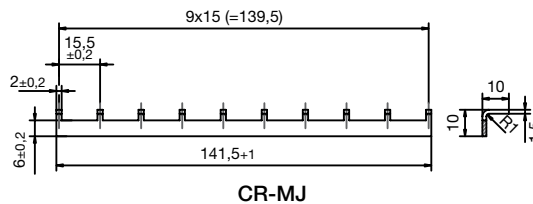
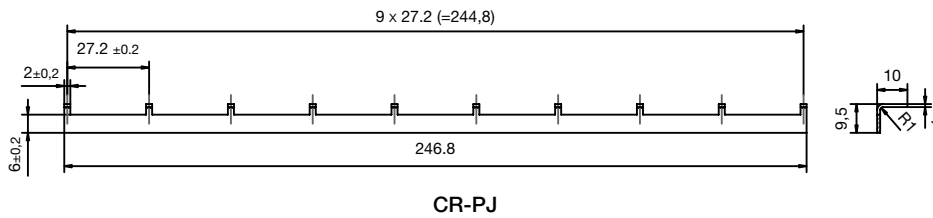

# Notes



Interface relays  
R600, R500

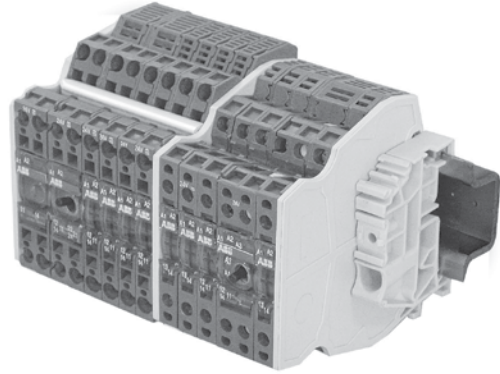

# R600 & R500 Interface relays

## Interface relays, R600, R500

### Benefits and advantages

6



R600 series

Standard range in screw clamp or spring clamp versions

- Spacing : 6 mm
- Wire size : 2.5 mm<sup>2</sup> (4 mm<sup>2</sup> solid wire)
- Contact type : 1 NO, 1 NC, 1 SPDT, 1 DPDT from 1 mA to 8 A / 250 V
- Transistor : 100 mA  
MOS : 1 A to 5 A  
Triac : 1 A to 2 A

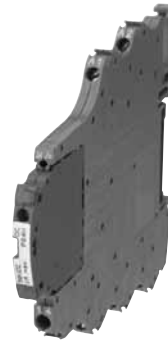

R500 series

Standard range with pluggable functions

- Spacing : 5.08 mm (the smallest in the market)
- Wire size : 2.5 mm<sup>2</sup> (4 mm<sup>2</sup> solid)
- Contact type : 1 SPDT from 10 mA to 6 A / 250 V
- Transistor : 30 mA to 100 mA  
MOS : 1 A to 2 A  
Triac : 1 A

In today's automation systems, PLCs are the core of industry. They link sensors and actuators to the process, which are connected to the PLC via conventional wires.

However these PLCs are not completely isolated from the industrial environment, hence voltage spikes and transient currents can affect their operating functions. And additionally, their application range is often limited to 24 VDC / 100 mA.

So, with the aim to adapt application voltage and/or current and provide as well the appropriate galvanic isolation to the PLC, it is recommended to install the correct interface to provide both voltage-current level adaptation and isolation protection.



This interfacing is possible thanks to ABB's relays and optocouplers ranges, which offer wide adaptation in both voltage (from 5 to 400 V) and current (from 10-7 to 16 A) as well as high isolation between input and output from 2 to 4 KV.



# Interface relays, R600, R500

## Type designators

Interface relays  
R600 & R500 Range

| SERIES  | CODE  | NB OF RELAYS             | CONTACT TYPE             | NB OF CONTACTS PER RELAY | PARTICULARITIES          |                          |                          |                          |
|---|---|--------------------------|--------------------------|--------------------------|--------------------------|--------------------------|--------------------------|--------------------------|
| R 600  | <table border="1"><tr><td>R</td><td>B</td></tr></table>               | R                        | B                        | <input type="checkbox"/> | <input type="checkbox"/> | <input type="checkbox"/> | <input type="checkbox"/> |                          |
| R   | B   |                          |                          |                          |                          |                          |                          |                          |
| R 600  | <table border="1"><tr><td>R</td><td>B</td><td>R</td></tr></table>     | R                        | B                        | R                        | <input type="checkbox"/> | <input type="checkbox"/> | <input type="checkbox"/> | <input type="checkbox"/> |
| R   | B   | R                        |                          |                          |                          |                          |                          |                          |
| R 500   | <table border="1"><tr><td>D</td><td>2,5/5</td><td>R</td></tr></table> | D                        | 2,5/5                    | R                        | <input type="checkbox"/> | <input type="checkbox"/> | <input type="checkbox"/> | <input type="checkbox"/> |
| D   | 2,5/5   | R                        |                          |                          |                          |                          |                          |                          |
|   |   | <input type="checkbox"/> | <input type="checkbox"/> | <input type="checkbox"/> | <input type="checkbox"/> |                          |                          |                          |
|   |   | ↓                        | ↓                        | ↓                        | ↓                        |                          |                          |                          |
|   |   | 1                        | 0                        | 1                        | None                     |                          |                          |                          |
|   |   | 2                        | 1                        | 2                        | A                        |                          |                          |                          |
|   |   |                          | 2                        |                          | B                        |                          |                          |                          |
|   |   |                          | 3                        |                          | C                        |                          |                          |                          |
|   |   |                          |                          |                          | N                        |                          |                          |                          |
|   |   |                          |                          |                          | P                        |                          |                          |                          |
|   |   |                          |                          |                          | R                        |                          |                          |                          |
|   |   |                          |                          |                          | V                        |                          |                          |                          |
|   |   |                          |                          |                          | I                        |                          |                          |                          |

### Description of contact types

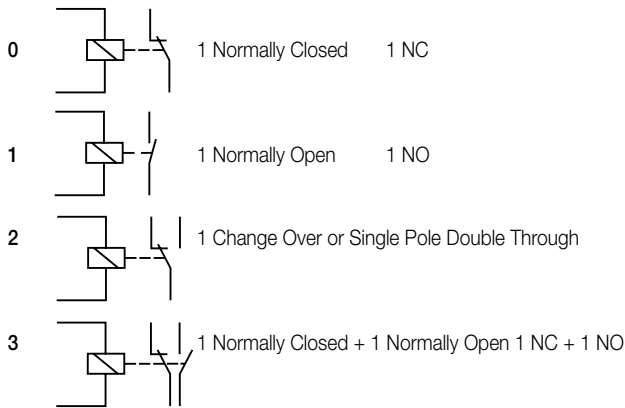

### Features

- None Input voltage DC
- A Input voltage AC/DC
- B Input voltage AC
- C 2 wire sensor compatibility

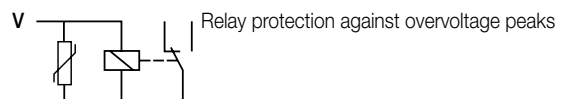
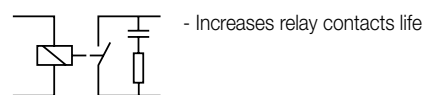
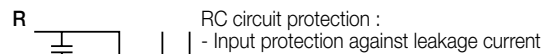
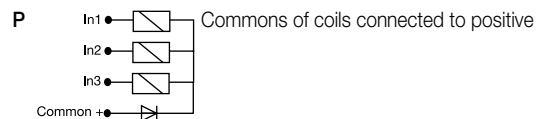
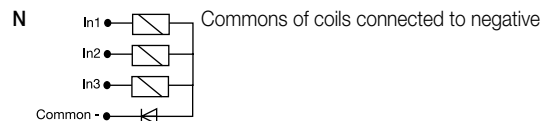
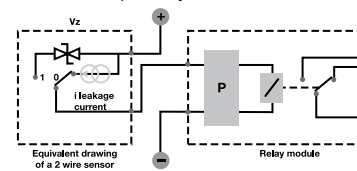

**I** Switch to force the coil for maintenance and/or installation purposes

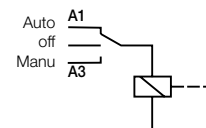

### Color coding for relays

| Color | Current level in contacts | Switching current       | Switching voltage         | Switching load power                                       |
|-------|---------------------------|-------------------------|---------------------------|--|
| green | Very low level            | 10 <sup>-7</sup> to 5 A | 10 <sup>-3</sup> to 250 V | 10 <sup>-10</sup> to 2000 VA<br>10 <sup>-10</sup> to 200 W |
| grey  | Low level                 | 1 mA to 8 A             | 5 to 250 V                | 0,05 to 1500 VA<br>0,05 to 192 W                           |
| blue  | High level                | 10 mA to 16 A           | 12 to 380 V               | 0,6 to 4000 VA<br>0,6 to 240 W                             |

## Interface relays, R600 Selection

6

|  | Reference code     | Catalog number   |
|--|--------------------|------------------|
|  | RB 121-5VDC        | 1SNA645034R2300  |
|  | RB 121-5VDC        | 1SNA645036R2500  |
|  | RBR 121-5VDC       | 1SNA645534R2500  |
|  | RBR 121-5VDC       | 1SNA645536R2700  |
|  | RB 121-12VDC       | 1SNA645069R0000  |
|  | RB 121-12VDC       | 1SNA645037R2600  |
|  | RBR 121-12VDC      | 1SNA645569R0000  |
|  | RBR 121-12VDC      | 1SNA645537R2000  |
|  | RB 101AR-24VAC/DC  | 1SNA645019R0400  |
|  | RBR 101AR-24VAC/DC | 1SNA645519R0600  |
|  | RB 111A-24VAC/DC   | 1SNA645014R2700  |
|  | RB 111AI-24VAC/DC  | 1SNA645063 R0000 |
|  | RB 111AR-24VAC/DC  | 1SNA645018R0300  |
|  | RBR 111A-24VAC/DC  | 1SNA645514R2100  |
|  | RBR 111AI-24VAC/DC | 1SNA645563R0200  |
|  | RBR 111AR-24VAC/DC | 1SNA645518R0500  |
|  | RB 121-24VDC       | 1SNA645064R0100  |
|  | RB 121-24VDC       | 1SNA645065R0200  |
|  | RB 121A-24VAC/DC   | 1SNA645001R0300  |
|  | RB 121A-24VAC/DC   | 1SNA645005R0700  |
|  | RB 121AI-24VAC/DC  | 1SNA645032R2100  |
|  | RB 121AI-24VAC/DC  | 1SNA645009R1300  |
|  | RB 121AI-24VAC/DC  | 1SNA645033R2200  |
|  | RB 121AI-24VAC/DC  | 1SNA645010R0700  |
|  | RBR 121-24VDC      | 1SNA645564R0300  |
|  | RBR 121-24VDC      | 1SNA645565R0400  |
|  | RBR 121A-24VAC/DC  | 1SNA645501R0500  |
|  | RBR 121A-24VAC/DC  | 1SNA645505R0100  |
|  | RBR 121AI-24VAC/DC | 1SNA645532R2300  |
|  | RBR 121AI-24VAC/DC | 1SNA645509R1500  |
|  | RBR 121AI-24VAC/DC | 1SNA645533R2400  |
|  | RBR 121AI-24VAC/DC | 1SNA645510R0100  |

| Input voltage  |   |   |   |   |   |   |   |   |   |   |   |   |   |   |   |   |   |   |   |   |   |   |   |   |   |
|----------------|---|---|---|---|---|---|---|---|---|---|---|---|---|---|---|---|---|---|---|---|---|---|---|---|---|
| 5 V DC         | ■ | ■ | ■ | ■ |   |   |   |   |   |   |   |   |   |   |   |   |   |   |   |   |   |   |   |   |   |
| 12 V DC        |   |   |   |   | ■ | ■ | ■ |   |   |   |   |   |   |   |   |   |   |   |   |   |   |   |   |   |   |
| 24 V DC        |   |   |   |   |   |   |   | ■ | ■ | ■ | ■ | ■ | ■ | ■ | ■ | ■ | ■ | ■ | ■ | ■ | ■ | ■ | ■ | ■ | ■ |
| 48 - 60 V DC   |   |   |   |   |   |   |   |   |   |   |   |   |   |   |   |   |   |   |   |   |   |   |   |   |   |
| 110 - 115 V DC |   |   |   |   |   |   |   |   |   |   |   |   |   |   |   |   |   |   |   |   |   |   |   |   |   |
| 230 V DC       |   |   |   |   |   |   |   |   |   |   |   |   |   |   |   |   |   |   |   |   |   |   |   |   |   |
| 60 - 230 V DC  |   |   |   |   |   |   |   |   |   |   |   |   |   |   |   |   |   |   |   |   |   |   |   |   |   |
| 24 V AC        |   |   |   |   |   |   |   | ■ | ■ | ■ | ■ | ■ | ■ | ■ | ■ | ■ | ■ | ■ | ■ | ■ | ■ | ■ | ■ | ■ | ■ |
| 48 - 60 V AC   |   |   |   |   |   |   |   |   |   |   |   |   |   |   |   |   |   |   |   |   |   |   |   |   |   |
| 115 V AC       |   |   |   |   |   |   |   |   |   |   |   |   |   |   |   |   |   |   |   |   |   |   |   |   |   |
| 230 V AC       |   |   |   |   |   |   |   |   |   |   |   |   |   |   |   |   |   |   |   |   |   |   |   |   |   |
| 60 - 230 V AC  |   |   |   |   |   |   |   |   |   |   |   |   |   |   |   |   |   |   |   |   |   |   |   |   |   |

| Output rating |   |   |   |   |   |   |   |   |   |   |   |   |   |   |   |   |   |   |   |   |   |   |   |   |   |
|---------------|---|---|---|---|---|---|---|---|---|---|---|---|---|---|---|---|---|---|---|---|---|---|---|---|---|
| 10 mA - 6 A   | ■ | ■ | ■ | ■ | ■ | ■ | ■ | ■ | ■ | ■ | ■ | ■ | ■ | ■ | ■ | ■ | ■ | ■ | ■ | ■ | ■ | ■ | ■ | ■ | ■ |
| 1 mA - 6 A    |   | ■ | ■ | ■ | ■ | ■ | ■ |   |   |   |   |   |   |   |   |   |   |   |   |   |   |   |   |   |   |
| 1 mA - 8 A    |   |   |   |   |   |   |   |   |   |   |   |   |   |   |   |   |   |   |   |   |   |   |   |   |   |

| Output contacts |   |   |   |   |   |   |   |   |   |   |   |   |   |   |  |  |  |  |  |  |  |  |  |  |  |
|-----------------|---|---|---|---|---|---|---|---|---|---|---|---|---|---|--|--|--|--|--|--|--|--|--|--|--|
| c/o             | 1 | 1 | 1 | 1 | 1 | 1 | 1 | 1 |   |   |   |   |   |   |  |  |  |  |  |  |  |  |  |  |  |
| n/o             |   |   |   |   |   |   |   |   | 1 | 1 | 1 | 1 | 1 | 1 |  |  |  |  |  |  |  |  |  |  |  |
| n/c             |   |   |   |   |   |   |   | 1 | 1 |   |   |   |   |   |  |  |  |  |  |  |  |  |  |  |  |

| Terminal type |   |   |   |   |   |   |   |  |   |   |   |  |  |  |  |  |  |  |  |  |  |  |  |  |  |
|---------------|---|---|---|---|---|---|---|--|---|---|---|--|--|--|--|--|--|--|--|--|--|--|--|--|--|
| Screw         | ■ | ■ |   | ■ | ■ |   | ■ |  | ■ | ■ | ■ |  |  |  |  |  |  |  |  |  |  |  |  |  |  |
| Spring        |   | ■ | ■ |   |   | ■ | ■ |  | ■ |   |   |  |  |  |  |  |  |  |  |  |  |  |  |  |  |



# Interface relays, R600 Benefits and advantages

## Characteristics

Standard range in screw clamp or spring clamp versions

- Spacing : 6 mm
- Wire size : 2.5 mm<sup>2</sup> (4 mm<sup>2</sup> solid wire)
- Contact type : 1 NO, 1 NC, 1 SPDT, 1 DPDT from 1 mA to 8 A / 250 V
- Transistor : 100 mA
  - MOS : 1 A to 5 A
  - Triac : 1 A to 2 A

6

## Benefits

### Increased contact life

The contacts are protected by built in RC-circuits which result in increased contact life.

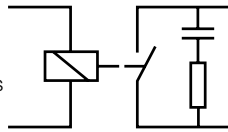

### Variety of connections

R600 relays and optocouplers are available with both screw terminals or spring terminals.

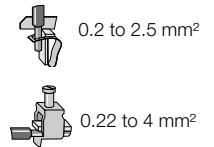

### Space saving

With a width of only 6 mm or 12 mm the compact design saves space in each cabinet.

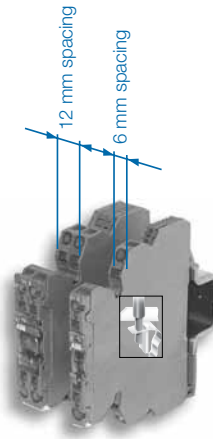

### Functioning status

Functioning display through a green LED.



### Only one part number AC/DC

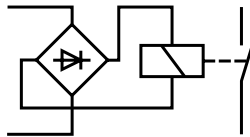

### Measurement & Test

Holes for holding DIA. 2 mm test plugs to simplify any measure or test.



## Excellent adaptation and conversion of digital signals

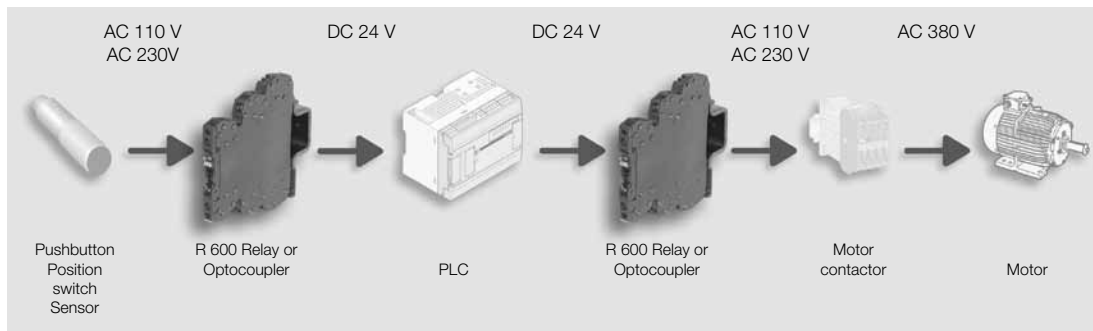

# Interface relays, R600

## Ordering details

Interface relays  
R600 & R500 Range



R600

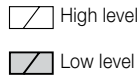

| R600 Relay   |  | Reference code        | Catalog number  | Pkg qty | Weight (1 pce) kg (lb) |
|--|--|-----------------------|-----------------|---------|------------------------|
| ☑ Relay module 1 NO high level 6 mm spacing                        |  | RB 111 A-24VAC/DC     | 1SNA645014R2700 | 10      | 0.02 (0.44)            |
|  |  | RB 111 A-48-60VAC/DC  | 1SNA645015R2000 |         |                        |
|  |  | RB 111 A-115VAC/DC    | 1SNA645016R2100 |         |                        |
|  |  | RB 111 A-230VAC/DC    | 1SNA645017R2200 |         |                        |
| ☑ Relay mod. 1 NO high level w/safety switch 6 mm spacing          |  | RB 111 AI-24VAC/DC    | 1SNA645063R0000 |         |                        |
| ☑ Relay mod. 1 NO/NC high level w/contact protection 12 mm spacing |  | RB 111 AR-24VAC/DC    | 1SNA645018R0300 | 5       | 0.03 (0.44)            |
|  |  | RB 101 AR-24VAC/DC    | 1SNA645019R0400 |         |                        |
| ☑ Relay module 1 NO high level 6 mm spacing                        |  | RBR 111 A-24VAC/DC    | 1SNA645514R2100 | 10      | 0.02 (0.44)            |
|  |  | RBR 111 A-48-60VAC/DC | 1SNA645515R2200 |         |                        |
|  |  | RBR 111 A-115VAC/DC   | 1SNA645516R2300 |         |                        |
| ☑ Relay mod. 1 NO high level w/safety switch 6 mm spacing          |  | RBR 111 AI-24VAC/DC   | 1SNA645563R0200 |         |                        |
|  |  | RBR 111 AR-24VAC/DC   | 1SNA645518R0500 | 5       | 0.03 (0.44)            |
| ☑ Relay mod. 1 NO/NC high level w/contact protection 12 mm spacing |  | RBR 101 AR-24VAC/DC   | 1SNA645519R0600 |         |                        |
| ☑ Relay module 1 SPDT high level                                   |  | RB 121-5VDC           | 1SNA645034R2300 | 10      | 0.02 (0.44)            |
|  |  | RB 121-12VDC          | 1SNA645069R0100 |         |                        |
|  |  | RB 121-24VDC          | 1SNA645064R0100 |         |                        |
|  |  | RB 121 A-24VAC/DC     | 1SNA645001R0300 |         |                        |
|  |  | RB 121 A-48-60VAC/DC  | 1SNA645002R0400 |         |                        |
|  |  | RB 121 A-115VAC/DC    | 1SNA645003R0500 |         |                        |
| ☑ Relay module 1 SPDT high level                                   |  | RB 121 A-230VAC/DC    | 1SNA645004R0400 | 10      | 0.02 (0.44)            |
|  |  | RB 121-5VDC           | 1SNA645534R2500 |         |                        |
|  |  | RB 121-12VDC          | 1SNA645569R0000 |         |                        |
|  |  | RB 121-24VDC          | 1SNA645564R0300 |         |                        |
|  |  | RB 121 A-24VAC/DC     | 1SNA645501R0500 |         |                        |
|  |  | RB 121 A-48-60VAC/DC  | 1SNA645502R0600 |         |                        |
| ☑ Relay module 1 SPDT low level                                    |  | RB 121 A-115VAC/DC    | 1SNA645503R0700 | 10      | 0.02 (0.44)            |
|  |  | RB 121 A-230VAC/DC    | 1SNA645504R0000 |         |                        |
|  |  | RB 121-5VDC           | 1SNA645036R2500 |         |                        |
|  |  | RB 121-12VDC          | 1SNA645037R2600 |         |                        |
|  |  | RB 121-24VDC          | 1SNA645065R0200 |         |                        |
|  |  | RB 121 A-24VAC/DC     | 1SNA645005R0700 |         |                        |
| ☑ Relay module 1 SPDT low level                                    |  | RB 121 A-48-60VAC/DC  | 1SNA645006R0000 | 10      | 0.02 (0.44)            |
|  |  | RB 121 A-115VAC/DC    | 1SNA645007R0100 |         |                        |
|  |  | RB 121 A-230VAC/DC    | 1SNA645008R1200 |         |                        |
|  |  | RB 121-5VDC           | 1SNA645536R2700 |         |                        |
|  |  | RB 121-12VDC          | 1SNA645537R2000 |         |                        |
|  |  | RB 121-24VDC          | 1SNA645565R0400 |         |                        |
| ☑ Relay module 1 SPDT low level                                    |  | RB 121 A-24VAC/DC     | 1SNA645505R0100 | 10      | 0.02 (0.44)            |
|  |  | RB 121 A-48-60VAC/DC  | 1SNA645506R0200 |         |                        |
|  |  | RB 121 A-115VAC/DC    | 1SNA645507R0300 |         |                        |
|  |  | RB 121 A-230VAC/DC    | 1SNA645508R1400 |         |                        |

### Accessories R600

|   | Reference code | Catalog number  | Pkg qty | Weight (1 pce) kg (lb) |
|---|----------------|-----------------|---------|------------------------|
| End section                               | BADH V0        | 011690027       | 50      |                        |
|   | BADL V0        | 039990302       | 50      |                        |
| Separator end section                     | BAM2 V0        | 039996701       | 50      |                        |
| Divisible shunt 10 poles                  | SC 612         | 1SNA290474R0200 | 10      |                        |
| Screw clamp distribution block sp. 12 mm  | BJ 612-10      | 1SNA290488R0100 | 10      |                        |
| Spring clamp distribution block sp. 12 mm | D4/12-3-3      | 1SNA645031R2000 | 5       |                        |
| Test plug DIA. 2 mm                       | D4/12-3R-3R    | 1SNA645531R2200 | 5       |                        |
| Marking method                            | FC2            | 000786526       | 10      |                        |
|   | RC65 / RC610   | see marking     |         |                        |

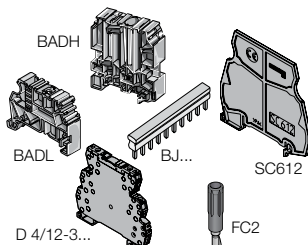

## Interface relays, R600

### Ordering details

6



R600

- High level
- Low level

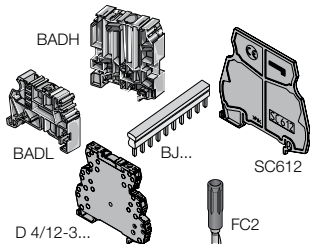

| R600 Relay  |  | Reference code        | Catalog number  | Pkg qty | Weight (1 pce) kg (lb) |
|---|--|-----------------------|-----------------|---------|------------------------|
| <input type="checkbox"/> Relay mod. 1SPDT high level w/leakage current protec.      |  | RB 121 AR-115VAC/DC   | 1SNA645046R0700 | 5       | 0.03 (0.066)           |
|   |  | RB 121 AR-230VAC/DC   | 1SNA645011R2400 |         |                        |
| <input type="checkbox"/> Relay mod. 1SPDT high level w/large coil voltage range     |  | RB 121 A 60-230VAC/DC | 1SNA645020R0100 |         |                        |
| <input type="checkbox"/> Relay mod. 1SPDT high level with switch                    |  | RB 121 AI-24VAC/DC    | 1SNA645032R2100 |         |                        |
| <input type="checkbox"/> Relay mod. 1SPDT high level with safety switch             |  | RB 121 AI-24VAC/DC    | 1SNA645009R1300 |         |                        |
| <input checked="" type="checkbox"/> Relay module 1SPDT low level with switch        |  | RB 121 AI-24VAC/DC    | 1SNA645033R2200 |         |                        |
| <input checked="" type="checkbox"/> Relay module 1SPDT low level with safety switch |  | RB 121 AI-24VAC/DC    | 1SNA645010R0700 |         |                        |
| <input type="checkbox"/> Relay mod. 1SPDT high level w/leakage current protec.      |  | RB 121 AR-115VAC/DC   | 1SNA645546R0100 |         |                        |
|   |  | RB 121 AR-230VAC/DC   | 1SNA645511R2600 |         |                        |
| <input type="checkbox"/> Relay mod. 1SPDT high level w/large coil voltage range     |  | RB 121 A 60-230VAC/DC | 1SNA645520R0300 |         |                        |
| <input type="checkbox"/> Relay mod. 1SPDT high level with switch                    |  | RB 121 AI-24VAC/DC    | 1SNA645532R2300 |         |                        |
| <input type="checkbox"/> Relay mod. 1SPDT high level with safety switch             |  | RB 121 AI-24VAC/DC    | 1SNA645509R1500 |         |                        |
| <input checked="" type="checkbox"/> Relay module 1SPDT low level with switch        |  | RB 121 AI-24VAC/DC    | 1SNA645533R2400 |         |                        |
| <input checked="" type="checkbox"/> Relay module 1SPDT low level with safety switch |  | RB 121 AI-24VAC/DC    | 1SNA645510R0100 |         |                        |
| <input checked="" type="checkbox"/> Relay module 1 DPDT low level                   |  | RB 122 A-24VAC/DC     | 1SNA645012R2500 | 5       | 0.03 (0.066)           |
|   |  | RB 122 A-48-60VAC/DC  | 1SNA645040R1500 |         |                        |
|   |  | RB 122 A-115VAC/DC    | 1SNA645041R0200 |         |                        |
|   |  | RB 122 A-230VAC/DC    | 1SNA645013R2600 |         |                        |
|   |  | RBR 122 A-24VAC/DC    | 1SNA645512R2700 |         |                        |
|   |  | RBR 122 A-48-60VAC/DC | 1SNA645540R1700 |         |                        |
| <input checked="" type="checkbox"/> Relay module 1 DPDT low level                   |  | RBR 122 A-115VAC/DC   | 1SNA645541R0400 |         |                        |
|   |  | RBR 122 A-230VAC/DC   | 1SNA645513R2000 |         |                        |

| Accessories R600                          | Reference code | Catalog number  | Pkg qty | Weight (1 pce) kg (lb) |
|---|----------------|-----------------|---------|------------------------|
| End section                               | BADH V0        | 011690027       | 50      |                        |
|   | BADL V0        | 039990302       | 50      |                        |
|   | BAM2 V0        | 039996701       | 50      |                        |
| Separator end section                     | SC 612         | 1SNA290474R0200 | 10      |                        |
| Divisible shunt 10 poles                  | BJ 612-10      | 1SNA290488R0100 | 10      |                        |
| Screw clamp distribution block sp. 12 mm  | D4/12-3-3      | 1SNA645031R2000 | 5       |                        |
| Spring clamp distribution block sp. 12 mm | D4/12-3R-3R    | 1SNA645531R2200 | 5       |                        |
| Test plug DIA. 2 mm                       | FC2            | 000786526       | 10      |                        |
| Marking method                            | RC65 / RC610   | see marking     |         |                        |

# Interface relays, R600

## Connection diagrams

Interface relays  
R600 & R500 Range

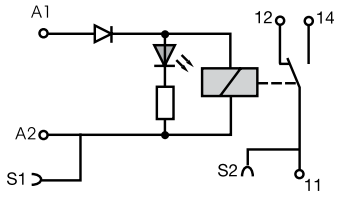

RB...121 - 5-12 V DC

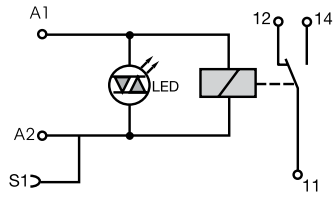

RB...121 - 24 V DC

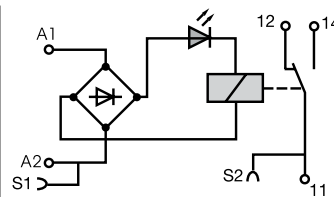

RB...121 A  
48-60-115-230 V AC/DC

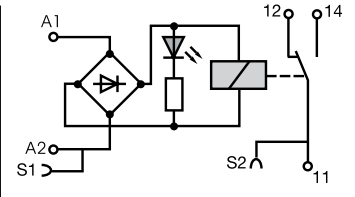

RB...121 A - 24 V AC/DC

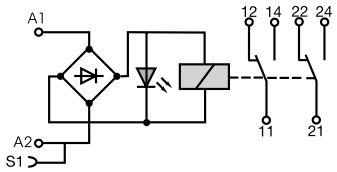

RB...122 A  
24-48-60 V AC/DC

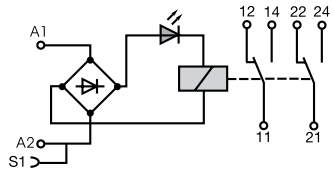

RB...122 A  
115-230 V AC/DC

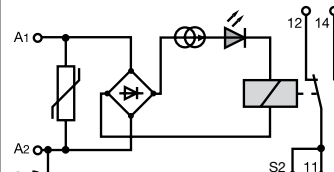

RB...121 A

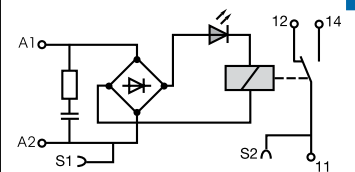

RB...121 AR

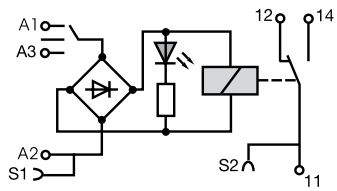

RB...121 AI

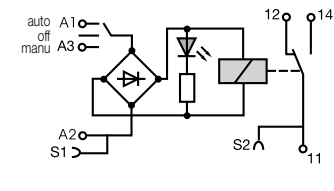

RB...121 AI

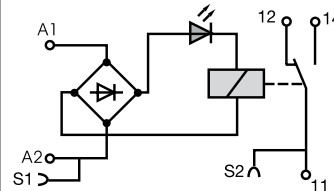

RB...121 A  
48-60-115-230 V AC/DC

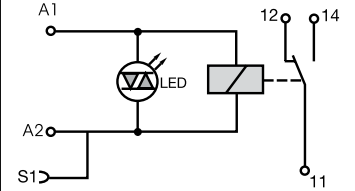

RB...121 - 12-24 V DC

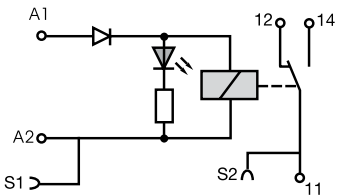

RB...121 - 5 V DC

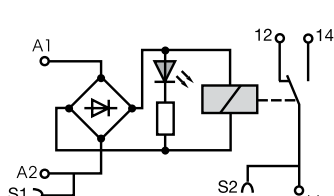

RB...121 A - 24 V AC/DC

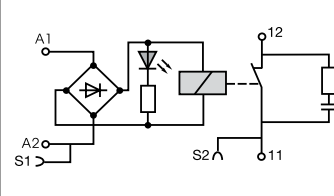

RB...101 AR

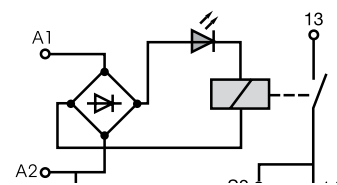

RB...111 A48-60-115-230 V AC/DC

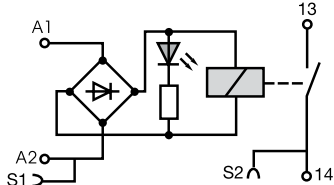

RB...111 A - 24 V AC/DC

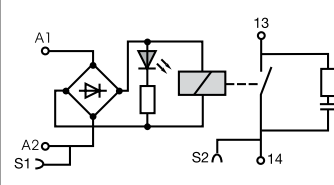

RB...111 AR

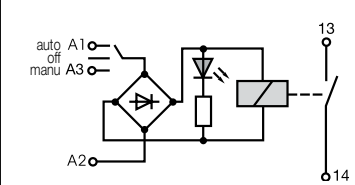

RB...111 AI

# Interface relays, R600

## Technical information

### Technical data

Relay : 1NO or 1NC high level contact 10 mA to 6 A - 6 mm .236" or 12 mm .472" spacing

|   |  | RB 111 A   |                                |           |            | RB 111 AI                                  | RB 111 AR  | RB 101 AR |            |
|---|--|--|--------------------------------|-----------|------------|--|------------|-----------|------------|
| <b>Relay characteristics coil</b>                 |  |  |                                |           |            |  |            |           |            |
| Rated voltage: +20%, -15% on DC ; 10%, -10% on AC |  | 24 VAC/DC  | 48 VAC/DC                      | 60 VAC/DC | 115 VAC/DC | 230 VAC/DC<br>±10% on AC<br>±10%-15% on DC | 24 VAC/DC  | 24 VAC/DC | 24 VAC/DC  |
| Frequency   |  | 50/60 Hz   |                                |           |            |  |            |           |            |
| Power   |  | 0.24 W   | 0.34 W                         | 0.54 W    | 0.46 W     | 0.8 W                                      | 0.24 W     | 0.24 W    | 0.24 W     |
| Rated current                                     |  | 10 mA  | 7 mA                           | 9 mA      | 4 mA       | 3.5 mA                                     | 10 mA      | 10 mA     | 10 mA      |
| Drop-out voltage at 20°C                          |  | 4.5 V  | 8 V                            | 8 V       | 17 V       | 27 V                                       | 4.5 V      | 4.5 V     | 4.5 V      |
| Status device                                     |  | green LED  |                                |           |            |  |            |           |            |
| <b>Relay characteristics contact</b>              |  |  |                                |           |            |  |            |           |            |
| Type  |  | 1 NO   |                                |           |            |  | 1 NO + RC  |           |            |
| Voltage switching range min./max.                 |  | 12 V / 250 VAC   |                                |           |            |  |            |           |            |
| Current switching range min./max.                 |  | 10 mA / 6 A  |                                |           |            |  |            |           |            |
| Load switching range                              |  | 0.6 VA / 1500 VA (ohmic load)  |                                |           |            |  |            |           |            |
| AC1 min./max.                                     |  | 0.6 W / 140 W  |                                |           |            |  |            |           |            |
| DC1 min./max.                                     |  | 10 <sup>5</sup> on AC15  |                                |           |            |  |            |           |            |
| Number of on-load operations                      |  | 10 <sup>7</sup>  |                                |           |            |  |            |           |            |
| Number of off-load operations                     |  | 10 <sup>7</sup>  |                                |           |            |  |            |           |            |
| Operation speed                                   |  | F  | 5 ms                           | 6 ms      | 7 ms       |  | 5 ms       |           |            |
|   |  | O  | 8 ms                           |           | 15 ms      |  | 8 ms       |           |            |
| Bounce  |  | 1.2 ms   |                                |           |            |  |            |           |            |
| Insulation coil / contact                         |  | 4000 V RMS   |                                |           |            |  | 3800 V RMS |           | 4000 V RMS |
| Resistance to shock coil / contact                |  | 4000 V RMS   |                                |           |            |  |            |           |            |
| Insulation contact / contact                      |  | 1000 V RMS   |                                |           |            |  |            |           |            |
| Ambient temperature                               |  | storage  | -40 °C to +80 °C               |           |            |  |            |           |            |
|   |  | operating  | -20 °C to +70 °C <sup>1)</sup> |           |            |  |            |           |            |
| <b>Other characteristics</b>                      |  | <b>Screw clamp</b>   |                                |           |            | <b>Spring clamp</b>                        |            |           |            |
| Body material                                     |  | grey   |                                |           |            | UL 94 V0                                   |            |           |            |
| Wire size   |  | Solid wire<br>0.2 - 4 mm <sup>2</sup> (24-12 AWG)  |                                |           |            | 0.2-2.5 mm <sup>2</sup> (24-12 AWG)        |            |           |            |
|   |  | Stranded wire  |                                |           |            | 0.22 - 2.5 mm <sup>2</sup> (24-12 AWG)     |            |           |            |
| Rated wire size                                   |  | 2.5 mm <sup>2</sup> (12 AWG)   |                                |           |            |  |            |           |            |
| Wire stripping length                             |  | 9 mm (0.354 in)  |                                |           |            |  |            |           |            |
| Recommended screwdriver                           |  | 3.5 mm (0.137 in)  |                                |           |            |  |            |           |            |
| Protection  |  | IP20 NEMA7   |                                |           |            |  |            |           |            |
| Recommended torque                                |  | 0.4-0.6 Nm (3.5-5.3 lb.in)   |                                |           |            |  |            |           |            |
| Approvals   |  | UL, (pending), LRS, CE   |                                |           |            |  |            |           |            |
| Reference standards                               |  | CEI 947-7-1 / CEI 947-1 / CEI 1131-2 (in relevant parts) / CEI 60664-1 / CEM : IRC 1000-4-2, 3, 4, 5, 6. |                                |           |            |  |            |           |            |

<sup>1)</sup> Over 55°C, blocks have to be mounted on horizontal rail with 10 mm spacing between each block. For vertical rail mounting use temperature is 15°C less decreased.

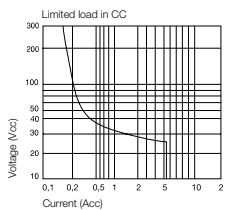

|           | DC12  | AC12 | DC13  | AC15 |
|-----------|-------|------|-------|------|
| 24 V      | 6 A   | 6 A  | 1 A   | 3 A  |
| 110/120 V | 0.3 A | 6 A  | 0.2 A | 3 A  |
| 220/230 V | 0.2 A | 6 A  | 0.1 A | 3 A  |

### Dimensional drawings

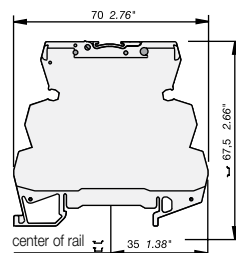

Screw clamp module

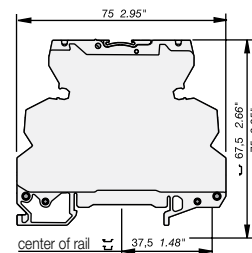

Spring clamp module



# Interface relays, R600

## Technical information

Interface relays  
R600 & R500 Range

### Technical data

Relay : 1 SPDT high level contact 10 mA to 6 A - 6 mm .236"

|   | RB 121   |  |         | RB 121A    |                                     |            |             |   |
|---|--|--|---------|------------|-------------------------------------|------------|-------------|---|
| <b>Relay characteristics coil</b>                 |  |  |         |            |                                     |            |             |   |
| Rated voltage: +20%, -15% on DC ; 10%, -10% on AC | 5 V DC   | 12 V DC                                | 24 V DC | 24 V AC/DC | 48 V AC/DC                          | 60 V AC/DC | 115 V AC/DC | 230 V AC/DC<br>± 10% on AC<br>± 10%-15% on DC |
| Frequency   | -  |  |         | 50/60 Hz   |                                     |            |             |   |
| Power   | 0.2 W  | 0.2 W                                  | 0.28 W  | 0.24 W     | 0.33 W                              | 0.54 W     | 0.46 W      | 0.8 W   |
| Rated current                                     | 40 mA  | 16 mA                                  | 12 mA   | 10 mA      | 7 mA                                | 9 mA       | 4 mA        | 3.5 mA  |
| Drop-out voltage at 20°C                          | 1.2 V  | 2.2 V                                  | 1.2 V   | 4.5 V      | 8 V                                 | 8 V        | 17 V        | 27 V  |
| Status device                                     | green LED  |  |         |            |                                     |            |             |   |
| <b>Relay characteristics contact</b>              |  |  |         |            |                                     |            |             |   |
| Type  | 1 SPDT   |  |         |            |                                     |            |             |   |
| Voltage switching range min./max.                 | 12 V / 250 V AC  |  |         |            |                                     |            |             |   |
| Current switching range min./max.                 | 10 mA / 6 A  |  |         |            |                                     |            |             |   |
| Load switching range                              | 0.6 VA / 1500 VA (ohmic load)  |  |         |            |                                     |            |             |   |
|   | AC1 min./max.  |  |         |            |                                     |            |             |   |
|   | DC1 min./max.  | 0.6 W / 140 W                          |         |            |                                     |            |             |   |
| Number of on-load operations                      | 10 <sup>5</sup> on AC15  |  |         |            |                                     |            |             |   |
| Number of off-load operations                     | 10 <sup>7</sup>  |  |         |            |                                     |            |             |   |
| Operation speed                                   | F  | 5 ms                                   |         |            | 6 ms                                |            | 7 ms        |   |
|   | O  | 8 ms                                   |         |            | 15 ms                               |            | 16 ms       |   |
| Bounce  | 1.2 ms   |  |         |            |                                     |            |             |   |
| Insulation coil / contact                         | 4000 V RMS   |  |         |            |                                     |            |             |   |
| Resistance to shock coil / contact                | 4000 V RMS   |  |         |            |                                     |            |             |   |
| Insulation contact / contact                      | 1000 V RMS   |  |         |            |                                     |            |             |   |
| Ambient temperature                               | storage  | -40 °C to -80 °C                       |         |            |                                     |            |             |   |
|   | operating  | -20 °C to 70 °C <sup>1)</sup>          |         |            |                                     |            |             |   |
| <b>Other characteristics</b>                      |  |  |         |            |                                     |            |             |   |
| Body material                                     | grey   | Screw clamp                            |         |            | Spring clamp                        |            |             |   |
| Wire size   | Solid wire   | 0.2 - 4 mm <sup>2</sup> (24-12 AWG)    |         |            | 0.2-2.5 mm <sup>2</sup> (24-12 AWG) |            |             |   |
|   | Stranded wire  | 0.22 - 2.5 mm <sup>2</sup> (24-12 AWG) |         |            |                                     |            |             |   |
| Rated wire size                                   | 2.5 mm <sup>2</sup> (12 AWG)   |  |         |            |                                     |            |             |   |
| Wire stripping length                             | 9 mm (0.354 in)  |  |         |            |                                     |            |             |   |
| Recommended screwdriver                           | 3.5 mm (0.137 in)  |  |         |            |                                     |            |             |   |
| Protection  | IP20 NEMA1   |  |         |            |                                     |            |             |   |
| Recommended torque                                | 0.4-0.6 Nm (3.5-5.3 lb.in)   |  |         |            |                                     |            |             |   |
| Approvals   | UL (pending for 12 V DC) , CE (pending) , LRS , CE   |  |         |            |                                     |            |             |   |
| Reference standards                               | CEI 947-7-1 / CEI 947-1 / CEI 1131-2 (in relevant parts) / CEI 60664-1 / CEM : IRC 1000-4-2, 3, 4, 5, 6. |  |         |            |                                     |            |             |   |

<sup>1)</sup> Over 55°C, blocks have to be mounted on horizontal rail with 10 mm spacing between each block. For vertical rail mounting use temperature is 15°C less decreased.

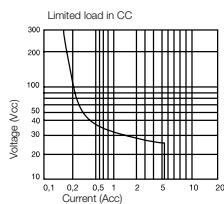

|           | DC12  | AC12 | DC13  | AC15 |
|-----------|-------|------|-------|------|
| 24 V      | 6 A   | 6 A  | 1 A   | 3 A  |
| 110/120 V | 0.3 A | 6 A  | 0.2 A | 3 A  |
| 220/230 V | 0.2 A | 6 A  | 0.1 A | 3 A  |

### Dimensional drawings

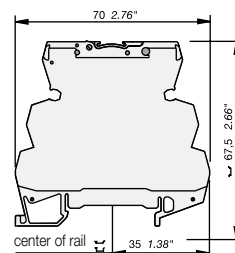

Screw clamp module

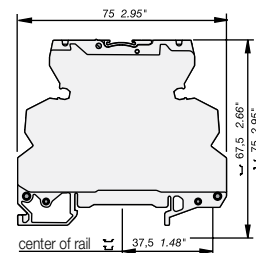

Spring clamp module

# Interface relays, R600

## Technical information

### Technical data

Relay : 1 SPDT low level with contact 1 mA upto 6 A - 6 m 0.236" spacing

|   | RB 121    |         |         | RB 121 A  |           |            |             |   |
|---|-----------|---------|---------|-----------|-----------|------------|-------------|---|
| <b>Relay characteristics coil</b>                 |           |         |         |           |           |            |             |   |
| Rated voltage: +20%, -15% on DC ; 10%, -10% on AC | 5 V DC    | 12 V DC | 24 V DC | 24 VAC/DC | 48 VAC/DC | 60 V AC/DC | 115 V AC/DC | 230 V AC/DC<br>± 10% on AC<br>± 10%-15% on DC |
| Frequency   | 50/60 Hz  |         |         |           |           |            |             |   |
| Power   | 0.2 W     | 0.2 W   | 0.28 W  | 0.24 W    | 0.33 W    | 0.54 W     | 0.46 W      | 0.8 W   |
| Rated current                                     | 40 mA     | 16 mA   | 12 mA   | 10 mA     | 7 mA      | 9 mA       | 4 mA        | 3.5 mA  |
| Drop-out voltage at 20°C                          | 1.2 V     | 2.2 V   | 1.2 V   | 4.5 V     | 8 V       | 8 V        | 17 V        | 27 V  |
| Status device                                     | green LED |         |         |           |           |            |             |   |

### Relay characteristics contact

|                                    |                                |                               |      |      |      |      |      |       |       |
|------------------------------------|--------------------------------|-------------------------------|------|------|------|------|------|-------|-------|
| Type                               | 1 SPDT                         |                               |      |      |      |      |      |       |       |
| Voltage switching range min./max.  | 5 V / 250 V AC                 |                               |      |      |      |      |      |       |       |
| Current switching range min./max.  | 1 mA / 6 A                     |                               |      |      |      |      |      |       |       |
| Load switching range               | 0.05 VA / 1500 VA (ohmic load) |                               |      |      |      |      |      |       |       |
|                                    | 0.05 W / 140 W                 |                               |      |      |      |      |      |       |       |
| Number of on-load operations       | 10 <sup>5</sup> on AC15        |                               |      |      |      |      |      |       |       |
| Number of off-load operations      | 10 <sup>7</sup>                |                               |      |      |      |      |      |       |       |
| Operation speed                    | F                              | 5 ms                          | 5 ms | 5 ms | 5 ms | 5 ms | 5 ms | 6 ms  | 7 ms  |
|                                    | O                              | 8 ms                          | 8 ms | 8 ms | 8 ms | 8 ms | 8 ms | 15 ms | 16 ms |
| Insulation coil / contact          | 4000 V RMS                     |                               |      |      |      |      |      |       |       |
| Resistance to shock coil / contact | 4000 V RMS                     |                               |      |      |      |      |      |       |       |
| Insulation contact / contact       | 1000 V RMS                     |                               |      |      |      |      |      |       |       |
| Ambient temperature                | storage                        | -40 °C to -80 °C              |      |      |      |      |      |       |       |
|                                    | operating                      | -20 °C to 70 °C <sup>1)</sup> |      |      |      |      |      |       |       |

### Other characteristics

|                         | Screw clamp  | Spring clamp                           |
|-------------------------|--|--|
| Body material           | grey   | UL 94 V0                               |
| Wire size               | Solid wire<br>0.2 - 4 mm <sup>2</sup> (24-12 AWG)  | 0.2-2.5 mm <sup>2</sup> (24-12 AWG)    |
|                         | Stranded wire  | 0.22 - 2.5 mm <sup>2</sup> (24-12 AWG) |
| Rated wire size         | 2.5 mm <sup>2</sup> (12 AWG)   |  |
| Wire stripping length   | 9 mm (0.354 in)  |  |
| Recommended screwdriver | 3.5 mm (0.137 in)  |  |
| Protection              | IP20 NEMA7   |  |
| Recommended torque      | 0.4-0.6 Nm (3.5-5.3 lb.in)   |  |
| Approvals               | UL (pending for 24 V DC), CE (pending), LRS, CE  |  |
| Reference standards     | CEI 947-7-1 / CEI 947-1 / CEI 1131-2 (in relevant parts) / CEI 60664-1 / CEM : IRC 1000-4-2, 3, 4, 5, 6. |  |

<sup>1)</sup> Over 55°C, blocks have to be mounted on horizontal rail with 10 mm spacing between each block. For vertical rail mounting use temperature is 15°C less decreased.

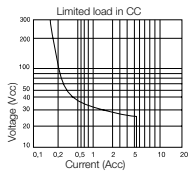

|           | DC12  | AC12 | DC13  | AC15 |
|-----------|-------|------|-------|------|
| 24 V      | 6 A   | 6 A  | 1 A   | 3 A  |
| 110/120 V | 0.3 A | 6 A  | 0.2 A | 3 A  |
| 220/230 V | 0.2 A | 6 A  | 0.1 A | 3 A  |

### Dimensional drawings

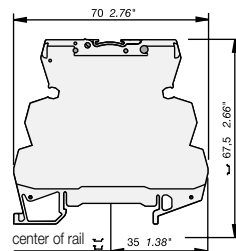

Screw clamp module

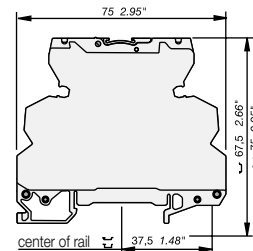



Spring clamp module

# Interface relays, R600

## Technical information

Interface relays  
R600 & R500 Range

### Technical data

-  Relay : 1 SPDT high level with switch or large coil voltage range or with leakage current protection 12 mm 0.472" spacing  
 Relay : 1 SPDT low level with switch - 12 mm 0.472" spacing

|   | RB 121 AR  |   | RB 121AI  |                                | RB 121 AI                              |                                | RB 121 AI        |                               |  |
|---|--|---|-----------|--------------------------------|--|--------------------------------|------------------|-------------------------------|--|
| <b>Relay characteristics coil</b>                 |  |   |           |                                |  |                                |                  |                               |  |
| Rated voltage: +20%, -15% on DC ; 10%, -10% on AC | 115 V AC/DC  | 230 V AC/DC<br>± 10% on AC<br>± 10%-15% on DC | 24 VAC/DC |                                | 24 VAC/DC                              |                                | 60 to 253 VAC/DC |                               |  |
| Frequency   | 50/60 Hz   |   |           |                                |  |                                |                  |                               |  |
| Power   | 2 W  | 2.8 W   | 0.24 W    |                                | 0.24 W                                 |                                | 1 W              |                               |  |
| Rated current                                     | 18 mA  | 12 mA   | 10 mA     |                                | 10 mA                                  |                                | 4 mA max.        |                               |  |
| Drop-out voltage at 20°C                          | 17 V   | 27 V  | 4.5 V     |                                | 4.5 V                                  |                                | 15 V             |                               |  |
| Permissible leakage current                       | 1.6 mA   | 1 mA  |           |                                |  |                                |                  |                               |  |
| Status device                                     | green LED  |   |           |                                |  |                                |                  |                               |  |
| <b>Relay characteristics contact</b>              |  |   |           |                                |  |                                |                  |                               |  |
| Type  | 1 SPDT   |   |           |                                |  |                                |                  |                               |  |
| Voltage switching range min./max.                 | 12 V / 250 V AC  |   |           |                                | 5 V / 250 V                            |                                | 12 V / 250 V     |                               |  |
| Current switching range min./max.                 | 10 mA / 6 A  |   |           |                                |  |                                |                  |                               |  |
| Load switching range                              | AC1 min./max.  | 0.6 VA / 1500 VA (ohmic load)                 |           |                                |  | 0.05 VA / 1500 VA (ohmic load) |                  | 0.6 VA / 1500 VA (ohmic load) |  |
|   | DC1 min./max.  | 0.6 W / 140 W                                 |           |                                |  | 0.05 W / 140 W                 |                  | 0.6 W / 140 W                 |  |
| Number of on-load operations                      | 10 <sup>5</sup> on AC15  |   |           |                                |  |                                |                  |                               |  |
| Number of off-load operations                     | 10 <sup>7</sup>  |   |           |                                |  |                                |                  |                               |  |
| Operation speed                                   | F  | 6 ms  | 7 ms      | 5 ms                           | 5 ms                                   | 5 ms                           | 7 ms             |                               |  |
|   | O  | 15 ms   | 16 ms     | 8 ms                           | 8 ms                                   | 8 ms                           | 20 ms            |                               |  |
| Insulation coil / contact                         | 4000 V RMS   |   |           |                                |  |                                |                  |                               |  |
| Resistance to shock coil / contact                | 4000 V RMS   |   |           |                                |  |                                |                  |                               |  |
| Insulation contact / contact                      | 1000 V RMS   |   |           |                                |  |                                |                  |                               |  |
| Ambient temperature                               | storage  | -40 °C to -80 °C                              |           |                                |  |                                |                  |                               |  |
|   | operating  | -20 °C to 70 °C <sup>1)</sup>                 |           |                                |  |                                |                  |                               |  |
| <b>Other characteristics</b>                      |  |   |           |                                |  |                                |                  |                               |  |
| Body material                                     | grey   | Screw clamp                                   |           |                                | Spring clamp                           |                                |                  |                               |  |
|   |  | UL 94 V0                                      |           |                                |  |                                |                  |                               |  |
| Wire size   | Solid wire   | 0.2 - 4 mm <sup>2</sup> (24-12 AWG)           |           |                                | 0.2-2.5 mm <sup>2</sup> (24-12 AWG)    |                                |                  |                               |  |
|   | Stranded wire  |   |           |                                | 0.22 - 2.5 mm <sup>2</sup> (24-12 AWG) |                                |                  |                               |  |
| Rated wire size                                   |  |   |           | 2.5 mm <sup>2</sup> (12 AWG)   |  |                                |                  |                               |  |
| Wire stripping length                             |  |   |           | 9 mm (0.354 in)                |  |                                |                  |                               |  |
| Recommended screwdriver                           |  |   |           | 3.5 mm (0.137 in)              |  |                                |                  |                               |  |
| Protection  |  |   |           | IP20 NEMA1                     |  |                                |                  |                               |  |
| Recommended torque                                |  |   |           | 0.4-0.6 Nm (3.5-5.3 lb.in)     |  |                                |                  |                               |  |
| Approvals   |  |   |           | cRUus, (pending), (B), LRS, CE |  |                                |                  |                               |  |
| Reference standards                               | CEI 947-7-1 / CEI 947-1 / CEI 1131-2 (in relevant parts) / CEI 60664-1 / CEM : IRC 1000-4-2, 3, 4, 5, 6. |   |           |                                |  |                                |                  |                               |  |

<sup>1)</sup> Over 55°C, blocks have to be mounted on horizontal rail with 10 mm spacing between each block. For vertical rail mounting use temperature is 15°C less decreased.

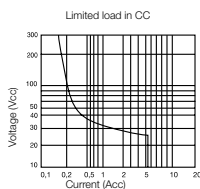

|           | DC12  | AC12 | DC13  | AC15 |
|-----------|-------|------|-------|------|
| 24 V      | 6 A   | 6 A  | 1 A   | 3 A  |
| 110/120 V | 0.3 A | 6 A  | 0.2 A | 3 A  |
| 220/230 V | 0.2 A | 6 A  | 0.1 A | 3 A  |

### Dimensional drawings

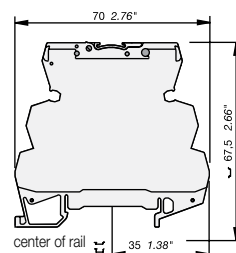

Screw clamp module

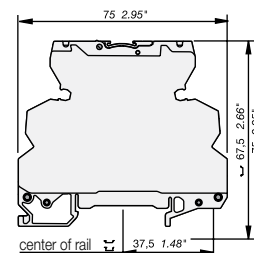

Spring clamp module

# Interface relays, R600

## Technical information

### Technical data

Relay : 1 DPDT low level contact 1 mA to 8 A - 12 mm 0.472" spacing

6

|   |                                 | RB ... 122A  |            |  |   |       |
|---|---------------------------------|--|------------|--|---|-------|
| <b>Relay characteristics coil</b>                 |                                 |  |            |  |   |       |
| Rated voltage: +20%, -15% on DC ; 10%, -10% on AC | 24 V AC/DC                      | 48 V AC/DC   | 60 V AC/DC | 115 V AC/DC                            | 230 V AC/DC<br>± 10% on AC<br>± 10%-15% on DC |       |
| Frequency   | 50/60 Hz                        |  |            |  |   |       |
| Power   | 0.48 W                          | 0.62 W   | 0.96 W     | 0.58 W                                 | 1.15 W  |       |
| Rated current                                     | 20 mA                           | 13 mA  | 16 mA      | 5 mA                                   | 5 mA  |       |
| Drop-out voltage at 20°C                          | 5.4 V                           | 8.8 V  | 8.8 V      | 20 V                                   | 10 V  |       |
| Status device                                     | green LED                       |  |            |  |   |       |
| <b>Relay characteristics contact</b>              |                                 |  |            |  |   |       |
| Type  | 1 DPDT                          |  |            |  |   |       |
| Voltage switching range min./max.                 | 5 V / 250 V DC - 250 V AC       |  |            |  |   |       |
| Current switching range min./max.                 | 1 mA / 8 A                      |  | 1 mA / 5 A |  |   |       |
| Load switching range                              | 5 mVA / 1500 VA (ohmic load)    |  |            |  |   |       |
|   | 5 mW / 192 W                    |  |            |  |   |       |
| Number of on-load operations                      | 10 <sup>5</sup>                 |  |            |  |   |       |
| Number of off-load operations                     | 2 x 10 <sup>7</sup>             |  |            |  |   |       |
| Operation speed                                   | F                               | 6 ms   | 10 ms      | 10 ms                                  | 6 ms  | 6 ms  |
|   | O                               | 10 ms  | 14 ms      | 14 ms                                  | 15 ms   | 15 ms |
| Bounce  | 1 ms                            |  |            |  |   |       |
| Insulation coil / contact                         | 3500 V RMS                      |  |            |  |   |       |
| Resistance to shock coil / contact                | 3500 V RMS                      |  |            |  |   |       |
| Insulation contact / contact                      | 3500 V RMS (between 2 contacts) |  |            |  |   |       |
| Ambient temperature                               | storage                         | -40 °C to -80 °C   |            |  |   |       |
|   | operating                       | -20 °C to 70 °C <sup>1)</sup>  |            |  |   |       |
| <b>Other characteristics</b>                      |                                 | <b>Screw clamp</b>   |            | <b>Spring clamp</b>                    |   |       |
| Body material                                     | grey                            | UL 94 V0   |            |  |   |       |
| Wire size   | Solid wire                      | 0.2 - 4 mm <sup>2</sup> (24-12 AWG)  |            | 0.2-2.5 mm <sup>2</sup> (24-12 AWG)    |   |       |
|   | Stranded wire                   |  |            | 0.22 - 2.5 mm <sup>2</sup> (24-12 AWG) |   |       |
| Rated wire size                                   |                                 |  |            | 2.5 mm <sup>2</sup> (12 AWG)           |   |       |
| Wire stripping length                             |                                 |  |            | 9 mm (0.354 in)                        |   |       |
| Recommended screwdriver                           |                                 |  |            | 3.5 mm (0.137 in)                      |   |       |
| Protection  |                                 |  |            | IP20 NEMA1                             |   |       |
| Recommended torque                                |                                 |  |            | 0.4-0.6 Nm (3.5-5.3 lb.in)             |   |       |
| Approvals   |                                 | UL (pending for 12 V DC) , CE (pending), LRS , CE  |            |  |   |       |
| Reference standards                               |                                 | CEI 947-7-1 / CEI 947-1 / CEI 1131-2 (in relevant parts) / CEI 60664-1 / CEM : IRC 1000-4-2, 3, 4, 5, 6. |            |  |   |       |

<sup>1)</sup> Over 55°C, blocks have to be mounted on horizontal rail with 10 mm spacing between each block. For vertical rail mounting use temperature is 15°C less decreased.

Max. DC load breaking capacity

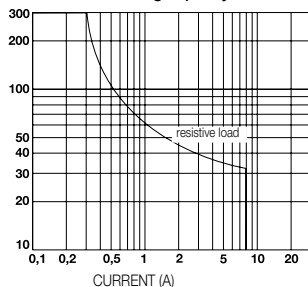

### Dimensional drawings

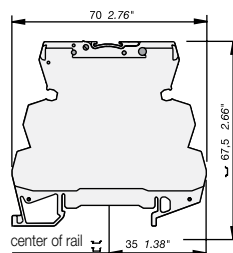

Screw clamp module

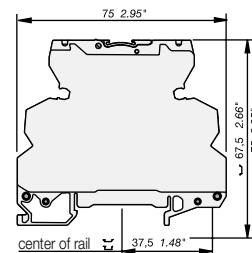

Spring clamp module

# Interface relays, R500 Selection

Interface relays  
R600 & R500 Range

|                        | Reference code          | Catalog number  |
|------------------------|-------------------------|-----------------|
|                        | D 2,5/5-R121-24VDC      | 1SNA645047R0000 |
|                        | D 2,5/5-R121L-24VDC     | 1SNA645547R0200 |
|                        | D 2,5/5-R121AL-24VAC/DC | 1SNA645021R2600 |
|                        | D 2,5/5-R121AL-48VAC/DC | 1SNA645521R2000 |
|                        | D 2,5/5-R121BL-110VAC   | 1SNA645049R1200 |
|                        | D 2,5/5-R121BL-230VAC   | 1SNA645549R1400 |
| <b>Input voltage</b>   |                         |                 |
| 24 V DC                | ■                       | ■               |
| 48 V DC                |                         | ■               |
| 24 V AC                |                         | ■               |
| 48 V AC                |                         | ■               |
| 110 V AC               |                         | ■               |
| 230 V AC               |                         | ■               |
| <b>Output rating</b>   |                         |                 |
| 10 mA - 6 A            | ■                       | ■               |
| <b>Output contacts</b> |                         |                 |
| c/o                    | 1                       | 1               |
| <b>Type</b>            |                         |                 |
| with LED               |                         | ■               |
| without LED            | ■                       |                 |



## R500 series

It is our range offering pluggable functions

- Spacing : 5.08 mm (the smallest in the market)
- Wire size : 2.5 mm<sup>2</sup> (4 mm<sup>2</sup> solid)
- Contact type : 1 SPDT from 10 mA to 6 A / 250 V
- Transistor : 30 mA to 100 mA  
MOS : 1 A to 2 A  
Triac : 1 A

## Interface relays, R500

### Ordering details

6



R500

| Description of R500 Relay  | Reference code          | Catalog number  | Pkg qty | Weight (1 pce) kg (lb) |
|--|-------------------------|-----------------|---------|------------------------|
| <input type="checkbox"/> Relay module 1 SPDT high level          | D 2,5/5-R121-24VDC      | 1SNA607217R0200 | 10      | 0.032 (0.071)          |
|  | D 2,5/5-R121L-24VDC     | 1SNA607201R1300 |         |                        |
|  | D 2,5/5-R121AL-24VAC/DC | 1SNA607231R0000 |         |                        |
| <input type="checkbox"/> Relay module with LED 1 SPDT high level | D 2,5/5-R121AL-48VAC/DC | 1SNA607232R0100 | 10      | 0.04 (0.088)           |
|  | D 2,5/5-R121BL-110VAC   | 1SNA607264R1100 |         |                        |
|  | D 2,5/5-R121BL-230VAC   | 1SNA607265R1200 |         |                        |

| R500 Accessories                      | Reference code      | Catalog number  | Pkg qty | Weight (1 pce) kg (lb) |
|---------------------------------------|---------------------|-----------------|---------|------------------------|
| High end stop                         | BAMH 9,1 mm         | 011483600       | 50      |                        |
|                                       | BAMH V0 9,1 mm      | 019483601       |         |                        |
|                                       | BADH 12 mm          | 011690027       |         |                        |
| Comb type jumper bar 2 to 22 poles    |                     | consult us      |         |                        |
| Jumper bar 10 poles grey ■            | PCMS V0             | 1SNA205523R2200 | 8       |                        |
| Relay / Opto base                     | D 2,5/5-MP          | 1SNA607224R0100 | 10      | 0.028 (0.062)          |
| Relay / Opto base with LED 24 VDC     | D 2,5/5-MP-24VDC    | 1SNA607222R0700 |         |                        |
| Relay / Opto base with LED 24 VAC/VDC | D 2,5/5-MP-24VAC/DC | 1SNA607260R2100 |         |                        |
| Relay / Opto base with LED 48 VAC/VDC | D 2,5/5-MP-48VAC/DC | 1SNA607261R1600 |         |                        |
| Relay / Opto base with LED 110 VAC    | D 2,5/5-MP-110VAC   | 1SNA607266R1300 |         |                        |
| Relay / Opto base with LED 230 VAC    | D 2,5/5-MP-230VAC   | 1SNA607267R1400 |         |                        |
| Plug relay 24 V 1 SPDT 10 mA to 6 A   | BNMS R24V-1         | 1SNA031820R1400 | 4       |                        |
| Plug relay 24 V 1 SPDT 1 mA to 6 A    | BNMS R24V-2         | 1SNA031847R1300 |         |                        |
| Test device blue                      | DCB <sup>1)</sup>   | 1SNA105028R2100 | 10      |                        |
| Test plug DIA. 2 mm                   | FC2                 | 000786526       |         |                        |
| Marking method                        | RC55                | see marking     |         |                        |

<sup>1)</sup> Only on top decks

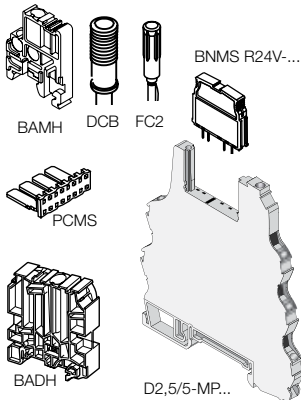

### Connection diagrams

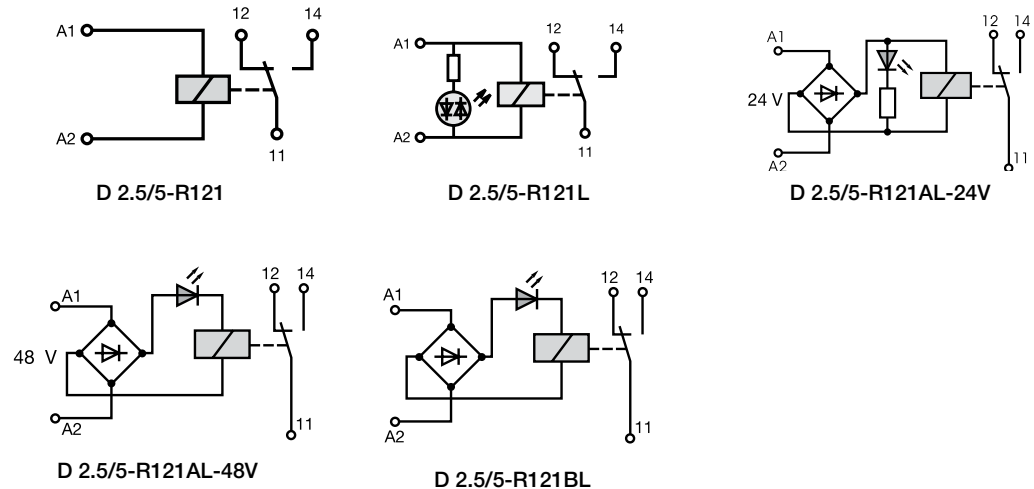

# Interface relays, R500

## Technical information



Interface relays  
R600 & R500 Range

### Technical data

Relay : 1 SPDT high level with contact 10 mA to 6 A - 5.08mm 0.200" spacing

|   | D 2.5/5-R121 | D 2.5/5-R121L | D 2.5/5-R121AL |         |          |         | D 2.5/5-R121BL |          |
|---|--------------|---------------|----------------|---------|----------|---------|----------------|----------|
| <b>Relay characteristics coil</b>                 |              |               |                |         |          |         |                |          |
| Rated voltage: +20%, -15% on DC ; 10%, -10% on AC | 24 V DC      | 24 V DC       | 24 V AC        | 24 V DC | 48 V AC  | 48 V DC | 110 V AC       | 230 V AC |
| Frequency   |              |               | 50/60 Hz       |         | 50/60 Hz |         | 50/60 Hz       | 50/60 Hz |
| Power   | 0.17 W       | 0.3 W         | 0.35 W         | 0.35 W  | 0.44 W   | 0.47 W  | 1.08 W         | 2.13 W   |
| Rated current                                     | 7 mA         | 12 mA         | 12.4 mA        | 10 mA   | 7.6 mA   | 6.8 mA  | 8.4 mA         | 8 mA     |
| Drop-out voltage at 20°C                          | 2.4 V        | 2.4 V         | 4.8 V          | 4.8 V   | 10 V     | 10 V    | 25 V           | 45 V     |
| Status device                                     | green LED    |               |                |         |          |         |                |          |

|                                      |                         |      |      |       |                               |       |       |                     |       |
|--------------------------------------|-------------------------|------|------|-------|-------------------------------|-------|-------|---------------------|-------|
| <b>Relay characteristics contact</b> |                         |      |      |       |                               |       |       |                     |       |
| Type                                 | 1 SPDT                  |      |      |       |                               |       |       |                     |       |
| Voltage switching range min./max.    | 12 V / 250 V AC         |      |      |       |                               |       |       |                     |       |
| Current switching range min./max.    | 10 mA / 6 A             |      |      |       |                               |       |       |                     |       |
| Load switching range                 | AC1 min./max.           |      |      |       | 0.6 VA / 1500 VA (ohmic load) |       |       |                     |       |
|                                      | DC1 min./max.           |      |      |       | 0.6 W / 140 W                 |       |       |                     |       |
| Number of on-load operations         | 10 <sup>5</sup> on AC15 |      |      |       |                               |       |       |                     |       |
| Number of off-load operations        | 10 x 10 <sup>7</sup>    |      |      |       |                               |       |       |                     |       |
| Operation speed                      | F                       | 5 ms | 5 ms | 5 ms  | 5 ms                          | 5 ms  | 5 ms  | 6 ms                | 7 ms  |
|                                      | O                       | 8 ms | 8 ms | 15 ms | 15 ms                         | 15 ms | 15 ms | 15 ms               | 15 ms |
| Insulation coil / contact            | 4000 V RMS              |      |      |       |                               |       |       |                     |       |
| Resistance to shock coil / contact   | 4000 V RMS              |      |      |       |                               |       |       |                     |       |
| Insulation contact / contact         | 1000 V RMS              |      |      |       |                               |       |       |                     |       |
| Ambient temperature                  | storage                 |      |      |       |                               |       |       |                     |       |
|                                      | operating               |      |      |       |                               |       |       |                     |       |
|                                      |                         |      |      |       |                               |       |       | -40 °C to -80 °C    |       |
|                                      |                         |      |      |       |                               |       |       | See derating curves |       |

|                              |  |  |  |  |  |  |  |  |
|------------------------------|--|--|--|--|--|--|--|--|
| <b>Other characteristics</b> |  |  |  |  |  |  |  |  |
| Body material                | grey   |  |  |  | UL 94 V0                               |  |  |  |
| Wire size                    | Solid wire   |  |  |  | 0.2 - 4 mm <sup>2</sup> (24-12 AWG)    |  |  |  |
|                              | Stranded wire  |  |  |  | 0.22 - 2.5 mm <sup>2</sup> (24-12 AWG) |  |  |  |
| Rated wire size              | 2.5 mm <sup>2</sup> (12 AWG)   |  |  |  |  |  |  |  |
| Wire stripping length        | 10 mm (0.394 in)   |  |  |  |  |  |  |  |
| Recommended screwdriver      | 3.5 mm (0.137 in)  |  |  |  |  |  |  |  |
| Protection                   | IP20 NEMA1   |  |  |  |  |  |  |  |
| Recommended torque           | 0.4-0.6 Nm (3.5-5.3 lb.in)   |  |  |  |  |  |  |  |
| Approvals                    |  us (pending) ,  |  |  |  |  |  |  |  |
| Reference standards          | CEI 947-7-1 / CEI 947-1 / CEI 1131-2 (in relevant parts) / CEI 60664-1 / CEM : IRC 1000-4-2, 3, 4, 5, 6.   |  |  |  |  |  |  |  |

|           | DC12  | AC12 | DC13  | AC15 |
|-----------|-------|------|-------|------|
| 24 V      | 6 A   | 6 A  | 1 A   | 3 A  |
| 110/120 V | 0.3 A | 6 A  | 0.2 A | 3 A  |
| 220/230 V | 0.2 A | 6 A  | 0.1 A | 3 A  |

### Dimensional drawings

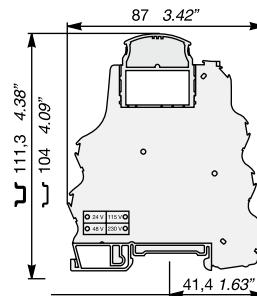
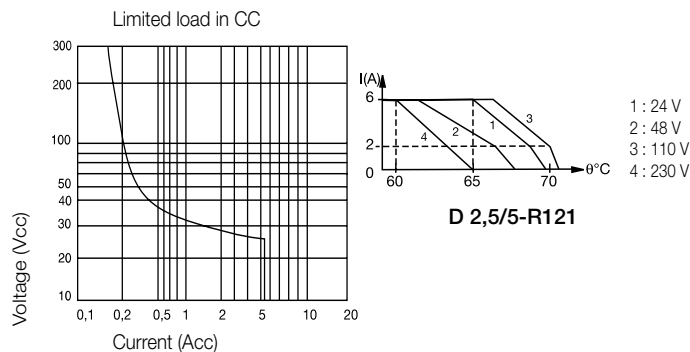







Optocouplers  
R600 & R500

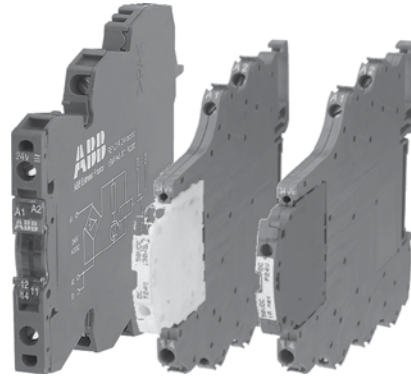

# R600 & R500 Optocouplers



# R600 Optocouplers Selection

|                        |                 |
|------------------------|-----------------|
| OBROA 1000-24VDC       | 1SNA645527R2600 |
| OBROA 2000-24VDC       | 1SNA645529R0000 |
| OBOA 1000-48-60VAC/DC  | 1SNA645061R0600 |
| OBROA 1000-48-60VAC/DC | 1SNA645561R0000 |
| OBOA 1000-115VAC/DC    | 1SNA645062R0700 |
| OBROA 1000-115VAC/DC   | 1SNA645562R0100 |
| OBOA 1000-230VAC/DC    | 1SNA645028R0500 |
| OBROA 1000-230VAC/DC   | 1SNA645528R0700 |

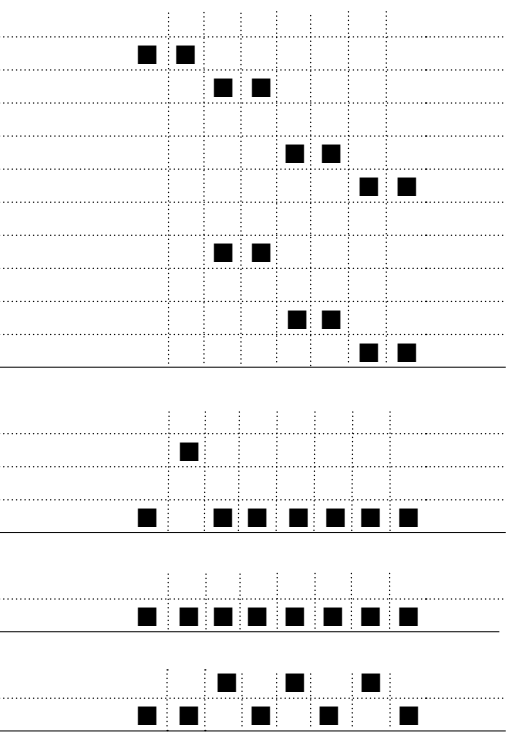

## R600 Optocouplers

### Ordering details

6



| R600 Optocoupler                        |  | Reference code           | Catalog number    | Pkg qty | Weight (1 pce)<br>kg (lb) |
|---|--|--------------------------|-------------------|---------|---------------------------|
| Optocoupler module 100 mA/DC            |  | OBIC 0100-5-12VDC        | 1SNA645047R0000   | 10      | 0.02<br>(0.44)            |
|   |  | OBIC 0100-24VDC          | 1SNA645021R2600   |         |                           |
|   |  | OBIC 0100-48-60VAC/DC    | 1SNA645049R1200   |         |                           |
|   |  | OBIC 0100-115-230VAC/DC  | 1SNA645022R2700   |         |                           |
| Optocoupler module 100 mA/DC            |  | OBRIC 0100-5-12VDC       | 1SNA645547R0200   | 10      | 0.02<br>(0.44)            |
|   |  | OBRIC 0100-24VDC         | 1SNA645521R2000   |         |                           |
|   |  | OBRIC 0100-48-60VAC/DC   | 1SNA645549R1400   |         |                           |
|   |  | OBRIC 0100-115-230VAC/DC | 1SNA645522R2100   |         |                           |
| Optocoupler module 2 A/DC               |  | OBOC 1000-5-12VDC        | 1SNA645050R1700   | 10      | 0.02<br>(0.44)            |
|   |  | OBOC 1000-24VDC          | 1SNA645051R0400   |         |                           |
|   |  | OBOC 1500-24VAC/DC       | 1SNA645025R2200   |         |                           |
|   |  | OBOC 1000-48-60VAC/DC    | 1SNA645053R0600   |         |                           |
|   |  | OBOC 1000-115VAC/DC      | 1SNA645054R0700   |         |                           |
|   |  | OBOC 1000-230VAC/DC      | 1SNA645026R2300   |         |                           |
| Optocoupler module 2 A/DC               |  | OBROC 1000-5-12VDC       | 1SNA645550R1100   | 10      | 0.02<br>(0.44)            |
|   |  | OBROC 1000-24VDC         | 1SNA645551R0600   |         |                           |
|   |  | OBROC 1500-24VAC/DC      | 1SNA645525R2400   |         |                           |
|   |  | OBROC 1000-48-60VAC/DC   | 1SNA645553R0000   |         |                           |
|   |  | OBROC 1000-115VAC/DC     | 1SNA645554R0100   |         |                           |
|   |  | OBROC 1000-230VAC/DC     | 1SNA645526R2500   |         |                           |
| Optocoupler module 5 A/DC               |  | OBOC 5000-24VDC          | 1SNA645 024 R2100 | 10      | 0.02<br>(0.44)            |
|   |  | OBOC 5000-115VAC/DC      | 1SNA645058R1300   |         |                           |
|   |  | OBOC 5000-230VAC/DC      | 1SNA645059R1400   |         |                           |
| Optocoupler module 5 A/DC               |  | OBROC 5000-24VDC         | 1SNA645524R2300   | 10      | 0.02<br>(0.44)            |
|   |  | OBROC 5000-115VAC/DC     | 1SNA645558R1500   |         |                           |
|   |  | OBROC 5000-230VAC/DC     | 1SNA645559R1600   |         |                           |
| Optocoupler module 1 A/AC 6 mm spacing  |  | OBOA 1000-24VDC          | 1SNA645027R2400   | 10      | 0.03<br>(0.066)           |
|   |  | OBOA 1000-48-60VAC/DC    | 1SNA645061R0600   |         |                           |
|   |  | OBOA 1000-115VAC/DC      | 1SNA645062R0700   |         |                           |
|   |  | OBOA 1000-230VAC/DC      | 1SNA645028R0500   |         |                           |
| Optocoupler module 2 A/AC 12 mm spacing |  | OBOA 2000-24VDC          | 1SNA645029R0600   | 5       | 0.03<br>(0.066)           |
| Optocoupler module 1 A/AC 6 mm spacing  |  | OBROA 1000-24VDC         | 1SNA645527R2600   | 10      | 0.03<br>(0.066)           |
|   |  | OBROA 1000-48-60VAC/DC   | 1SNA645561R0000   |         |                           |
|   |  | OBROA 1000-115VAC/DC     | 1SNA645562R0100   |         |                           |
|   |  | OBROA 1000-230VAC/DC     | 1SNA645528R0700   |         |                           |
| Optocoupler module 2 A/AC 12 mm spacing |  | OBROA 2000-24VDC         | 1SNA645529R0000   | 5       | 0.03<br>(0.066)           |

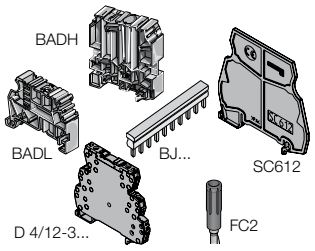

| Accessories                               | Reference code | Catalog number  | Pkg qty | Weight (1 pce)<br>kg (lb) |
|---|----------------|-----------------|---------|---------------------------|
| End section                               | BADH V0        | 011690027       | 50      |                           |
|   | BADL V0        | 039990302       | 50      |                           |
|   | BAM2 V0        | 039996701       | 50      |                           |
| Separator end section                     | SC 612         | 1SNA290474R0200 | 10      |                           |
| Divisible shunt 10 poles                  | BJ 612-10      | 1SNA290488R0100 | 10      |                           |
| Screw clamp distribution block sp. 12 mm  | D4/12-3-3      | 1SNA645031R2000 | 5       |                           |
| Spring clamp distribution block sp. 12 mm | D4/12-3R-3R    | 1SNA645531R2200 | 5       |                           |
| Test plug DIA. 2 mm                       | FC2            | 000786526       | 10      |                           |
| Marking method                            | RC65 / RC610   | see marking     |         |                           |

# R600 Optocouplers

## Connection diagrams

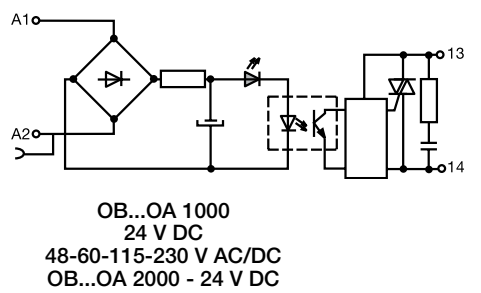
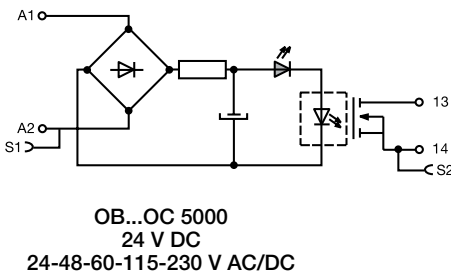
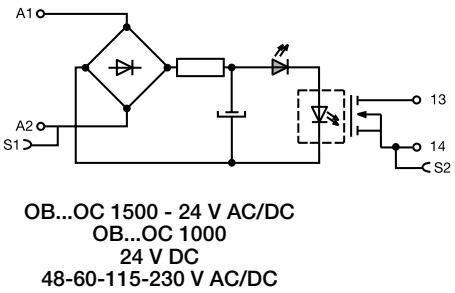
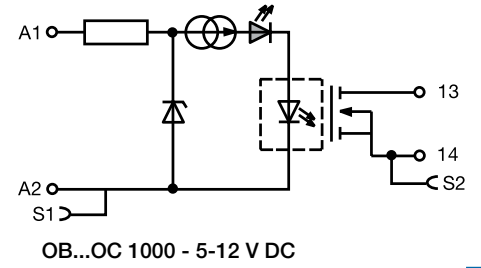
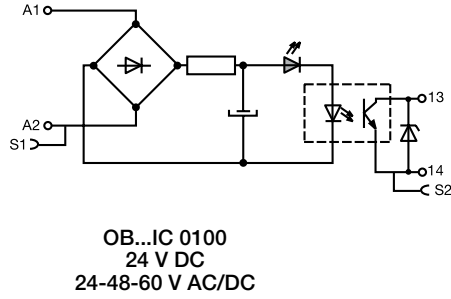
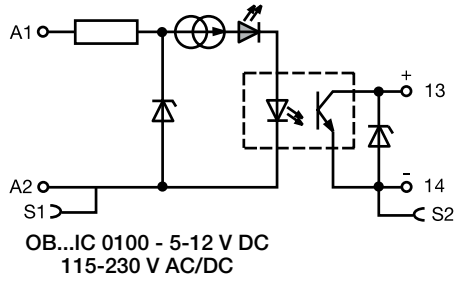





# R600 Optocouplers

## Technical data

### Technical data

Optocoupler : 5 to 58 V DC output / 100 mA - 6 mm 0.236" spacing

|   |                            | OB...IC 0100   |      |   |   |
|---|----------------------------|--|------|---|---|
| <b>Relay characteristics coil</b>                 |                            | 5 V DC - 12 V DC   |      | 24 V DC   | 48 V AC/DC   60 V AC/DC   115 V AC/DC   230 V AC/DC |
| Input voltage: +20%, -15% on DC ; 10%, -10% on AC |                            |  |      |   |   |
| Frequency   |                            |  |      |   | 50 / 60 Hz  |
| Input current AC/DC                               |                            | 5 mA   | 9 mA | 4 mA  | 4 mA   5 mA   7 mA / 16 mA   11.5 mA / 25 mA        |
| <b>6</b>  | Pull-in voltage at Is=100% | 4 V  |      | 15 V  | 25 V   60 V AC / 70 V DC                            |
| Switching time C / O                              |                            | 10 μs / 500 μs   |      |   |   |
| Operating frequency                               |                            | 1000 Hz  |      |   | 5 ms / 20 ms   5 ms / 15 ms                         |
| Permissible leakage current                       |                            |  |      |   | 20 Hz   |
| <b>Output</b>                                     |                            | 0.9 mA   | 1 mA |   | 0.9 mA   1.6 mA                                     |
| Output voltage                                    |                            |  |      |   | 4.5 to 58 V DC                                      |
| Output current min.                               |                            |  |      |   | 1 mA  |
| Output current max.                               |                            |  |      |   | 100 mA  |
| Output leakage current at U <sub>max</sub>        |                            |  |      |   | < 50 μA   |
| Residual voltage at I max and U rated             |                            | typical  |      |   | 1 V   |
|   |                            | max  |      |   | 1.3 V   |
| Frequency on inductive load                       |                            |  |      |   |   |
| Isolation Input / Output                          |                            | input / Output   |      |   | 2500 V RMS  |
| Temperature                                       |                            | storage  |      |   | -40...+80 °C  |
|   |                            | operating  |      |   | -20...+70 °C <sup>1)</sup>                          |
| <b>Other characteristics</b>                      |                            | <b>Screw clamp</b>   |      | <b>Spring clamp</b>   |   |
| Body material                                     |                            | grey   |      | UL 94 V0  |   |
| Wire size   |                            | Solid wire   |      | 0.2 - 4 mm <sup>2</sup> (24-12 AWG)   |   |
|   |                            | Stranded wire  |      | 0.22 - 2.5 mm <sup>2</sup> (24-12 AWG)  |   |
| Rated wire size                                   |                            |  |      | 2.5 mm <sup>2</sup> (12 AWG)  |   |
| Wire stripping length                             |                            |  |      | 9 mm (0.354 in)   |   |
| Recommended screwdriver                           |                            |  |      | 3.5 mm (0.137 in)   |   |
| Protection  |                            |  |      | IP20 NEMA1  |   |
| Recommended torque                                |                            |  |      | 0.4-0.6 Nm (3.5-5.3 lb.in)  |   |
| Approvals   |                            |  |      | e  us (pending for 12 V DC) ,  (pending),  , LRS ,  |   |
| Reference standards                               |                            | CEI 947-7-1 / CEI 947-1 / CEI 1131-2 (in relevant parts) / CEI 60664-1 / CEM : IRC 1000-4-2, 3, 4, 5, 6. |      |   |   |

<sup>1)</sup> Over 55°C, blocks have to be mounted on horizontal rail with 10 mm spacing between each block. For vertical rail mounting use temperature is 15°C less decreased.

### Dimensional drawings

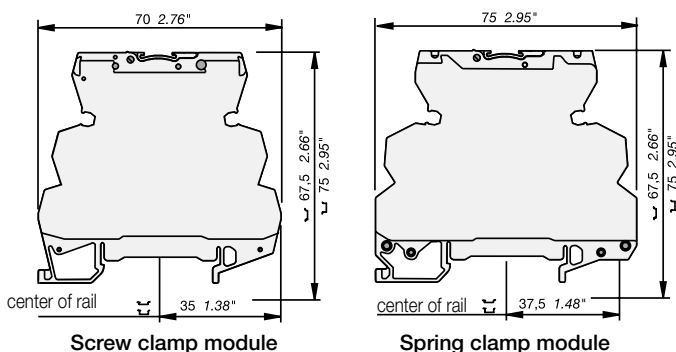

# R600 Optocouplers

## Technical data

Optocouplers  
R600 & R500 Range

### Technical data

Optocoupler : 5 to 58 V DC output / 2 A - 6 mm 0.236" spacing

|   | OB...IC 0100   |      | OB..OC<br>1500                         | OB...OC 1000 |              |                                     |                     |              |
|---|--|------|--|--------------|--------------|-------------------------------------|---------------------|--------------|
| <b>Relay characteristics coil</b>                 |  |      |  |              |              |                                     |                     |              |
| Input voltage: +20%, -15% on DC ; 10%, -10% on AC | 5 V DC - 12 V DC   |      | 24 V DC                                | 24 V AC/DC   | 48 V AC/DC   | 60 V AC/DC                          | 115 V AC/DC         | 230 V AC/DC  |
| Frequency   | 50 / 60 Hz   |      |  |              |              |                                     |                     |              |
| Input current                                     | 5 mA   | 9 mA | 4 mA                                   | 6.3 mA       | 4 mA         | 5.1 mA                              | 4.2 mA              | 4 mA         |
| Pull-in voltage at Is=100%                        | 4 V  |      | 15 V                                   | 15 V         | 27 V         |                                     | 50 V                | 80 V         |
| Switching time C / O                              | 15 $\mu$ s / 250 $\mu$ s   |      | 30 $\mu$ s / 400 $\mu$ s               | 1 ms / 7 ms  | 5 ms / 20 ms |                                     | 500 $\mu$ s / 10 ms | 1 ms / 15 ms |
| Operating frequency                               | 2000 Hz  |      | 1000 Hz                                | 60 Hz        | 20 Hz        |                                     |                     |              |
| Permissible leakage current                       | 1 mA   |      | 0.8 mA                                 | 0.9 mA       | 1 mA         |                                     | 0.3 mA              |              |
| <b>Output</b>                                     |  |      |  |              |              |                                     |                     |              |
| Output voltage                                    | 4.5 to 58 V DC   |      |  |              |              |                                     |                     |              |
| Output current min.                               | 1 mA   |      |  |              |              |                                     |                     |              |
| Output current max.                               | 2 A  |      |  |              |              |                                     |                     |              |
| Output leakage current at U <sub>max</sub>        | < 50 $\mu$ A   |      |  |              |              |                                     |                     |              |
| Redidual voltage at I max and U rated             | typical  |      | 0.1 V                                  |              |              |                                     |                     |              |
|   | max  |      | 0.5 V                                  |              |              |                                     |                     |              |
| Frequency on inductive load                       |  |      |  |              |              |                                     |                     |              |
| Isolation Input / Output                          | input / Output   |      | 2500 V RMS                             |              |              |                                     |                     |              |
| Temperature                                       | storage  |      | -40...+80 °C                           |              |              |                                     |                     |              |
|   | operating  |      | -20...+70 °C <sup>1)</sup>             |              |              |                                     |                     |              |
| <b>Other characteristics</b>                      |  |      |  |              |              |                                     |                     |              |
| Body material                                     | grey   |      | Screw clamp                            |              |              | Spring clamp                        |                     |              |
|   |  |      | UL 94 V0                               |              |              |                                     |                     |              |
| Wire size   | Solid wire   |      | 0.2 - 4 mm <sup>2</sup> (24-12 AWG)    |              |              | 0.2-2.5 mm <sup>2</sup> (24-12 AWG) |                     |              |
|   | Stranded wire  |      | 0.22 - 2.5 mm <sup>2</sup> (24-12 AWG) |              |              |                                     |                     |              |
| Rated wire size                                   | 2.5 mm <sup>2</sup> (12 AWG)   |      |  |              |              |                                     |                     |              |
| Wire stripping length                             | 9 mm (0.354 in)  |      |  |              |              |                                     |                     |              |
| Recommended screwdriver                           | 3.5 mm (0.137 in)  |      |  |              |              |                                     |                     |              |
| Protection  | IP20 NEMA1   |      |  |              |              |                                     |                     |              |
| Recommended torque                                | 0.4-0.6 Nm (3.5-5.3 lb.in)   |      |  |              |              |                                     |                     |              |
| Approvals   | UL (pending for 12 V DC) , CE (pending), LRS , CE  |      |  |              |              |                                     |                     |              |
| Reference standards                               | CEI 947-7-1 / CEI 947-1 / CEI 1131-2 (in relevant parts) / CEI 60664-1 / CEM : IRC 1000-4-2, 3, 4, 5, 6. |      |  |              |              |                                     |                     |              |

<sup>1)</sup> Over 55°C, blocks have to be mounted on horizontal rail with 10 mm spacing between each block. For vertical rail mounting use temperature is 15°C less decreased.

### Dimensional drawings

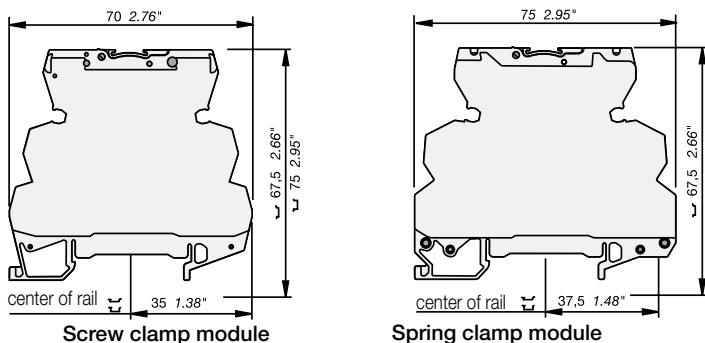

# R600 Optocouplers

## Technical data

### Technical data

Optocoupler : 5 to 58 V DC output / 5 A - 6 mm 0.236" spacing

OB... OC 5000

#### Input

|                             |                |                |             |
|-----------------------------|----------------|----------------|-------------|
| Input voltage               | 24 V DC        | 115 V AC/DC    | 230 V AC/DC |
| Frequency                   |                | 50 / 60 Hz     | 50 / 60 Hz  |
| Input current               | 5.4 mA         | 4.2 mA         | 4 mA        |
| Pull-in voltage at Is=100%  | 12 V           | 50 V           | 80 V        |
| Switching time C / O        | 30 μs / 400 μs | 500 μs / 10 ms | 1ms / 15 ms |
| Operating frequency         | 1000 Hz        | 50 Hz          | 35 Hz       |
| Permissible leakage current | 0.8 mA         | 0.3 mA         | 0.3 mA      |



#### Output

|  |                |              |
|--|----------------|--------------|
| Output voltage                             |                | 4.5- 58 V DC |
| Output current min.                        |                | 25 mA        |
| Output current max.                        |                | 1 A          |
| Output leakage current at U <sub>max</sub> |                | < 0.50 mA    |
| Residual voltage at I max and U rated      | typical        | 1 V          |
|  | max            | 1.6 V        |
| Frequency on inductive load                |                | See Note 1   |
| Isolation Input / Output                   | input / Output | 2500 V RMS   |

#### Temperature

|                     |           |                    |
|---------------------|-----------|--------------------|
| Ambient temperature | storage   | -40...+80 °C       |
|                     | operating | See derating curve |

#### Other characteristics

|                         |               |   |
|-------------------------|---------------|---|
| Body material           | grey          | UL 94 V0  |
| Wire size               | Solid wire    | 0.2 - 4 mm <sup>2</sup> (24-12 AWG)   |
|                         | Stranded wire | 0.22 - 2.5 mm <sup>2</sup> (24-12 AWG)  |
| Rated wire size         |               | 2.5 mm <sup>2</sup> (12 AWG)  |
| Wire stripping length   |               | 10 mm (0.394 in)  |
| Recommended screwdriver |               | 3.5 mm (0.137 in)   |
| Protection              |               | IP20 NEMA1  |
| Recommended torque      |               | 0.4-0.6 Nm (3.5-5.3 lb.in)  |
| Approvals               |               |  us (pending),  |
| Reference standards     |               | CEI 947-7-1 / CEI 947-1 / CEI 1131-2 (in relevant parts) / CEI 60664-1 / CEM : IRC 1000-4-2, 3, 4, 5, 6.  |

### Dimensional drawings

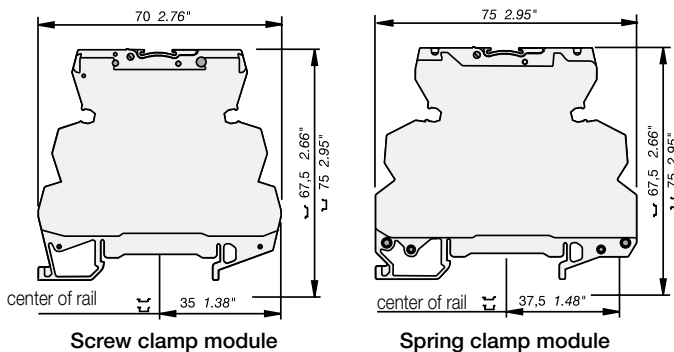







# R600 Optocouplers

## Technical data

Optocouplers  
R600 & R500 Range

### Technical data

Optocoupler : 24 to 400 V AC output / 2 A max. - 6 mm or 12 mm spacing

|   | OB...OA 1000  |  |            |                                     |                | OB...OA 2000  |
|---|---|--|------------|-------------------------------------|----------------|---------------|
| <b>Relay characteristics coil</b>                 |   |  |            |                                     |                |               |
| Input voltage: +20%, -15% on DC ; 10%, -10% on AC | 24 V DC   | 48 V AC/DC                             | 60 V AC/DC | 115 V AC/DC                         | 230 V AC/DC    | 24 V DC       |
| Frequency   | 50/60 Hz  |  |            |                                     |                |               |
| Input current                                     | 3.6 mA  | 4.3 mA                                 | 5.5 mA     | 4.15 mA                             | 4.6 mA         | 3.6 mA        |
| Pull-in voltage at Is=100%                        | 14 V  | 15 V                                   | 18 V       | 60 V                                | 135 V          | 14 V          |
| Switching time C / O                              | 150 μs / 1 ms   | 3 ms / 30 ms                           |            | 2.2 ms / 18 ms                      | 2.5 ms / 25 ms | 150 μs / 1 ms |
| Operating frequency                               | 500 Hz  | 20 Hz                                  |            | 25 Hz                               | 20 Hz          | 500 Hz        |
| Permissible leakage current                       | 1 mA  |  |            |                                     |                |               |
| <b>Output</b>                                     |   |  |            |                                     |                |               |
| Output voltage                                    | 24-58 V AC  |  |            |                                     |                |               |
| Frequency   | 50/60 Hz  |  |            |                                     |                |               |
| Output current min.                               | 25 mA   |  |            |                                     |                |               |
| Output current max.                               | 1 A   |  |            |                                     |                | 2 mA          |
| Output leakage current at U <sub>max</sub>        | < 0.50 mA   |  |            |                                     |                |               |
| Residual voltage at I max and U rated             | typical   |  |            |                                     |                | 1 V           |
|   | max   |  |            |                                     |                | 1.6 V         |
| Frequency on inductive load                       |   |  |            |                                     |                |               |
| Isolation Input / Output                          | input / Output  | 2500 V RMS                             |            |                                     |                |               |
| Temperature                                       | storage   | -40...+80 °C                           |            |                                     |                |               |
|   | operating   | -20...+70 °C <sup>1)</sup>             |            |                                     |                |               |
| <b>Other characteristics</b>                      |   |  |            |                                     |                |               |
| Body material                                     | grey  | Screw clamp                            |            | Spring clamp                        |                |               |
|   |   | UL 94 V0                               |            |                                     |                |               |
| Wire size   | Solid wire  | 0.2 - 4 mm <sup>2</sup> (24-12 AWG)    |            | 0.2-2.5 mm <sup>2</sup> (24-12 AWG) |                |               |
|   | Stranded wire   | 0.22 - 2.5 mm <sup>2</sup> (24-12 AWG) |            |                                     |                |               |
| Rated wire size                                   | 2.5 mm <sup>2</sup> (12 AWG)  |  |            |                                     |                |               |
| Wire stripping length                             | 9 mm (0.354 in)   |  |            |                                     |                |               |
| Recommended screwdriver                           | 3.5 mm (0.137 in)   |  |            |                                     |                |               |
| Protection  | IP20 NEMA1  |  |            |                                     |                |               |
| Recommended torque                                | 0.4-0.6 Nm (3.5-5.3 lb.in)  |  |            |                                     |                |               |
| Approvals   | c  us (pending for 12 V DC) ,  (pending),  , LRS ,  |  |            |                                     |                |               |
| Reference standards                               | CEI 947-7-1 / CEI 947-1 / CEI 1131-2 (in relevant parts) / CEI 60664-1 / CEM : IRC 1000-4-2, 3, 4, 5, 6.  |  |            |                                     |                |               |

<sup>1)</sup> Over 55°C, blocks have to be mounted on horizontal rail with 10 mm spacing between each block. For vertical rail mounting use temperature is 15°C less decreased.

### Dimensional drawings

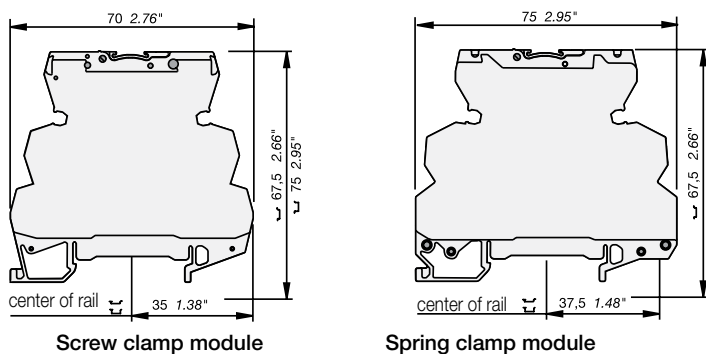

# R500 Optocouplers Selection

6

| Reference code             | Catalog number  |
|----------------------------|-----------------|
| D 2,5/5-OBIC-0030-5VDC     | 1SNA607274R1300 |
| D 2,5/5-OBIC-0030-24VDC    | 1SNA607210R1700 |
| D 2,5/5-OBIC-0030-48VDC    | 1SNA607211R0400 |
| D 2,5/5-OBIC-0030-125VDC   | 1SNA607275R1400 |
| D 2,5/5-OBIA-0030-24VAC    | 1SNA607212R0500 |
| D 2,5/5-OBIA-0030-48VAC    | 1SNA607213R0600 |
| D 2,5/5-OBIA-0030-115VAC   | 1SNA607214R0700 |
| D 2,5/5-OBIA-0030-230VAC   | 1SNA607215R0000 |
| D 2,5/5-OBOC-0100-5VDC     | 1SNA607203R1500 |
| D 2,5/5-OBOC-0100-24VDC    | 1SNA607204R1600 |
| D 2,5/5-OBOC-0100-48VDC    | 1SNA607205R1700 |
| D 2,5/5-OBOC-1000-5VDC     | 1SNA607206R1000 |
| D 2,5/5-OBOC-1000-24VDC    | 1SNA607207R1100 |
| D 2,5/5-OBOC-1000-24VAC/DC | 1SNA607250R2700 |
| D 2,5/5-OBOC-1000-48VAC/DC | 1SNA607251R1400 |
| D 2,5/5-OBOC-1000-110VAC   | 1SNA607270R2300 |
| D 2,5/5-OBOC-1000-230VAC   | 1SNA607271R1000 |
| D 2,5/5-OBOC-2000-5VDC     | 1SNA607208R2200 |
| D 2,5/5-OBOC-2000-24VDC    | 1SNA607209R2300 |
| D 2,5/5-OBOC-2000-24VAC/DC | 1SNA607255R1000 |
| D 2,5/5-OBOC-2000-48VAC/DC | 1SNA607256R1100 |
| D 2,5/5-OBOC-2000-110VAC   | 1SNA607272R1100 |
| D 2,5/5-OBOC-2000-230VAC   | 1SNA607273R1200 |
| D 2,5/5-OB0A-1000-24VDC    | 1SNA607238R1700 |
| D 2,5/5-OB0A-1000-24VAC/DC | 1SNA607240R2500 |
| D 2,5/5-OB0A-1000-48VAC/DC | 1SNA607241R1200 |
| D 2,5/5-OB0A-1000-110VAC   | 1SNA607268R2500 |
| D 2,5/5-OB0A-1000-230VAC   | 1SNA607269R2600 |

| Input voltage | 1 | 2 | 3 | 4 | 5 | 6 | 7 | 8 | 9 | 10 | 11 | 12 | 13 | 14 | 15 | 16 | 17 | 18 | 19 | 20 |
|---------------|---|---|---|---|---|---|---|---|---|----|----|----|----|----|----|----|----|----|----|----|
| 5 V DC        | ■ |   |   |   |   |   |   |   |   |    |    |    |    |    |    |    |    |    |    |    |
| 24 V DC       |   | ■ |   |   |   |   |   |   |   |    |    |    |    |    |    |    |    |    |    |    |
| 48 V DC       |   |   | ■ |   |   |   |   |   |   |    |    |    |    |    |    |    |    |    |    |    |
| 125 V DC      |   |   |   | ■ |   |   |   |   |   |    |    |    |    |    |    |    |    |    |    |    |
| 24 V AC       |   |   |   |   | ■ |   |   |   |   |    |    |    |    |    |    |    |    |    |    |    |
| 48 V AC       |   |   |   |   |   | ■ |   |   |   |    |    |    |    |    |    |    |    |    |    |    |
| 110 V AC      |   |   |   |   |   |   | ■ |   |   |    |    |    |    |    |    |    |    |    |    |    |
| 115 V AC      |   |   |   |   |   |   |   | ■ |   |    |    |    |    |    |    |    |    |    |    |    |
| 230 V AC      |   |   |   |   |   |   |   |   | ■ |    |    |    |    |    |    |    |    |    |    |    |

| Output rating | 1 | 2 | 3 | 4 | 5 | 6 | 7 | 8 | 9 | 10 | 11 | 12 | 13 | 14 | 15 | 16 | 17 | 18 | 19 | 20 |
|---------------|---|---|---|---|---|---|---|---|---|----|----|----|----|----|----|----|----|----|----|----|
| 30 mA         | ■ | ■ | ■ | ■ | ■ | ■ | ■ | ■ | ■ | ■  | ■  | ■  | ■  | ■  | ■  | ■  | ■  | ■  | ■  | ■  |
| 100 mA        |   |   |   |   |   |   |   |   | ■ | ■  | ■  | ■  | ■  | ■  | ■  | ■  | ■  | ■  | ■  | ■  |
| 2 A           |   |   |   |   |   |   |   |   |   |    |    |    |    |    |    |    |    |    |    |    |
| 1 A           |   |   |   |   |   |   |   |   |   |    |    |    |    |    |    |    |    |    |    |    |

| Output voltage | 1 | 2 | 3 | 4 | 5 | 6 | 7 | 8 | 9 | 10 | 11 | 12 | 13 | 14 | 15 | 16 | 17 | 18 | 19 | 20 |
|----------------|---|---|---|---|---|---|---|---|---|----|----|----|----|----|----|----|----|----|----|----|
| 30 V DC        |   |   |   |   |   |   |   |   |   |    |    |    |    |    |    |    |    |    |    |    |
| 58 V DC        | ■ | ■ | ■ | ■ | ■ | ■ | ■ | ■ | ■ | ■  | ■  | ■  | ■  | ■  | ■  | ■  | ■  | ■  | ■  | ■  |
| 253 V AC       |   |   |   |   |   |   |   |   |   |    |    |    |    |    |    |    |    |    |    |    |

| Type               | 1 | 2 | 3 | 4 | 5 | 6 | 7 | 8 | 9 | 10 | 11 | 12 | 13 | 14 | 15 | 16 | 17 | 18 | 19 | 20 |
|--------------------|---|---|---|---|---|---|---|---|---|----|----|----|----|----|----|----|----|----|----|----|
| input optocoupler  | ■ | ■ | ■ | ■ | ■ | ■ | ■ | ■ | ■ | ■  | ■  | ■  | ■  | ■  | ■  | ■  | ■  | ■  | ■  | ■  |
| output optocoupler |   |   |   |   |   |   |   |   |   |    |    |    |    |    |    |    |    |    |    |    |

# R500 Optocouplers Selection

Optocouplers  
R600 & R500 Range



| Description of R600 Optocoupler | Reference code             | Catalog number  | Pkg qty | Weight (1 pce) kg (lb) |
|---------------------------------|----------------------------|-----------------|---------|------------------------|
| Optocoupler module 30 mA/DC     | D 2,5/5-OBIC-0030-5VDC     | 1SNA607274R1300 | 1       | 0.032 (0.071)          |
|                                 | D 2,5/5-OBIC-0030-24VDC    | 1SNA607210R1700 |         |                        |
|                                 | D 2,5/5-OBIC-0030-48VDC    | 1SNA607211R0400 |         |                        |
|                                 | D 2,5/5-OBIC-0030-125VDC   | 1SNA607275R1400 |         |                        |
| Optocoupler module 30 mA/AC     | D 2,5/5-OBIA-0030-24VAC    | 1SNA607212R0500 | 1       | 0.032 (0.071)          |
|                                 | D 2,5/5-OBIA-0030-48VAC    | 1SNA607213R0600 |         |                        |
|                                 | D 2,5/5-OBIA-0030-115VAC   | 1SNA607214R0700 |         |                        |
|                                 | D 2,5/5-OBIA-0030-230VAC   | 1SNA607215R0000 |         |                        |
| Optocoupler module 100 mA/DC    | D 2,5/5-OBOC-0100-5VAC     | 1SNA607203R1500 | 1       | 0.032 (0.071)          |
|                                 | D 2,5/5-OBOC-0100-24VAC    | 1SNA607204R1600 |         |                        |
|                                 | D 2,5/5-OBOC-0100-48VAC    | 1SNA607205R1700 |         |                        |
| Optocoupler module 1 A/DC       | D 2,5/5-OBOC-1000-5VDC     | 1SNA607206R1000 | 1       | 0.04 (0.088)           |
|                                 | D 2,5/5-OBOC-1000-24VDC    | 1SNA607207R1100 |         |                        |
|                                 | D 2,5/5-OBOC-1000-24VAC/DC | 1SNA607250R2700 |         |                        |
|                                 | D 2,5/5-OBOC-1000-48VAC/DC | 1SNA607251R1400 |         |                        |
|                                 | D 2,5/5-OBOC-1000-110VAC   | 1SNA607270R2300 |         |                        |
|                                 | D 2,5/5-OBOC-1000-230VAC   | 1SNA607271R1000 |         |                        |
| Optocoupler module 2 A/DC       | D 2,5/5-OBOC-2000-5VDC     | 1SNA607208R2200 | 1       | 0.04 (0.088)           |
|                                 | D 2,5/5-OBOC-2000-24VDC    | 1SNA607209R2300 |         |                        |
|                                 | D 2,5/5-OBOC-2000-24VAC/DC | 1SNA607255R1000 |         |                        |
|                                 | D 2,5/5-OBOC-2000-48VAC/DC | 1SNA607256R1100 |         |                        |
|                                 | D 2,5/5-OBOC-2000-110VAC   | 1SNA607272R1100 |         |                        |
|                                 | D 2,5/5-OBOC-2000-230VAC   | 1SNA607273R1200 |         |                        |
| Optocoupler module 1 A/DC       | D 2,5/5-OBOA-1000-24VAC    | 1SNA607238R1700 | 1       | 0.032 (0.071)          |
|                                 | D 2,5/5-OBOA-1000-24VAC/DC | 1SNA607240R2500 |         |                        |
|                                 | D 2,5/5-OBOA-1000-48VAC/DC | 1SNA607241R1200 |         |                        |
|                                 | D 2,5/5-OBOA-1000-110VAC   | 1SNA607268R2500 |         |                        |
|                                 | D 2,5/5-OBOA-1000-230VAC   | 1SNA607269R2600 |         |                        |

6

BNMS P...

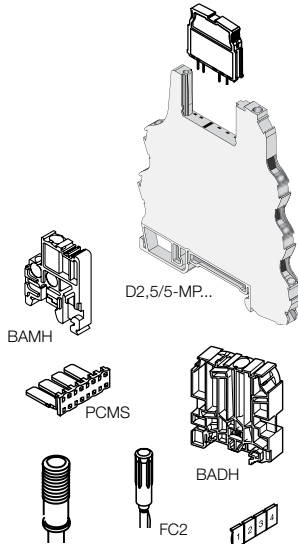

| Description of Accessories         | Reference code | Catalog number  | Pkg qty | Weight (1 pce) kg (lb) |
|------------------------------------|----------------|-----------------|---------|------------------------|
| High end stop                      | BAMH 9.1 mm    | 011483600       | 50      |                        |
|                                    | BAMH V0 9.1 mm | 019483601       |         |                        |
|                                    | BADH 12 mm     | 011690027       |         |                        |
| Comb type jumper bar 2 to 22 poles |                | consult us      |         |                        |
| Jumper bar 10 poles grey           | PCMS V0        | 1SNA205523R2200 | 8       |                        |
| Input opto base                    | D 2.5-5-MP1    | 1SNA607223R0000 | 10      | 0.028 (0.062)          |
| Plug OBIC 5 V white                | BNMS T5V-1     | 003183103       | 4       |                        |
| Plug OBIC 24 V white               | BNMS T24V-1    | 003180021       |         |                        |
| Plug OBIC 48 V white               | BNMS T48V-1    | 1SNA031801R1600 |         |                        |
| Plug OBIC 125 V white              | BNMS T125V-1   | 1SNA031845R1100 |         |                        |
| Test device blue                   | DCB (1)        | 010502821       | 10      |                        |
| Test plug DIA 2 mm                 | FC2            | 000786526       |         |                        |
| Marking method                     | RC55           | see marking     |         |                        |

## R500 Optocouplers Connection diagrams

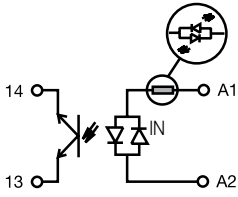

D 2.5/5-OBIC-0030

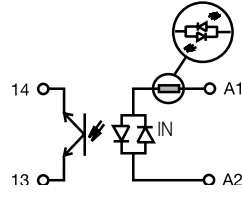

D 2.5/5-OBIA-0030

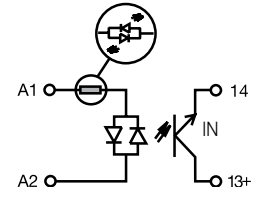

D 2.5/5-OBOC-0100

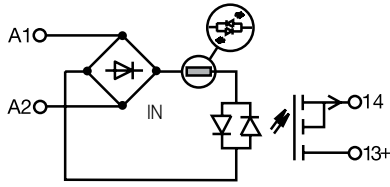

D 2.5/5-OBOC-1000  
24/48 VAC/DC  
110/230 VAC

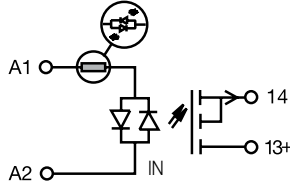

D 2.5/5-OBOC-1000 5/24 VDC

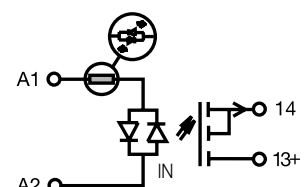

D 2.5/5-OBOC-2000

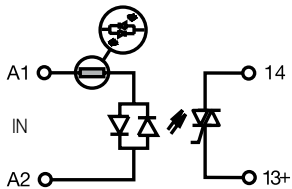

D 2.5/5-OBOA-1000

# R500 Optocouplers

## Technical data

Optocouplers  
R600 & R500 Range

### Technical data

Pluggable optocoupler : 5 to 58 V DC output / 30 mA - 5.08 mm 0.200" spacing

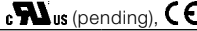
|  |                | D 2.5/5-OBIC-0030  |                    |                    |                   |
|--|----------------|--|--------------------|--------------------|-------------------|
| <b>Input</b>                               |                |  |                    |                    |                   |
| Input voltage                              |                | 4.5 V to 5.5 VDC   | 19.2 V to 27.6 VDC | 38.4 V to 55.2 VDC | 93.5 V to 140 VDC |
| Input current                              |                | 6 mA   | 5 mA               | 4.1 mA             | 3 mA              |
| Pull-in voltage at Is=100%                 |                | 3.5 V  | 12 V               | 21 V               | 50 V              |
| Switching time C / O                       |                | 20 μs / 1.3 ms   |                    |                    |                   |
| Operating frequency                        |                | 400 Hz   |                    |                    |                   |
| Permissible leakage current                |                |  | 1 mA               | 0.8 mA             |                   |
| <b>Output</b>                              |                |  |                    |                    |                   |
| Output voltage                             |                | 4.5 to 58 V DC   |                    |                    |                   |
| Output current min.                        |                | 0.5 mA   |                    |                    |                   |
| Output current max.                        |                | 30 mA  |                    |                    |                   |
| Output leakage current at U <sub>max</sub> |                | < 50 μA  |                    |                    |                   |
| Residual voltage at I max and U rated      | typical        | 2.3 V DC   |                    |                    |                   |
|  | max            | 2.7 V DC   |                    |                    |                   |
| Frequency on inductive load                |                |  |                    |                    |                   |
| Isolation Input / Output                   | input / Output | 2500 V RMS   |                    |                    |                   |
| Ambient temperature                        | storage        | -40...+80 °C   |                    |                    |                   |
|  | operating      | See derating curve   |                    |                    |                   |
| <b>Other characteristics</b>               |                |  |                    |                    |                   |
| Body material                              | grey           | UL 94 V0   |                    |                    |                   |
| Wire size                                  | Solid wire     | 0.2 - 4 mm <sup>2</sup> (24-12 AWG)  |                    |                    |                   |
|  | Stranded wire  | 0.22 - 2.5 mm <sup>2</sup> (24-12 AWG)   |                    |                    |                   |
| Rated wire size                            |                | 2.5 mm <sup>2</sup> (12 AWG)   |                    |                    |                   |
| Wire stripping length                      |                | 9 mm (0.354 in)  |                    |                    |                   |
| Recommended screwdriver                    |                | 3.5 mm (0.137 in)  |                    |                    |                   |
| Protection                                 |                | IP20 NEMA1   |                    |                    |                   |
| Recommended torque                         |                | 0.4-0.6 Nm (3.5-5.3 lb.in)   |                    |                    |                   |
| Approvals                                  |                |                      |                    |                    |                   |
| Reference standards                        |                | CEI 947-7-1 / CEI 947-1 / CEI 1131-2 (in relevant parts) / CEI 60664-1 / CEM : IRC 1000-4-2, 3, 4, 5, 6. |                    |                    |                   |

### Derating curve

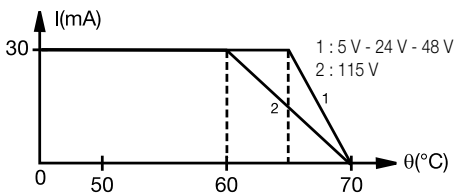

D 2.5/5-OBIC-0030

### Dimensional drawings

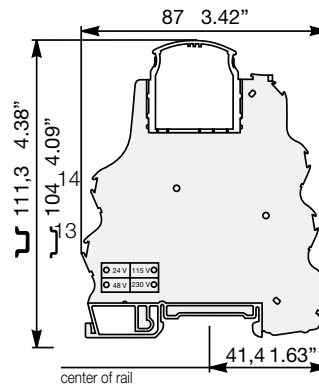

# R500 Optocouplers

## Technical data

### Technical data

Pluggable optocoupler : 5 to 58 V DC output / 30 mA - 5.08 mm 0.200" spacing

#### D 2.5/5-OBIA-0030

| Input                       | 20.4 to 26.4 V AC | 40.8 V to 52.8 V AC | 98 V to 126.5 V AC | 195.5 V to 253 V AC |
|-----------------------------|-------------------|---------------------|--------------------|---------------------|
| Input voltage               |                   |                     | 50 / 60 Hz         | 50 Hz               |
| Input current               | 8.5 mA            | 4.5 mA              | 8 mA               | 7 mA                |
| Pull-in voltage at Is=100%  | 13 V              | 22 V                | 50 V               | 95 V                |
| Switching time C / O        | 6 ms / 10 ms      |                     |                    |                     |
| Operating frequency         | 30 Hz             |                     |                    |                     |
| Permissible leakage current | 1 mA              |                     | 2 mA               |                     |

| Output                                     |                                    |
|--|------------------------------------|
| Output voltage                             | 4.5 V to 58 V DC                   |
| Output current min.                        | 0.5 mA                             |
| Output current max.                        | 30 mA                              |
| Output leakage current at U <sub>max</sub> | < 50 µA                            |
| Residual voltage at I max and U rated      | typical: 2.3 V DC<br>max: 2.7 V DC |
| Frequency on inductive load                | 2500 V RMS                         |
| Isolation Input / Output                   | input / Output                     |

### Temperature

|                     |           |                    |
|---------------------|-----------|--------------------|
| Ambient temperature | storage   | -40...+80 °C       |
|                     | operating | See derating curve |

### Other characteristics

|                         |  |  |
|-------------------------|--|--|
| Body material           | grey   | UL 94 V0                               |
| Wire size               | Solid wire   | 0.2 - 4 mm <sup>2</sup> (24-12 AWG)    |
|                         | Stranded wire  | 0.22 - 2.5 mm <sup>2</sup> (24-12 AWG) |
| Rated wire size         |  | 2.5 mm <sup>2</sup> (12 AWG)           |
| Wire stripping length   |  | 9 mm (0.354 in)                        |
| Recommended screwdriver |  | 3.5 mm (0.137 in)                      |
| Protection              |  | IP20 NEMA1                             |
| Recommended torque      |  | 0.4-0.6 Nm (3.5-5.3 lb.in)             |
| Approvals               |  | UL (pending), CE                       |
| Reference standards     | CEI 947-7-1 / CEI 947-1 / CEI 1131-2 (in relevant parts) / CEI 60664-1 / CEM : IRC 1000-4-2, 3, 4, 5, 6. |  |

### Derating curve

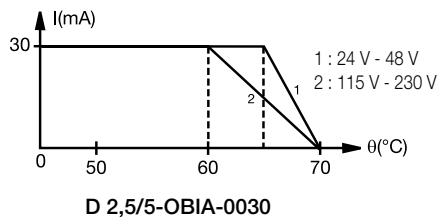

### Dimensional drawings

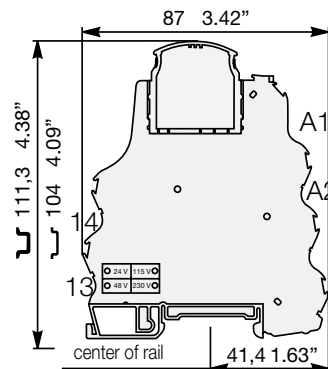

# R500 Optocouplers

## Technical data

Optocouplers  
R600 & R500 Range

### Technical data

Pluggable optocoupler : 5 to 58 V DC output / 100 mA - 5.08 mm 0.200" spacing

|   | D 2.5/5-OBIA-0100 5 V DC / 24 V DC |  | D 2.5/5-OBIA-0100 48 V DC |
|---|------------------------------------|--|---------------------------|
| <b>Input</b>                                |                                    |  |                           |
| Input voltage                               | 4.5 V to 5.5 V DC                  | 20.4 V to 28.8 V DC  | 40.8 V to 57.6 V DC       |
| Frequency                                   |                                    |  |                           |
| Input current                               | 8.5 mA                             | 4.8 mA   | 3.9 mA                    |
| Pull-in voltage at $I_s=100\%$              | 2.9 V DC                           | 16 V DC  | 26 V DC                   |
| Switching time C / O                        |                                    | 20 $\mu$ s / 1.3 ms  |                           |
| Operating frequency                         |                                    | 400 Hz   |                           |
| Permissible leakage current                 |                                    | 1 mA   |                           |
| <b>Output</b>                               |                                    |  |                           |
| Output voltage                              |                                    | 4.5 V to 58 V DC   |                           |
| Output current min.                         |                                    | 1 mA   |                           |
| Output current max.                         |                                    | 100 mA   |                           |
| Output leakage current at $U_{max}$         |                                    | < 50 $\mu$ A   |                           |
| Residual voltage at $I_{max}$ and $U$ rated | typical                            | 1 V DC   |                           |
|   | max                                | 1.3 V DC   |                           |
| Frequency on inductive load                 |                                    | See Note 1   |                           |
| Isolation Input / Output                    | input / Output                     | 2500 V RMS   |                           |
| <b>Temperature</b>                          |                                    |  |                           |
| Ambient temperature                         | storage                            | -40...+80 °C   |                           |
|   | operating                          | See derating curve   |                           |
| <b>Other characteristics</b>                |                                    |  |                           |
| Body material                               | grey                               | UL 94 V0   |                           |
| Wire size                                   | Solid wire                         | 0.2 - 4 mm <sup>2</sup> (24-12 AWG)  |                           |
|   | Stranded wire                      | 0.22 - 2.5 mm <sup>2</sup> (24-12 AWG)   |                           |
| Rated wire size                             |                                    | 2.5 mm <sup>2</sup> (12 AWG)   |                           |
| Wire stripping length                       |                                    | 9 mm (0.354 in)  |                           |
| Recommended screwdriver                     |                                    | 3.5 mm (0.137 in)  |                           |
| Protection                                  |                                    | IP20 NEMA1   |                           |
| Recommended torque                          |                                    | 0.4-0.6 Nm (3.5-5.3 lb.in)   |                           |
| Approvals                                   |                                    | cULus (pending), CE  |                           |
| Reference standards                         |                                    | CEI 947-7-1 / CEI 947-1 / CEI 1131-2 (in relevant parts) / CEI 60664-1 / CEM : IRC 1000-4-2, 3, 4, 5, 6. |                           |

**Note 1 :**

$$F_{max} = (1 - 0,007 \times U_s) / (L \times I_s^2)$$

or

$$F_{max} = (1 - 0,007 \times U_s) / (P \times \frac{L}{R})$$

- $U_s$  = Output voltage
- $I_s$  = Output current
- $L$  = Inductance of load
- $P$  = Power of load
- $R$  = Resistance of load

### Derating curve

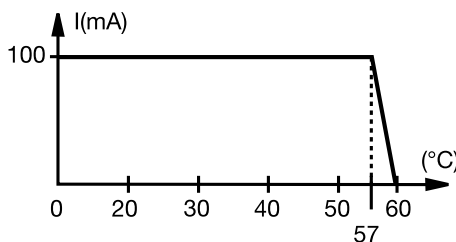

D 2.5/5-OBOC-0100 5 V DC / 24 V DC

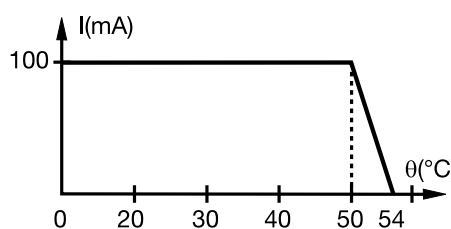

D 2.5/5-OBOC-0100 48 V DC

### Dimensional drawings

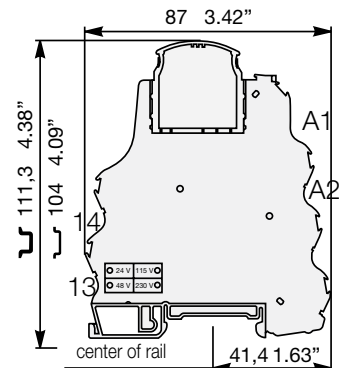

# R500 Optocouplers

## Technical data

### Technical data

Pluggable optocoupler : 5 to 58 V DC output / 1 A - 5.08 mm 0.200" spacing

6

| Input                       | D 2.5/5-OBOC-1000<br>5/24 V DC |                  | D 2.5/5-OBOC-1000 24/48 V AC/DC |                  |            |                   | D 2.5/5-OBOC-1000<br>110/230 V AC |            |
|-----------------------------|--------------------------------|------------------|---------------------------------|------------------|------------|-------------------|-----------------------------------|------------|
|                             | 5 V DC                         | 24 V DC          | 24 V AC                         | 24 V DC          | 48 V AC    | 48 V DC           | 110 V AC                          | 230 V AC   |
| Input voltage               | 4.5 - 5.5 V DC                 | 20.4 - 28.8 V DC | 24 ± 10 %                       | 20.4 - 28.8 V DC | 48 ± 10 %  | 40.8 to 57.6 V DC | 110 ± 10 %                        | 230 ± 10 % |
| Frequency                   |                                |                  | 50 / 60 Hz                      |                  | 50 / 60 Hz |                   | 50 / 60 Hz                        | 50 / 60 Hz |
| Input current               | 12.3 mA                        | 6.7 mA           | 10.5 mA                         | 8 mA             | 6.8 mA     | 5.8 mA            | 8.5 mA                            | 7.5 mA     |
| Pull-in voltage at Is=100%  | 3.5 V DC                       | 10 V DC          |                                 |                  |            |                   |                                   |            |
| Switching time C / O        | 20 / 250 µs                    | 50 / 350 µs      | 15 / 13 ms                      | 5 / 13 ms        | 15 / 15 ms | 6 / 25 ms         | 15 / 15 ms                        | 15 / 15 ms |
| Operating frequency         | 2000 Hz                        | 1500 Hz          |                                 |                  |            | 20 Hz             |                                   |            |
| Permissible leakage current |                                |                  |                                 |                  |            |                   |                                   |            |

### Output

|  |                |                  |
|--|----------------|------------------|
| Output voltage                             |                | 4.5 V to 58 V DC |
| Output current min.                        |                | 1 mA             |
| Output current max.                        |                | 1 A              |
| Output leakage current at U <sub>max</sub> |                | < 50 µA          |
| Residual voltage at I max and U rated      | typical        | 0.1 V DC         |
|  | max            | 0.5 V DC         |
| Frequency on inductive load                |                | See Note 1       |
| Isolation Input / Output                   | input / Output | 2500 V RMS       |

### Temperature

|                     |           |                    |
|---------------------|-----------|--------------------|
| Ambient temperature | storage   | -40...+80 °C       |
|                     | operating | See derating curve |

### Other characteristics

|                         |               |  |
|-------------------------|---------------|--|
| Body material           | grey          | UL 94 V0   |
| Wire size               | Solid wire    | 0.2 - 4 mm <sup>2</sup> (24-12 AWG)  |
|                         | Stranded wire | 0.22 - 2.5 mm <sup>2</sup> (24-12 AWG)   |
| Rated wire size         |               | 2.5 mm <sup>2</sup> (12 AWG)   |
| Wire stripping length   |               | 10 mm (0.394 in)   |
| Recommended screwdriver |               | 3.5 mm (0.137 in)  |
| Protection              |               | IP20 NEMA1   |
| Recommended torque      |               | 0.4-0.6 Nm (3.5-5.3 lb.in)   |
| Approvals               |               | us (pending), CE   |
| Reference standards     |               | CEI 947-7-1 / CEI 947-1 / CEI 1131-2 (in relevant parts) / CEI 60664-1 / CEM : IRC 1000-4-2, 3, 4, 5, 6. |

#### Note 1 :

$$F_{max} = (1 - 0.007 \times U_s) / (L \times I_s^2)$$

or

$$F_{max} = (1 - 0.007 \times U_s) / (P \times \frac{L}{R})$$

U<sub>s</sub> = Output voltage  
I<sub>s</sub> = Output current  
L = Inductance of load  
P = Power of load  
R = Resistance of load

### Derating curve

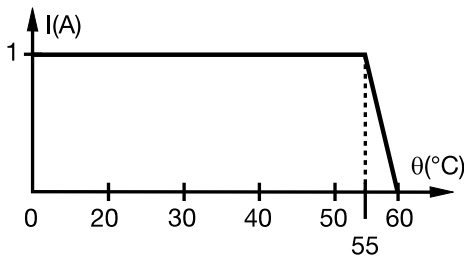

### Dimensional drawings

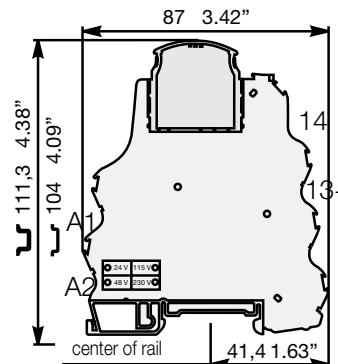



# R500 Optocouplers

## Technical data

### Technical data

Pluggable optocoupler : 5 to 30 V DC output / 2 A - 5.08 mm 0.200" spacing

|                             | D 2.5/5-OBOC-2000<br>5/24 V DC |                  | D 2.5/5-OBOC-2000 24/48 V AC/DC |                  |            |                   | D 2.5/5-OBOC-2000<br>110/230 V AC |            |
|-----------------------------|--------------------------------|------------------|---------------------------------|------------------|------------|-------------------|-----------------------------------|------------|
|                             | 5 V DC                         | 24 V DC          | 24 V AC                         | 24 V DC          | 48 V AC    | 48 V DC           | 110 V AC                          | 230 V AC   |
| Input voltage               | 4.5 - 5.5 V DC                 | 20.4 - 28.8 V DC | 24 ± 10 %                       | 20.4 - 28.8 V DC | 48 ± 10 %  | 40.8 to 57.6 V DC | 110 ± 10 %                        | 230 ± 10 % |
| Frequency                   |                                |                  | 50 / 60 Hz                      |                  | 50 / 60 Hz |                   | 50 / 60 Hz                        | 50 / 60 Hz |
| Input current               | 12.3 mA                        | 6.7 mA           | 10.5 mA                         | 8 mA             | 6.8 mA     | 5.8 mA            | 8.5 mA                            | 7.5 mA     |
| Pull-in voltage at Is=100%  | 3.5 V DC                       | 10 V DC          |                                 |                  |            |                   |                                   |            |
| Switching time C / O        | 20 / 250 µs                    | 50 / 350 µs      | 15 / 13 ms                      | 5 / 13 ms        | 15 / 15 ms | 6 / 25 ms         | 15 / 15 ms                        | 15 / 15 ms |
| Operating frequency         | 2000 Hz                        | 1500 Hz          |                                 |                  | 20 Hz      |                   |                                   |            |
| Permissible leakage current |                                |                  |                                 |                  |            |                   |                                   |            |

### Output

|  |                  |            |
|--|------------------|------------|
| Output voltage                             | 4.5 V to 58 V DC |            |
| Output current min.                        | 1 mA             |            |
| Output current max.                        | 2 A              |            |
| Output leakage current at U <sub>max</sub> | < 50 µA          |            |
| Residual voltage at I max and U rated      | typical          | 0.1 V DC   |
|  | max              | 0.5 V DC   |
| Frequency on inductive load                | See Note 1       |            |
| Isolation Input / Output                   | input / Output   | 2500 V RMS |

### Temperature

|                     |           |                    |
|---------------------|-----------|--------------------|
| Ambient temperature | storage   | -40...+80 °C       |
|                     | operating | See derating curve |

### Other characteristics

|                         |  |  |
|-------------------------|--|--|
| Body material           | grey   | UL 94 V0                               |
| Wire size               | Solid wire   | 0.2 - 4 mm <sup>2</sup> (24-12 AWG)    |
|                         | Stranded wire  | 0.22 - 2.5 mm <sup>2</sup> (24-12 AWG) |
| Rated wire size         |  | 2.5 mm <sup>2</sup> (12 AWG)           |
| Wire stripping length   |  | 10 mm (0.394 in)                       |
| Recommended screwdriver |  | 3.5 mm (0.137 in)                      |
| Protection              |  | IP20 NEMA1                             |
| Recommended torque      |  | 0.4-0.6 Nm (3.5-5.3 lb.in)             |
| Approvals               |  | us (pending), CE                       |
| Reference standards     | CEI 947-7-1 / CEI 947-1 / CEI 1131-2 (in relevant parts) / CEI 60664-1 / CEM : IRC 1000-4-2, 3, 4, 5, 6. |  |

#### Note 1 :

$$F_{max} = (1 - 0,012 \times U_s) / (L \times I_s^2)$$

or

$$F_{max} = (1 - 0,012 \times U_s) / (P \times \frac{L}{R})$$

U<sub>s</sub> = Output voltage  
I<sub>s</sub> = Output current  
L = Inductance of load  
P = Power of load  
R = Resistance of load

### Derating curve

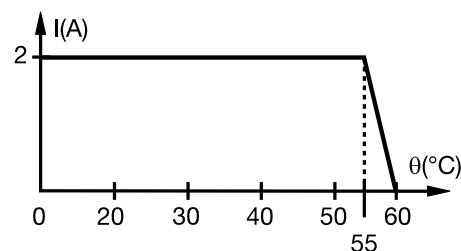

### Dimensional drawings

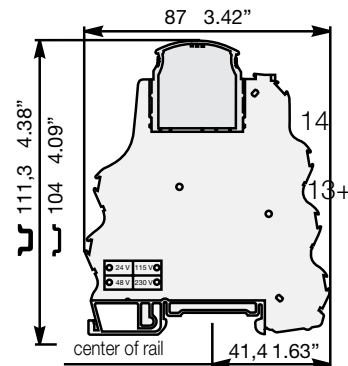

# R500 Optocouplers

## Technical data

### Technical data

Pluggable optocoupler : 24 to 253 V AC output / 1 A - 5.08 mm 0.200" spacing

|                             | D 2.5/5-...<br>24 V DC | D 2.5/5-OBOA-1000 24 V AC/DC - 48 V AC/DC |                  |            |                  | D 2.5/5-OBOA-1000 110 V<br>AC - 230 V AC |            |
|-----------------------------|------------------------|---|------------------|------------|------------------|--|------------|
| Input                       | 24 V DC                | 24 V AC                                   | 24 V DC          | 48 V AC    | 48 V DC          | 110 V AC                                 | 230 V AC   |
| Input voltage               | 20.4 - 28.8 V DC       | 24 ± 10 %                                 | 20.6 - 28.8 V DC | 48 ± 10 %  | 40.8 - 57.6 V DC | 110 ± 10 %                               | 230 ± 10 % |
| Frequency                   |                        | 50 / 60 Hz                                |                  | 50 / 60 Hz |                  | 50 / 60 Hz                               | 50 / 60 Hz |
| Input current               | 4 mA                   | 10 mA                                     | 7 mA             | 6 mA       | 5 mA             | 8 mA                                     | 7.5 mA     |
| Pull-in voltage at Is=100%  |                        |   |                  |            |                  |  |            |
| Switching time C / O        | 10/20 ms               | 20/20 ms                                  | 10/20 ms         | 20/20 ms   | 10/20 ms         | 20/20 ms                                 | 20/20 ms   |
| Operating frequency         | 15 Hz                  |   |                  |            |                  |  |            |
| Permissible leakage current |                        |   |                  |            |                  |  |            |

| Output                                     | 24-253 V AC - 50/60 Hz |            |  |  |  |  |  |  |
|--|------------------------|------------|--|--|--|--|--|--|
| Output voltage                             | 24-253 V AC - 50/60 Hz |            |  |  |  |  |  |  |
| Output current min.                        | 25 mA                  |            |  |  |  |  |  |  |
| Output current max.                        | 1 A                    |            |  |  |  |  |  |  |
| Output leakage current at U <sub>max</sub> | < 0.50 mA              |            |  |  |  |  |  |  |
| Residual voltage at I max and U rated      | typical                | 1 V        |  |  |  |  |  |  |
|  | max                    | 1.6 V      |  |  |  |  |  |  |
| Frequency on inductive load                | See Note 1             |            |  |  |  |  |  |  |
| Isolation Input / Output                   | input / Output         | 2500 V RMS |  |  |  |  |  |  |

| Temperature         |           |                    |
|---------------------|-----------|--------------------|
| Ambient temperature | storage   | -40...+80 °C       |
|                     | operating | See derating curve |

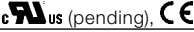
| Other characteristics   |  |  |
|-------------------------|--|--|
| Body material           | grey   | UL 94 V0                               |
| Wire size               | Solid wire   | 0.2 - 4 mm <sup>2</sup> (24-12 AWG)    |
|                         | Stranded wire  | 0.22 - 2.5 mm <sup>2</sup> (24-12 AWG) |
| Rated wire size         | 2.5 mm <sup>2</sup> (12 AWG)   |  |
| Wire stripping length   | 10 mm (0.394 in)   |  |
| Recommended screwdriver | 3.5 mm (0.137 in)  |  |
| Protection              | IP20 NEMA1   |  |
| Recommended torque      | 0.4-0.6 Nm (3.5-5.3 lb.in)   |  |
| Approvals               |                      |  |
| Reference standards     | CEI 947-7-1 / CEI 947-1 / CEI 1131-2 (in relevant parts) / CEI 60664-1 / CEM : IRC 1000-4-2, 3, 4, 5, 6. |  |

**Note 1 :**  
 $F_{max} = (1 - 0.012 \times U_s) / (L \times I_s^2)$   
 or  
 $F_{max} = (1 - 0.012 \times U_s) / (P \times \frac{L}{R})$

$U_s$  = Output voltage  
 $I_s$  = Output current  
 $L$  = Inductance of load  
 $P$  = Power of load  
 $R$  = Resistance of load

### Derating curve

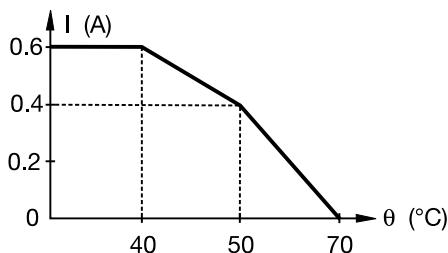

### Dimensional drawings

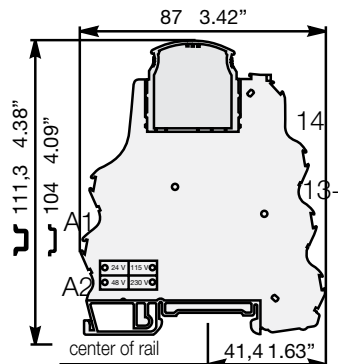



## Accessories

Interface relays & optocouplers

# Terminal blocks component holder

Base for pluggable plug  
R500 Series

DIN 3

|          |  |               |      |    |           |
|----------|--|---------------|------|----|-----------|
| End stop |  | th. 9 mm      | BADL | V0 | 039990302 |
| End stop |  | th. 9 mm      | BAM2 | V0 | 039996701 |
| Rail     |  | 35 x 7.5 x 1  | PR30 |    | 017322005 |
| Rail     |  | 35 x 15 x 2.3 | PR4  |    | 016850012 |
| Rail     |  | 35 x 15 x 1.5 | PR5  |    | 016870022 |

## D 2.5/5-MP

Spacing 5.08 mm (.200")

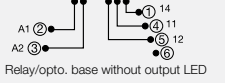
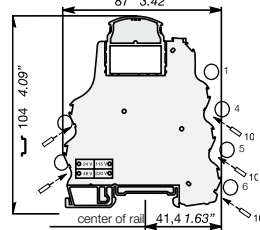

Relay/opto. base without output LED

## D 2.5/5-MP1

Spacing 5.08 mm (.200")

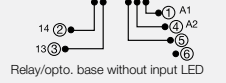
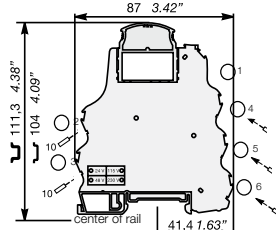

Relay/opto. base without input LED

## D 2.5/5-MP...

Spacing 5.08 mm (.200")

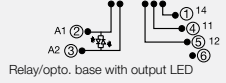
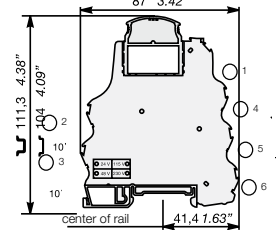

Relay/opto. base with output LED

## Observations

Terminal blocks are delivered without plugs.

Max. working temperature  
version without LED : 100°C  
version with LED : 85°C  
Contact resistance : < 5 mΩ

|  |  |  |  |  |  |
|--|--|--|--|--|--|
|  |  |  |  |  |  |
|--|--|--|--|--|--|

| Ref. Code  | Catalog No.            | Ref. Code   | Catalog No.            | Ref. Code           | Catalog No.            |
|------------|------------------------|-------------|------------------------|---------------------|------------------------|
| Grey V0    | Order plugs separately | Grey V0     | Order plugs separately | Grey V0             | Order plugs separately |
| D 2.5/5-MP | 1SNA607224R0100        | D 2.5/5-MP1 | 1SNA607223R0000        | D 2.5/5-MP-24VDC    | 1SNA607222R0700        |
|            |                        |             |                        | D 2.5/5-MP-24VAC/DC | 1SNA607260R2100        |
|            |                        |             |                        | D 2.5/5-MP-48VAC/DC | 1SNA607261R1600        |
|            |                        |             |                        | D 2.5/5-MP-110VAC   | 1SNA607266R1300        |
|            |                        |             |                        | D 2.5/5-MP-230VAC   | 1SNA607267R1400        |

## Characteristics

|                         |                   |               | IEC                        | UL/CSA pending | IEC                        | UL/CSA pending | IEC                        | UL/CSA pending |
|-------------------------|-------------------|---------------|----------------------------|----------------|----------------------------|----------------|----------------------------|----------------|
| Wire size               | Compression clamp | Solid wire    | 0.2-4 mm <sup>2</sup>      | 24-12 AWG      | 0.2-4 mm <sup>2</sup>      | 24-12 AWG      | 0.2-4 mm <sup>2</sup>      | 24-12 AWG      |
|                         |                   | Stranded wire | 0.22-2.5 mm <sup>2</sup>   | 24-12 AWG      | 0.22-2.5 mm <sup>2</sup>   | 24-12 AWG      | 0.22-2.5 mm <sup>2</sup>   | 24-12 AWG      |
| Voltage                 | Rated             |               | 320 V                      | 300 V          | 320 V                      | 300 V          | 320 V                      | 300 V          |
|                         | Pulse             |               | 4 kV                       |                | 4 kV                       |                | 4 kV                       |                |
|                         | Pollution degree  |               | 3                          |                | 3                          |                | 3                          |                |
| Current                 | Rated             |               | 6 A                        | 6 A            | 6 A                        | 6 A            | 6 A                        |                |
| Wire size               | Rated / Gauge     |               | 2.5 mm <sup>2</sup>        | 12 AWG         | 2.5 mm <sup>2</sup>        | 12 AWG         | 2.5 mm <sup>2</sup>        | 12 AWG         |
| Wire stripping length   |                   |               | 10 mm / .394"              |                | 10 mm / .394"              |                | 10 mm / .394"              |                |
| Recommended screwdriver |                   |               | 3.5 mm / .137"             |                | 3.5 mm / .137"             |                | 3.5 mm / .137"             |                |
| Recommended torque      |                   |               | 0.4-0.6 Nm / 3.5-5.3 lb.in |                | 0.4-0.6 Nm / 3.5-5.3 lb.in |                | 0.4-0.6 Nm / 3.5-5.3 lb.in |                |
| Protection              |                   |               | IP 20 / NEMA1              |                | IP 20 / NEMA1              |                | IP 20 / NEMA1              |                |

## Accessories

|                                     | Ref. Code      | Catalog No.           | Ref. Code      | Catalog No.            | Ref. Code     | Catalog No.            |
|-------------------------------------|----------------|-----------------------|----------------|------------------------|---------------|------------------------|
| 1 Test device                       | DCB (1)        | blue 010502821        | DCB (1)        | blue 010502821         | DCB (1)       | blue 1SNA105028R2100   |
| 2 Test plug                         | FC2            | DIA. 2 000786526      | FC2            | DIA. 2 010502821       | FC2           | DIA. 2 1SNA007865R2600 |
| 3 Relay plug 1 SPDT 10 mA/6 A       | BNMS R24V-1    | beige 1SNA031820R1400 | BNMS R24V-1    | beige 000786526        | BNMS R24V-1   | beige 1SNA031820R1400  |
| 1 SPDT 1 mA/6 A                     | BNMS R24V-2    | beige 1SNA031847R1300 | BNMS R24V-2    | beige 1SNA031847R1300  | BNMS R24V-2   | beige 1SNA031847R1300  |
| 4 Input optocoupler plug 5 V DC     |                |                       | BNMS T5V-1     | white 003183103        |               |                        |
| 24 V DC                             |                |                       | BNMS T24V-1    | white 1SNA031848R2400  |               |                        |
| 24 V DC                             |                |                       | BNMS T24V-2    | white 003180021        |               |                        |
| 48 V DC                             |                |                       | BNMS T48V-1    | white 1SNA031801R1600  |               |                        |
| 125 V DC                            |                |                       | BNMS T125V-1   | white 1SNA031845R1100  |               |                        |
| 24 V AC                             |                |                       | BNMS T24V-1    | yellow 003180217       |               |                        |
| 48 V AC                             |                |                       | BNMS T48V-1    | yellow 1SNA031803R1000 |               |                        |
| 115 V AC                            |                |                       | BNMS T115V-1   | yellow 003180411       |               |                        |
| 230 V AC                            |                |                       | BNMS T230V-1   | yellow 1SNA031805R1200 |               |                        |
| 5 Output optocoupler 24 V DC/100 mA | BNMS N24V-3    | red 1SNA031807R1400   | BNMS N24V-3    | red 1SNA031807R1400    | BNMS N24V-3   | red 1SNA031807R1400    |
| 24 V DC/100 mA                      | BNMS P24V-3    | red 1SNA031810R1200   | BNMS P24V-3    | red 1SNA031810R1200    | BNMS P24V-3   | red 1SNA031810R1200    |
| 24 V DC/2 A                         | BNMS N24V-1    | red 1SNA031813R0100   | BNMS N24V-1    | red 1SNA031813R0100    | BNMS N24V-1   | red 1SNA031813R0100    |
| 24 V DC/2 A                         | BNMS P24V-1    | red 1SNA031815R0300   | BNMS P24V-1    | red 1SNA031815R0300    | BNMS P24V-1   | red 1SNA031815R0300    |
| 24 V DC/1 A                         | BNMS N24V-2    | red 1SNA031817R0500   | BNMS N24V-2    | red 1SNA031817R0500    | BNMS N24V-2   | red 1SNA031817R0500    |
| 24 V DC/1 A                         | BNMS P24V-2    | red 1SNA031819R1700   | BNMS P24V-2    | red 1SNA031819R1700    | BNMS P24V-2   | red 1SNA031819R1700    |
| 24 V DC/1 A                         | BNMS A24V-4    | black 003183913       | BNMS A24V-4    | black 003183913        | BNMS A24V-4   | black 003183913        |
| 5 Output optocoupler 5 V DC/100 mA  | BNMS N5V-3     | red 1SNA031806R1300   | BNMS N5V-3     | red 1SNA031806R1300    |               |                        |
| 5 V DC/100 mA                       | BNMS P5V-3     | red 1SNA031809R2600   | BNMS P5V-3     | red 1SNA031809R2600    |               |                        |
| 48 V DC/100 mA                      | BNMS N48V-3    | red 1SNA031808R2500   | BNMS N48V-3    | red 1SNA031808R2500    |               |                        |
| 48 V DC/100 mA                      | BNMS P48V-3    | red 1SNA031811R0700   | BNMS P48V-3    | red 1SNA031811R0700    |               |                        |
| 5 V DC/2 A                          | BNMS N5V-1     | red 1SNA031812R0000   | BNMS N5V-1     | red 1SNA031812R0000    |               |                        |
| 5 V DC/2 A                          | BNMS P5V-1     | red 1SNA031814R0200   | BNMS P5V-1     | red 1SNA031814R0200    |               |                        |
| 5 V DC/1 A                          | BNMS N5V-2     | red 1SNA031816R0400   | BNMS N5V-2     | red 1SNA031816R0400    |               |                        |
| 5 V DC/1 A                          | BNMS P5V-2     | red 1SNA031818R1600   | BNMS P5V-2     | red 1SNA031818R1600    |               |                        |
| 7 Fuse plug 125 V/125 mA            | BNMS F125mA-1  | grey 003182101        | BNMS F125mA-1  | grey 003182101         | BNMS F125mA-1 | grey 003182101         |
| 125 V/500 mA                        | BNMS F500mA-1  | grey 003183812        | BNMS F500mA-1  | grey 003183812         | BNMS F500mA-1 | grey 003183812         |
| 125 V/2 A                           | BNMS F2A-1     | grey 003182202        | BNMS F2A-1     | grey 003182202         | BNMS F2A-1    | grey 003182202         |
| 125 V/5 A                           | BNMS F5A-1     | grey 003182303        | BNMS F5A-1     | grey 003182303         | BNMS F5A-1    | grey 003182303         |
| 250 V/125 mA                        | BNMS F125mA-2  | grey 1SNA031824R0400  | BNMS F125mA-2  | grey 1SNA031824R0400   | BNMS F125mA-2 | grey 1SNA031824R0400   |
| 250 V/2 A                           | BNMS F2A-2     | grey 003182505        | BNMS F2A-2     | grey 003182505         | BNMS F2A-2    | grey 003182505         |
| 250 V/5 A                           | BNMS F5A-2     | grey 1SNA031826R0600  | BNMS F5A-2     | grey 1SNA031826R0600   | BNMS F5A-2    | grey 1SNA031826R0600   |
| 125 V/125 mA                        | BNMS F125mA-3  | grey 003182707        | BNMS F125mA-3  | grey 003182707         | BNMS F125mA-3 | grey 1SNA031827R0700   |
| 250 V/125 mA                        | BNMS F125mA-4  | grey 003182810        | BNMS F125mA-4  | grey 003182810         | BNMS F125mA-4 | grey 1SNA031828R1000   |
| 125 V/2 A                           | BNMS F2A-7     | grey 1SNA031849R2500  | BNMS F2A-7     | grey 1SNA031849R2500   |               |                        |
| 8 Strap plug                        | BNMS ST1       | grey 003182911        | BNMS ST1       | grey 003182911         | BNMS ST1      | grey 003182911         |
|                                     | BNMS ST2       | grey 003183016        | BNMS ST2       | grey 003183016         |               |                        |
| 9 Converter plug 0-20 mA/0-10 V     | BNMS CAI/U-500 | grey 1SNA031832R0400  | BNMS CAI/U-500 | grey 1SNA031832R0400   |               |                        |
| 4-20 mA/2-10 V                      | BNMS CAI/U-500 | grey 1SNA031832R0400  | BNMS CAI/U-500 | grey 1SNA031832R0400   |               |                        |
| 0-20 mA/0-5 V                       | BNMS CAI/U-250 | grey 1SNA031833R0500  | BNMS CAI/U-250 | grey 1SNA031833R0500   |               |                        |
| 4-20 mA/1-5 V                       | BNMS CAI/U-250 | 1SNA031833R0500       | BNMS CAI/U-250 | 1SNA031833R0500        |               |                        |
| 10 Comb type jumper bar 10 poles    | PCMS V0 (2)    | 1SNA205523R2200       | PCMS V0 (2)    | 1SNA205523R2200        | PCMS V0 (2)   | 1SNA205523R2200        |
| R See section on marking            | RC 55          |                       | RC 55          |                        | RC 55         |                        |

(1) Solely on the top stage. (2) Comb type jumper bar from 2 to 22 poles, see accessories.



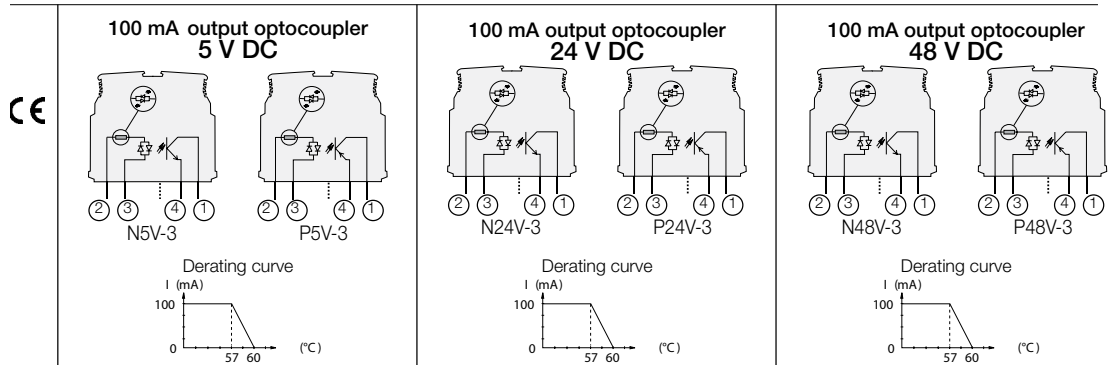
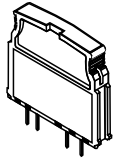

| Part numbers | Ref. Code  | Cat. No.        | Ref. Code   | Cat. No.        | Type        | Cat. No.        |
|--------------|------------|-----------------|-------------|-----------------|-------------|-----------------|
|              | BNMS N5V-3 | 1SNA031806R1300 | BNMS N24V-3 | 1SNA031807R1400 | BNMS N48V-3 | 1SNA031808R2500 |
|              | BNMS P5V-3 | 1SNA031809R2600 | BNMS P24V-3 | 1SNA031810R1200 | BNMS P48V-3 | 1SNA031811R0700 |

## 6 Characteristics

| INPUT   |                   |                     |                     |  |                     |  |
|---|-------------------|---------------------|---------------------|--|---------------------|--|
| Voltage                                       | 4.5 V to 5.5 V DC |                     | 20.4 V to 28.8 V DC |  | 40.8 V to 57.6 V DC |  |
| Max. current                                  | 8.5 mA            |                     | 4.8 mA              |  | 3.9 mA              |  |
| Typical triggering threshold at $I_s = 100\%$ | 2.9 V DC          |                     | 16 V DC             |  | 26 V DC             |  |
| Switching time                                | C/O               | 20 $\mu$ s / 1.3 ms | 20 $\mu$ s / 1.3 ms |  | 20 $\mu$ s / 1.3 ms |  |
| Leakage current                               | 1 mA              |                     | 1 mA                |  | 1 mA                |  |
| OUTPUT  |                   |                     |                     |  |                     |  |
| Max. voltage / Max. current                   | 58 V / 100 mA     |                     | 58 V / 100 mA       |  | 58 V / 100 mA       |  |
| Residual voltage max. I and rated U           |                   |                     |                     |  |                     |  |
| standard U                                    | 1 V DC            |                     | 1 V DC              |  | 1 V DC              |  |
| max.  | 1.3 V DC          |                     | 1.3 V DC            |  | 1.3 V DC            |  |
| Frequency on inductive load                   | See Note 1        |                     | See Note 1          |  | See Note 1          |  |
| Input / Output isolation                      | 2,5 kV            |                     | 2,5 kV              |  | 2,5 kV              |  |
| TEMPERATURE                                   |                   |                     |                     |  |                     |  |
| Storage                                       | - 30°C to + 80°C  |                     | - 30°C to + 80°C    |  | - 30°C to + 80°C    |  |
| Operating                                     | - 20°C to + 60°C  |                     | - 20°C to + 60°C    |  | - 20°C to + 60°C    |  |

## MOS output optocoupler plugs

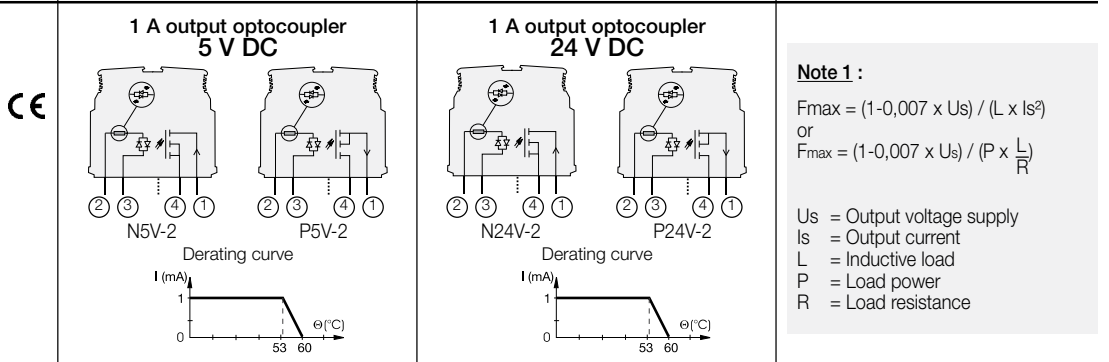
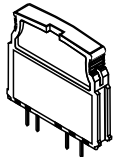

**Note 1 :**  
 $F_{max} = (1 - 0,007 \times U_s) / (L \times I_s^2)$   
 or  
 $F_{max} = (1 - 0,007 \times U_s) / (P \times \frac{L}{R})$

$U_s$  = Output voltage supply  
 $I_s$  = Output current  
 $L$  = Inductive load  
 $P$  = Load power  
 $R$  = Load resistance

| Part numbers | Ref. Code  | Cat. No.        | Ref. Code   | Cat. No.        |
|--------------|------------|-----------------|-------------|-----------------|
|              | BNMS N5V-2 | 1SNA031816R0400 | BNMS N24V-2 | 1SNA031817R0500 |
|              | BNMS P5V-2 | 1SNA031818R1600 |             |                 |

| Characteristics                             |                   |                          |                          |  |
|---|-------------------|--------------------------|--------------------------|--|
| INPUT                                       |                   |                          |                          |  |
| Voltage                                     | 4.5 V to 5.5 V DC |                          | 20.4 V to 28.8 V DC      |  |
| Max. current                                | 12.5 mA           |                          | 6.7 mA                   |  |
| Typical triggering threshold at $I_s=100\%$ | 3.5 V DC          |                          | 10 V DC                  |  |
| Switching time                              | C/O               | 20 $\mu$ s / 250 $\mu$ s | 50 $\mu$ s / 350 $\mu$ s |  |
| Leakage current                             | 1 mA              |                          | 1 mA                     |  |
| OUTPUT                                      |                   |                          |                          |  |
| Max. voltage / Max. current                 | 58 V / See graphs |                          | 58 V / See graphs        |  |
| Residual voltage max. I and rated U         |                   |                          |                          |  |
| standard U                                  | 1 V DC            |                          | 1 V DC                   |  |
| max.  | 1.3 V DC          |                          | 1.3 V DC                 |  |
| Frequency on inductive load                 | See Note 1        |                          | See Note 1               |  |
| Input / Output isolation                    | 2,5 kV            |                          | 2,5 kV                   |  |
| TEMPERATURE                                 |                   |                          |                          |  |
| Storage                                     | - 30°C to + 80°C  |                          | - 30°C to + 80°C         |  |
| Operating                                   | - 20°C to + 60°C  |                          | - 20°C to + 60°C         |  |

## MOS output optocoupler plug

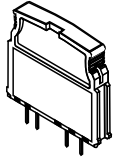

### 2 A output optocoupler 5 V DC

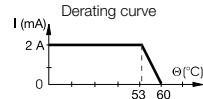
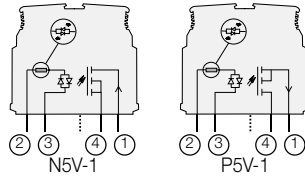

### 2 A output optocoupler 24 V DC

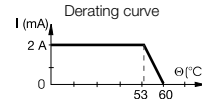
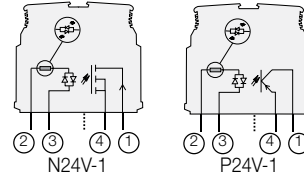

#### Note 2 :

$$F_{max} = (1 - 0.012 \times U_s) / (L \times I_s^2)$$

or

$$F_{max} = (1 - 0.012 \times U_s) / (P \times \frac{L}{R})$$

$U_s$  = Output voltage supply  
 $I_s$  = Output current  
 $L$  = Inductive load  
 $P$  = Load power  
 $R$  = Load resistance

#### Part numbers

| Ref. Code  | Cat. No.        | Ref. Code   | Cat. No.  |
|------------|-----------------|-------------|-----------|
| BNMS N5V-1 | 1SNA031812R0000 | BNMS N24V-1 | 003181301 |
| BNMS P5V-1 | 003181402       | BNMS P24V-1 | 003181503 |

#### Characteristics

##### INPUT

|                              | 5 V DC            | 24 V DC             |
|------------------------------|-------------------|---------------------|
| Voltage                      | 4.5 V to 5.5 V DC | 20.4 V to 28.8 V DC |
| Max. current                 | 12.5 mA           | 6.7 mA              |
| Typical triggering threshold | 3.5 V DC          | 10 V DC             |
| Switching time C/O           | 20 μs / 250 μs    | 50 μs / 350 μs      |
| Leakage current              | 1 mA              | 1 mA                |

##### OUTPUT

|                                     | 5 V DC               | 24 V DC           |
|-------------------------------------|----------------------|-------------------|
| Max. voltage / Max. current         | 30 V DC / See graphs | 30 V / See graphs |
| Residual voltage max. I and rated U |                      |                   |
| standard U                          | 1 V DC               | 1 V DC            |
| max.                                | 1.3 V DC             | 1.3 V DC          |
| Frequency on inductive load         | See Note 2           | See Note 2        |
| Input / Output isolation            | 2.5 kV               | 2.5 kV            |

##### TEMPERATURE

|           | 5 V DC           | 24 V DC          |
|-----------|------------------|------------------|
| Storage   | - 30°C to + 80°C | - 30°C to + 80°C |
| Operating | - 20°C to + 60°C | - 20°C to + 60°C |

## Triac output optocoupler plug

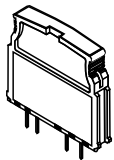

### 1 A output optocoupler 24 V DC

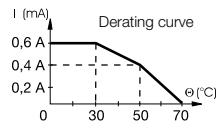
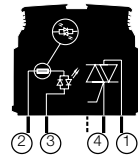

#### Part numbers

| Ref. Code   | Cat. No.  |
|-------------|-----------|
| BNMS A24V-4 | 003183913 |

#### Characteristics

##### INPUT

|                              | 24 V DC             |
|------------------------------|---------------------|
| Voltage                      | 20.4 V to 28.8 V DC |
| Max. current                 | 3.8 mA              |
| Typical triggering threshold | 10 V DC             |
| Switching time C/O           | 9.5 ms / 12 ms      |
| Leakage current              |                     |

##### OUTPUT

|                                     | 24 V DC                               |
|-------------------------------------|---------------------------------------|
| Max. voltage / Max. current         | 24 V to 253 V AC / See derating curve |
| Residual voltage max. I and rated U |                                       |
| standard U                          | 1 V AC                                |
| max.                                | 1.3 V AC                              |
| Input / Output isolation            | 2.5 kV                                |

##### TEMPERATURE

|           | 24 V DC          |
|-----------|------------------|
| Storage   | - 30°C to + 80°C |
| Operating | - 20°C to + 70°C |

## Relay plugs

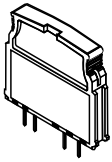

### 1 SPDT relay

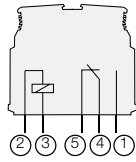

R24V-1

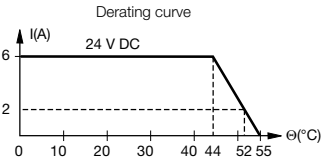

### Part numbers

| Ref. Code   | Cat. No.        |
|-------------|-----------------|
| BNMS R24V-1 | 1SNA031820R1400 |
| BNMS R24V-2 | 1SNA031847R1300 |

### Characteristics

|  | BNMS R24V-1                         | BNMS R24V-2                  |
|--|-------------------------------------|------------------------------|
| <b>COIL</b>                              |                                     |                              |
| Voltage                                  | 20.4 V to 28.8 V DC                 |                              |
| Current max.                             | 7 mA                                |                              |
| Trip voltage                             | 1.2 V                               |                              |
| <b>CONTACT</b>                           |                                     |                              |
| Type                                     | 1 SPDT                              |                              |
| Voltage mini. / max.                     | 12 V / 250 V                        | 5 V / 250 V                  |
| Switching current mini. / max.           | 10 mA / 6 A                         | 1 mA / 6 A                   |
| Switching current AC1 mini. / max.       | 0,6 VA/1500 VA (resistance)         | 0,05 VA/1500 VA (resistance) |
| DC1 mini. / max.                         | 0,6 W / 140 W                       | 0,05 W / 140 W               |
| Number of operations on load             | 10 <sup>6</sup> operations for AC15 |                              |
| Number of operations off load            | 10x10 <sup>6</sup> operations       |                              |
| Operating speed C/O                      | 6 ms / 8 ms                         |                              |
| Bounce                                   | 1,5 ms                              |                              |
| Isolation Coil / Contact                 | 4 kV                                |                              |
| Resistance to shock waves Coil / Contact | 4 kV                                |                              |
| Isolation Contact / Contact              | 1 kV                                |                              |
| <b>TEMPERATURE</b>                       |                                     |                              |
| Storage                                  | - 40°C to + 80°C                    |                              |
| Operating                                | - 20°C to + 55°C                    |                              |

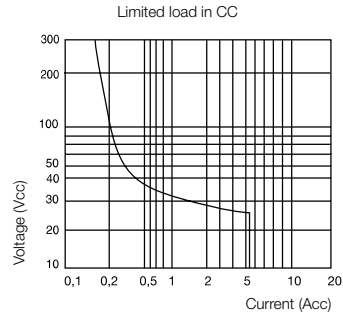

|           | DC12  | AC12 | DC13  | AC15 |
|-----------|-------|------|-------|------|
| 24 V      | 6 A   | 6 A  | 1 A   | 3 A  |
| 110/120 V | 0.3 A | 6 A  | 0.2 A | 3 A  |
| 220/230 V | 0.2 A | 6 A  | 0.1 A | 3 A  |

## Analogical plugs

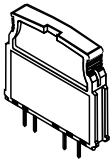

### Current / Voltage Converter

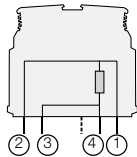

Plug with 250 Ω accuracy resistance for analogical signals.

### Current / Voltage Converter

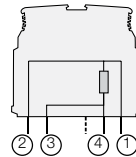

Plug with 500 Ω accuracy resistance for analogical signals.

### Part numbers

| Ref. Code       | Cat. No.        | Ref. Code       | Cat. No.        |
|-----------------|-----------------|-----------------|-----------------|
| BNMS CA I/U-250 | 1SNA031832R0400 | BNMS CA I/U-500 | 1SNA031833R0500 |

### Characteristics

|            | 250 Ω  | 500 Ω  |
|------------|--------|--------|
| Resistance | 250 Ω  | 500 Ω  |
| Power      | 0.35 W | 0.35 W |
| Accuracy   | 0.1 %  | 0.1 %  |
| Stability  | 25 ppm | 25 ppm |

## Fuse and strap plugs

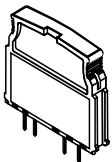

### Output fuse plug

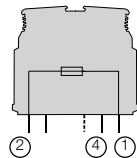

### Input fuse plug

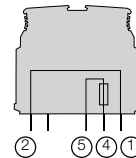

### Strap plug

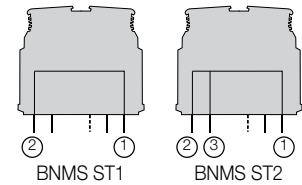

### Part numbers

| Ref. Code     | Cat. No.       | Ref. Code       | Cat. No.      | Ref. Code      | Cat. No.  |
|---------------|----------------|-----------------|---------------|----------------|-----------|
| BNMS F125mA-1 | 125 V / 125 mA | 003182101       | BNMS F125mA-3 | 125 V / 125 mA | 003182707 |
| BNMS F500mA-1 | 125 V / 500 mA | 003183812       | BNMS F125mA-4 | 250 V / 125 mA | 003182810 |
| BNMS F2A-1    | 125 V / 2 A    | 003182202       |               |                |           |
| BNMS F5A-1    | 125 V / 5 A    | 003182303       |               |                |           |
| BNMS F125mA-2 | 250 V / 125 mA | 1SNA031824R0400 |               |                |           |
| BNMS F2A-2    | 250 V / 2 A    | 003182505       |               |                |           |
| BNMS F5A-2    | 250 V / 5 A    | 1SNA031826R0600 |               |                |           |
|               |                |                 |               | BNMS ST1       | 003182911 |
|               |                |                 |               | BNMS ST2       | 003183016 |



## End stops

The end stops are mounted at the extremity of the terminal board assembly, giving additional support to the terminal blocks as markers. For various types of marking, refer to the marker section.

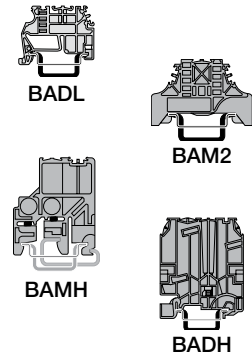

| Description                               | Ref. Code             | Catalog number | Packaging Weight kg |
|---|-----------------------|----------------|---------------------|
| End stop DIN 3                            | BADL 9 mm             | 039990302      | 50                  |
| End stop with screws DIN 3                | grey BAM2 10 mm       | 039995701      | 50                  |
|   | light grey BAM2 10 mm | 020635116      | 50                  |
|   | grey BAM2 10 mm       | 029635100      | 50                  |
| High end stop with screws DIN 1 and DIN 3 | grey BAMH 9.1 mm      | 011483600      | 50                  |
|   | beige BAMH 9.1 mm     | 019483601      | 50                  |
| High end stop with screws DIN 3           | grey BADH 12 mm       | 011690027      | 50                  |

## Mounting rails

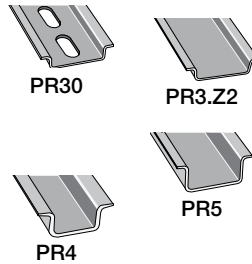

|   |            |           |   |
|---|------------|-----------|---|
| Symmetrical white passivated galvanized steel prepunched rail | PR30 2 m   | 017322005 | 1 |
| Symmetrical white passivated galvanized steel rail            | PR3.Z2 2 m | 017430017 | 1 |
| Symmetrical white passivated galvanized steel rail            | PR5 2 m    | 016870022 | 1 |
| Symmetrical white passivated galvanized steel rail            | PR4 2 m    | 016850012 | 1 |

## Test devices



|                     |     |                 |    |
|---------------------|-----|-----------------|----|
| Test plug DIA. 2 mm | FC2 | 1SNA007865R2600 | 10 |
|---------------------|-----|-----------------|----|

## Assembled jumper bar

This accessory permits electrical connection between 2 to 70 blocks with 6 mm spacing placed side by side. It can be used with screw clamp or spring clamp blocks with 6 mm or 12 mm spacing. Interconnection of blocks not placed side by side is possible if teeth of the jumper bar have been cut in front of the blocks not to be connected. These teeth can be removed using pliers. Use of separator end sections before and after the jumper bar is required to preserve IP20 protection of the assembly.

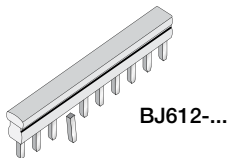

|                                      |          |           |    |
|--------------------------------------|----------|-----------|----|
| Assembled jumper bar 10 poles - 24 A | BJ612-10 | 029048801 | 10 |
|--------------------------------------|----------|-----------|----|

## Separator end section

Directly mounted on the rail beside the block, it permits to identify and make electrical insulation of product groups using jumper bars. Dimensions are the same as screw clamp blocks : width 70 mm and height on rail 67.5 mm with 2 mm spacing.

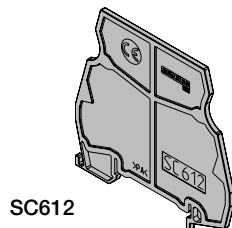

|                       |       |                 |    |
|-----------------------|-------|-----------------|----|
| Separator end section | SC612 | 1SNA290474R0200 | 10 |
|-----------------------|-------|-----------------|----|

## Distribution module

This terminal block with BJ612-... jumper bars permits 2 polarities distribution (*PCL side and process side*) thanks to two separate circuits, each of them including :

- one 4 mm<sup>2</sup> input,
- two 2,5 mm<sup>2</sup> outputs
- one double output for jumper bar BJ612-...

It permits also the connection of ground to the rail through a 4 mm<sup>2</sup> input.

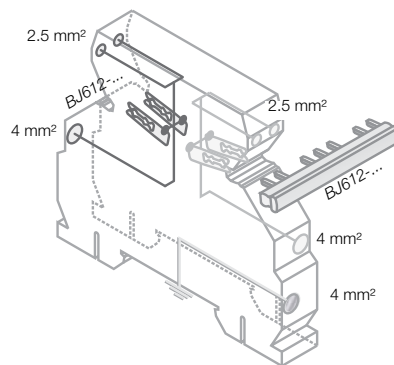
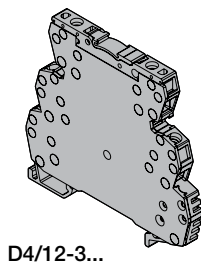

Rated voltage : 250 VAC-DC  
 Rated current : 32 A (4 mm<sup>2</sup>) - 16 A (2,5 mm<sup>2</sup>)  
 Recommended torque : 0.4 - 0.6 Nm

|   |             |                 |   |
|---|-------------|-----------------|---|
| Screw clamp distribution block sp. 12 mm  | D4/12-3-3   | 1SNA645031R2000 | 5 |
| Spring clamp distribution block sp. 12 mm | D4/12-3R-3R | 1SNA645531R2200 | 5 |

## Accessories

### PCMS

#### Comb-type jumper

This accessory permits the electrical connection of 2 to 22 blocks.

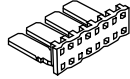

| No. of poles | Grey UL94V0     | Red UL94V0      | Blue UL94V0     | Green/Yellow UL94V0 |
|--------------|-----------------|-----------------|-----------------|---------------------|
| 2            | 1SNA205491R2300 | 1SNA205492R2400 | 1SNA205493R2500 | -                   |
| 3            | 1SNA205495R2700 | -               | -               | -                   |
| 4            | 1SNA205499R0300 | 1SNA205500R1000 | 1SNA205501R0500 | -                   |
| 5            | 1SNA205503R0700 | 1SNA205504R0000 | 1SNA205505R0100 | -                   |
| 6            | 1SNA205507R0300 | 1SNA205508R1400 | 1SNA205509R1500 | -                   |
| 7            | 1SNA205511R2600 | -               | -               | -                   |
| 8            | 1SNA205515R2200 | -               | -               | -                   |
| 9            | 1SNA205519R0600 | -               | -               | -                   |
| 10           | 1SNA205523R2200 | 1SNA205524R2300 | 1SNA205525R2400 | 1SNA205526R2500     |
| 11           | 1SNA205527R2600 | -               | -               | -                   |
| 12           | 1SNA205531R2200 | 1SNA205532R2300 | 1SNA205533R2400 | 1SNA205534R2500     |
| 13           | 1SNA205535R2600 | -               | -               | -                   |
| 14           | 1SNA205539R0200 | -               | -               | -                   |
| 15           | 1SNA205543R0600 | -               | -               | -                   |
| 16           | 1SNA205547R0200 | 1SNA205548R1300 | 1SNA205549R1400 | 1SNA205550R1100     |
| 17           | 1SNA205551R0600 | -               | -               | -                   |
| 18           | 1SNA205555R0200 | -               | -               | -                   |
| 19           | 1SNA205559R1600 | -               | -               | -                   |
| 20           | 1SNA205563R0200 | 1SNA205564R0300 | 1SNA205565R0400 | 1SNA205566R0500     |
| 21           | 1SNA205567R0600 | -               | -               | -                   |
| 22           | 1SNA205571R0200 | -               | -               | -                   |

6

## DC

### Test device on screw head

This patented device is mounted on the round screwdriver opening. It is used for trouble shooting, measuring and control for monitoring and repairing an installation, on blocks without a test socket. For this, the device receives an **FC2** test plug.



The DC's are differentiated by their colour :

blue for **MA 2.5/5** blocks

**DCB** 010502821

## BJ Jumper bar

### BJS Jumper bar not assembled

To connect terminal blocks, place the metal tube into the top center hole on each terminal block to be connected.

The metal tube contacts the terminal block's internal connector bar.

To be mounted on blocks series R910 :

Screw + washer + post **EV6D** 1SNA168400R1600



## PC

### Comb-type jumper bar

**PC** **EIP**

This accessory can be used only on the terminal blocks with at least one compression clamp connection. It permits the electrical connection of 2 to 10 blocks.

Interconnection of non-consecutive blocks is possible by removing the teeth opposite the blocks which must not be connected. The comb-type jumper bars can be cut using pliers (or a saw) : in this case, the use of an insulating tip **EIP** is recommended. The comb is placed in the compression clamp before tightening the screws, above the eventual conductor.

To be mounted on blocks series R900 and R910 :

Insulating tip for comb **EIP** 011355024  
Comb-type jumper bar **PC9** 15 A 10 poles 021016012

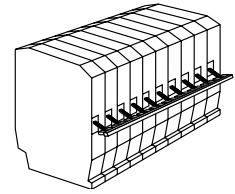

## IDC jumper

### (insulation displacement jumper)

#### Characteristics

| Wire size<br>mm <sup>2</sup> / AWG | Rigid<br>Flexible     | IEC                 | CSA    |
|------------------------------------|-----------------------|---------------------|--------|
|                                    |                       | NFC VDE             |        |
| Voltage                            | V                     | 600                 | 600    |
|                                    | Current               | A                   | 26 15  |
| Rated wire size                    | mm <sup>2</sup> / AWG | 2.5 mm <sup>2</sup> | 14 AWG |
| Working temperature                | °C                    | -55°C -> +110°C     |        |
| Protection                         |                       | IP20 / NEMA1        |        |

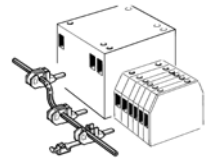
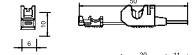

Quick-jump lets you interconnect screw clamp terminals of different sizes, levels and all manufacturers quickly and safely. Its insulation displacement technology makes it easy to use, fast, economical and does not require a special tool. Use as a jumper between relays, switches and other electronic components. ABB Quick-jump will fit any screw clamp type terminal block, from 6 mm .238" spacing and larger.

#### How to use : connecting Quick-jump to your terminal

- 1 - Insert ABB Quick-jump into your terminal screw clamp.
- 2 - Tighten the terminal screw.
- 3 - Guide jumper wire through the V-shaped opening in the Quick-jump.
- 4 - Secure the wire by closing the Quick-jump lever with any flat nose pliers.

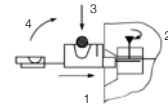

#### Adding a shunt in an installation :

- 1 - Insert ABB Quick-jump into your terminal screw clamp.
- 2 - Guide the terminal screw clamp into contact with the wire.
- 3 - Secure the wire by closing the Quick-jump lever with any flat nose pliers.
- 4 - Tighten the terminal screw.

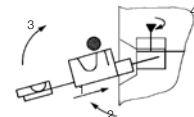

Insulation displacement jumper **AD 2.5** 011420520

## Marking for Interface Modules

### Selection table

| Markers for modules : | RC610 | RC55     | RC65 |
|-----------------------|-------|----------|------|
| R500                  | ☐     | ●        | ☐    |
| R600                  | ●     | POSSIBLE | ●    |
| R900                  | ☐     | ●        | ☐    |
| R910                  | ●     | POSSIBLE | ●    |
| R1800                 | ☐     | ●        | ☐    |

Possible mounting : **POSSIBLE**

Recommended mounting : ●

Impossible mounting : ☐

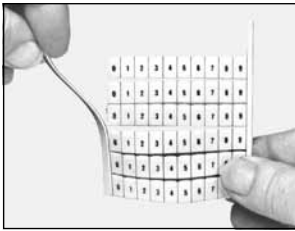

1

Remove one of the side bands of the card.

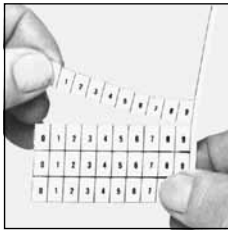

2

Separate the chosen strip from the rest of the card.

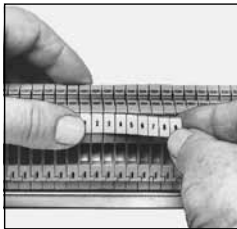

3

Press the first marker in place, hold it and slide your thumb on the rest of the strip.

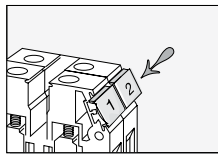

Horizontal marking

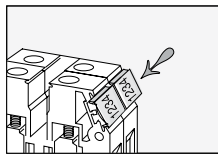

Vertical marking

## Marking for terminal blocks

### Standard RC marker cards

| Marker sizes              | RC55          | RC65          | RC610          |
|---------------------------|---------------|---------------|----------------|
| Blank cards               | 023000012     | 023200000     | 023300001      |
| <b>Horizontal marking</b> |               |               |                |
| 10 strips from 1 to 10    | 023000200 (5) | 023200226 (5) | 023300227 (25) |
| 10 strips from 11 to 20   | 023000301 (2) | 023200327 (2) | 023300320 (10) |
| 10 strips from 21 to 30   | 023000402     | 023200420     | 023300421 (6)  |
| 10 strips from 31 to 40   | 023000503     | 023200521     | 023300522 (4)  |
| 10 strips from 41 to 50   | 023000604     | 023200622     | 023300623 (3)  |
| 10 strips from 51 to 60   | 023000705     | 023200723     | 023300724 (2)  |
| 10 strips from 61 to 70   | 023000816     | 023200804     | 023300805 (2)  |
| From 1 to 100             | 023003007 (2) | 023203025 (2) | 023303026 (15) |
| From 101 to 200           | 023003124     | 023203112     | 023303113 (2)  |
| 20 times L1-L2-L3-N-PE    | 023013125     | 023213113     | 023313114 (2)  |
| <b>Vertical marking</b>   |               |               |                |
| 10 strips from 1 to 10    | 023004106     | 023204124     | 023304125 (5)  |
| 10 strips from 11 to 20   | 023004207     | 023204225     | 023304226 (3)  |
| 10 strips from 21 to 30   | 023004300     | 023204326     | 023304327 (2)  |
| 10 strips from 31 to 40   | 023004401     | 023204427     | 023304420 (2)  |
| From 1 to 100             | 023006015     | 023206003     | 023306004 (8)  |

(x) = Nb of cards in 5 mm spacing kit

(x) = Nb of cards in 6 mm spacing kit

(x) = Nb of cards in 6 mm spacing kit

# Notes

6



# Logic relays

### Concept

CL range logic relays are suitable for small and medium-sized control tasks and are able to substitute logic wiring in a quick and simple manner.

They can be used for applications in control as well as for timing functions, e. g.

- in buildings, lighting systems, air-conditioning systems, general control functions,
- in small machines and systems or
- as stand-alone control module for small applications.

## 6 Steps to the application of CL range

- CL range can be used easily, rapidly and comfortably without any time-consuming planning and programming.
- The user can discover the advantages and the benefit of these logic relays in no time at all.
- CL range provides for the control statements according to a simple circuit diagram.
- Setup, storage, simulation and documentation are performed using the compact and user-friendly CL-SOFT software (CL-LAS.PS002).

### Software characteristics (CL-SOFT)

- display on a PC monitor according to IEC, ANSI
- different languages to choose from
- easy installation on all Microsoft Windows™ operating systems

## Technical Data overview

### Logic relays

- 8 or 12 digital inputs
- 4 or 6 digital relay outputs
- optionally with 4 or 8 transistor outputs
- 128 rungs
- 3 contacts as n/o or n/c contacts in series plus 1 coil per rung
- optionally with 2 or 4 analog inputs (not 100-240 V AC version)
- power flow display for checking the circuit diagram (devices with display)
- expansions for local or remote level
- enclosure color RAL 7035
- DIN rail mounting

### Display system

- usable as compact HMI logic relay
- fully graphic, backlit display module
- 12 digital inputs
- 4 digital relay outputs
- optionally with 4 transistor outputs
- 256 rungs
- 4 contacts as n/o or n/c contacts in series plus 1 coil per rung
- optionally with 4 analog inputs (not 100-240 V AC version)
- networking-compatible via CL-NET
- front panel mounting
- expansion for local

### Logic links instead of wiring

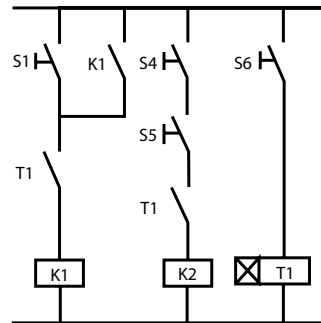

### Documentation (download from the internet)

|                       |                    |
|-----------------------|--------------------|
| Logic relay manual    | 1SVC 440 795 M0100 |
| Remote display manual | 1SVC 440 795 M2100 |
| Display system manual | 1SVC 440 795 M1100 |

### Remote display

- Remote display up to a distance of 5 m
- Illustration of text and status displays
- Remote adjustment via keypad
- Front panel mounting

### Software

- 16 timing relays 0.01-99:59 h
- 16 counting relays for up-, down counting
- 8 weekly timer, 8 annual timers
- 16 analog value comparators
- 16 freely editable display texts
- 32 markers or auxiliary relays

# Logic relays System overview

## Logic relays

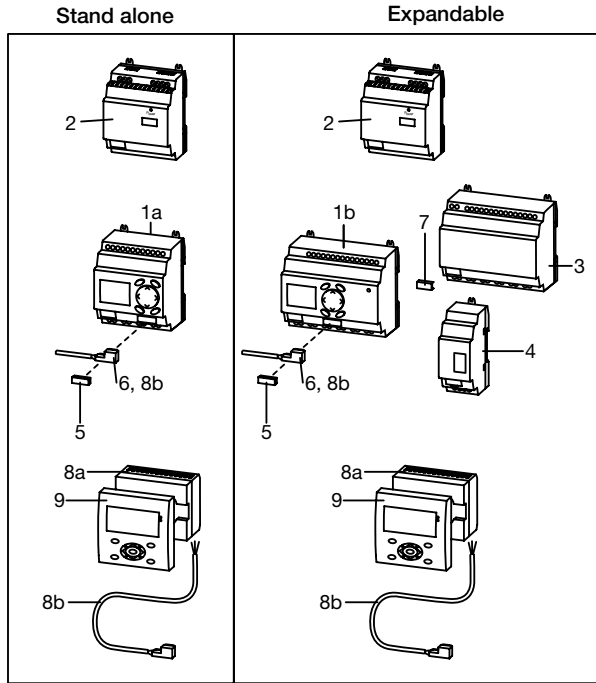

- 1a Logic relay CL-LS..
- 1b Expandable logic relay CL-LM..
- 2 Power supply CP-D...
- 3 I/O expansion CL-LER..., CL-LET.. for logic relays CL-LM..
- 4 Coupler unit CL-LEC.. for remote expansion of logic relays CL-LM..
- 5 Memory module CL-LAS.MD003 for logic relays CL-LS..., CL-LM..
- 6 Connecting cable CL-LAS.TK001, CL-LAS.TK002 to connect PC
- 7 CL-LINK plug CL-LAS.TK011 to connect expansion to logic relays CL-LM..
- 8a Remote display connection module CL-LDC.S..
- 8b Connecting cable CL-LAD.TK007 to connect a remote displays to a logic relay
- 9 Display module CL-LDD..

### Expansion of logic relays\*

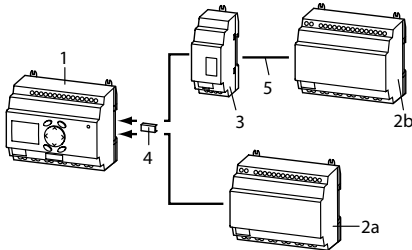

- 1 Logic relay CL-LM..
- 2 I/O expansion CL-LER..., CL-LET..  
2a local expansion  
2b remote expansion
- 3 Coupler unit CL-LEC.. for remote expansion of logic relays CL-LM..
- 4 CL-LINK plug CL-LAS.TK011 for expansion of logic relays CL-LM..
- 5 up to 30 m

\* max. 1 expansion per logic relay

## Display system → Compact HMI logic relay

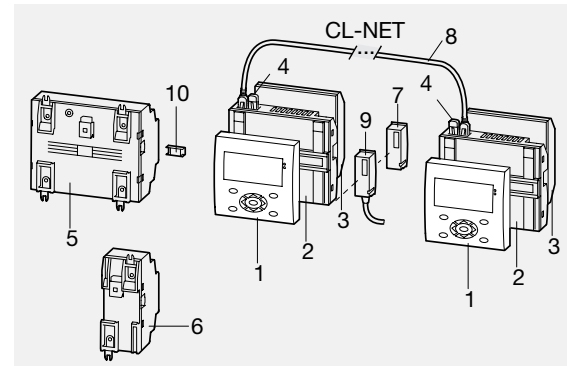

- 1 Display module CL-LDD..
- 2 Display base module CL-LDC.LN..
- 3 Display I/O module CL-LDR..., CL-LDT..
- 4 Termination resistor CL-LAD.TK009
- 5 I/O expansion CL-LER..., CL-LET..
- 6 Coupler unit CL-LEC.. for remote expansion
- 7 Memory module CL-LAD.MD004 for display base module
- 8 Connecting cable CL-LAD.TK002, CL-LAD.TK003, CL-LAD.TK004
- 9 Connecting cable CL-LAD.TK001, CL-LAD.TK011 to connect PC
- 10 CL-LINK plug CL-LAS.TK011 for expansion of logic relays CL-LM..
- e.g. door of switchgear cabinet

## Stand alone with I/O module

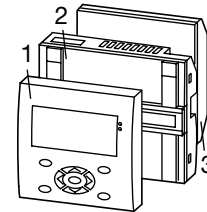

- 1 Display CL-LDD..
- 2 Remote display connection module CL-LDC.S.. incl. connecting cable
- 3 Display base module CL-LDC.L..

## Communication via CL-NET

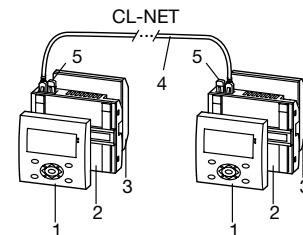

- 1 Display CL-LDD..
- 2 Display base module CL-LDC.LN.. for CL-NET
- 3 Display I/O module CL-LDR..., CL-LDT..
- 4 Connecting cable CL-LAD.TK002, CL-LAD.TK003, CL-LAD.TK004
- 5 Termination resistor CL-LAD.TK009

■ existing  
□ pending

|   |        | Logic relays |        |        |        | Expansions |        |        | Display system |                 |                 |        | Accessories     |                 |
|---|--------|--------------|--------|--------|--------|------------|--------|--------|----------------|-----------------|-----------------|--------|-----------------|-----------------|
|   |        | CL-LSR       | CL-LST | CL-LMR | CL-LMT | CL-LER     | CL-LET | CL-LEC | CL-LDD         | CL-LDC          | CL-LDR          | CL-LDT | CL-LAS          | CL-LAD          |
| <b>Approvals</b>                              |        |              |        |        |        |            |        |        |                |                 |                 |        |                 |                 |
| UL  |        | ■            | ■      | ■      | ■      | ■          | ■      | ■      | ■              | ■               | ■               | ■      | ■ <sup>1)</sup> | ■ <sup>2)</sup> |
| CAN/CSA C22.2 No.14                           |        | ■            | ■      | ■      | ■      | ■          | ■      | ■      | ■              | ■               | ■               | ■      | ■ <sup>1)</sup> | ■ <sup>2)</sup> |
| CAN/CSA C22.2 No.213<br>(hazardous locations) |        | ■            | ■      | ■      | ■      | ■          | ■      | ■      | ■              | ■               | ■               | ■      | ■ <sup>1)</sup> | ■ <sup>2)</sup> |
| GL  |        | ■            | ■      | ■      | ■      |            |        |        | ■              | ■ <sup>3)</sup> | ■ <sup>4)</sup> | ■      |                 |                 |
| GOST  |        | ■            | ■      | ■      | ■      | ■          | ■      | ■      | ■              | ■               | ■               | ■      | ■               | ■               |
| Lloyds Register                               |        | ■            | ■      | ■      | ■      |            |        |        | ■              | ■ <sup>3)</sup> | ■ <sup>4)</sup> | ■      |                 |                 |
| <b>Marks</b>                                  |        |              |        |        |        |            |        |        |                |                 |                 |        |                 |                 |
| CE  | CE     | ■            | ■      | ■      | ■      | ■          | ■      | ■      | ■              | ■               | ■               | ■      | ■               | ■               |
| C-Tick  | C-Tick | □            | □      | □      | □      | □          | □      | □      | □              | □               | □               | □      | □               | □               |

<sup>1)</sup> not for: CL-LAS-PS002, CL-LAS.TD001, CL-LAS.FD001, CL-LAS.TK002, CL-LAS.TK011

<sup>2)</sup> not for: CL-LAD.TK006, CL-LAD.TK011, CL-LAD.FD002

<sup>3)</sup> not for: CL-LDC.SDC2, CL-LDC.SAC2, CL-LDC.LAC2, CL-LDC.LNAC2

<sup>4)</sup> not for: CL-LDR.16AC2



# Logic relays

## Ordering details

### Stand alone logic relays



CL-LSR



CL-LST

#### Logic relays stand alone

| Rated operational voltage | Display + Keypad | Timer | Input / Output             | Reference code                  | Catalog number  | Weight (1 pce) kg (lb) |                 |
|---------------------------|------------------|-------|----------------------------|---------------------------------|-----------------|------------------------|-----------------|
| 24 V AC                   | ■                | ■     | 8 inputs / 4 relay outputs | CL-LSR.C12AC1                   | 1SVR440712R0300 | 0.20 (0.44)            |                 |
|                           |                  | ■     |                            | CL-LSR.CX12AC1                  | 1SVR440712R0200 |                        |                 |
| 100-240 V AC              | ■                |       |                            | CL-LSR.12AC2                    | 1SVR440713R0100 |                        |                 |
|                           | ■                | ■     |                            | CL-LSR.C12AC2                   | 1SVR440713R0300 |                        |                 |
|                           |                  | ■     |                            | CL-LSR.CX12AC2                  | 1SVR440713R0200 |                        |                 |
|                           |                  | ■     |                            | CL-LSR.C12DC1                   | 1SVR440710R0300 |                        |                 |
| 12 V DC                   | ■                | ■     |                            | CL-LSR.CX12DC1                  | 1SVR440710R0200 |                        |                 |
| 24 V DC                   | ■                |       |                            | CL-LSR.12DC2                    | 1SVR440711R0100 |                        |                 |
|                           | ■                | ■     |                            | CL-LSR.C12DC2                   | 1SVR440711R0300 |                        |                 |
|                           |                  | ■     |                            | CL-LSR.CX12DC2                  | 1SVR440711R0200 |                        |                 |
| 24 V DC                   | ■                | ■     |                            | 8 inputs / 4 transistor outputs | CL-LST.C12DC2   |                        | 1SVR440711R1300 |
|                           |                  | ■     |                            |                                 | CL-LST.CX12DC2  |                        | 1SVR440711R1200 |

6

#### Display modules



CL-LDD.K

| Rated operational voltage | Description  | Reference code | Catalog number  | Weight (1 pce) kg (lb) |
|---------------------------|--|----------------|-----------------|------------------------|
| -                         | Graphic display 132 x 64 pixel                             | CL-LDD.XK      | 1SVR440839R4500 | 0.14 (0.30)            |
| -                         | Graphic display 132 x 64 pixel, with keypad                | CL-LDD.K       | 1SVR440839R4400 | 0.13 (0.29)            |
| 24 V DC                   | Module to displace the display from the logic relay, incl. | CL-LDC.SDC2    | 1SVR440841R0000 | 0.16 (0.36)            |
| 100-240 V DC              | connecting cable CL-LAD.TK007, 5m, length adaptable        | CL-LDC.SAC2    | 1SVR440843R0000 | 0.16 (0.36)            |



CL-LDC.S..

## Logic relays

### Ordering details

### Expandable logic relays



CL-LMR



CL-LER



CL-LEC

#### Logic relays expandable

| Rated operational voltage | Display + Keypad | Timer | Input / Output              | Reference code  | Catalog number  | Weight (1 pce) kg (lb) |
|---------------------------|------------------|-------|-----------------------------|-----------------|-----------------|------------------------|
| 24 V AC                   | ■                | ■     | 12 inputs / 6 relay outputs | CL-LMR.C18AC1   | 1SVR440722R0300 | 0.36 (0.79)            |
| 100-240 V AC              | ■                | ■     |                             | CL-LMR.CX18AC1  | 1SVR440722R0200 |                        |
|                           |                  |       |                             | CL-LMR.C18AC2   | 1SVR440723R0300 |                        |
| 12 V DC                   | ■                | ■     |                             | CL-LMR.CX18AC2  | 1SVR440723R0200 |                        |
|                           |                  |       |                             | CL-LMR.C18DC1   | 1SVR440720R0300 |                        |
| 24 V DC                   | ■                | ■     |                             | CL-LMR.CX18DC1  | 1SVR440720R0200 |                        |
|                           |                  |       | CL-LMR.C18DC2               | 1SVR440721R0300 |                 |                        |
| 24 V DC                   | ■                | ■     | CL-LMR.CX18DC2              | 1SVR440721R0200 |                 |                        |
|                           |                  |       | CL-LMT.C20DC2               | 1SVR440721R1300 | 0.36 (0.79)     |                        |
| 24 V DC                   | ■                | ■     | CL-LMT.CX20DC2              | 1SVR440721R1200 |                 |                        |

#### Expansions

| Rated operational voltage | Description   | Reference code | Catalog number  | Weight (1 pce) kg (lb) |
|---------------------------|---|----------------|-----------------|------------------------|
| -                         | 2 relay outputs   | CL-LER.2O      | 1SVR440709R5000 | 0.07 (0.15)            |
| 100-240 V AC              | 12 inputs, 6 relay outputs                                      | CL-LER.18AC2   | 1SVR440723R0000 | 0.26 (0.57)            |
|                           |   | CL-LER.18DC2   | 1SVR440721R0000 | 0.22 (0.49)            |
| 24 V DC                   | 12 inputs, 8 transistor outputs                                 | CL-LET.20DC2   | 1SVR440721R1000 | 0.21 (0.46)            |
| -                         | Coupler unit for remote expansion with a distance of up to 30 m | CL-LEC.CI000   | 1SVR440709R0000 | 0.07 (0.15)            |

## Logic relays

### Ordering details

#### CL-LA...



CL-LAS.PS002



CL-LAS.TK001



CL-LAS.MD003

| Description  | Reference code             | Catalog number  | Weight (1 pce)<br>kg (lb) |
|--|----------------------------|-----------------|---------------------------|
| Software for programming and control of CL range devices. Installation CD-ROM for Microsoft Windows™.                      | CL-LAS.PS002               | 1SVR440799R8000 | 0.10 (0.21)               |
| Memory module for logic relays<br>Memory size: 32 kB   | CL-LAS.MD003               | 1SVR440799R7000 | 0.02 (0.04)               |
| Cable with serial interface to connect PC and logic relay.<br>Length: 2 m  | CL-LAS.TK001               | 1SVR440799R6000 | 0.10 (0.22)               |
| Cable with USB interface to connect PC and logic relay   | CL-LAS.TK002               | 1SVR440799R6100 | 0.06 (0.13)               |
| Cable for point-to-point connection of remote-display connection module and logic relay, length adaptable                  | CL-LAD.TK007               | 1SVR440899R6600 | 0.20 (0.44)               |
| Fixing brackets for screw mounting of logic relay, expansion, display base module  | CL-LAS.FD001               | 1SVR440799R5000 | 0.01 (0.01)               |
| Spare plug (CL-LINK) for connection of logic relay to expansion  | CL-LAS.TK011               | 1SVR440799R5100 | 0.10 (0.22)               |
| Primary switch mode power supplies,<br>Rated input voltage: 100-240 V AC<br>Rated output voltage/current: 24 V DC / 0.42 A | CP-D 24/0.42 <sup>1)</sup> | 1SVR427041R0000 | 0.06 (0.13)               |
| Primary switch mode power supplies,<br>Rated input voltage: 100-240 V AC<br>Rated output voltage/current: 24 V DC / 1.3 A  | CP-D 24/1.3 <sup>2)</sup>  | 1SVR427043R0100 | 0.19 (0.41)               |

<sup>1)</sup> replaces CL-LAS.SD001, technical data see chapter "Primary switch mode power supplies"

<sup>2)</sup> replaces CL-LAS.SD002, technical data see chapter "Primary switch mode power supplies"

## Logic relays

### Ordering details

### Display systems

#### Display systems

| Rated operational voltage | Description  | Reference code | Catalog number  | Weight (1 pce) kg (lb) |
|---------------------------|--|----------------|-----------------|------------------------|
| -                         | Display module<br>Graphic display 132 x 64 pixel                       | CL-LDD.XK      | 1SVR440839R4500 | 0.14 (0.30)            |
| -                         | Display module<br>Graphic display 132 x 64 pixel, with keypad          | CL-LDD.K       | 1SVR440839R4400 | 0.13 (0.29)            |
| 24 V DC                   | Display base module  | CL-LDC.LDC2    | 1SVR440821R0000 | 0.16 (0.36)            |
| 100-240 V AC              | CPU / power supply   | CL-LDC.LAC2    | 1SVR440823R0000 |                        |
| 24 V DC                   | Display base module  | CL-LDC.LNDC2   | 1SVR440821R1000 | 0.17 (0.38)            |
| 100-240 V AC              | CPU / power supply, networking-compatible (CL-NET)                     | CL-LDC.LNAC2   | 1SVR440823R1000 |                        |
| 100-240 V AC              | Display I/O module   | CL-LDR.16AC2   | 1SVR440853R0000 | 0.17 (0.38)            |
| 24 V DC                   | 12 inputs, 4 relay outputs   | CL-LDR.16DC2   | 1SVR440851R0000 |                        |
| 24 V DC                   | Display I/O module<br>12 inputs, 4 relay outputs,<br>1 analog output   | CL-LDR.17DC2   | 1SVR440851R2000 | 0.17 (0.38)            |
| 24 V DC                   | Display I/O module<br>12 inputs, 4 transistor outputs                  | CL-LDT.16DC2   | 1SVR440851R1000 | 0.14 (0.30)            |
| 24 V DC                   | Display I/O module<br>12 inputs, 4 transistor outputs, 1 analog output | CL-LDT.17DC2   | 1SVR440851R3000 | 0.14 (0.30)            |



CL-LDD.K



CL-LDC.LN..

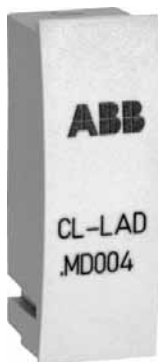

CL-LAD.MD004



CL-LAD.TK001



CL-LAD.TK002

#### CL-LAD...

| Description   | Reference code | Catalog number  | Weight (1 pce) kg (lb) |
|---|----------------|-----------------|------------------------|
| Memory module for display base modules<br>Memory size: 256 kB   | CL-LAD.MD004   | 1SVR440899R7000 | 0.02 (0.03)            |
| Cable with serial interface to connect PC and display base module   | CL-LAD.TK001   | 1SVR440899R6000 | 0.11 (0.23)            |
| Cable with USB interface to connect PC and display base module  | CL-LAD.TK011   | 1SVR440899R6700 |                        |
| Network cable (CL-NET) to connect 2 display base modules Length: 0.3 m  | CL-LAD.TK002   | 1SVR440899R6100 | 0.05 (0.12)            |
| Network cable (CL-NET) to connect 2 display base modules Length: 0.8 m  | CL-LAD.TK003   | 1SVR440899R6200 | 0.07 (0.14)            |
| Network cable (CL-NET) to connect 2 display base modules Length: 1.5 m  | CL-LAD.TK004   | 1SVR440899R6300 | 0.08 (0.18)            |
| Cable for point-to-point connection of remote display connection modules and display base module, length adaptable, Length: 5 m | CL-LAD.TK005   | 1SVR440899R6400 | 0.20 (0.44)            |
| Cable for point-to-point connection of 2 display base modules, length adaptable. Length: 5 m                                    | CL-LAD.TK006   | 1SVR440899R6500 | 0.12 (0.26)            |
| Termination resistor, content: 2 pieces   | CL-LAD.TK009   | 1SVR440899R6900 | 0.01 (0.02)            |
| Protective cover, transparent, for harsh environmental conditions and application in the food industry                          | CL-LAD.FD001   | 1SVR440899R1000 | 0.03 (0.07)            |
| Protective cover, transparent and sealable  | CL-LAD.FD011   | 1SVR440899R2000 | 0.03 (0.07)            |
| Assembly tool for mounting of display modules   | CL-LAD.FD002   | 1SVR440899R3000 |                        |

# Logic relays

## Technical data

Data at  $T_a = 25\text{ °C}$  and rated values, if nothing else indicated.

| Type                                     | CL-LSR.C...12DC1 | CL-LSR....12DC2<br>CL-LST.C...12DC2 | CL-LSR.C...12AC1 | CL-LSR...12AC2 |
|--|------------------|-------------------------------------|------------------|----------------|
| <b>Input circuit - supply circuit</b>    |                  |                                     |                  |                |
| Rated operational voltage $U_n$          | 12 V DC          | 24 V DC                             | 24 V AC          | 100-240 V AC   |
| Rated operational voltage tolerance      | -15...+30 %      | -15...+20 %                         | -15...+10 %      | -              |
| Operational voltage range                | 10.2-15.6 V DC   | 20.4-28.8 V DC                      | 20.4-26.4 V AC   | 85-264 V AC    |
| Rated frequency                          | -                | 0 Hz                                | -                | 50/60 Hz       |
| Rated frequency tolerance                | -                | -                                   | -                | ±5 %           |
| Residual ripple                          | -                | ≤ 5 %                               | -                | -              |
| Input current                            |                  |                                     |                  |                |
| at 12 V DC                               | typ. 140 mA      | -                                   | -                | -              |
| at 24 V DC                               | -                | typ. 80 mA                          | -                | -              |
| at 24 V AC                               | -                | -                                   | typ. 200 mA      | -              |
| at 115/120 V AC (60 Hz)                  | -                | -                                   | -                | typ. 40 mA     |
| at 230/240 V AC (50 Hz)                  | -                | -                                   | -                | typ. 20 mA     |
| Power failure buffering (IEC/EN 61131-2) | -                | 10 ms                               | -                | 20 ms          |
| Power dissipation                        |                  |                                     |                  |                |
| at 12 V DC                               | typ. 2 W         | -                                   | -                | -              |
| at 24 V DC                               | -                | typ. 2 W                            | -                | -              |
| at 24 V AC                               | -                | -                                   | typ. 5 VA        | -              |
| at 115/120 V AC                          | -                | -                                   | -                | typ. 5 VA      |
| at 230/240 V AC                          | -                | -                                   | -                | typ. 5 VA      |

6

| Type                                     | CL-LMR.C...18DC1 | CL-LMR.C...18DC2<br>CL-LMT.C...20DC2 | CL-LMR.C...18AC1 | CL-LMR.C...18AC2 |
|--|------------------|--------------------------------------|------------------|------------------|
| <b>Input circuit - supply circuit</b>    |                  |                                      |                  |                  |
| Rated operational voltage $U_n$          | 12 V DC          | 24 V DC                              | 24 V AC          | 100-240 V AC     |
| Rated operational voltage tolerance      | -15...+30 %      | -15...+20 %                          | -15...+10 %      | -                |
| Operational voltage range                | 10.2-15.6 V DC   | 20.4-28.8 V DC                       | 20.4-26.4 V AC   | 85-264 V AC      |
| Rated frequency                          | -                | 0 Hz                                 | -                | 50/60 Hz         |
| Rated frequency tolerance                | -                | -                                    | -                | ±5 %             |
| Residual ripple                          | -                | ≤ 5 %                                | -                | -                |
| Input current                            |                  |                                      |                  |                  |
| at 12 V DC                               | typ. 200 mA      | -                                    | -                | -                |
| at 24 V DC                               | -                | typ. 140 mA                          | -                | -                |
| at 24 V AC                               | -                | -                                    | typ. 300 mA      | -                |
| at 115/120 V AC (60 Hz)                  | -                | -                                    | -                | typ. 70 mA       |
| at 230/240 V AC (50 Hz)                  | -                | -                                    | -                | typ. 35 mA       |
| Power failure buffering (IEC/EN 61131-2) | -                | 10 ms                                | -                | 20 ms            |
| Power dissipation                        |                  |                                      |                  |                  |
| at 12 V DC                               | typ. 3.5 W       | -                                    | -                | -                |
| at 24 V DC                               | -                | typ. 3.5 W                           | -                | -                |
| at 24 V AC                               | -                | -                                    | typ. 7 VA        | -                |
| at 115/120 V AC                          | -                | -                                    | -                | typ. 10 VA       |
| at 230/240 V AC                          | -                | -                                    | -                | typ. 10 VA       |

| Type                                     | CL-LER.18DC2<br>CL-LET.20DC2 | CL-LER.18AC2 |   |   |
|--|------------------------------|--------------|---|---|
| <b>Input circuit - supply circuit</b>    |                              |              |   |   |
| Rated operational voltage $U_n$          | 24 V DC                      | 100-240 V AC | - | - |
| Rated operational voltage tolerance      | -15...+20 %                  | -15...+10 %  | - | - |
| Operational voltage range                | 20.4-28.8 V DC               | 85-264 V AC  | - | - |
| Rated frequency                          | 0 Hz                         | 50/60 Hz     | - | - |
| Rated frequency tolerance                | -                            | ±5 %         | - | - |
| Residual ripple                          | ≤ 5 %                        | -            | - | - |
| Input current                            |                              |              |   |   |
| at 24 V DC                               | typ. 140 mA                  | -            | - | - |
| at 115/120 V AC (60 Hz)                  | -                            | typ. 70 mA   | - | - |
| at 230/240 V AC (50 Hz)                  | -                            | typ. 35 mA   | - | - |
| Power failure buffering (IEC/EN 61131-2) | 10 ms                        | 20 ms        | - | - |
| Power dissipation                        |                              |              |   |   |
| at 24 V DC                               | typ. 3.4 W                   | -            | - | - |
| at 115/120 V AC                          | -                            | typ. 10 VA   | - | - |
| at 230/240 V AC                          | -                            | typ. 10 VA   | - | - |

Data at  $T_a = 25\text{ °C}$  and rated values, if nothing else indicated.

| Type                                  |   | CL-LSR.C...12DC1   | CL-LSR...12DC2<br>CL-LST.C...12DC2                         | CL-LSR.C...12AC1  | CL-LSR.C...12AC2   |
|---------------------------------------|---|--|--|---|--|
| <b>Input circuit - Digital inputs</b> |   |  |  |   |  |
| Number                                |   | 12 V DC  | 24 V DC  | 24 V AC   | 115 / 230 V AC   |
| Inputs can be used as analog inputs   |   |  | 2 (I7, I8)   |   | -  |
| Indication of operational states      |   |  | LCD-Display (if existing)                                  |   |  |
| Electrical isolation                  | from voltage supply                               |  |  | no  |  |
|                                       | between digital inputs                            |  |  | no  |  |
|                                       | from the outputs                                  |  |  | yes   |  |
| Rated operational voltage $U_o$       |   | 12 V DC  | 24 V DC  | 24 V AC   |  |
|                                       | $U_o$ on „0“ signal                               | 4 V DC (I1-I8)   | < 5 V DC (I1-I8)   | 0-6 V AC (sinusoidal)   | 0-40 V AC (sinusoidal)   |
|                                       | $U_o$ on „1“ signal                               | 8 V DC (I1-I8)   | > 15 V DC (I1-I6),<br>> 8 V DC (I7, I8)                    | > 9.5 V DC, 14-26,4 V AC<br>(sinusoidal) (I1-I6),<br>> 7 V AC (sinusoidal) (I7,I8)                      | 79-264 V AC<br>(sinusoidal)  |
| Rated frequency                       |   |  |  | 50-60 Hz  |  |
| Input current on „1“ signal           |   |  |  |   | 6x0.25 mA  |
|                                       |   | 3.3 mA (at 12 V DC, I1-I6),<br>1.1 mA (at 12 V DC, I7, I8) | 3.3 mA (at 24 V DC, I6-I7),<br>2.2 mA (at 24 V DC, I7, I8) | 4 mA (at 24 V AC, 50 Hz,<br>I1-I6),<br>2 mA (at 24 V AC, 50 Hz,<br>I7,I8),<br>2 mA (at 24 V DC, I7, I8) | (at 115 V AC, 60 Hz, I1-I6),<br>6x0.5 mA<br>(at 230 V AC, 50 Hz, I1-I6)<br>2x4 mA<br>(at 115 V AC, 60 Hz, I7, I8),<br>2x6 mA<br>(at 230 V AC, 50 Hz, I7, I8) |
| Time delay from „0“ to „1“            | debounce ON                                       |  | 20 ms  | 80 ms (at 50 Hz), 66 <sup>2</sup> / <sub>3</sub> ms (at 60 Hz)  |  |
|                                       | debounce OFF                                      | typ. 0.3 ms (I1-I6),<br>typ. 0.35 ms (I7, I8)              | typ. 0.25 ms (I1-I8)                                       | 20 ms (at 50 Hz), 16 <sup>2</sup> / <sub>3</sub> ms (at 60 Hz)  |  |
| Time delay from „1“ to „0“            | debounce ON                                       |  | 20 ms  | 80 ms (at 50 Hz,<br>66 <sup>2</sup> / <sub>3</sub> ms (at 60 Hz)  | 80 ms (at 50 Hz, I1-I6),<br>66 <sup>2</sup> / <sub>3</sub> ms (at 60 Hz, I1-I6)<br>160 ms (at 50 Hz, I7, I8),<br>150 ms (at 60 Hz, I7, I8)                   |
|                                       | debounce OFF                                      | typ. 0.3 ms (I1-I6),<br>typ. 0.15 ms (I7, I8)              | -  | 20 ms (at 50 Hz),<br>16 <sup>2</sup> / <sub>3</sub> ms (at 60 Hz)                                       | 20 ms (at 50 Hz, I1-I6),<br>16 <sup>2</sup> / <sub>3</sub> ms (at 60 Hz, I1-I6)<br>100 ms (at 50 Hz, I7, I8),<br>100 ms (at 60 Hz, I7, I8)                   |
| Cable length (unshielded)             |   | 100 m  |  | -   | -  |
| Maximum cable length per input        |   | -  | -  | 40 m  | 40 m (I1-I6), 100 m (I7, I8)   |
| Frequency counter                     | Number  | 2 (I3, I4)   |  | -   | -  |
|                                       | counting frequency                                | < 1 kHz  |  | -   | -  |
|                                       | pulse shape                                       | square-wave  |  | -   | -  |
|                                       | pulse / pause ratio                               | 1:1  |  | -   | -  |
| Rapid counter inputs                  | Number  | 2 (I1, I2)   |  | -   | -  |
|                                       | counting frequency                                | < 1 kHz  |  | -   | -  |
|                                       | pulse shape                                       | square-wave  |  | -   | -  |
|                                       | pulse / pause ratio                               | 1:1  |  | -   | -  |
| Cable length (shielded)               |   | < 20 m   |  | -   | -  |
| <b>Input circuit - Analog inputs</b>  |   |  |  |   |  |
| Number                                |   |  | 2 (I7, I8)   |   | -  |
| Electrical isolation                  | from voltage supply                               |  | no   |   | -  |
|                                       | from the digital inputs                           |  | no   |   | -  |
|                                       | from the outputs                                  |  | yes  |   | -  |
|                                       | from PC interface, memory module, CL-NET, CL-LINK |  | no   |   | -  |
| Input type                            |   |  | DC voltage   |   | -  |
| Signal range                          |   |  | 0-10 V DC  |   | -  |
| Resolution                            | analog  |  | 0.01 V   |   | -  |
|                                       | digital   |  | 0.01 V; 10 Bit (value 1-1023)                              |   | -  |
| Input impedance                       |   |  | 11.2 kΩ  |   | -  |
| Accuracy of the actual value          | two CL devices                                    |  | ±3 %   |   | -  |
|                                       | within one device                                 |  | ±2 %, ±0.12 V  |   | -  |
| Conversion time analog/digital        | Input delay ON                                    |  | 20 ms  |   | -  |
|                                       | Input delay OFF                                   |  | each cycle   |   | -  |
| Input current                         |   |  | < 1 mA   |   | -  |
| Cable length (shielded)               |   |  | < 30 m   |   | -  |

# Logic relays

## Technical data

Data at  $T_a = 25\text{ °C}$  and rated values, if nothing else indicated.

| Type                                  |   | CL-LMR.C...18DC1  | CL-LMR.C...18DC2<br>CL-LMT.C...20DC2                                       | CL-LMR.C...18AC1  | CL-LMR.C...18AC2  |
|---------------------------------------|---|---|--|---|---|
| <b>Input circuit - Digital inputs</b> |   |   |  |   |   |
| Number                                |   | 12 V DC   | 24 V DC  | 24 V AC   | 115 / 230 V AC  |
| Inputs can be used as analog inputs   |   |   | 4 (I7, I8, I11, I12)   |   | -   |
| Indication of operational states      |   |   | LCD-Display (if existing)  |   |   |
| Electrical isolation                  | from voltage supply                               |   |  | no  |   |
|                                       | between digital inputs                            |   |  | no  |   |
|                                       | from the outputs                                  |   |  | yes   |   |
|                                       | from PC interface, memory module, CL-NET, CL-LINK |   | no   |   | yes   |
| Rated operational voltage $U_o$       |   | 12 V DC   | 24 V DC  | 24 V AC   |   |
|                                       | $U_o$ on „0“ signal                               | 4 V DC (I1-I12)   | < 5 V DC (I1-I12, R1-R12)  | 0-6 V AC (sinusoidal)   | 0-40 V AC (sinusoidal)  |
|                                       | $U_o$ on „1“ signal                               | 8 V DC (I1-I12)   | > 15 V DC (I1-I6, I9, I10)<br>> 8 V DC (I7, I8, I11, I12)                  | > 9.5 V DC, 14-26.4 V AC (sinusoidal) (I1-I6, I9, I10)<br>> 7 V AC (sinusoidal) (I7, I8; I11, I12)                        | 79-264 V AC (sinusoidal)  |
| Rated frequency                       |   |   |  | 50-60 Hz  |   |
| Input current on „1“ signal           |   |   |  |   | 6x0.25 mA (at 115 V AC, 60 Hz, I1-I6), 6x0.5 mA (at 230 V AC, 50 Hz, I1-I6)   |
|                                       |   | 3.3 mA (at 12 V DC, I1-I6, I9-I12), 1.1 mA (at 12 V DC, I7, I8) | 3.3 mA (at 24 V DC, I1-I6, I9, I10), 2.2 mA (at 24 V DC, I7, I8, I11, I12) | 4 mA (at 24 V AC, 50 Hz, I1-I6, I9, I10), 2 mA (at 24 V AC, 50 Hz, I7, I8, I11, I12), 2 mA (at 24 V DC, I7, I8, I11, I12) | 2x4 mA (at 115 V AC, 60 Hz, I7, I8), 2x6 mA (at 230 V AC, 50 Hz, I7, I8), 4x0.25 mA (at 115 V AC, 60 Hz, I9-I12), 4x0.5 mA (at 230 V AC, 50 Hz, I9-I12) |
| Time delay from „0“ to „1“            | debounce ON                                       | 20 ms   |  | 80 ms (at 50 Hz), 66 <sup>2</sup> / <sub>3</sub> ms (at 60 Hz)  |   |
|                                       | debounce OFF                                      | typ. 0.3 ms (I1-I6, I9, I10), typ. 0.35 ms (I7, I8, I11, I12)   | typ. 0.25 ms   | 20 ms (at 50 Hz), 16 <sup>2</sup> / <sub>3</sub> ms (at 60 Hz)  |   |
| Time delay from „1“ to „0“            | debounce ON                                       | 20 ms   |  | 80 ms (at 50 Hz), 66 <sup>2</sup> / <sub>3</sub> ms (at 60 Hz)  |   |
|                                       | debounce OFF                                      | typ. 0.4 ms (I1-I6, I9, I10), typ. 0.35 ms (I7, I8, I11, I12)   | -  | 20 ms (at 50 Hz), 16 <sup>2</sup> / <sub>3</sub> ms (at 60 Hz)  |   |
| Cable length (unshielded)             |   | 100 m   |  |   |   |
| Maximum cable length per input        |   |   |  | max. 40 m, typ. 40 m (I9, I10)  | typ. 40 m (I1-I6, I9-I12), typ. 100 m (I7, I8)  |
| Frequency counter                     | number  | 2 (I3, I4)  |  | -   | -   |
|                                       | counting frequency                                | < 1 kHz   |  | -   | -   |
|                                       | pulse shape                                       | square-wave   |  | -   | -   |
|                                       | pulse / pause ratio                               | 1:1   |  | -   | -   |
| Rapid counter inputs                  | number  | 2 (I1, I2)  |  | -   | -   |
|                                       | counting frequency                                | < 1 kHz   |  | -   | -   |
|                                       | pulse shape                                       | square-wave   |  | -   | -   |
|                                       | pulse / pause ratio                               | 1:1   |  | -   | -   |
| Cable length (shielded)               |   | < 20 m  |  |   |   |
| <b>Input circuit - Analog inputs</b>  |   |   |  |   |   |
| Number                                |   | 4 (I7, I8, I11, I12)  |  |   | -   |
| Electrical isolation                  | from voltage supply                               |   | no   |   | -   |
|                                       | from the digital inputs                           |   | no   |   | -   |
|                                       | from the outputs                                  |   | yes  |   | -   |
|                                       | from PC interface, memory module, CL-NET, CL-LINK |   | no   |   | -   |
| Input type                            |   | DC voltage  |  |   | -   |
| Signal range                          |   | 0-10 V DC   |  |   | -   |
| Resolution                            | analog  | 0.01 V  |  |   | -   |
|                                       | digital   | 0.01 V; 10 Bit (value 1-1023)                                   |  |   | -   |
| Input impedance                       |   | 11.2 k $\Omega$   |  |   | -   |
| Accuracy of the actual value          | two CL devices                                    | $\pm 3\%$   |  |   | -   |
|                                       | within one device                                 | $\pm 2\%$ , $\pm 0.12\text{ V}$                                 |  |   | -   |
| Conversion time analog/digital        | Input delay ON                                    | 20 ms   |  |   | -   |
|                                       | Input delay OFF                                   | each cycle  |  |   | -   |
| Input current                         |   | < 1 mA  |  |   | -   |
| Cable length (shielded)               |   | < 30 m  |  |   | -   |

Data at  $T_a = 25\text{ °C}$  and rated values, if nothing else indicated.

| Type                                  |   | CL-LER.18DC2<br>CL-LET.20DC2 | CL-LER.18AC2  |
|---------------------------------------|---|------------------------------|---|
| <b>Input circuit - Digital inputs</b> |   | <b>24 V DC</b>               | <b>115 / 230 V AC</b>   |
| Number                                |   |                              | 12  |
| Inputs can be used as analog inputs   |   |                              | -   |
| Indication of operational states      |   |                              | -   |
| Electrical isolation                  | from voltage supply                               |                              | no  |
|                                       | between digital inputs                            |                              | no  |
|                                       | from the outputs                                  |                              | yes   |
|                                       | from PC interface, memory module, CL-NET, CL-LINK |                              | no  |
| Rated operational voltage $U_o$       |   | 24 V DC                      |   |
|                                       | $U_o$ on „0“ signal                               | < 5 V DC (I1-I12, R1-R12)    | 0-40 V AC (sinusoidal)  |
|                                       | $U_o$ on „1“ signal                               | -                            | 79-264 V AC (sinusoidal)  |
| Rated frequency                       |   | -                            | 50-60 Hz  |
| Input current on „1“ signal           |   | 3.3 mA (at 24 V DC, R1-R12)  | 12x0.25 mA<br>(at 115 V AC, 60 Hz, R1-R12),<br>12x0.5 mA<br>(at 230 V AC, 50 Hz, R1-R12)          |
| Time delay from „0“ to „1“            | debounce ON                                       | 20 ms                        | 80 ms (at 50 Hz, I1-I12, R1-R12),<br>66 <sup>2</sup> / <sub>3</sub> ms (at 60 Hz, I1-I12, R1-R12) |
|                                       | debounce OFF                                      | typ. 0.25 ms (R1-R12)        | 20 ms (at 50 Hz, I1-I12, R1-R12),<br>16 <sup>2</sup> / <sub>3</sub> ms (at 60 Hz, I1-I12, R1-R12) |
| Time delay from „1“ to „0“            | debounce ON                                       | 20 ms                        | 80 ms (at 50 Hz, I1-I12, R1-R12),<br>66 <sup>2</sup> / <sub>3</sub> ms (at 60 Hz, I1-I12, R1-R12) |
|                                       | debounce OFF                                      | -                            | 20 ms (at 50 Hz, I1-I12, R1-R12),<br>16 <sup>2</sup> / <sub>3</sub> ms (at 60 Hz, I1-I12, R1-R12) |
| Cable length (unshielded)             |   | 100 m                        | -   |
| Maximum cable length per input        |   | -                            | typ. 40 m (I1-I6, I9-I12, R1-R12),<br>typ. 100 m (I7, I8)   |

6



# Logic relays

## Technical data

Data at  $T_a = 25\text{ °C}$  and rated values, if nothing else indicated.

| Type   | CL-LSR...  | CL-LMR...<br>CL-LER...   | CL-LER.20 |
|--|--|--------------------------|-----------|
| <b>Output circuit - Relay outputs</b>              |  |                          |           |
| Number   | 4  | 6                        | 2         |
| Outputs in groups of                               | 1  |                          | 2         |
| Parallel switching of outputs to increase capacity | not permissible  |                          |           |
| Fusing of the output relay                         | circuit-breaker B16 or fuse 8 A (slow-acting)                                      |                          |           |
| Electrical isolation                               | from voltage supply  | yes                      |           |
|  | from the inputs  | yes                      |           |
|  | from PC interface, memory module, CL-NET, CL-LINK                                  | no                       |           |
|  | protective separation  | 300 V AC                 |           |
|  | basic isolation  | 600 V AC                 |           |
| Mechanical lifetime                                | 10x10 <sup>6</sup> switching cycles  |                          |           |
| Rung   | conventional thermal current (10 A UL)   | 8 A                      |           |
|  | recommended for load 12 V AC/DC  | > 500 mA                 |           |
|  | short-circuit proof $\cos \varphi = 1$ ;<br>characteristic B16 at 600 A            | 16 A                     |           |
|  | short-circuit proof $\cos \varphi = 0.5$ up to 0.7;<br>characteristic B16 at 900 A | 16 A                     |           |
|  | Rated impulse withstand voltage $U_{imp}$ contact-coil                             | 6 kV                     |           |
|  | Rated operational voltage $U_a$  | 250 V AC                 |           |
| Rated insulation voltage $U_i$                     | 250 V AC   |                          |           |
| Protective separation (EN 50178)                   | between coil and contact   | 300 V AC                 |           |
|  | between two contacts   | 300V AC                  |           |
| Making capacity                                    | AC15, 250 V AC, 3 A (600 ops./h)   | 300.000 switching cycles |           |
|  | DC13, L/R ≤ 150 ms, 24 V DC, 1 A (500 ops./h)                                      | 200.000 switching cycles |           |
| Breaking capacity                                  | AC15, 250 V AC, 3 A (600 ops./h)   | 300.000 switching cycles |           |
|  | DC13, L/R ≤ 150 ms, 24 V DC, 1 A (500 ops./h)                                      | 200.000 switching cycles |           |
| Incandescent lamp load                             | 1000 W at 230/240 V AC   | 25.000 switching cycles  |           |
|  | 500 W at 115/120 V AC  | 25.000 switching cycles  |           |
| Fluorescent lamp load                              | 10 x 58 W at 230/240 V AC<br>with electrical control gear                          | 25.000 switching cycles  |           |
|  | 10 x 58 W at 230/240 V AC<br>uncompensated   | 25.000 switching cycles  |           |
|  | 1 x 58 W at 230/240 V AC<br>conventional compensated                               | 25.000 switching cycles  |           |
|  |  |                          |           |
| Switching frequency                                | mechanical operations  | 10x10 <sup>6</sup>       |           |
|  | switching frequency  | 10 Hz                    |           |
|  | resistive load / lamp load   | 2 Hz                     |           |
|  | inductive load   | 0.5 Hz                   |           |
| <b>UL/CSA</b>                                      |  |                          |           |
| Continuous current at 240 V                        |  | 10 A AC                  |           |
| Continuous current at 24 V                         |  | 8 A DC                   |           |
| AC   | Utilization category (Control Circuit Rating Codes)                                | B 300 Light Pilot Duty   |           |
|  | max. rated operational voltage   | 300 V AC                 |           |
|  | max. continuous thermal current $\cos \varphi = 1$ at B 300                        | 5 A                      |           |
|  | max. making / breaking apparent power (Make/Break) $\cos \varphi \neq 1$ at B 300  | 3600/360 VA              |           |
| DC   | Utilization category (Control Circuit Rating Codes)                                | R 300 Light Pilot Duty   |           |
|  | max. rated operational voltage   | 300 V DC                 |           |
|  | max. continuous thermal current at R 300   | 1 A                      |           |
|  | max. making / breaking apparent power (Make/Break) at R 300                        | 28/28 VA                 |           |

Data at  $T_a = 25\text{ °C}$  and rated values, if nothing else indicated.

| Type   | CL-LST...  | CL-LMT...   | CL-LET...                         |
|--|--|---|-----------------------------------|
| <b>Output circuit - Transistor outputs</b>   |  |   |                                   |
| Number   | 4  | 8   |                                   |
| Rated operational voltage $U_o$  | 24 V DC  |   |                                   |
| Operational voltage range  | 20.4-28.8 V DC   |   |                                   |
| Residual ripple  | ≤ 5 %  |   |                                   |
| Supply current   | on „0“ signal  | typ. 9 mA /<br>max. 16 mA   | typ. 18 mA /<br>max. 32 mA        |
|  | on „1“ signal  | typ. 12 mA /<br>max. 22 mA  | typ. 24 mA /<br>max. 44 mA        |
| Reverse voltage protection   | yes (Attention: If supply voltage is reversed, applying voltage at the outputs, causes a short circuit.) |   |                                   |
| Electrical isolation   | from voltage supply  | yes   |                                   |
|  | from the inputs  | yes   |                                   |
|  | from PC interface, memory module, CL-NET, CL-LINK  | -   |                                   |
| Rated operational current $I_o$ on „1“ signal DC   | max. 0.5 A   |   |                                   |
| Lamp load without $R_f$  | 5 W  |   |                                   |
| Residual current on „0“ signal per channel   | < 0.1 mA   |   |                                   |
| Max. output voltage  | on „0“ signal at external load < 10 MΩ   | 2.5 V   |                                   |
|  | on „1“ signal at $I_o = 0.5\text{ A}$  | $U = U_o - 1\text{ V}$  |                                   |
| Short-circuit protection   | yes, thermal (analysis results from diagnosis input I16, I15; R15, R16)                                  |   |                                   |
| Short-circuit tripping current for $R_f \leq 10\text{ m}\Omega$  | $0.7\text{ A} \leq I_o \leq 2\text{ A}$ per output   |   |                                   |
| Total short-circuit current  | 8 A  | 16 A  |                                   |
| Peak short-circuit current   | 16 A   | 32 A  |                                   |
| Thermal tripping   | yes  |   |                                   |
| Max. switching frequency with constant resistive load $R_L < 100\text{ k}\Omega$ (depending on active channels and their load) | 40.000 switching cycles/h  |   |                                   |
| Parallel connection of outputs   | with resistive load, inductive load with external suppressor, combination within one group               | group 1: Q1-Q4  | group 1: Q1-Q4,<br>group 2: Q5-Q8 |
|  | number of outputs  | max. 4  |                                   |
|  | max. total current   | 2 A (Attention! Outputs must be actuated simultaneously and for the same length of time.) |                                   |
| Indication of operational states of the outputs  | LCD-Display (if existing)  |   |                                   |
| Inductive load <sup>1)</sup> without external suppressor   |  |   |                                   |
| $T_{0.95} = 1\text{ ms}$ ,<br>$R = 48\ \Omega$ ,<br>$L = 16\text{ mH}$   | utilization factor   | 0.25 g  |                                   |
|  | duty time  | 100 %   |                                   |
|  | max. switching frequency $f = 0.5\text{ Hz}$<br>(max. duty time = 50 %)                                  | 1500 switching cycles   |                                   |
| DC13,<br>$T_{0.95} = 72\text{ ms}$ ,<br>$R = 48\ \Omega$ ,<br>$L = 1.15\text{ H}$  | utilization factor   | 0.25 g  |                                   |
|  | duty time  | 100 %   |                                   |
|  | max. switching frequency $f = 0.5\text{ Hz}$<br>(max. duty time = 50 %)                                  | 1500 switching cycles   |                                   |
| $T_{0.95} = 15\text{ ms}$ ,<br>$R = 48\ \Omega$ ,<br>$L = 0.24\text{ H}$   | utilization factor   | 0.25 g  |                                   |
|  | duty time  | 100 %   |                                   |
|  | max. switching frequency $f = 0.5\text{ Hz}$<br>(max. duty time = 50 %)                                  | 1500 switching cycles   |                                   |
| Inductive load <sup>1)</sup> with external suppressor  |  |   |                                   |
|  | demand factor  | 1 g   |                                   |
|  | duty time  | 100 %   |                                   |
|  | max. switching frequency   | depends on suppressor   |                                   |
|  | max. duty time   |   |                                   |

<sup>1)</sup> For inductive loading, without external suppression of the transistor outputs, the following applies:  
 $T_{0.95}$  = time in ms, until 95 % of the steady-state current is achieved.  $T_{0.95} \cdot 3 \times T_{0.65} = 3 \times L/R$ .

Data transfer rate in the CL-NET network: bus lengths of 40 m and over only attainable with cables with additional cross-section and connection adapter.

# Logic relays

## Technical data

CL Range  
Logic relays

Data at  $T_a = 25\text{ °C}$  and rated values, if nothing else indicated.

| Type  | CL-LSR..., CL-LST...  | CL-LMR... CL-LMT..<br>CL-LET., CL-LER.18..  | CL-LER.20<br>CL-LEC.CI000                                      |
|---|---|---|--|
| <b>General data</b>   |   |   |  |
| Dimensions (W x H x D)  | 71.5 mm x 90 mm x 58 mm<br>(2.81 inch x 3.54 inch x 2.28 inch)                                      | 107.5 mm x 90 mm x 58 mm<br>(4.23 inch x 3.54 inch x 2.28 inch)                       | 35.5 mm x 90 mm x 58 mm<br>(1.40 inch x 3.54 inch x 2.28 inch) |
| Weight  | 0.2 kg (0.44 lb)  | 0.3 kg (0.66 lb)  | 0.07 kg (0.15 lb)  |
| Mounting  | DIN rail (IEC/EN 60715),<br>35 mm or screw mounting with fixing brackets CL-LAS.FD001 (accessories) |   |  |
| Mounting position   | horizontal / vertical   |   |  |
| <b>Electrical connection</b>                                  |   |   |  |
| Wire size   | rigid<br>fine-strand with wire end ferrule  | 0.2-4 mm <sup>2</sup> (22-12 AWG)<br>0.2-2.5 mm <sup>2</sup> (22-12 AWG)              |  |
| Max. tightening torque  | 0.6 Nm  |   |  |
| <b>Environmental data</b>                                     |   |   |  |
| Ambient temperature range                                     | operation<br>storage  | -25...+55 °C, cold acc. to IEC 60068-2-1, heat acc. to IEC 60068-2-2<br>-40...+70 °C  |  |
| LCD-Display (clearly legible)                                 | 0...+55 °C  |   |  |
| Condensation  | avoid condensation with suitable methods  |   |  |
| Humidity, no condensation (IEC/EN 60068-2-30)                 | 5-95 %  |   |  |
| Air pressure (operation)                                      | 795-1080 hPa  |   |  |
| Degree of protection (IEC/EN 60529)                           | IP20  |   |  |
| Vibration (IEC/EN 60068-2-6)                                  | 10-57 Hz (constant amplitude 0.15 mm), 57-150 Hz (constant acceleration 2 g)                        |   |  |
| Shock resistance (half-sine 15 g / 11 ms) (IEC/EN 60068-2-27) | 18 Shocks   |   |  |
| Drop (IEC/EN 60068-2-31) height of fall                       | 50 mm   |   |  |
| Free fall, packaged (IEC/EN 60068-2-32)                       | 1 m   |   |  |
| <b>Insulation data</b>  |   |   |  |
| Overvoltage category  | II  |   |  |
| Pollution degree (DIN EN 60947)                               | 2   |   |  |
| Rating of air and creepage distances                          | EN 50178, UL 508, CSA C22.2, No. 142  |   |  |
| Insulation resistance   | EN 50178  |   |  |
| <b>Standards</b>  |   |   |  |
| Standards and directives                                      | EN 55011, EN 55022, IEC/EN 61000-4, IEC 60068-2-6, IEC 60068-2-27                                   |   |  |
| <b>Electromagnetic compatibility</b>                          |   |   |  |
| Interference immunity   |   |   |  |
| electrostatic discharge (ESD)                                 | IEC/EN 61000-4-2  | Level 3 (air discharge 8 kV, contact discharge 6 kV)                                  |  |
| electromag. field (HF radiation resistance)                   | IEC/EN 61000-4-3  | 10 V/m  |  |
| fast transients (Burst)                                       | IEC/EN 61000-4-4  | Level 3 (supply cable 2 kV, signal lines 2 kV)  |  |
| powerful impulses (Surge)                                     | IEC/EN 61000-4-5  | supply cable symmetrical (AC) 2 kV,<br>Level 2 (supply cable symmetrical (DC) 0.5 kV) |  |
| HF line emission  | IEC/EN 61000-4-6  | 10 V  |  |
| Interference suppression (EN 55011, EN 55022)                 | class B   |   |  |
| <b>Real time clock</b>  |   |   |  |
| Back-up time  | see diagram   |   | -  |
| Accuracy  | typ. ±5 (±0.5 h/year)   |   | -  |
| <b>Repeat accuracy of the time relay</b>                      |   |   |  |
| Accuracy (from value)   | ±1  |   | -  |
| Resolution  | range „S“   | 10 ms   | -  |
|   | range „M:“  | 1 s   | -  |
|   | range „H:M“   | 1 min   | -  |
| <b>Retention behaviour</b>                                    |   |   |  |
| Write cycles of retention memory (minimum)                    | 1.000.000 (10 <sup>6</sup> )  |   | -  |

### Technical diagram

#### Back-up time of the real time clock

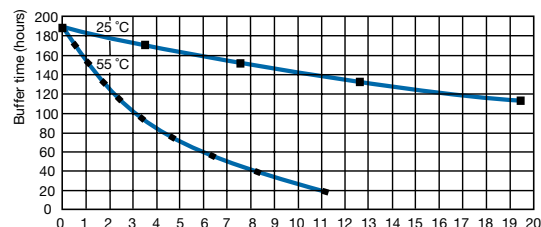

Data at  $T_a = 25\text{ °C}$  and rated values, if nothing else indicated.

| Type  |                  | CL-LDD...   |
|---|------------------|---|
| <b>Input circuit - Supply circuit</b>                         |                  |   |
| Power failure buffering (IEC/EN 61131-2)                      |                  | 10 ms   |
| <b>General data</b>   |                  |   |
| Dimensions (W x H x D)  |                  | with keypad:<br>86.5 x 86.5 x 21.5 mm (3.41 x 3.41 x 0.85 inch)<br>without keypad:<br>86.5 x 86.5 x 20 mm (3.41 x 3.41 x 0.79 inch) |
| 6 Weight  |                  | 0.13 kg (0.29 lb)   |
| Mounting  |                  | 2 x 22.5 mm, with 2 retainers screwed   |
| Mounting position   |                  | horizontal / vertical   |
| <b>Environmental data</b>                                     |                  |   |
| Ambient temperature range                                     | operation        | -25...+55 °C (cold acc. to IEC 60068-2-1, heat acc. to IEC 60068-2-2)   |
|   | storage          | -40...+70 °C  |
| LCD-Display (clearly legible)                                 |                  | -5...+50 °C,<br>-10...0 °C (with backlit / continuous operation)  |
| Condensation  |                  | avoid condensation with suitable methods  |
| Humidity, no condensation (IEC/EN 60068-2-30)                 |                  | 5-95 %  |
| Air pressure (operation)                                      |                  | 795-1080 hPa  |
| Degree of protection (IEC/EN 60529)                           |                  | IP65  |
| Vibration (IEC/EN 60068-2-6)                                  |                  | 10-57 Hz (constant amplitude 0.15 mm), 57-150 Hz (constant acceleration 2 g)  |
| Shock resistance (half-sine 15 g / 11 ms) (IEC/EN 60068-2-27) |                  | 18 Shocks   |
| Drop (IEC/EN 60068-2-31) height of fall                       |                  | 50 mm   |
| Free fall, packaged (IEC/EN 60068-2-32)                       |                  | 1 m   |
| <b>Insulation data</b>  |                  |   |
| Pollution degree (DIN EN 60947)                               |                  | 3   |
| Rating of air and creepage distances                          |                  | EN 50178, UL 508, CSA 22.2, No 142  |
| Insulation resistance   |                  | EN 50178  |
| <b>Standards</b>  |                  |   |
| Standards and directives                                      |                  | EN 61000-6-1, EN 61000-6-2, EN 61000-6-3, EN 61000-6-4,<br>IEC 60068-2-6, IEC 60068-2-27  |
| <b>Electromagnetic compatibility</b>                          |                  |   |
| Interference immunity   |                  |   |
| electrostatic discharge (ESD)                                 | IEC/EN 61000-4-2 | Level 3 (air discharge 8 kV, contact discharge 6 kV)  |
| electromag. field (HF radiation resistance)                   | IEC/EN 61000-4-3 | 10 V/m  |
| fast transients (Burst)                                       | IEC/EN 61000-4-4 | Level 3 (supply cable 2 kV, signal lines 2 kV)  |
| powerful impulses (Surge)                                     | IEC/EN 61000-4-5 | Level 3 (supply cable symmetrical 2 kV, CL-LDC.L...AC2)<br>Level 2 (0.5 kV supply cable symmetrical, CL-LDC.L...AC2)                |
| HF line emission  | IEC/EN 61000-4-6 | 10 V  |
| Interference suppression (EN 55011, EN 55022)                 |                  | class B   |

# Logic relays

## Technical data

Data at  $T_a = 25\text{ °C}$  and rated values, if nothing else indicated.

| Type  | CL-LDC.<br>SDC2  | CL-LDC.<br>SAC2   | CL-LDC.<br>LDC2                                      | CL-LCD.<br>LAC2 | CL-LDC.<br>LNDC2                                      | CL-LDC.<br>LNAC2 |
|---|--|---|--|-----------------|---|------------------|
| <b>Input circuit - Supply circuit</b>         |  |   |  |                 |   |                  |
| Rated operational voltage $U_o$               | 24 V DC  | 100-240 V AC  | 24 V DC  | 100-240 V AC    | 24 V DC   | 100-240 V AC     |
| Rated operational voltage tolerance           | -15...+20 %  | -15...+10 %   | -15...+20 %  | -15...+10 %     | -15...+20 %   | -15...+10 %      |
| Operational voltage range                     | 20.4-28.8 V DC   | 85-264 V AC   | 20.4-28.8 V DC                                       | 85-264 V AC     | 20.4-28.8 V DC  | 85-264 V AC      |
| Frequency                                     | 0 Hz   | 50/60 Hz  | 0 Hz   | 50/60 Hz        | 0 Hz  | 50/60 Hz         |
| Frequency tolerance                           | -  | ± 5 %   | -  | ± 5 %           | -   | ± 5 %            |
| Residual ripple                               | ≤ 5 %  | -   | ≤ 5 %  | -               | ≤ 5 %   | -                |
| Input current                                 | at 24 V DC<br>typ. 185 mA  | -   | typ. 200 mA  | -               | typ. 200 mA   | -                |
|   | at 115/120 V AC (60 Hz)  | typ. 90 mA  | -  | typ. 90 mA      | -   | typ. 90 mA       |
|   | at 230/240 V AC (50 Hz)  | typ. 60 mA  | -  | typ. 60 mA      | -   | typ. 60 mA       |
| Power failure buffering (IEC/EN 61131-2)      | 10 ms  |   |  |                 |   |                  |
| Power dissipation                             | at 24 V DC<br>1.5 W  | -   | 3.4 W  | -               | 3.4 W   | -                |
|   | at 115/120 V AC  | typ. 11 VA  | -  | typ. 11 VA      | -   | typ. 11 VA       |
|   | at 230/240 V AC  | typ. 15 VA  | -  | typ. 15 VA      | -   | typ. 15 VA       |
| <b>Network - point-to-point connection</b>    |  |   |  |                 |   |                  |
| Number of stations                            | 1  |   | -  |                 |   |                  |
| Data transfer rate                            | CL-LS..., CL-LM...   | 9.6 kBaud   | -  |                 |   |                  |
|   | CL-LDD   | 19.2 kBaud  | -  |                 |   |                  |
| Distance                                      | max. 5 m   |   |  |                 |   |                  |
| Electrical isolation                          | to voltage supply  | yes   | -  |                 |   |                  |
|   | to connected device  | yes   | -  |                 |   |                  |
| Termination system                            | spring-type terminal   |   |  |                 |   |                  |
| <b>Network - CL-NET</b>                       |  |   |  |                 |   |                  |
| Number of stations                            | max. 1   |   | -  |                 | max. 8  |                  |
| Data transfer rate                            | 6 m  | -   | -  |                 | 1000 kBit/s   |                  |
|   | 25 m   | -   | -  |                 | 500 kBit/s  |                  |
|   | 40 m   | -   | -  |                 | 250 kBit/s  |                  |
|   | 125 m  | -   | -  |                 | 125 kBit/s  |                  |
|   | 300 m  | -   | -  |                 | 50 kBit/s   |                  |
|   | 700 m  | -   | -  |                 | 20 kBit/s   |                  |
|   | 1000 m   | -   | -  |                 | 10 kBit/s   |                  |
| Electrical isolation                          | to voltage supply  | -   | -  |                 | yes   |                  |
|   | to inputs  | -   | -  |                 | yes   |                  |
|   | to outputs   | -   | -  |                 | yes   |                  |
|   | to PC interface, memory module, CL-NET, CL-LINK                              | -   | -  |                 | yes   |                  |
| Bus terminator (first and last station)       | -  |   |  |                 |   |                  |
| Termination system                            | RJ45, 8 pole   |   |  |                 |   |                  |
| <b>General data</b>                           |  |   |  |                 |   |                  |
| Dimensions (W x H x D)                        | 75 x 58 x 36.2 mm<br>(2.95 x 2.28 x 1.43 inch)                               |   | 107.5 x 90 x 30 mm<br>(4.23 x 3.54 x 1.18 inch)      |                 |   |                  |
| Weight  | 0.164 kg (0.36 lb)   |   | 0.145 kg (0.32 lb)                                   |                 |   |                  |
| Mounting                                      | plugged onto CL-LDD  |   | plugged onto CL-LDD or<br>on DIN rail (IEC/EN 60715) |                 |   |                  |
| Mounting position                             |  |   |  |                 |   |                  |
| <b>Electrical connection - Supply circuit</b> |  |   |  |                 |   |                  |
| Wire size                                     | fine-strand with wire end ferrule  | 0.2 mm <sup>2</sup> / 2.5 mm <sup>2</sup> (24-12 AWG)                 |  |                 |   |                  |
|   | rigid  | 0.2 mm <sup>2</sup> / 4 mm <sup>2</sup> (24-12 AWG)                   |  |                 |   |                  |
| <b>Electrical connection - Data cable</b>     |  |   |  |                 |   |                  |
| Wire size                                     | fine-strand with wire end ferrule  | 0.08 mm <sup>2</sup> / 1.5 mm <sup>2</sup> (28-12 AWG)                | -  |                 | 0.2 mm <sup>2</sup> / 2.5 mm <sup>2</sup> (24-12 AWG) |                  |
|   | rigid  | 0.08 mm <sup>2</sup> / 2.5 mm <sup>2</sup> (28-12 AWG)                | -  |                 | 0.2 mm <sup>2</sup> / 4 mm <sup>2</sup> (24-12 AWG)   |                  |
| <b>Environmental data</b>                     |  |   |  |                 |   |                  |
| Ambient temperature range                     | operation  | -25...+55 °C (cold acc. to IEC 60068-2-1, heat acc. to IEC 60068-2-2) |  |                 |   |                  |
|   | storage  | -40...+70 °C  |  |                 |   |                  |
| Condensation                                  | avoid condensation with suitable methods                                     |   |  |                 |   |                  |
| Humidity, no condensation (IEC/EN 60068-2-30) | 5-95 %   |   |  |                 |   |                  |
| Air pressure (operation)                      | 795-1080 hPa   |   |  |                 |   |                  |
| Degree of protection (IEC/EN 60529)           | IP20   |   |  |                 |   |                  |
| Vibration (IEC/EN 60068-2-6)                  | 10-57 Hz (constant amplitude 0.15 mm), 57-150 Hz (constant acceleration 2 g) |   |  |                 |   |                  |

Data at  $T_a = 25\text{ °C}$  and rated values, if nothing else indicated.

| Type   | CL-LDC.<br>SDC2  | CL-LDC.<br>SAC2 | CL-LDC.<br>LDC2                         | CL-LCD.<br>LAC2 | CL-LDC.<br>LNDC2 | CL-LDC.<br>LNAC2  |
|--|------------------|-----------------|---|-----------------|------------------|---|
| Shock (half-sine 15 g / 11 ms) (IEC/EN 60068-2-27) |                  |                 |   |                 |                  | 18 Shocks   |
| Drop (IEC/EN 60068-2-31) height of fall            |                  |                 |   |                 |                  | 50 mm   |
| Free fall, packaged (IEC/EN 60068-2-32)            |                  |                 |   |                 |                  | 1 m   |
| <b>Insulation data</b>                             |                  |                 |   |                 |                  |   |
| Degree of protection (DIN EN 60947)                |                  |                 |   |                 |                  | 2   |
| Rating of air and creepage distances               |                  |                 |   |                 |                  | EN 50178, UL 508, CSA 22.2, No 142  |
| Isolation resistance                               |                  |                 |   |                 |                  | EN 50178  |
| <b>Standards</b>                                   |                  |                 |   |                 |                  |   |
| Standards and directives                           |                  |                 |   |                 |                  | EN 61000-6-1, EN 61000-6-2, EN 61000-6-3, EN 61000-6-4, IEC 60068-2-6, IEC 60068-2-27 |
| <b>Electromagnetical compatibility</b>             |                  |                 |   |                 |                  |   |
| Interference immunity                              |                  |                 |   |                 |                  |   |
| electrostatic discharge (ESD)                      | IEC/EN 61000-4-2 |                 |   |                 |                  | Level 3 (air discharge 8 kV, contact discharge 6 kV)                                  |
| electromag. field (HF radiation resistance)        | IEC/EN 61000-4-3 |                 |   |                 |                  | 10 V/m  |
| fast transients (Burst)                            | IEC/EN 61000-4-4 |                 |   |                 |                  | Level 3 (supply cable 2 kV, signal lines 2 kV)  |
| powerful impulses (Surge)                          | IEC/EN 61000-4-5 |                 |   |                 |                  | Level 3 (supply cable symmetrical 2 kV, CL-LDC.L...AC2)                               |
|  |                  |                 | Level 2 (1 kV supply cable symmetrical) |                 |                  | Level 2 (0.5 kV supply cable symmetrical, CL-LDC.L...AC2)                             |
| HF line emission                                   | IEC/EN 61000-4-6 |                 |   |                 |                  | 10 V  |
| Interference suppression (EN 55011, EN 55022)      |                  |                 |   |                 |                  | class B   |
| <b>Real time clock</b>                             |                  |                 |   |                 |                  |   |
| Back-up time                                       |                  |                 |   |                 |                  | see diagram   |
| Accuracy   |                  |                 |   |                 |                  | typ. $\pm 5$ s/day ( $\pm 0,5$ h/year)  |
| <b>Repeat accuracy of the time relay</b>           |                  |                 |   |                 |                  |   |
| Accuracy (from value)                              |                  |                 |   |                 |                  | $\pm 0,02\%$  |
| Resolution   | range „S“        |                 |   |                 |                  | 5 ms  |
|  | range „M:S“      |                 |   |                 |                  | 1 s   |
|  | range „H:M“      |                 |   |                 |                  | 1 min   |
| <b>Retention behaviour</b>                         |                  |                 |   |                 |                  |   |
| Write cycles of retention memory (minimum)         |                  |                 |   |                 |                  | $10^{10}$ (read/ write cycles)  |

## Technical diagram

### Back-up time of the real time clock

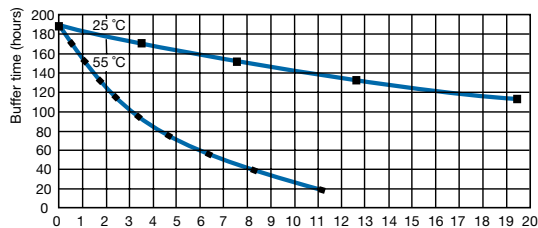

# Logic relays

## Technical data

Data at  $T_a = 25\text{ °C}$  and rated values, if nothing else indicated.

| Type                                  |   | CL-LD...16DC2   | CL-LD...17DC2 | CL-LDR.16AC2  |
|---------------------------------------|---|---|---------------|---|
| <b>Input circuit - Digital inputs</b> |   | 24 V DC   |               | 115/230 V   |
| Number                                |   | 12  |               |   |
| Inputs can be used as analog inputs   |   | 4 (I7, I8, I11, I12)  |               | -   |
| Indication of operational states      |   | -   |               | LCD-Display (if existing)   |
| Electrical isolation                  | from supply voltage                               |   |               | no  |
|                                       | from digital inputs                               |   |               | no  |
|                                       | from the outputs                                  |   |               | yes   |
|                                       | from PC interface, memory module, CL-NET, CL-LINK |   |               | yes   |
| Rated operational voltage $U_o$       |   | 24 V DC   |               | -   |
|                                       | $U_o$ on „0“ signal                               | < 5 V DC (I1-I6, I9, I10), < 8 V DC (I7, I8, I11, I12)                                |               | 0-40 V AC (sinusoidal)  |
|                                       | $U_o$ on „1“ signal                               | > 15 V DC (I1-I6, I9, I10), > 8 V DC (I7, I8, I11, I12)                               |               | 79-264 V AC (sinusoidal)  |
| Rated frequency                       |   | 0 Hz  |               | 50-60 Hz  |
| Input current on „1“ signal           |   | 3.3 mA (at 24 V DC, I1-I6, I9, I10),<br>2.2 mA (at 24 V DC, I7, I8, I11, I12)         |               | 12x0.2 mA<br>(at 115 V AC, 60 Hz, I1-I12),<br>12x0.5 mA<br>(at 230 V AC, 50 Hz, I1-I12) |
|                                       |   |   |               |   |
| Time delay from „0“ to „1“            | debounce ON                                       | 20 ms   |               | 10 ms (at 50 Hz),<br>100 ms (at 60 Hz)  |
|                                       | debounce OFF                                      | typ. 0.1 ms (I1-I4), typ. 0.25 ms (I5-I12)  |               | 10 ms (at 50 Hz),<br>100 ms (at 60 Hz)  |
| Time delay from „1“ to „0“            | debounce ON                                       | 20 ms   |               | 10 ms (at 50 Hz),<br>100 ms (at 60 Hz)  |
|                                       | debounce OFF                                      | typ. 0.1 ms (I1-I4), typ. 0.4 ms (I5, I6, I9, I10),<br>typ. 0.2 ms (I7, I8, I11, I12) |               | 10 ms (at 50 Hz),<br>100 ms (at 60 Hz)  |
| Cable length (unshielded)             |   | 100 m   |               | -   |
| Maximum cable length per input        |   | -   |               | typ. 60 m   |
| Frequency counter                     | number  | 4 (I1, I2, I3, I4)  |               | -   |
|                                       | counting frequency                                | < 3 kHz   |               | -   |
|                                       | pulse shape                                       | square-wave   |               | -   |
|                                       | pulse / pause ratio                               | 1:1   |               | -   |
| Incremental counter                   | number  | 2 (I1 + I2, I3 + I4)  |               | -   |
|                                       | counting frequency                                | < 3 kHz   |               | -   |
|                                       | pulse shape                                       | square-wave   |               | -   |
|                                       | signal offset                                     | 90°   |               | -   |
| Rapid counter inputs                  | number  | 4 (I1, I2, I3, I4)  |               | -   |
|                                       | counting frequency                                | < 3 kHz   |               | -   |
|                                       | pulse shape                                       | square-wave   |               | -   |
|                                       | pulse / pause ratio                               | 1:1   |               | -   |
| Cable length (shielded)               |   | < 20 m  |               | -   |
| <b>Input circuit - Analog inputs</b>  |   |   |               |   |
| Number                                |   | 4 (I7, I8, I11, I12)  |               | -   |
| Electrical isolation                  | to voltage supply                                 | no  |               | -   |
|                                       | to digital inputs                                 | no  |               | -   |
|                                       | to outputs  | yes   |               | -   |
|                                       | to PC interface, memory modul, CL-NET, CL-LINK    | yes   |               | -   |
| Input type                            |   | DC voltage  |               | -   |
| Signal range                          |   | 0-10 V DC   |               | -   |
| Resolution                            | analog  | 0.01 V  |               | -   |
|                                       | digital   | 0.01 V; 10 Bit (value 0-1023)   |               | -   |
| Input impedance                       |   | 11.2 k $\Omega$   |               | -   |
| Accuracy of the actual value          | two CL-LD... devices                              | $\pm 3\%$   |               | -   |
|                                       | within one device                                 | $\pm 2\%$   |               | -   |
| Conversion time analog/digital        |   | each cycle  |               | -   |
| Input current                         |   | < 1 mA  |               | -   |
| Cable length (shielded)               |   | < 30 m  |               | -   |

Data at  $T_a = 25\text{ °C}$  and rated values, if nothing else indicated.

| Type   |   | CL-LD...16DC2   | CL-LD...17DC2           | CL-LDR.16AC2             |
|--|---|---|-------------------------|--------------------------|
| <b>Output circuit - Analog outputs</b>             |   |   |                         |                          |
| Number   |   | -   | 1                       | -                        |
| Electrical separation                              | from voltage supply                               | -   | no                      | -                        |
|  | from the digital inputs                           | -   | no                      | -                        |
|  | from the digital outputs                          | -   | yes                     | -                        |
|  | from PC interface, memory module, CL-NET, CL-LINK | -   | yes                     | -                        |
| Output type  |   | -   | DC voltage              | -                        |
| Signal range                                       |   | -   | 0-10 V DC               | -                        |
| Max. output current                                |   | -   | 0.01 A                  | -                        |
| Burden resistance                                  |   | -   | 1 k $\Omega$            | -                        |
| Overload and short-circuit protection              |   | -   | yes                     | -                        |
| Resolution   | analog  | -   | 0.01 V DC               | -                        |
|  | digital   | -   | 10 Bit, (value: 0-1023) | -                        |
| Setting time                                       |   | -   | 100 ms                  | -                        |
| Accuracy   | -25...+55 °C                                      | -   | 2 %                     | -                        |
|  | 25 °C   | -   | 1 %                     | -                        |
| Conversion time                                    |   | -   | each CPU cycle          | -                        |
| <b>General data</b>                                |   |   |                         |                          |
| Dimensions (W x H x D)                             |   | CL-LDR: 89 x 90 x 44 mm (3.5 x 3.54 x 1.73 inch)                              |                         | 89 x 90 x 44 mm          |
|  |   | CL-LDT (build-in): 89 x 90 x 25 mm (3.5 x 3.54 x 0.98 inch)                   |                         | (3.5 x 3.54 x 1.73 inch) |
| Weight   |   | CL-LDR: 0.15 kg (0.33 lb) / CL-LDT: 0.14 kg (0.31 lb)                         |                         | 0.15 kg (0.33 lb)        |
| Mounting   |   | snap-on power supply unit   |                         |                          |
| Mounting position                                  |   | horizontal / vertical   |                         |                          |
| <b>Electrical connection</b>                       |   |   |                         |                          |
| Wire size  | fine-strand with wire end ferrule                 | 0.2 mm <sup>2</sup> / 2.5 mm <sup>2</sup> (24-12 AWG)                         |                         |                          |
|  | rigid   | 0.2 mm <sup>2</sup> / 4 mm <sup>2</sup> (24-12 AWG)                           |                         |                          |
| <b>Electrical connection - Data cable</b>          |   |   |                         |                          |
| Wire size  | fine-strand with wire end ferrule                 | 0.08 mm <sup>2</sup> / 1.5 mm <sup>2</sup> (28-12 AWG)                        |                         |                          |
|  | rigid   | 0.08 mm <sup>2</sup> / 2.5 mm <sup>2</sup> (28-12 AWG)                        |                         |                          |
| <b>Environmental data</b>                          |   |   |                         |                          |
| Ambient temperature range                          | operation   | -25...+55 °C (cold acc. to IEC 60068-2-1, heat acc. to IEC 60068-2-2)         |                         |                          |
|  | storage   | -40...+70 °C  |                         |                          |
| Condensation                                       |   | avoid condensation with suitable methods                                      |                         |                          |
| Humidity, no condensation (IEC/EN 60068-2-30)      |   | 5-95 %  |                         |                          |
| Atmospheric pressure (operation)                   |   | 795-1080 hPa  |                         |                          |
| Degree of protection (IEC/EN 60529)                |   | IP20  |                         |                          |
| Vibration (IEC/EN 60068-2-6)                       |   | 10-57 Hz (constant amplitude 0.15 mm), 57-150 Hz (constant acceleration 2 g)  |                         |                          |
| Shock (half-sine 15 g / 11 ms) (IEC/EN 60068-2-27) |   | 18 Shocks   |                         |                          |
| Drop (IEC/EN 60068-2-31) height of fall            |   | 50 mm   |                         |                          |
| Free fall, packaged (IEC/EN 60068-2-32)            |   | 1 m   |                         |                          |
| <b>Insulation data</b>                             |   |   |                         |                          |
| Pollution degree                                   |   | 2   |                         |                          |
| Rating of air and creepage distances               |   | EN 50178, UL 508, CSA C22.2, No. 142  |                         |                          |
| Isolation resistance                               |   | EN 50178  |                         |                          |
| <b>Standards</b>                                   |   |   |                         |                          |
| Standards and directives                           |   | EN 61000-6-1/-2/-3/-4, IEC/EN 61000-4, IEC 60068-2-6, IEC 60068-2-27          |                         |                          |
| <b>Electromagnetic compatibility</b>               |   |   |                         |                          |
| electrostatic discharge (ESD)                      | IEC/EN 61000-4-2                                  | Level 3 (air discharge 8 kV, contact discharge 6 kV)                          |                         |                          |
| electromag. field (HF radiation res.)              | IEC/EN 61000-4-3                                  | 10 V/m  |                         |                          |
| fast transients (Burst)                            | IEC/EN 61000-4-4                                  | Level 3 (supply cable 2 kV, signal cable 2 kV)                                |                         |                          |
| powerful impulses (Surge)                          | IEC/EN 61000-4-5                                  | 2 kV (supply cable symmetrical),<br>Level 2 (0.5 kV supply cable symmetrical) |                         |                          |
| HF line emission                                   | IEC/EN 61000-4-6                                  | 10 V  |                         |                          |
| Interference suppression (EN 55011, EN 55022)      |   | class B   |                         |                          |



# Logic relays

## Technical data

Data at  $T_a = 25\text{ °C}$  and rated values, if nothing else indicated.

| Type   | CL-LDR...  |                          |
|--|--|--------------------------|
| <b>Output circuit - Relay outputs</b>              |  |                          |
| Number   | 4  |                          |
| Outputs in groups of                               | -  |                          |
| Parallel switching of outputs to increase capacity | not permissible  |                          |
| Fusing of the output relay                         | circuit-breaker B16 or fuse 8 A (slow-acting)  |                          |
| Electrical isolation                               | from voltage supply  | yes                      |
|  | from the inputs  | yes                      |
|  | from PC interface, memory module, CL-NET, CL-LINK                                    | yes                      |
|  | protective separation  | 300 V AC                 |
|  | Basic isolation  | 600 V AC                 |
| Mechanical lifetime                                | $10 \times 10^6$ switching cycles  |                          |
| Rung   | conventional thermal current (10 A UL)   | 8 A                      |
|  | recommended load 12 V AC/DC  | > 500 mA                 |
|  | short-circuit proof $\cos \varphi = 1$ ;<br>characteristic B16 at 600 A              | 16 A                     |
|  | short-circuit proof $\cos \varphi = 0.5$ up to 0.7;<br>characteristic B16 at 900 A   | 16 A                     |
|  | Rated impulse withstand voltage $U_{imp}$ contact-coil                               | 6 kV                     |
|  | Rated operational voltage $U_e$  | 250 V AC                 |
| Rated insulation voltage $U_i$                     | 250 V AC   |                          |
| Protective separation (EN 50178)                   | between coil and contact   | 300 V AC                 |
|  | between two contacts   | 300V AC                  |
| Making capacity                                    | AC15, 250 V AC, 3 A (600 ops./h)   | 300.000 switching cycles |
|  | DC13, L/R $\leq 150$ ms, 24 V DC, 1 A (500 ops./h)                                   | 200.000 switching cycles |
| Breaking capacity                                  | AC15, 250 V AC, 3 A (600 ops./h)   | 300.000 switching cycles |
|  | DC13, L/R $\leq 150$ ms, 24 V DC, 1 A (500 ops./h)                                   | 200.000 switching cycles |
| Incandescent lamp load                             | 1000 W at 230/240 V AC   | 25.000 switching cycles  |
|  | 500 W at 115/120 V AC  | 25.000 switching cycles  |
| Fluorescent lamp load                              | 10 x 58 W at 230/240 V AC<br>with electrical control gear                            | 25.000 switching cycles  |
|  | 10 x 58 W at 230/240 V AC<br>uncompensated   | 25.000 switching cycles  |
|  | 1 x 58 W at 230/240 V AC<br>conventional compensated                                 | 25.000 switching cycles  |
| Switching frequency                                | mechanical operations  | $10 \times 10^6$         |
|  | switching frequency  | 10 Hz                    |
|  | resistive load / lamp load   | 2 Hz                     |
|  | inductive load   | 0.5 Hz                   |
| <b>UL/CSA</b>                                      |  |                          |
| Continuous current at 240 V                        | 10 A AC  |                          |
| Continuous current at 24 V                         | 8 A DC   |                          |
| AC   | Utilization category (Control Circuit Rating Codes)                                  | B 300 Light Pilot Duty   |
|  | max. rated operational voltage   | 300 V AC                 |
|  | max. continuous thermal current $\cos \varphi = 1$ at B 300                          | 5 A                      |
|  | max. making / breaking apparent power<br>(Make/Break) $\cos \varphi \neq 1$ at B 300 | 3600/360 VA              |
| DC   | Utilization category (Control Circuit Rating Codes)                                  | R 300 Light Pilot Duty   |
|  | max. rated operational voltage   | 300 V DC                 |
|  | max. continuous thermal current at R 300   | 1 A                      |
|  | max. making / breaking apparent power<br>(Make/Break) at R 300                       | 28/28 VA                 |

Data at  $T_a = 25\text{ °C}$  and rated values, if nothing else indicated.

| Type  | CL-LDT...  |
|---|--|
| <b>Output circuit - Transistor outputs</b>  |  |
| Number  | 4  |
| Rated operational voltage $U_o$   | 24 V DC  |
| Operational voltage range   | 20.4-28.8 V DC   |
| Residual ripple   | -  |
| Supply current  | on „0“ signal<br>typ. 18 mA / max. 32 mA<br>on „1“ signal<br>typ. 24 mA / max. 44 mA   |
| Reverse voltage protection  | yes (Attention: If supply voltage is reversed, applying voltage at the outputs, causes a short circuit.)   |
| Electrical isolation  | from voltage supply<br>yes<br>from the inputs<br>yes<br>from PC interface, memory module,<br>CL-NET, CL-LINK<br>yes  |
| Rated operational current $I_o$ on „1“ signal DC  | max. 0.5 A   |
| Lamp load without $R_L$   | 5 W (Q1-Q4)  |
| Residual current on „0“ signal per channel  | < 0.1 mA   |
| Max. output voltage   | on „0“ signal at external load < 10 M $\Omega$<br>2.5 V<br>on „1“ signal at $I_o = 0.5$ A<br>$U = U_o - 1$ V   |
| Short-circuit protection  | thermal (Q1-Q4), (analysis results from diagnosis input I16)   |
| Short-circuit tripping current for $R_L \leq 10$ m $\Omega$   | $0.7$ A $\leq I_o \leq 2$ A per output   |
| Total short-circuit current   | 8 A  |
| Peak short-circuit current  | 16 A   |
| Thermal tripping  | yes  |
| Max. switching frequency with constant resistive load $R_L < 100$ k $\Omega$<br>(depending on active channels and their load) | 40.000 switching cycles/h  |
| Parallel connection of outputs  | with resistive load, inductive load with external<br>suppressor, combination within one group<br>group 1: Q1-Q4<br>number of outputs<br>max. 4<br>max. total current<br>2 A (Attention! Outputs must be actuated simultaneously<br>and for the same length of time.) |
| Indication of operational states of the outputs   | LCD-Display (if existing)  |
| Inductive load <sup>1)</sup> without external suppressor  |  |
| $T_{0.95} = 1$ ms,<br>$R = 48$ $\Omega$ ,<br>$L = 16$ mH  | utilization factor<br>0.25 g<br>duty time<br>100 %<br>max. switching frequency $f = 0.5$ Hz<br>(max. duty time = 50 %)<br>1500 switching cycles  |
| DC13,<br>$T_{0.95} = 72$ ms,<br>$R = 48$ $\Omega$ ,<br>$L = 1.15$ H   | utilization factor<br>0.25 g<br>duty time<br>100 %<br>max. switching frequency $f = 0.5$ Hz<br>(max. duty time = 50 %)<br>1500 switching cycles  |
| $T_{0.95} = 15$ ms,<br>$R = 48$ $\Omega$ ,<br>$L = 0.24$ H  | utilization factor<br>0.25 g<br>duty time<br>100 %<br>max. switching frequency $f = 0.5$ Hz<br>(max. duty time = 50 %)<br>1500 switching cycles  |
| Inductive load <sup>1)</sup> with external suppressor   |  |
|   | demand factor<br>1 g<br>duty time<br>100 %<br>max. switching frequency<br>max. duty time<br>depends on suppressor  |

<sup>1)</sup> For inductive loading, without external suppression of the transistor outputs, the following applies:  
 $T_{0.95}$  = time in ms, until 95 % of the steady-state current is achieved.  $T_{0.95} \cdot 3 \times T_{0.65} = 3 \times L/R$ .

Data transfer rate in the CL-NET network: bus lengths of 40 m and over only attainable with cables with additional cross-section and connection adapter.

# Logic relays

## Approximate dimensions

CL Range  
Logic relays

CL-LSR, CL-LST

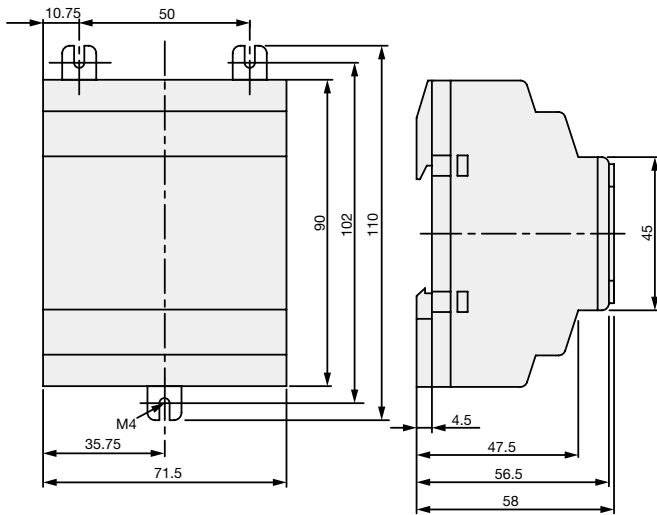

CL-LMR, CL-LMT

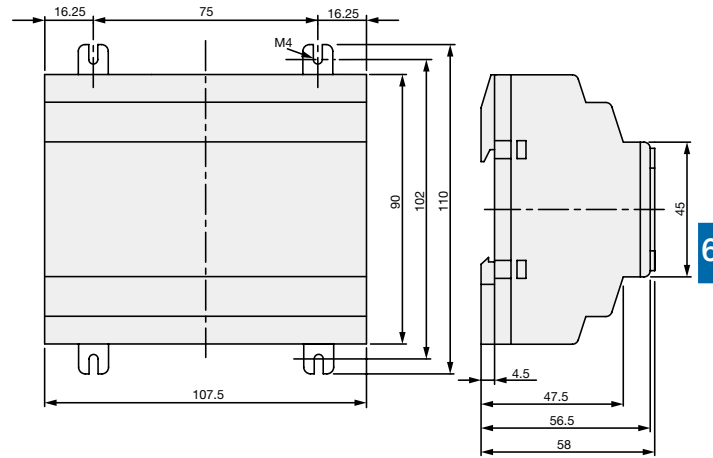

6

CL-LDD

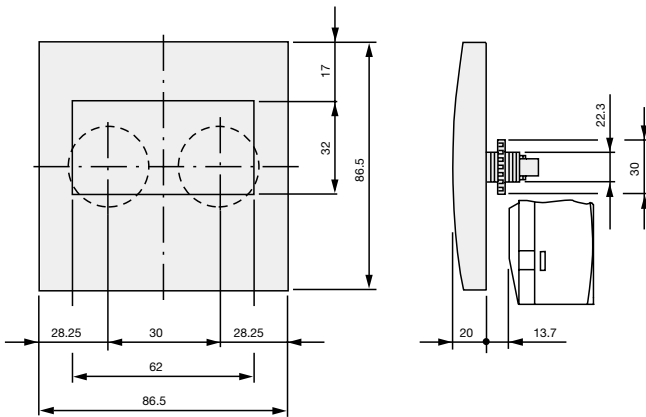

CL-LDD.K + CL-LDC.L. +  
(CL-LDR or CL-LDT)

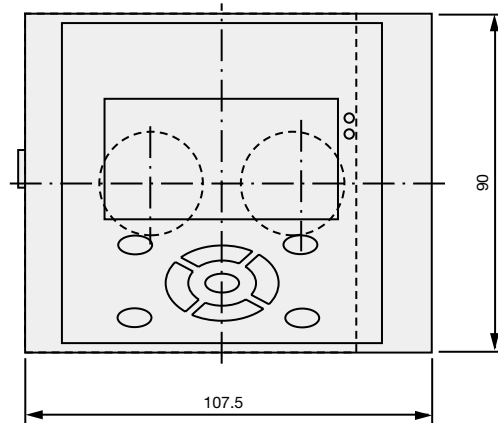

CL-LDR, CL-LDT

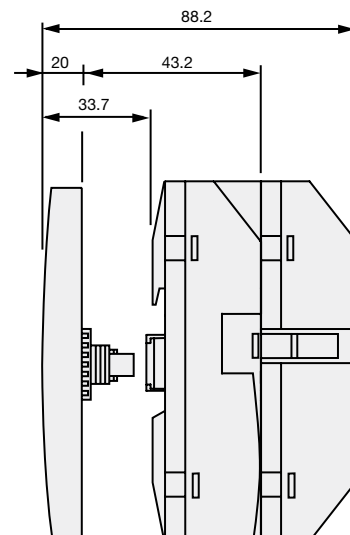
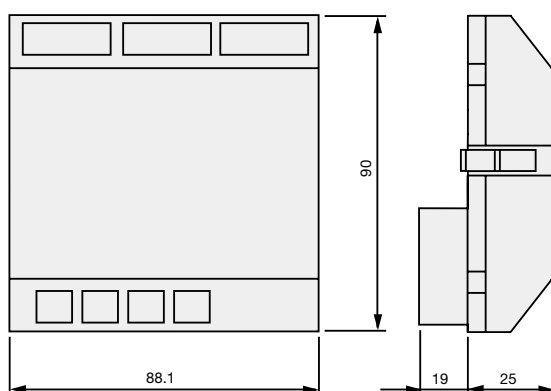

6

CL-LER.20

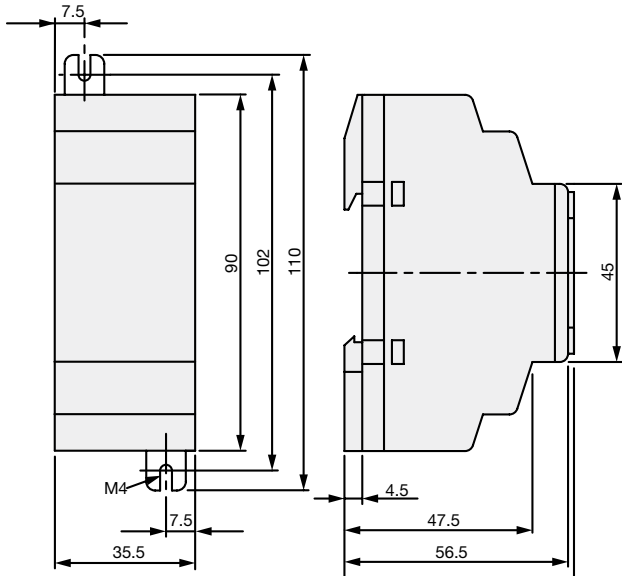

CL-LDC.S..

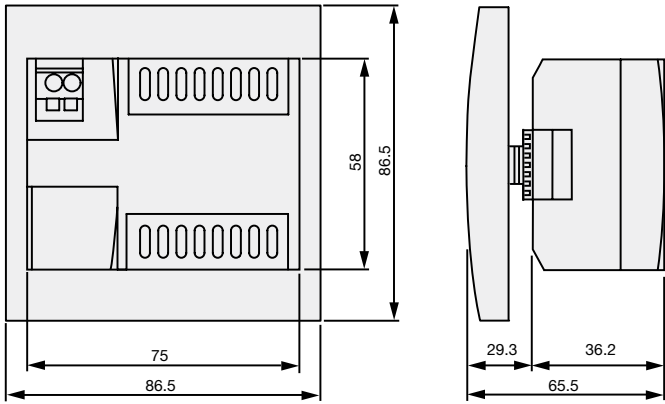

## X-ON Electronics

Largest Supplier of Electrical and Electronic Components

*Click to view similar products for [General Purpose Relays](#) category:*

*Click to view products by [ABB](#) manufacturer:*

Other Similar products are found below :

[APF30318](#) [JVN1AF-4.5V-F](#) [PCN-105D3MHZ](#) [5JO-10000S-SIL](#) [5JO-1000CD-SIL](#) [5JO-400CD-SIL](#) [LY2S-AC220/240](#) [LYQ20DC12](#)  
[6031007G](#) [6131406HQ](#) [6-1393099-8](#) [6-1393122-4](#) [6-1393123-2](#) [6-1393767-1](#) [6-1393843-7](#) [6-1415012-1](#) [6-1419102-2](#) [6-1423698-4](#) [6-](#)  
[1608051-6](#) [6-1608067-0](#) [6-1616170-6](#) [6-1616248-2](#) [6-1616282-3](#) [6-1616348-2](#) [6-1616350-1](#) [6-1616350-8](#) [6-1616358-7](#) [6-1616359-9](#) [6-](#)  
[1616360-9](#) [6-1616931-6](#) [6-1617039-1](#) [6-1617052-1](#) [6-1617090-2](#) [6-1617090-5](#) [6-1617347-5](#) [6-1617353-3](#) [6-1617801-8](#) [6-1618107-9](#) [6-](#)  
[1618248-4](#) [M83536/1-027M](#) [CX-4014](#) [MAHC-5494](#) [MAVCD-5419-6](#) [703XCX-120A](#) [7-1393100-5](#) [7-1393111-7](#) [7-1393767-8](#) [7-1414968-8](#)  
[7-1419130-3](#) [7-1608047-2](#)