



SMD 3020 LED SERIES

OF-SMD3020Y YELLOW



ATTENTION
OBSERVE PRECAUTIONS
FOR HANDLING
ELECTROSTATIC
DISCHARGE
SENSITIVE
DEVICES



Description

The Yellow source color devices are made with Gallium Yellow Light Emitting Diode.

Features

- PLCC-2 Package
- White SMT package
- Suitable for all SMT assembly and solder process.
- Available on tape and reel
- Package:3000pcs/reel.

Applications

- Optical indicator
- Coupling into light
- LCD
- Cellular phones

Package Dimensions

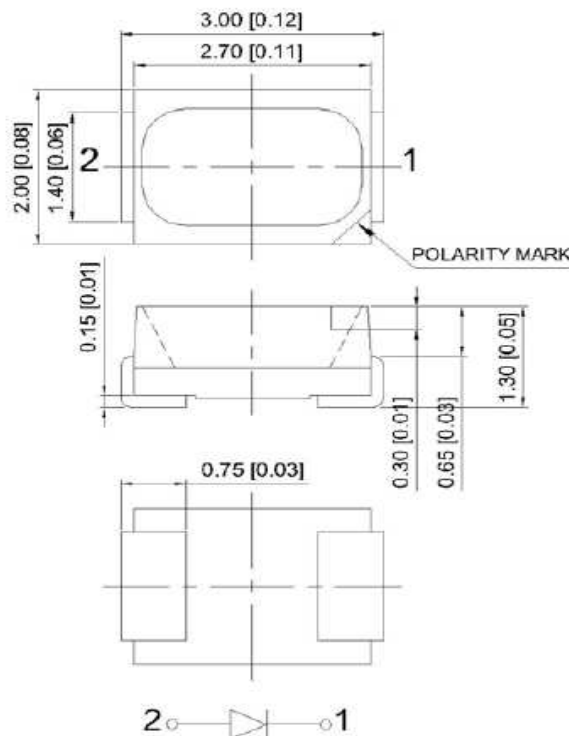

Notes:



SMD 3020 LED SERIES

1. All dimension units are millimeters.
2. All dimension tolerance is $\pm 0.2\text{mm}$ unless otherwise noted.
3. An epoxy meniscus may extend about 1.5mm down the leads.
4. Burr around bottom of epoxy may be 0.5mm max..

Selection Guide

Part. No	Dice	Lens Type	Iv(mcd) @20mA		Viewing Angle 2 θ 1/2
			Min.	Typ.	
OF-SMD3020Y	YELLOW (InGaAlP)	Water Clear	210	280	120°

Note:

1. θ 1/2 is the angle from optical centerline where the luminous intensity is 1/2 the optical centerline value.

Electrical / Optical Characteristics at TA=25°C

Parameter	Symbol	Device	Condition	Min	Typ	Unit
Forward Voltage DC	VF	Yellow	IF=20mA	1.8	2.0	V
Reverse Current	IR	Yellow	VR=5V		5	μA
Dominant Wavelength	λ_D	Yellow	IF=20mA	585	590	nm
Capacitance	IF(rec)	Yellow	VF=0V; f=1MHz		20	pF

Absolute Maximum Ratings at TA=25°C

Parameter	Yellow	Units
Power Dissipation	75	mW
DC Forward Current	30	mA
Peak Forward Current	140	mA
Reverse Voltage	5	V
Operating/Storage Temperature	-40°C to +85°C	

Note:

1. 1/10 Duty Cycle, 0.1ms Pulse Width.

Reliability Test Items And Conditions

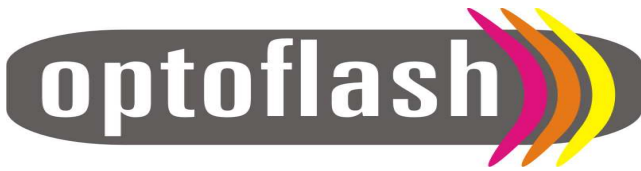

SMD 3020 LED SERIES

The reliability of products shall be satisfied with items listed below.
Confidence level :90% LTPD :10%

No.	Items	Test Condition	Test Hours/Cycles	Sample Size	Ac/Rc
1	Reflow	Temp:240°C±5°C Min.5 sec.	6 Min.	22Pcs.	0/1
2	Temperature Cycle	H:+100°C 15 min. ~ 5 min L:-40°C 15 min.	300 Cycles	22Pcs.	0/1
3	Thermal Shock	H:+100°C 5 min. ~ 10 sec. L:-10°C 5 min.	300 Cycles	22Pcs.	0/1
4	High Temperature Storage	Temp.:100°C	1000Hrs.	22Pcs.	0/1
5	Low Temperature Storage	Temp.: -55°C	1000Hrs.	22Pcs.	0/1
6	DC Operating Life	I _F =20mA	1000Hrs.	22Pcs.	0/1
7	High Temperature/High Humidity	85°C/R.H85%	1000Hrs.	22Pcs.	0/1

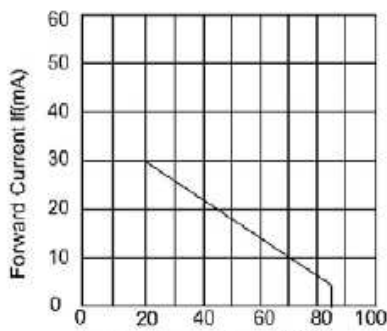

Ambient Temperature TA(°C)
Forward current
Derating Curve

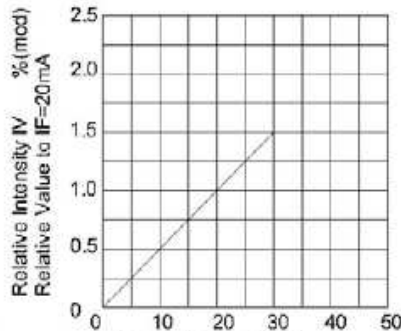

IF-Forward Current (mA)
Luminous Intensity vs.
Forward Current

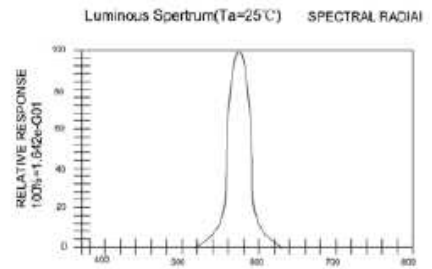

Luminous Spetrum(Ta=25°C) SPECTRAL RADI

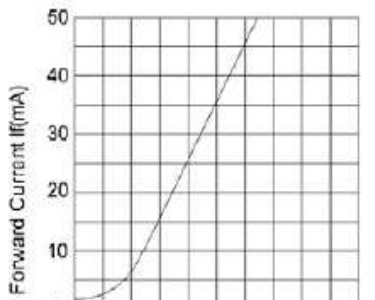

Forward Current VS.
Forward Voltage

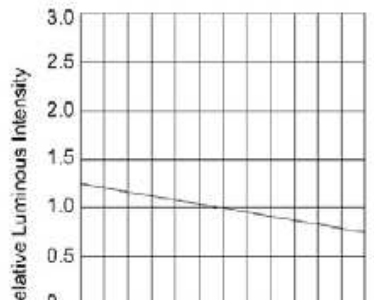

Ambient Temperature Ta(°C)
Luminous Intensity
Ambient Temperature

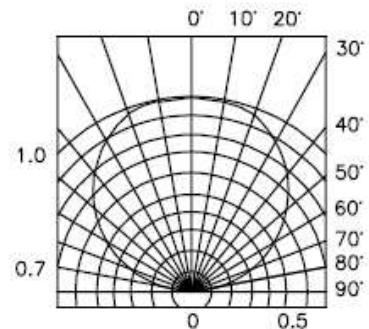

SPATIAL DISTRIBUTION

SMT Reflow Soldering Instructions

Number of reflow process shall be less than 2 times and cooling process to normal temperature is required between first and second soldering process.

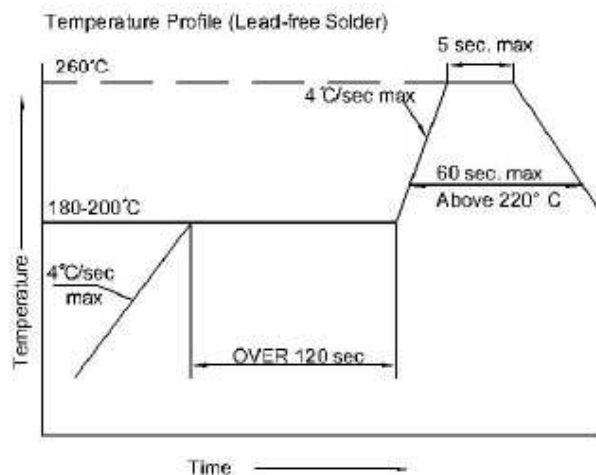
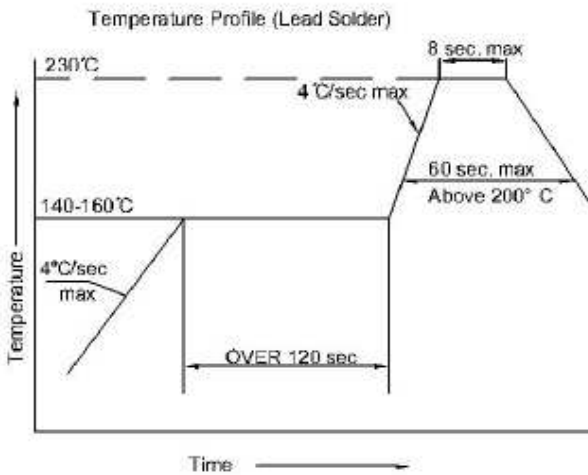

Recommended Soldering Pattern (Units : mm)

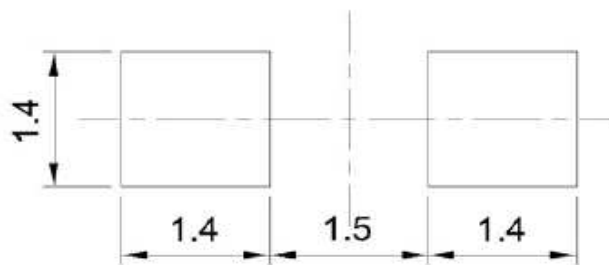

Tape Specifications (Units : mm)

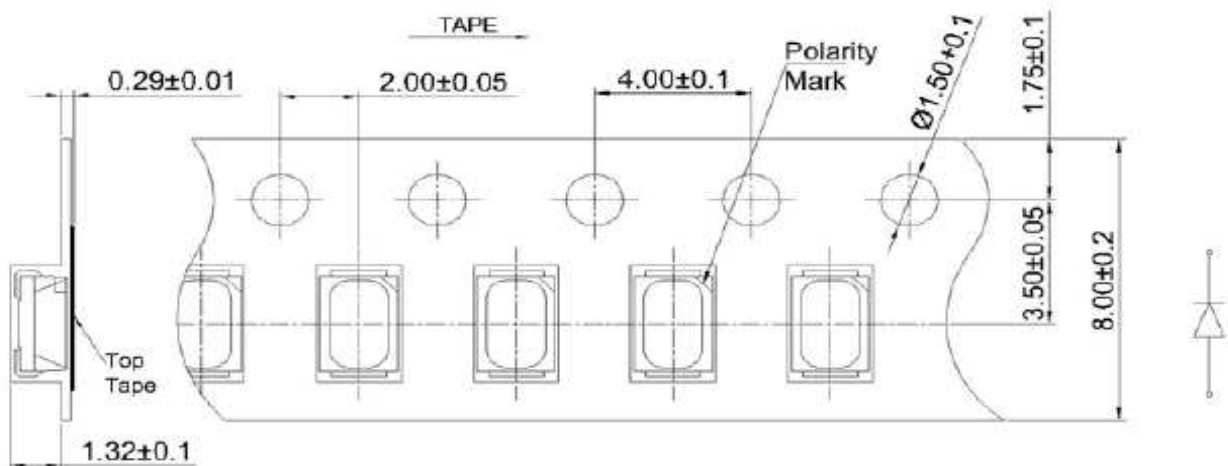

X-ON Electronics

Largest Supplier of Electrical and Electronic Components

Click to view similar products for [Standard LEDs - SMD category](#):

Click to view products by [Optoflash manufacturer](#):

Other Similar products are found below :

[LTST-C19GD2WT](#) [LTST-N683GBEW](#) [597-3006-607F](#) [597-3403-607F](#) [LTW-K140SZR40](#) [LTW-M140ZVS](#) [598-8110-100F](#) [598-8170-100F](#)
[598-8610-202F](#) [7012X7](#) [AAAF5060QBFSEEZGS](#) [12-22SURSYGC/S530-A3/E2/TR8](#) [1383SURT/S530-A3/TR1\(R\)](#) [APT1608QGW](#)
[EASV1803BA0](#) [HT-F104TW-5860](#) [SML310BATT86](#) [SML-512VWT86A](#) [SML-LX0606SISUGC/A](#) [SML-LXL1307SRC-TR](#) [SML-](#)
[LXR851SIUPGUBC](#) [LT1ED53A](#) [17-21/G6C-FM1N2B/3T](#) [FAT801-S](#) [SSL-LXA227IC-TR31A](#) [AM27ZGC03](#) [APB3025SGNC](#)
[APHK1608VGCA](#) [APT2012QGW](#) [CLMVC-FKA-CA1E1L81BB7C3C3](#) [CLYBA-FKA-CFHHL9BBB7A363](#) [CMD11504UR](#) [LTW-](#)
[020ZDCG](#) [LTW-21TS5](#) [LTW-K140SZR30](#) [HSMY-C177](#) [HT-121UYG-4739](#) [UYGT801-S](#) [KVH1C100MF6R](#) [42-21SYGC/S530-E1/TR8](#)
[YGFR411-H](#) [597-2311-402F](#) [5973212407NF](#) [597-3302-607F](#) [597-5202-407F](#) [598-8330-117F](#) [SAW8WA2A-L35M40-CA](#) [SML013WBDW1](#)
[SML522BUWT86](#) [SML-LX0402IC-TR](#)