

RoHS

Specification

Customer Name : _____

Customer P/N : _____ OF-SMD3216G

Factory P/N : _____

Sending Date : _____

Features

- Extremely wide viewing angle.
- Suitable for all SMT assembly and solder process.
- Available on tape and reel.
- Moisture sensitivity level: Level 4.
- Package:3000pcs/reel..
- RoHS compliant.

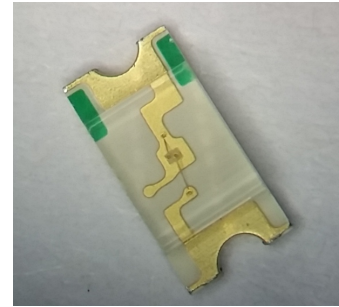

Description

The Green source color devices are made with InGaN on Substrate Light Emitting Diode



ATTENTION
OBSERVE PRECAUTIONS
FOR HANDLING
ELECTROSTATIC
DISCHARGE
SENSITIVE
DEVICES

Applications

- Optical indicator
- Indoor display
- Backlight for LCD, switch and Symbol, display
- General use

Package Dimensions

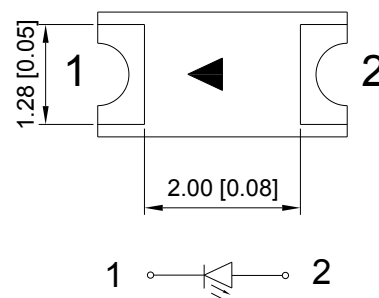
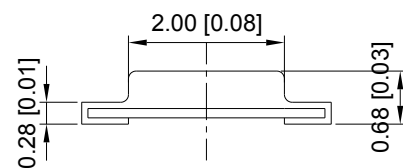
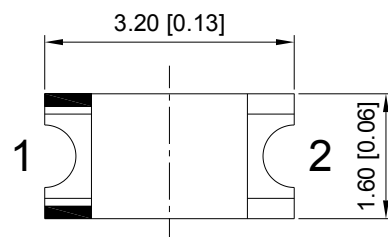

Recommended Soldering Pattern

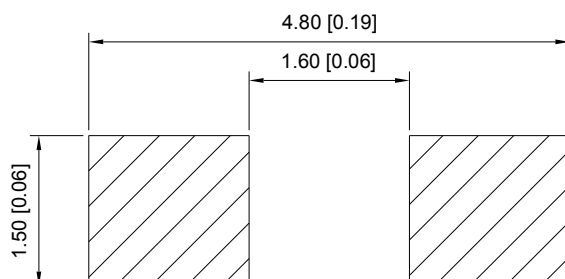

Notes:

1. Mark the size of the unit is mm.marked in brackets
2. All dimensions allow tolerance + 0.1mm

Selection Guide

Part No.	Dice	Lens Type	Luminous intensity(mcd) @ 20mA		Viewing Angle
			Min	Typ	2θ1/2
OF-SMD3216G	Green (InGaN)	Water Clear	600	800	140°

Note:

1. The 2θ1/2 measurement error ±10 degrees
2. the above luminous intensity measurement allowance tolerance ±10%.

Electrical / Optical Characteristics at Ta=25°C 电性与光学特性

Parameter	Symbol	Min.	Typ.	Max.	Units	Test Conditions
Forward Voltage	V _F	2.8	--	3.4	V	I _F =20mA
Reverse Current	I _R	--	--	10	μA	V _R = 5V
Dominate Wavelength	λ _d	515	--	525	nm	I _F =20mA

Absolute Maximum Ratings at Ta=25°C

Parameter	Symbol	Rating	Units
Power Dissipation	P _d	105	mW
Forward Current	I _F	30	mA
Peak Forward Current [1]	I _{FP}	100	mA
Reverse Voltage	V _R	5	V
Electrostatic Discharge (HBM)	ESD	1000	V
Operating Temperature	Topr	-40 ~ +85	°C
Storage Temperature	Tstg	-40 ~ +100	°C

Note:

1. 1/10 Duty cycle, 0.1ms pulse width.
2. The above forward voltage measurement allowance tolerance is ±0.1V.

Typical optical characteristics curves

Ambient Temperature vs. Forward Current

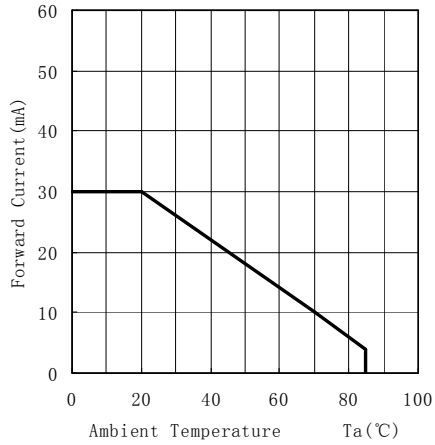

Forward Current VS. Relative Intensity

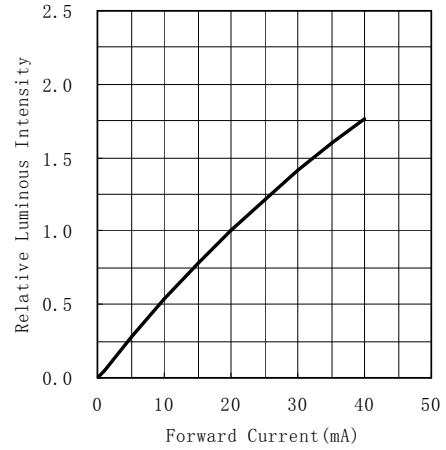

Forward Voltage VS. Forward Current

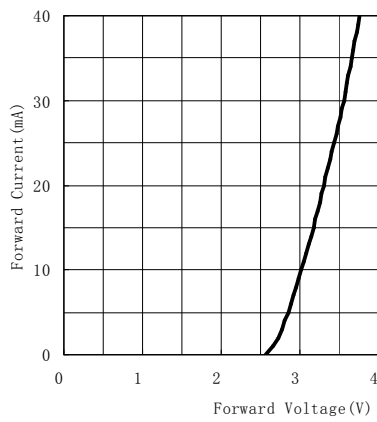

Ambient Temperature VS. Relative Intensity

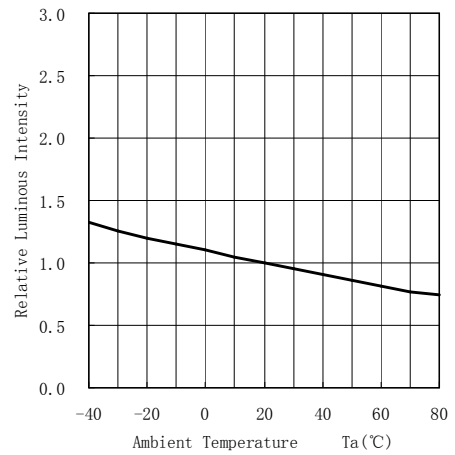

Relative spectral emission

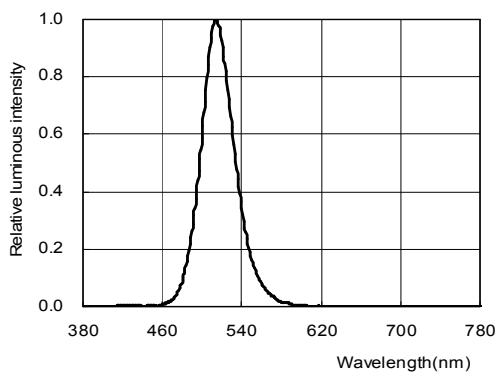

Radiation diagram

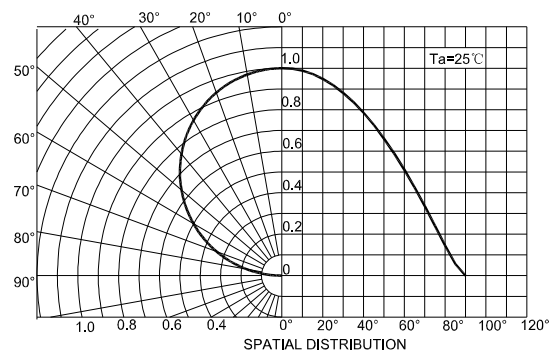

Reliability Test Items And Conditions

Test Items	Ref.Standard	Test Condition	Time	Quantity	Ac/Re
Reflow	JESD22-B106	Temp:260°Cmax T=10 sec	3 times.	22Pcs.	0/1
Temperature Cycle	JESD22-A104	100°C±5°C 30 min. ↑↓5 min -40°C±5°C 30 min.	100 Cycles	22Pcs.	0/1
High Temperature Storage	JESD22-A103	Temp:100°C±5°C	1000Hrs.	22Pcs.	0/1
Low Temperature Storage	JESD22-A119	Temp:-40°C±5°C	1000Hrs.	22Pcs.	0/1
Life Test	JESD22-A108	Ta=25°C±5°C IF=20mA	1000Hrs.	22Pcs.	0/1
High Temperature High Humidity	JESD22-A101	85°C±5°C/ 85%RH	1000Hrs.	22Pcs.	0/1

Criteria For Judging Damage

Test Items	Symbol	Test Condition	Criteria For Judgement	
			Min.	Max.
Forward Voltage	VF	IF=20mA	--	U.S.L*)x1.1
Reverse Current	IR	VR = 5V	--	U.S.L*)x2.0
Luminous Flux	Im	IF=20mA	L.S.L*)x0.7	--

U.S.L: Upper standard level

L.S.L: Lower standard level

*The technical information shown in the data sheets are limited to the typical characteristics and circuit examples of the referenced products. It does not constitute the warranting of industrial property nor the granting of any license.

SMT Reflow Soldering Instructions

1. Reflow soldering should not be done more than two times.
2. When soldering, do not put stress on the LEDs during heating

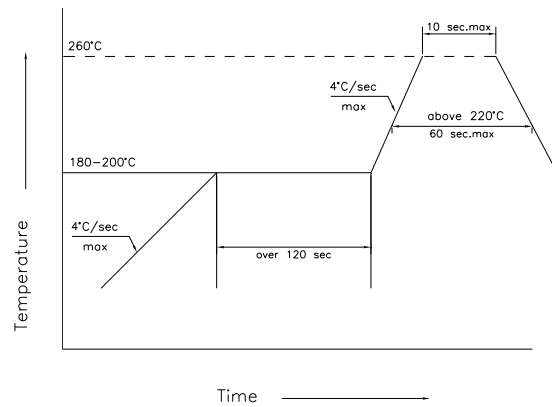

Soldering iron

1. When hand soldering, keep the temperature of iron below less 300°C less than 3 seconds
2. The hand solder should be done only one times

Repairing

Repair should not be done after the LEDs have been soldered. When repairing is unavoidable, a double-head soldering iron should be used (as below figure). It should be confirmed in advance whether the characteristics of LEDs will or will not be damaged by repairing.

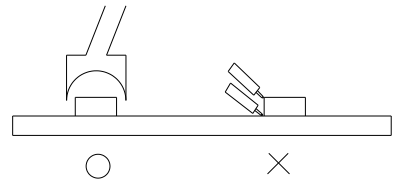

Cautions

The encapsulated material of the LEDs is silicone. Therefore the LEDs have a soft surface on the top of package. The pressure to the top surface will be influence to the reliability of the LEDs. Precautions should be taken to avoid the strong pressure on the encapsulated part. So when use the picking up nozzle, the pressure on the silicone resin should be proper.

3. Do not stack together assembled PCBs containing LEDs. Impact may scratch the silicone lens or damage the internal circuitry

4. Not suitable to operate in acidic environment, PH<7

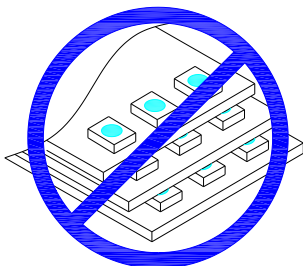

Label

IV: Luminous intensity rank
 WD: Dominate Wavelength
 VF: Forward voltage rank

RoHS

Part No: XXXXXXXXXXXXXXXXXXXX
 IV: VF: WD:
 Quantity:
 Sealing date: XXXXXXXXXXXXXXXXXXXX



Tape Specifications (Units : mm)

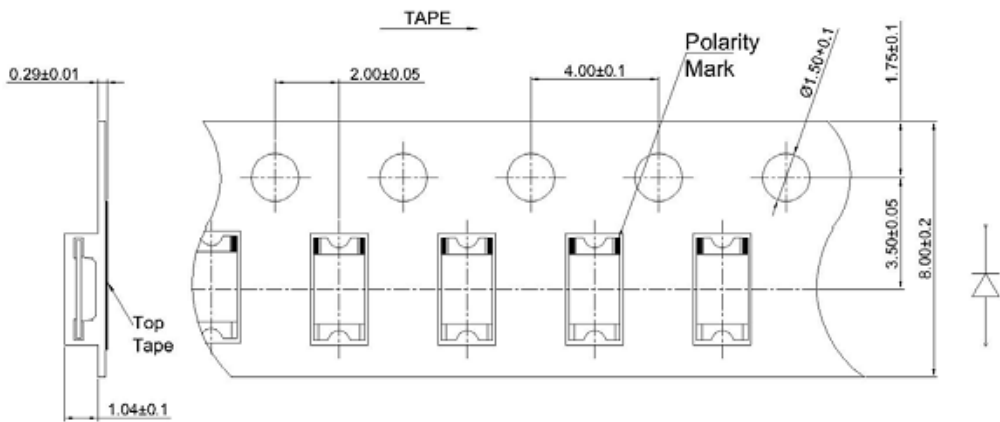

Reel Dimensions

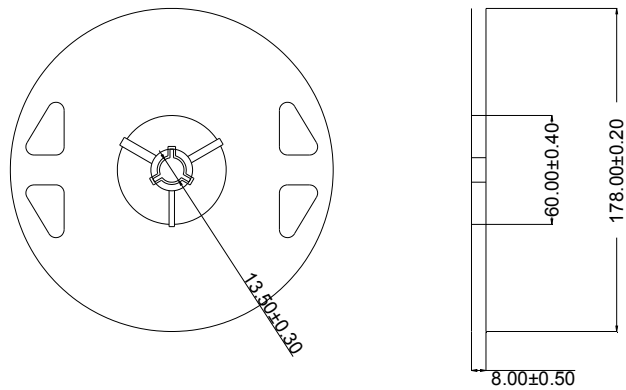

Moisture Resistant Packaging

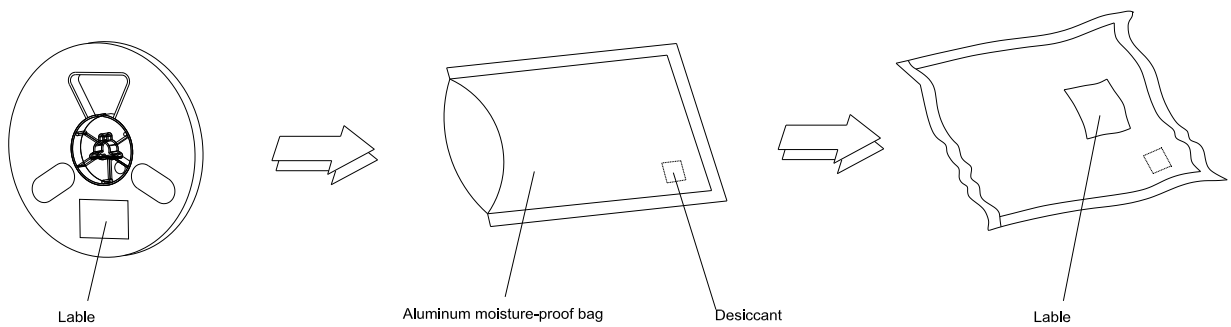

Note: The tolerances unless mentioned is ±0.1mm , Unit: mm

X-ON Electronics

Largest Supplier of Electrical and Electronic Components

Click to view similar products for [Standard LEDs - SMD category](#):

Click to view products by [Optoflash manufacturer](#):

Other Similar products are found below :

[LTST-C19GD2WT](#) [LTST-N683GBEW](#) [597-3006-607F](#) [597-3403-607F](#) [LTW-K140SZR40](#) [LTW-M140ZVS](#) [598-8110-100F](#) [598-8170-100F](#)
[598-8610-202F](#) [7012X7](#) [AAAF5060QBFSEEZGS](#) [12-22SURSYGC/S530-A3/E2/TR8](#) [1383SURT/S530-A3/TR1\(R\)](#) [APT1608QGW](#)
[EASV1803BA0](#) [HT-F104TW-5860](#) [SML310BATT86](#) [SML-512VWT86A](#) [SML-LX0606SISUGC/A](#) [SML-LXL1307SRC-TR](#) [SML-](#)
[LXR851SIUPGUBC](#) [LT1ED53A](#) [17-21/G6C-FM1N2B/3T](#) [FAT801-S](#) [SSL-LXA227IC-TR31A](#) [AM27ZGC03](#) [APB3025SGNC](#)
[APHK1608VGCA](#) [APT2012QGW](#) [CLMVC-FKA-CA1E1L81BB7C3C3](#) [CLYBA-FKA-CFHHL9BBB7A363](#) [CMD11504UR](#) [LTW-](#)
[020ZDCG](#) [LTW-21TS5](#) [LTW-K140SZR30](#) [HSMY-C177](#) [HT-121UYG-4739](#) [UYGT801-S](#) [KVH1C100MF6R](#) [42-21SYGC/S530-E1/TR8](#)
[YGFR411-H](#) [597-2311-402F](#) [5973212407NF](#) [597-3302-607F](#) [597-5202-407F](#) [598-8330-117F](#) [SAW8WA2A-L35M40-CA](#) [SML013WBDW1](#)
[SML522BUWT86](#) [SML-LX0402IC-TR](#)