

RoHS

Specification

Client Name: _____

Client P/N: _____

Factory P/N: OF-SMD3216PG

Sending Date: _____

Features

- Extremely wide viewing angle
- Suitable for all SMT assembly and solder process
- Available on tape and reel
- Moisture sensitivity level: Level 4
- Package:3000pcs/reel
- RoHS compliant



Description

The Green source color devices are made with InGaN on Substrate Light Emitting Diode

Applications

- Optical indicator
- Indoor display
- Backlighting in dashboard and switch
- Flat backlighting for LCD, symbol and display
- General use



ATTENTION
OBSERVE PRECAUTIONS
FOR HANDLING
ELECTROSTATIC
DISCHARGE
SENSITIVE
DEVICES

Package Dimensions

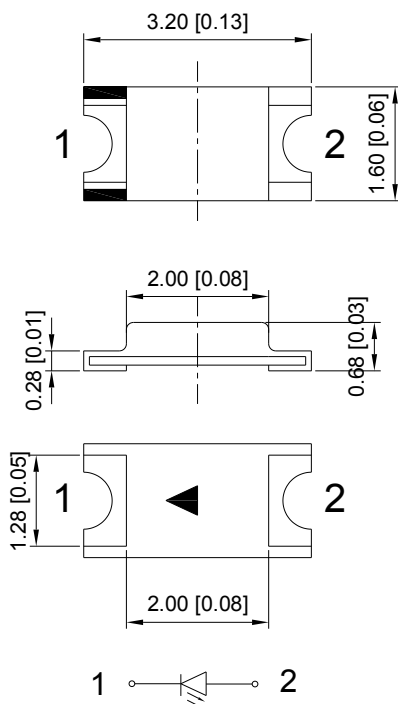

Recommended Soldering Pattern

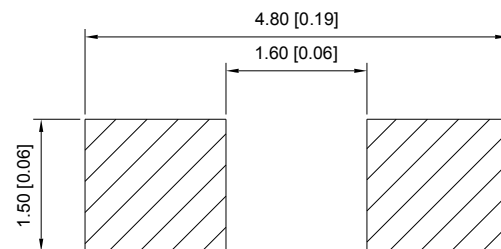

Notes:

1. All dimension units are millimeters.
2. All dimension tolerance is ± 0.15 mm unless otherwise noted.

Selection Guide

Part No.	Dice	Lens Type	Luminous intensity(mcd) @ 20mA		Viewing Angle
			Min.	Max.	2θ1/2
OF-SMD3216PG	Green (InGaN)	Water Clear	600	780	120°
			780	1000	
			1000	1300	

Note:

1. θ1/2 is the angle from optical centerline where the luminous intensity is 1/2 the optical centerline value.
2. the above luminous intensity measurement allowance tolerance ±10%.

Electrical / Optical Characteristics at Ta=25°C

Parameter	Symbol	Min.	Typ.	Max	Units	Test Conditions
Forward Voltage	V _F	2.8	--	3.4	V	I _F =20mA
Reverse Current	I _R	--	--	10	μA	V _R = 5V
Dominate Wavelength	λ _d	514	--	524	nm	I _F =20mA

Absolute Maximum Ratings at Ta=25°C

Parameter	Symbol	Value	Units
Power dissipation	P _d	105	mW
DC Forward Current	I _F	30	mA
Peak Forward Current [1]	I _{FP}	100	mA
Reverse Voltage	V _R	5	V
Electrostatic Discharge (HBM)	ESD	1000	V
Operating Temperature	T _{opr}	-40 ~ +85	°C
Storage Temperature	T _{stg}	-40 ~ +100	°C

Note:

1. 1/10 Duty Cycle, 0.1ms Pulse Width.

Typical optical characteristics curves

Ambient Temperature VS. Forward Current

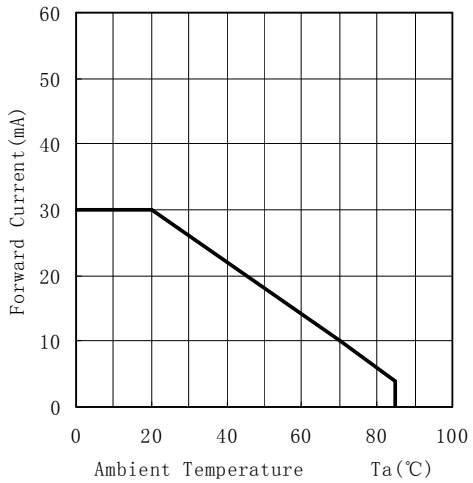

Forward Current VS. Relative Intensity

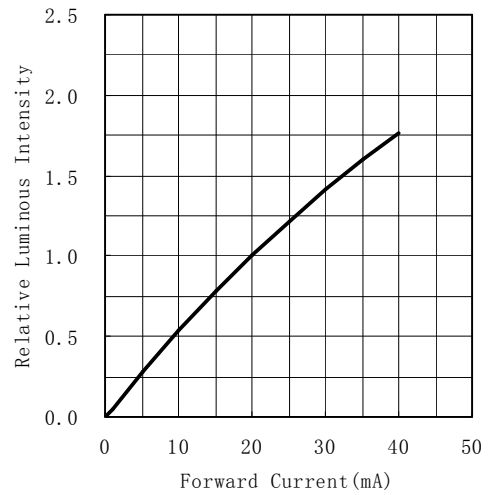

Forward Voltage VS. Forward Current

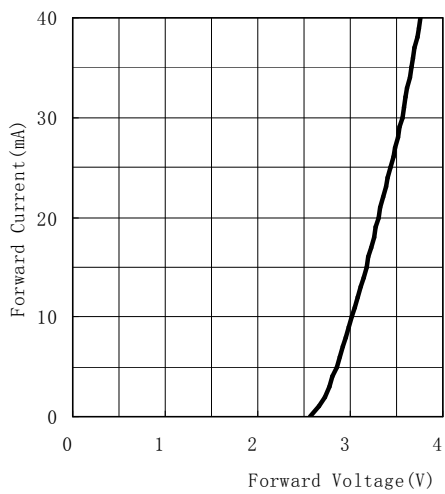

Ambient Temperature VS. Relative Intensity

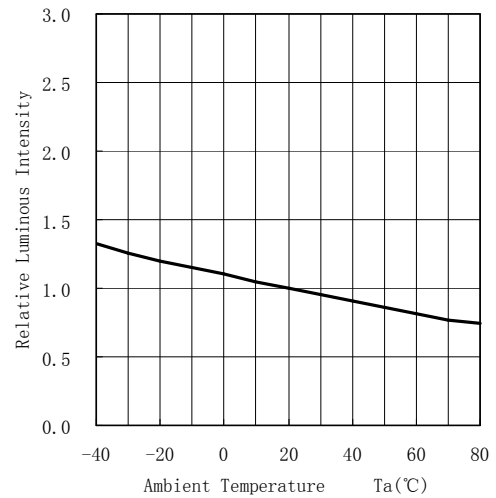

Relative spectral emission

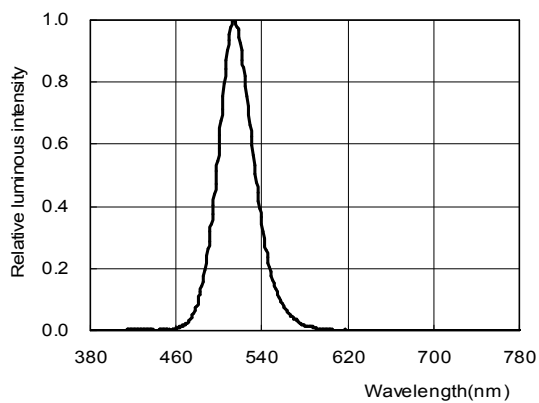
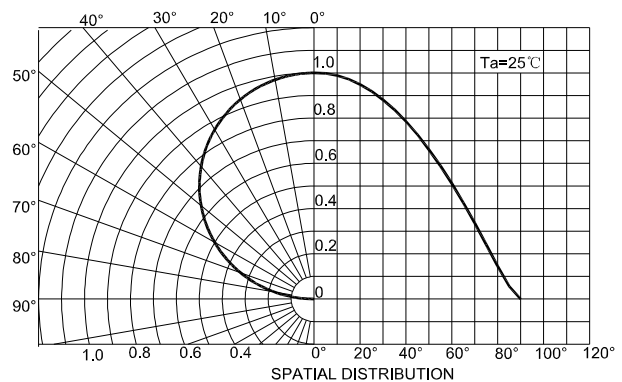

Diagram characteristics of radiation



Reliability Test Items And Conditions

The reliability of products shall be satisfied with items listed below.
 Confidence level :90%
 LTPD :10%

No.	Items	Ref. Standard	Test Condition	Test Hours/ Cycles	Sample Size	Ac/Re
1	Reflow	JESD22-B106	Temp:260°Cmax T=10 sec	3 times.	22Pcs.	0/1
2	Temperature Cycle	JESD22-A104	100°C±5°C 30 min. ↑↓5 min -40°C±5°C 30 min.	100 Cycles	22Pcs.	0/1
3	Thermal Shock	JESD22-A106	100°C±5°C 5 min. ↑↓ -40°C±5°C 5 min.	100 Cycles	22Pcs.	0/1
4	High Temperature Storage	JESD22-A103	Temp:100°C±5°C	1000Hrs.	22Pcs.	0/1
5	Low Temperature Storage	JESD22-A119	Temp:-40°C±5°C	1000Hrs.	22Pcs.	0/1
6	DC Operating Life	JESD22-A108	Ta=25°C±5°C IF=20mA	1000Hrs.	22Pcs.	0/1
7	High Temperature High Humidity	JESD22-A101	85°C±5°C/ 85%RH IF=5mA	1000Hrs.	22Pcs.	0/1

*The technical information shown in the data sheets are limited to the typical characteristics and circuit examples of the referenced products. It does not constitute the warranting of industrial property nor the granting of any license.

SMT Reflow Soldering Instructions

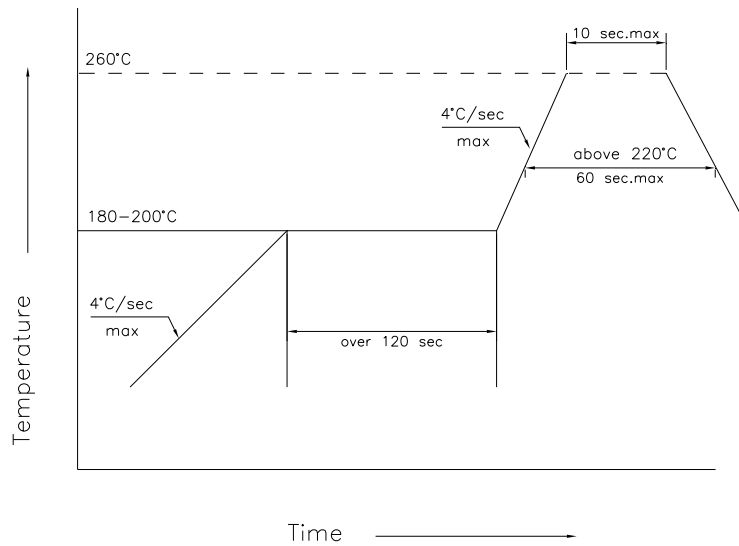

- 1.Reflow soldering should not be done more than two times
- 2.When soldering , do not put stress on the LEDs during heating

Soldering iron

- 1.When hand soldering, the temperature of the iron must less than 300°C for 3 seconds
- 2.The hand solder should be done only one times

Repairing

Repair should not be done after the LEDs have been soldered. When repairing is unavoidable, a double-head soldering iron should be used (as below figure). It should be confirmed beforehand whether the characteristics of LEDs will or will not be damaged by repairing.

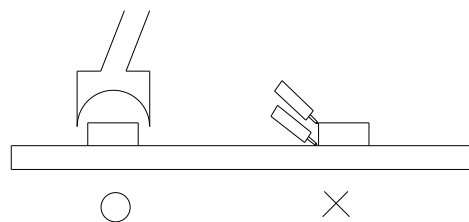

Label

IV: Luminous intensity rank
 λD: Dominate Wavelength
 VF: Forward voltage rank

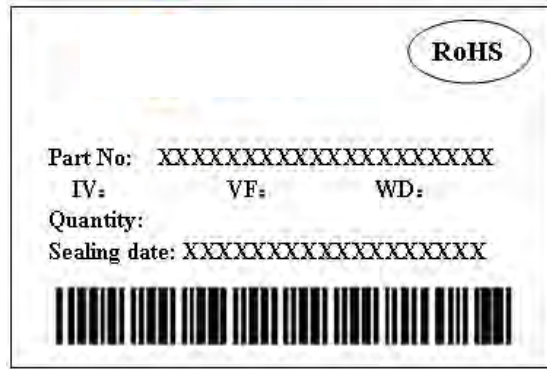

Tape Specifications (Units : mm)

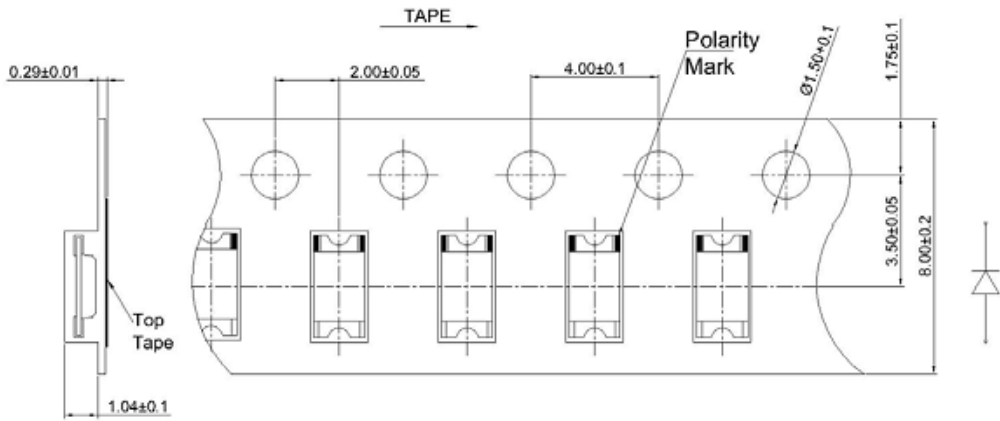

Reel Dimensions

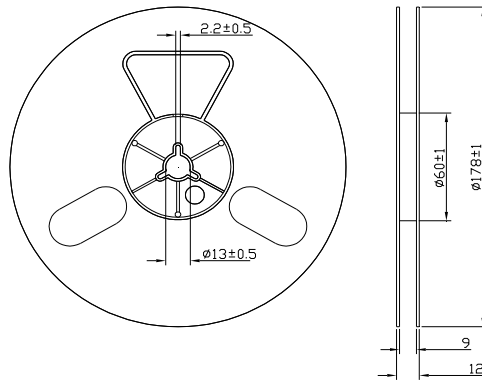

Moisture Resistant Packaging

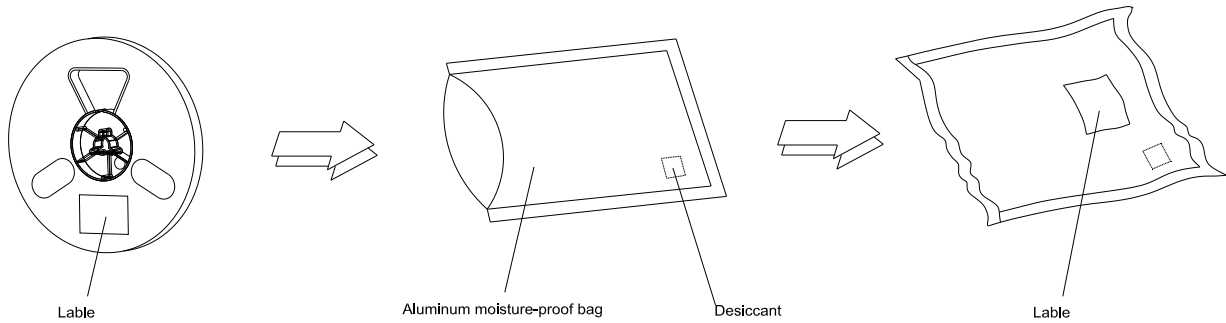

Note: The tolerances unless mentioned is ±0.1mm , Unit: mm

X-ON Electronics

Largest Supplier of Electrical and Electronic Components

Click to view similar products for [Standard LEDs - SMD category](#):

Click to view products by [Optoflash manufacturer](#):

Other Similar products are found below :

[LTST-C19GD2WT](#) [LTST-N683GBEW](#) [597-3006-607F](#) [597-3403-607F](#) [LTW-K140SZR40](#) [LTW-M140ZVS](#) [598-8110-100F](#) [598-8170-100F](#)
[598-8610-202F](#) [7012X7](#) [AAAF5060QBFSEEZGS](#) [12-22SURSYGC/S530-A3/E2/TR8](#) [1383SURT/S530-A3/TR1\(R\)](#) [APT1608QGW](#)
[EASV1803BA0](#) [HT-F104TW-5860](#) [SML310BATT86](#) [SML-512VWT86A](#) [SML-LX0606SISUGC/A](#) [SML-LXL1307SRC-TR](#) [SML-](#)
[LXR851SIUPGUBC](#) [LT1ED53A](#) [17-21/G6C-FM1N2B/3T](#) [FAT801-S](#) [SSL-LXA227IC-TR31A](#) [AM27ZGC03](#) [APB3025SGNC](#)
[APHK1608VGCA](#) [APT2012QGW](#) [CLMVC-FKA-CA1E1L81BB7C3C3](#) [CLYBA-FKA-CFHHL9BBB7A363](#) [CMD11504UR](#) [LTW-](#)
[020ZDCG](#) [LTW-21TS5](#) [LTW-K140SZR30](#) [HSMY-C177](#) [HT-121UYG-4739](#) [UYGT801-S](#) [KVH1C100MF6R](#) [42-21SYGC/S530-E1/TR8](#)
[YGFR411-H](#) [597-2311-402F](#) [5973212407NF](#) [597-3302-607F](#) [597-5202-407F](#) [598-8330-117F](#) [SAW8WA2A-L35M40-CA](#) [SML013WBDW1](#)
[SML522BUWT86](#) [SML-LX0402IC-TR](#)