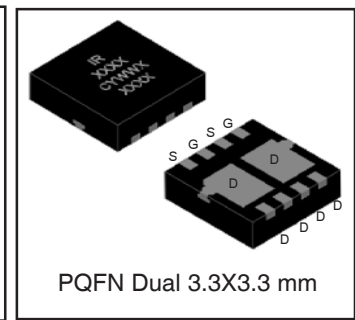
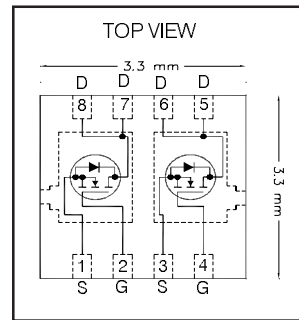


### HEXFET® Power MOSFET

$V_{DS}$	<b>30</b>	<b>V</b>
$V_{GS\ max}$	<b>± 20</b>	<b>V</b>
$R_{DS(on)\ max}$ (@ $V_{GS} = 10V$ )	<b>14.9</b>	<b>mΩ</b>
(@ $V_{GS} = 4.5V$ )	<b>20.4</b>	
$Q_g\ typ$	<b>6.7</b>	<b>nC</b>
$I_D$ (@ $T_{c(Bottom)} = 25^\circ C$ )	<b>10</b> ⑦	<b>A</b>



### Applications

- Power Stage for high frequency buck converters
- Battery Protection charge and discharge switches

### Features and Benefits

#### Features

Low Thermal Resistance to PCB (< 6.7°C/W)
Low Profile (<1.0mm)
Industry-Standard Pinout
Compatible with Existing Surface Mount Techniques
RoHS Compliant Containing no Lead, no Bromide and no Halogen
MSL1, Industrial Qualification

results in

⇒

#### Benefits

Enable better thermal dissipation
Increased Power Density
Multi-Vendor Compatibility
Easier Manufacturing
Environmentally Friendlier
Increased Reliability

Orderable part number	Package Type	Standard Pack		Note
		Form	Quantity	
IRFHM8363TRPBF	PQFN Dual 3.3mm x 3.3mm	Tape and Reel	4000	
IRFHM8363TR2PBF	PQFN Dual 3.3mm x 3.3mm	Tape and Reel	400	EOL notice #259

### Absolute Maximum Ratings

	Parameter	Max.	Units
$V_{DS}$	Drain-to-Source Voltage	30	V
$V_{GS}$	Gate-to-Source Voltage	± 20	
$I_D @ T_A = 25^\circ C$	Continuous Drain Current, $V_{GS} @ 10V$	11	A
$I_D @ T_A = 70^\circ C$	Continuous Drain Current, $V_{GS} @ 10V$	8.6	
$I_D @ T_{C(Bottom)} = 25^\circ C$	Continuous Drain Current, $V_{GS} @ 10V$	29⑥⑦	
$I_D @ T_{C(Bottom)} = 100^\circ C$	Continuous Drain Current, $V_{GS} @ 10V$	18⑥⑦	
$I_D @ T_C = 25^\circ C$	Continuous Drain Current, $V_{GS} @ 10V$ (Package Limited)	10⑦	
$I_{DM}$	Pulsed Drain Current ①	116	
$P_D @ T_A = 25^\circ C$	Power Dissipation ②	2.7	W
$P_D @ T_{C(Bottom)} = 25^\circ C$	Power Dissipation	19	
	Linear Derating Factor	0.02	W/°C
$T_J$ $T_{STG}$	Operating Junction and Storage Temperature Range	-55 to + 150	°C

Notes ① through ⑦ are on page 9

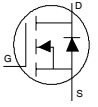
**Static @ T<sub>J</sub> = 25°C (unless otherwise specified)**

	Parameter	Min.	Typ.	Max.	Units	Conditions	
BV <sub>DSS</sub>	Drain-to-Source Breakdown Voltage	30	—	—	V	V <sub>GS</sub> = 0V, I <sub>D</sub> = 250μA	
ΔBV <sub>DSS</sub> /ΔT <sub>J</sub>	Breakdown Voltage Temp. Coefficient	—	0.022	—	V/°C	Reference to 25°C, I <sub>D</sub> = 1.0mA	
R <sub>DS(on)</sub>	Static Drain-to-Source On-Resistance	—	12.2	14.9	mΩ	V <sub>GS</sub> = 10V, I <sub>D</sub> = 10A ③	
		—	16.3	20.4		V <sub>GS</sub> = 4.5V, I <sub>D</sub> = 8.0A ③	
V <sub>GS(th)</sub>	Gate Threshold Voltage	1.35	1.8	2.35	V	V <sub>DS</sub> = V <sub>GS</sub> , I <sub>D</sub> = 25μA	
ΔV <sub>GS(th)</sub>	Gate Threshold Voltage Coefficient	—	-6.3	—	mV/°C		
I <sub>DSS</sub>	Drain-to-Source Leakage Current	—	—	1.0	μA	V <sub>DS</sub> = 24V, V <sub>GS</sub> = 0V	
		—	—	150		V <sub>DS</sub> = 24V, V <sub>GS</sub> = 0V, T <sub>J</sub> = 125°C	
I <sub>GSS</sub>	Gate-to-Source Forward Leakage	—	—	100	nA	V <sub>GS</sub> = 20V	
	Gate-to-Source Reverse Leakage	—	—	-100		V <sub>GS</sub> = -20V	
g <sub>fs</sub>	Forward Transconductance	20	—	—	S	V <sub>DS</sub> = 10V, I <sub>D</sub> = 10A	
Q <sub>g</sub>	Total Gate Charge	—	15	—	nC	V <sub>GS</sub> = 10V, V <sub>DS</sub> = 15V, I <sub>D</sub> = 10A	
Q <sub>g</sub>	Total Gate Charge	—	6.7	—	nC	V <sub>DS</sub> = 15V V <sub>GS</sub> = 4.5V I <sub>D</sub> = 10A	
	Q <sub>gs1</sub>	Pre-V <sub>th</sub> Gate-to-Source Charge	—	2.1			—
	Q <sub>gs2</sub>	Post-V <sub>th</sub> Gate-to-Source Charge	—	1.0			—
	Q <sub>gd</sub>	Gate-to-Drain Charge	—	2.0			—
	Q <sub>godr</sub>	Gate Charge Overdrive	—	1.6			—
Q <sub>sw</sub>	Switch Charge (Q <sub>gs2</sub> + Q <sub>gd</sub> )	—	3.0	—	nC		
Q <sub>oss</sub>	Output Charge	—	7.6	—	nC	V <sub>DS</sub> = 24V, V <sub>GS</sub> = 0V	
R <sub>G</sub>	Gate Resistance	—	1.6	—	Ω		
t <sub>d(on)</sub>	Turn-On Delay Time	—	14	—	ns	V <sub>DD</sub> = 15V, V <sub>GS</sub> = 4.5V I <sub>D</sub> = 10A R <sub>G</sub> = 1.8Ω	
t <sub>r</sub>	Rise Time	—	94	—			
t <sub>d(off)</sub>	Turn-Off Delay Time	—	12	—			
t <sub>f</sub>	Fall Time	—	33	—			
C <sub>iss</sub>	Input Capacitance	—	1165	—	pF	V <sub>GS</sub> = 0V V <sub>DS</sub> = 10V f = 1.0MHz	
C <sub>oss</sub>	Output Capacitance	—	260	—			
C <sub>rss</sub>	Reverse Transfer Capacitance	—	100	—			

**Avalanche Characteristics**

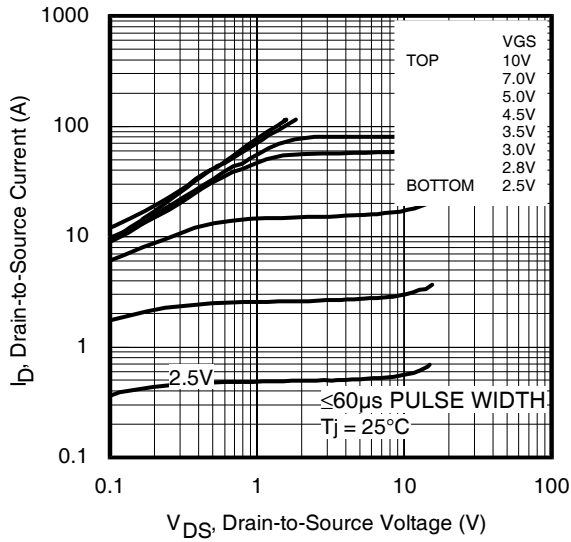
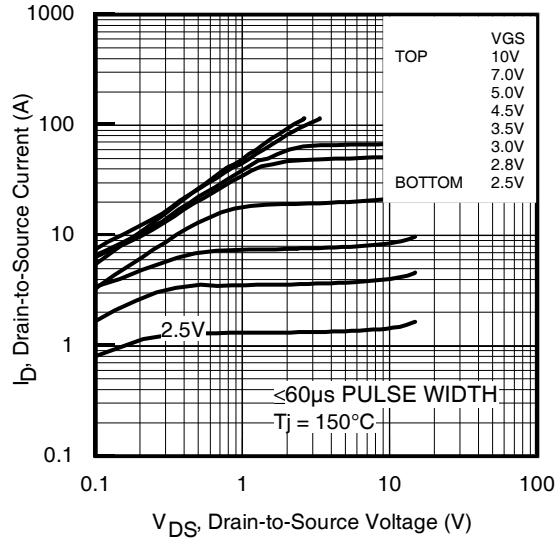
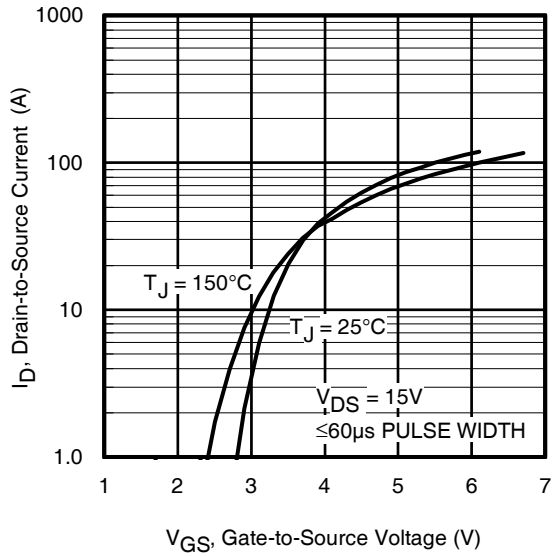
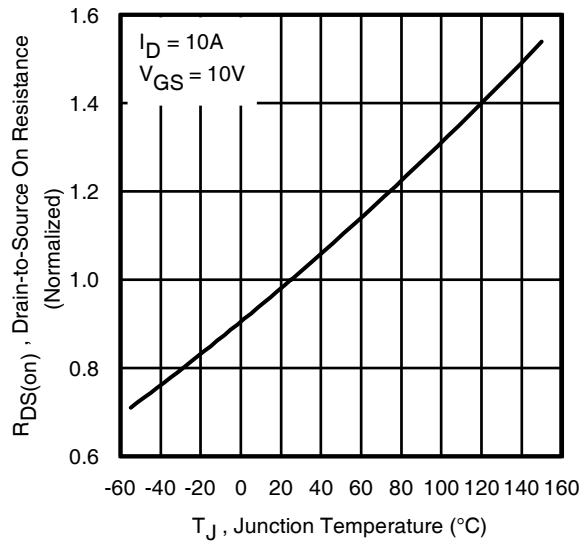
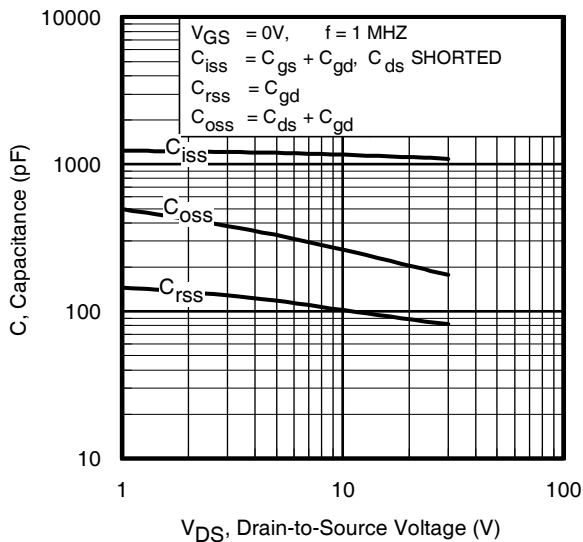
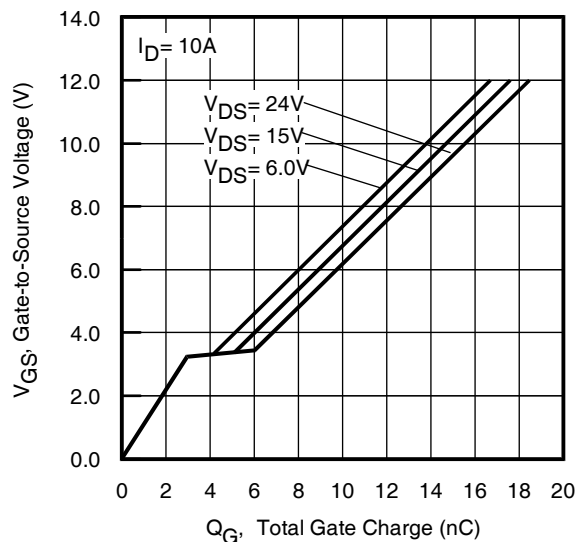
	Parameter	Typ.	Max.	Units
E <sub>AS</sub>	Single Pulse Avalanche Energy ②	—	29	mJ
I <sub>AR</sub>	Avalanche Current ①	—	10	A

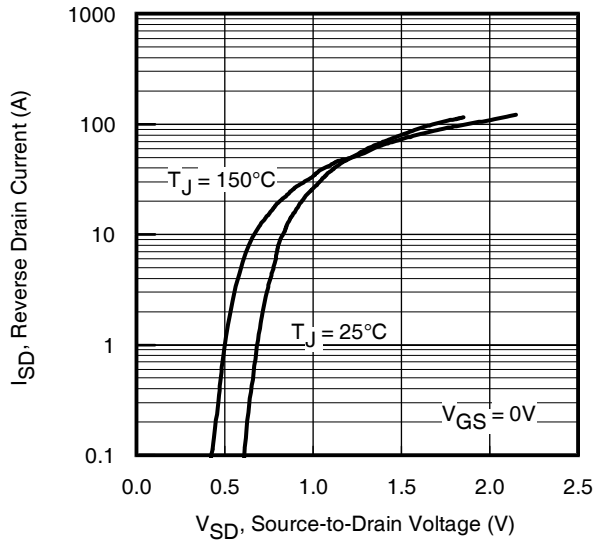
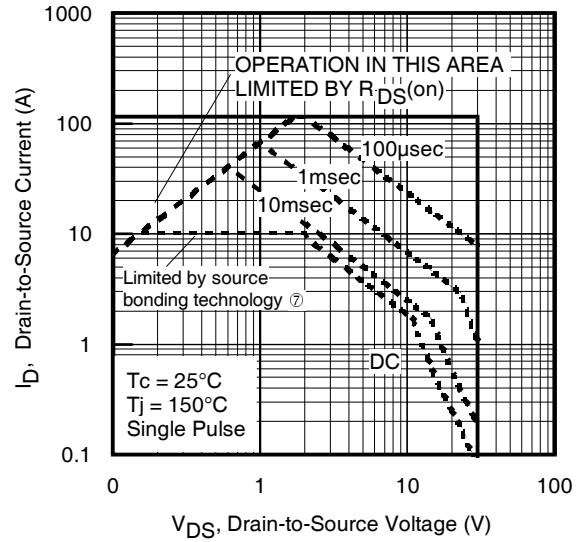
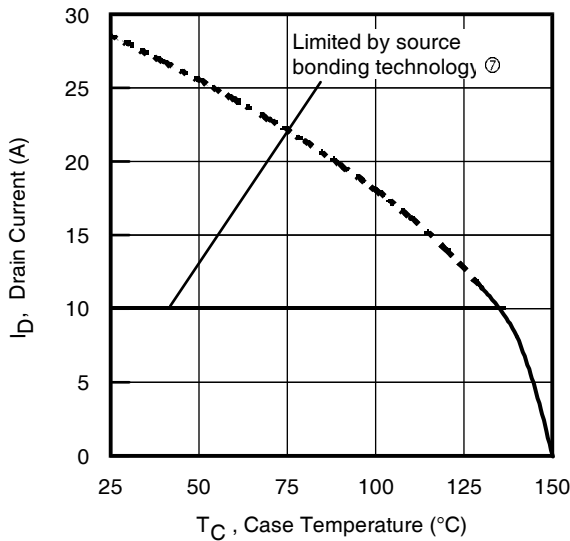
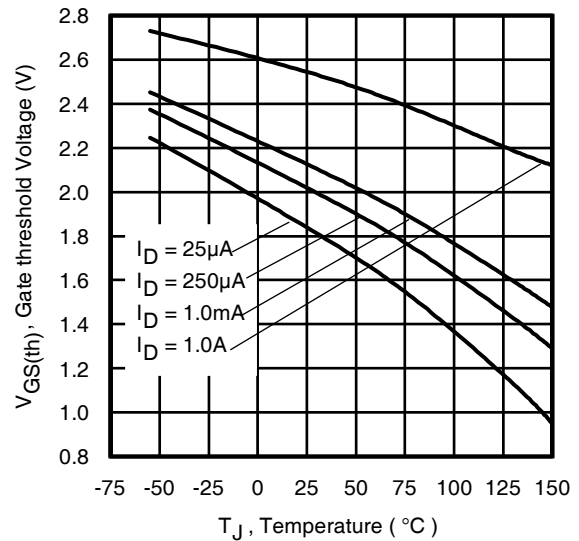
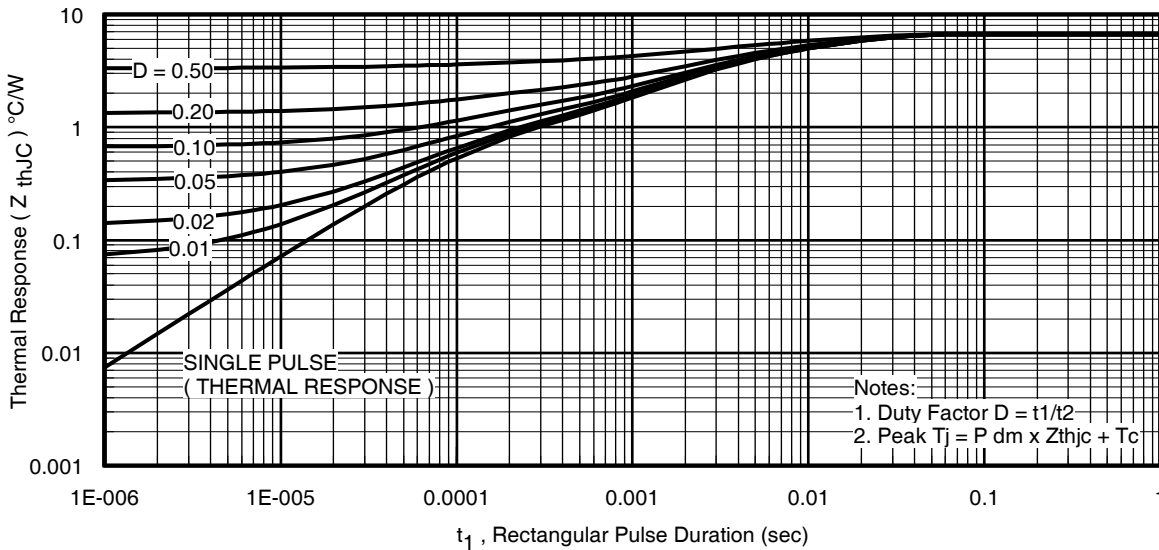
**Diode Characteristics**

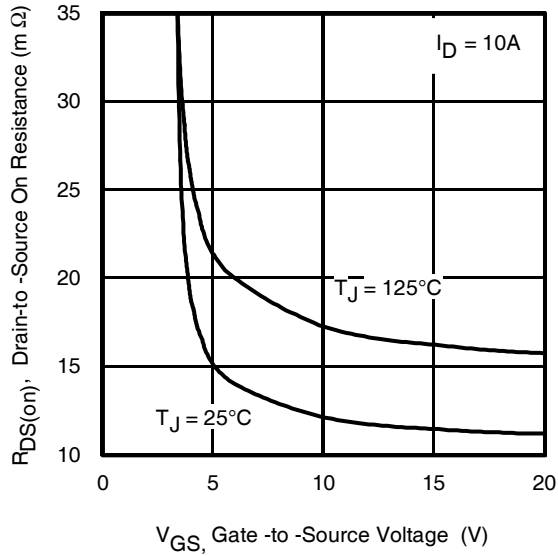
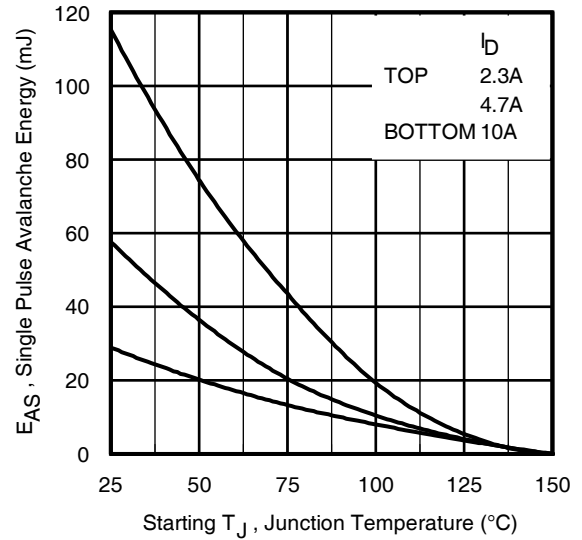
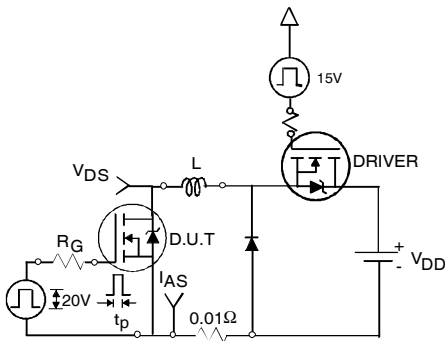
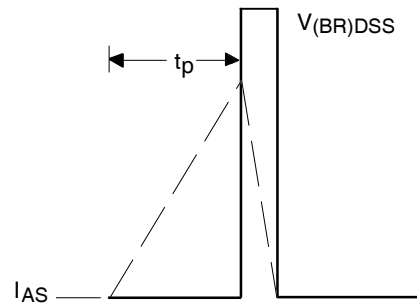
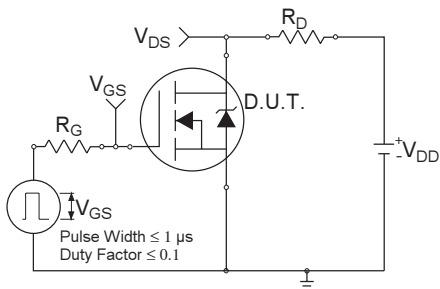
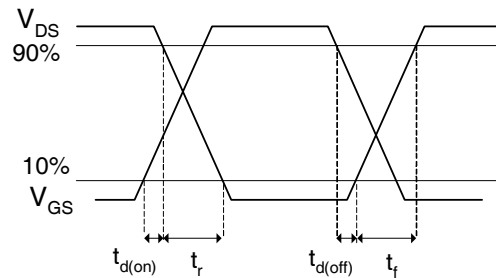
	Parameter	Min.	Typ.	Max.	Units	Conditions
I <sub>S</sub>	Continuous Source Current (Body Diode)	—	—	10 ⑦	A	MOSFET symbol showing the integral reverse p-n junction diode. 
I <sub>SM</sub>	Pulsed Source Current (Body Diode) ①	—	—	116		
V <sub>SD</sub>	Diode Forward Voltage	—	—	1.3	V	T <sub>J</sub> = 25°C, I <sub>S</sub> = 10A, V <sub>GS</sub> = 0V ③
t <sub>rr</sub>	Reverse Recovery Time	—	17	26	ns	T <sub>J</sub> = 25°C, I <sub>F</sub> = 10A, V <sub>DD</sub> = 15V
Q <sub>rr</sub>	Reverse Recovery Charge	—	24	36	nC	di/dt = 280A/μs ③
t <sub>on</sub>	Forward Turn-On Time	Time is dominated by parasitic inductance				

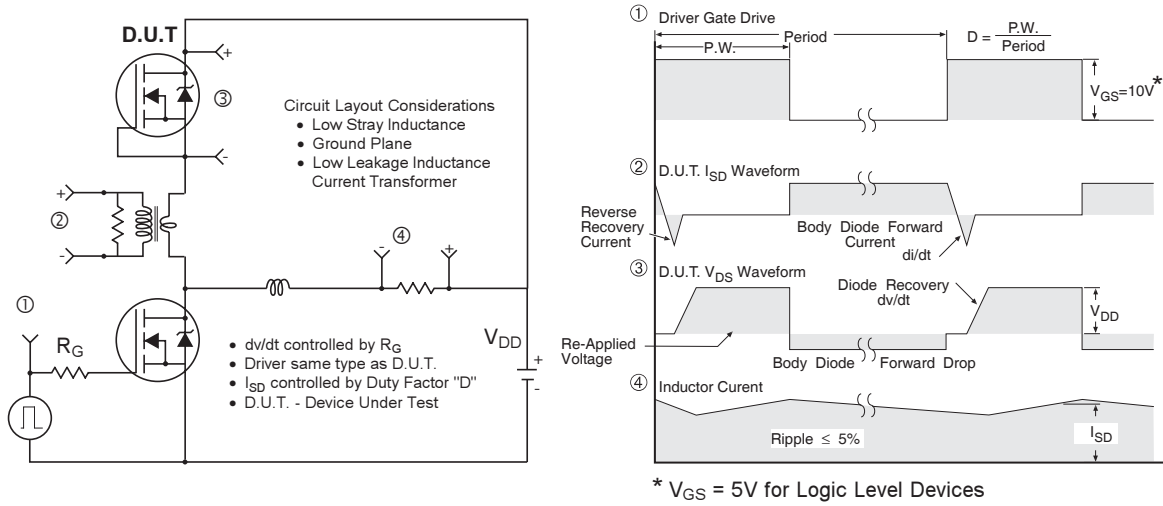
**Thermal Resistance**

	Parameter	Typ.	Max.	Units
R <sub>θJC</sub> (Bottom)	Junction-to-Case ④	—	6.7	°C/W
R <sub>θJC</sub> (Top)	Junction-to-Case ④	—	72	
R <sub>θJA</sub>	Junction-to-Ambient ⑤	—	47	
R <sub>θJA</sub> (<10s)	Junction-to-Ambient ⑤	—	32	

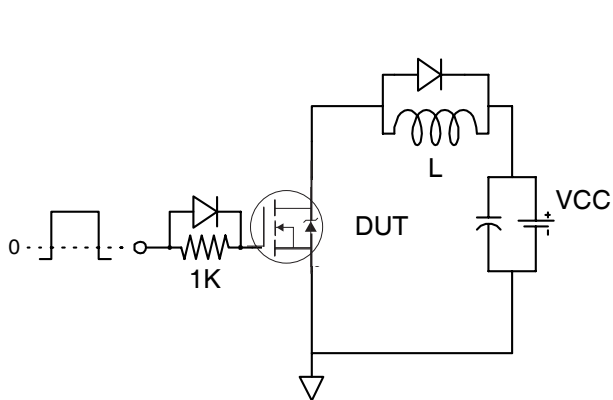

**Fig 1. Typical Output Characteristics**

**Fig 2. Typical Output Characteristics**

**Fig 3. Typical Transfer Characteristics**

**Fig 4. Normalized On-Resistance vs. Temperature**

**Fig 5. Typical Capacitance vs. Drain-to-Source Voltage**

**Fig 6. Typical Gate Charge vs. Gate-to-Source Voltage**


**Fig 7.** Typical Source-Drain Diode Forward Voltage

**Fig 8.** Maximum Safe Operating Area

**Fig 9.** Maximum Drain Current vs. Case (Bottom) Temperature

**Fig 10.** Threshold Voltage vs. Temperature

**Fig 11.** Maximum Effective Transient Thermal Impedance, Junction-to-Case (Bottom)

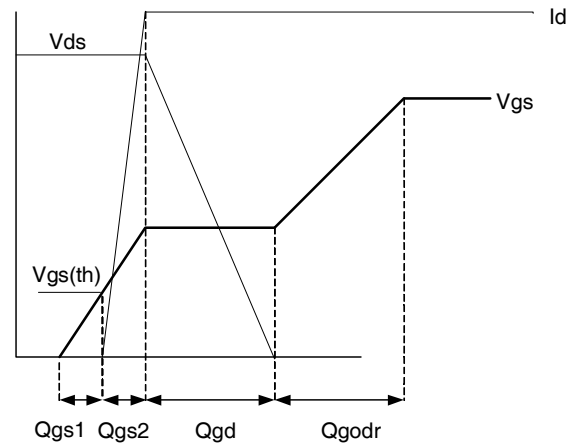

**Fig 12. On-Resistance vs. Gate Voltage**

**Fig 13. Maximum Avalanche Energy vs. Drain Current**

**Fig 14a. Unclamped Inductive Test Circuit**

**Fig 14b. Unclamped Inductive Waveforms**

**Fig 15a. Switching Time Test Circuit**

**Fig 15b. Switching Time Waveforms**



**Fig 16. Peak Diode Recovery  $dv/dt$  Test Circuit for N-Channel HEXFET<sup>®</sup> Power MOSFETs**

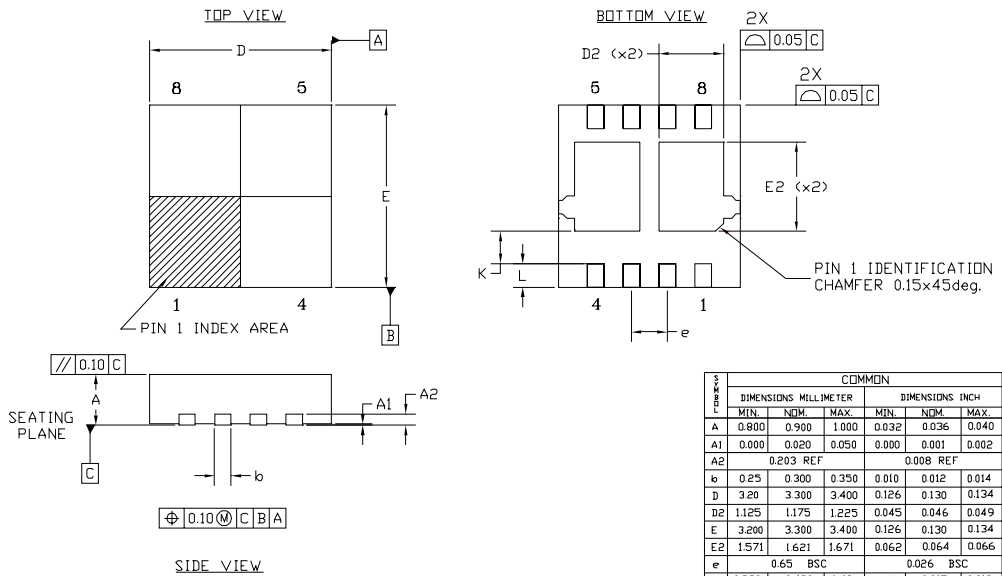


**Fig 17. Gate Charge Test Circuit**



**Fig 18. Gate Charge Waveform**

## PQFN Dual 3.3 x 3.3 Package Details

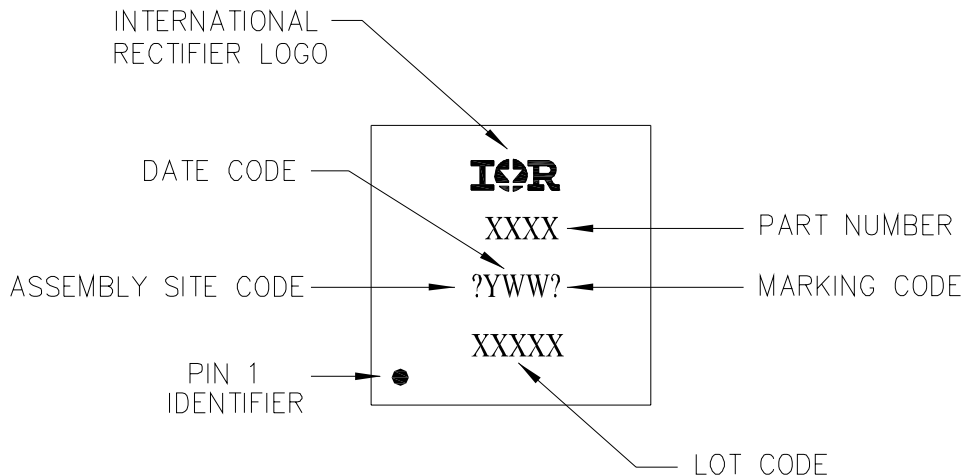


- NOTES :
1. DIMENSION AND TOLERANCING CONFORM TO ASME Y14.5M-1994.
  2. CONTROLLING DIMENSIONS - MILLIMETER. CONVERTED INCH DIMENSION ARE NOT NECESSARILY EXACT.
  3. DIMENSION b APPLIES TO METALLIZED TERMINAL AND IS MEASURED BETWEEN 0.15 AND 0.30 mm FROM TERMINAL TIP.

For more information on board mounting, including footprint and stencil recommendation, please refer to application note AN-1136: <http://www.irf.com/technical-info/appnotes/an-1136.pdf>

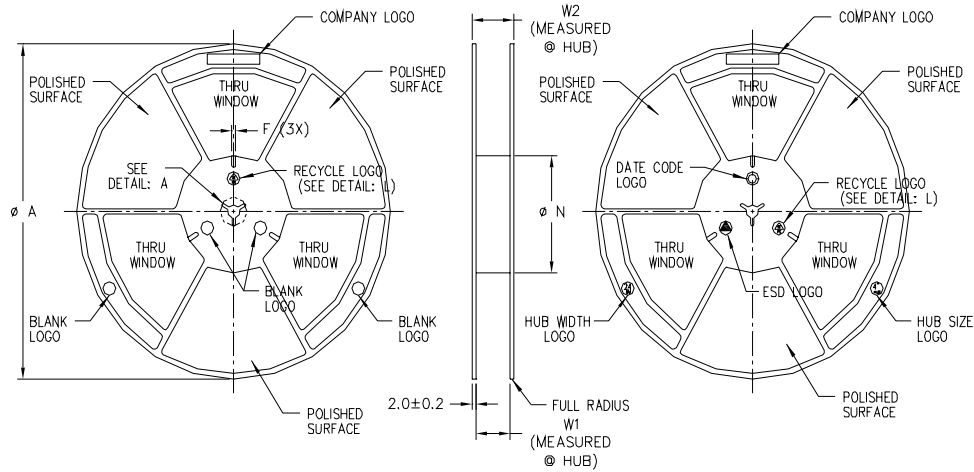
For more information on package inspection techniques, please refer to application note AN-1154: <http://www.irf.com/technical-info/appnotes/an-1154.pdf>

## PQFN Dual 3.3 x 3.3 Part Marking



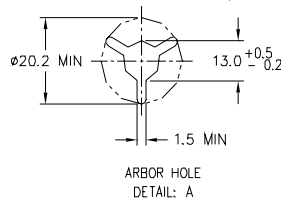
Note: For the most current drawing please refer to IR website at: <http://www.irf.com/package/>

# PQFN Dual 3.3x3.3 Tape and Reel


**NOTES:**

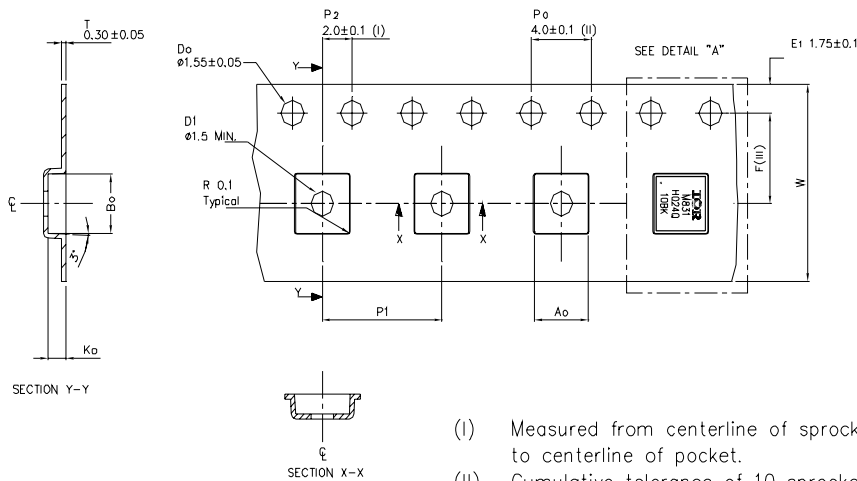
1. GENERIC PRODUCT.
2. FOR PRODUCT DRAWING ONLY.
3. SUNBLAST ALL SURFACE UNLESS OTHERWISE STATED.
4. MOLD 2

LEGEND	SURFACE SR RANGE	RESISTIVITY TYPE	COLOUR
A	BELOW $10^{12}$	ANTISTATIC	ALL TYPES
B	$10^6$ TO $10^{11}$	STATIC DISSIPATIVE	BLACK ONLY
C	$10^5$ & BELOW $10^5$	CONDUCTIVE (GENERIC)	BLACK ONLY
D	$10^5$ TO $10^9$	CONDUCTIVE (CUSTOM)	BLACK ONLY
E	BELOW $10^{12}$	COATED ANTISTATIC	ALL COLOR


**DETAIL: L**

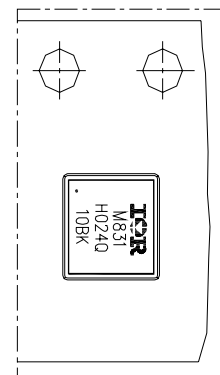
ANTISTATIC (ALL COLORS)  
 STATIC DISSIPATIVE (BLACK)  
 CONDUCTIVE (BLACK)

TAPE WIDTH	PRODUCT SPECIFICATION				
	$\phi$ A $\pm 2.0$	$\phi$ N $\pm 2.0$	W1	W2 (MAX)	E (MIN)
08MM	330	100	$8.4^{+1.5}_{-0.0}$	14.4	2.5
12MM	330	100	$12.4^{+2.0}_{-0.0}$	18.4	2.5
16MM	330	100	$16.4^{+2.0}_{-0.0}$	22.4	2.5
24MM	330	100	$24.4^{+2.0}_{-0.0}$	30.4	2.5
32MM	330	100	$32.4^{+2.0}_{-0.0}$	38.4	2.5



A <sub>0</sub>	3.60 +/- 0.1
B <sub>0</sub>	3.60 +/- 0.1
K <sub>0</sub>	1.20 +/- 0.1
F	5.50 +/- 0.1
P <sub>1</sub>	8.00 +/- 0.1
W	12.00 +/- 0.3

- (I) Measured from centerline of sprocket hole to centerline of pocket.
- (II) Cumulative tolerance of 10 sprocket holes is  $\pm 0.20$ .
- (III) Measured from centerline of sprocket hole to centerline of pocket.
- (IV) Other material available.
- (V) Typical SR of form tape Max  $10^9$  OHM/SQ

**DETAIL "A"**




**Qualification information<sup>†</sup>**

Qualification level	Industrial (per JEDEC JESD47F <sup>†††</sup> guidelines)	
Moisture Sensitivity Level	PQFN Dual 3.3mm x 3.3mm	MSL1 (per JEDEC J-STD-020D <sup>††</sup> )
RoHS compliant	Yes	

† Qualification standards can be found at International Rectifier's web site  
<http://www.irf.com/product-info/reliability>

†† Applicable version of JEDEC standard at the time of product release.

**Notes:**

- ① Repetitive rating; pulse width limited by max. junction temperature.
- ② Starting  $T_J = 25^\circ\text{C}$ ,  $L = 0.58\text{mH}$ ,  $R_G = 50\Omega$ ,  $I_{AS} = 10\text{A}$ .
- ③ Pulse width  $\leq 400\mu\text{s}$ ; duty cycle  $\leq 2\%$ .
- ④  $R_\theta$  is measured at  $T_J$  of approximately  $90^\circ\text{C}$ .
- ⑤ When mounted on 1 inch square PCB (FR-4). Please refer to AN-994 for more details:  
<http://www.irf.com/technical-info/appnotes/an-994.pdf>
- ⑥ Calculated continuous current based on maximum allowable junction temperature.
- ⑦ Current is limited to 10A by source bonding technology.

**Revision History**

Date	Comment
1/9/2014	<ul style="list-style-type: none"> <li>• Updated ordering information to reflect the End-Of-Life (EOL) of the mini-reel option (EOL notice #259).</li> <li>• Updated data sheet with the new IR corporate template.</li> </ul>
2/4/2014	<ul style="list-style-type: none"> <li>• Change the qualification level from Consumer to Industrial, on pages 1 &amp; 9.</li> </ul>

## X-ON Electronics

Largest Supplier of Electrical and Electronic Components

*Click to view similar products for [MOSFET](#) category:*

*Click to view products by [Infineon](#) manufacturer:*

Other Similar products are found below :

[614233C](#) [648584F](#) [MCH3443-TL-E](#) [MCH6422-TL-E](#) [FDPF9N50NZ](#) [FW216A-TL-2W](#) [FW231A-TL-E](#) [APT5010JVR](#) [NTNS3A92PZT5G](#)  
[IRF100S201](#) [JANTX2N5237](#) [2SK2464-TL-E](#) [2SK3818-DL-E](#) [FCA20N60\\_F109](#) [FDZ595PZ](#) [STD6600NT4G](#) [FSS804-TL-E](#) [2SJ277-DL-E](#)  
[2SK1691-DL-E](#) [2SK2545\(Q,T\)](#) [D2294UK](#) [405094E](#) [423220D](#) [MCH6646-TL-E](#) [TPCC8103,L1Q\(CM](#) [367-8430-0972-503](#) [VN1206L](#)  
[424134F](#) [026935X](#) [051075F](#) [SBVS138LT1G](#) [614234A](#) [715780A](#) [NTNS3166NZT5G](#) [751625C](#) [873612G](#) [IRF7380TRHR](#)  
[IPS70R2K0CEAKMA1](#) [RJK60S3DPP-E0#T2](#) [RJK60S5DPK-M0#T0](#) [APT5010JVFR](#) [APT12031JFLL](#) [APT12040JVR](#) [DMN3404LQ-7](#)  
[NTE6400](#) [JANTX2N6796U](#) [JANTX2N6784U](#) [JANTXV2N5416U4](#) [SQM110N05-06L-GE3](#) [SIHF35N60E-GE3](#)