

Opto Plus LED Corp.
0.4" Case Mold Type LED Display
OPD-S4030LB-BW
OPD-S4031LB-BW

● **FEATURES**

- 0.4 inch (10.16 mm) Digit Height.
- Low current operation.
- Case mold type.
- Black face, White segment.
- RoHS compliant, Pb Free.

● **DESCRIPTION**

The OPD-S4030LB-BW & OPD-S4031LB-BW are 0.4 inch (10.16 mm) height single 7-segment display.

This device utilizes Super Bright Blue LED chip which are made from InGaN on a transparent GaN substrate.

The display has Black face, White segment.

● **DEVICE**

| PART NO | DESCRIPTION |
|-------------------|--------------------|
| Super Bright Blue | |
| OPD-S4030LB-BW | Common Anode |
| OPD-S4031LB-BW | Common Cathode |

RoHS Compliance



Pb free.



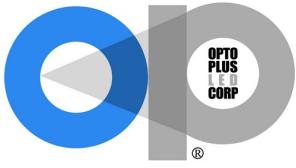

Opto Plus LED Corp.

0.4" Case Mold Type LED Display

OPD-S4030LB-BW

OPD-S4031LB-BW

MECHANICAL DIMENSIONS

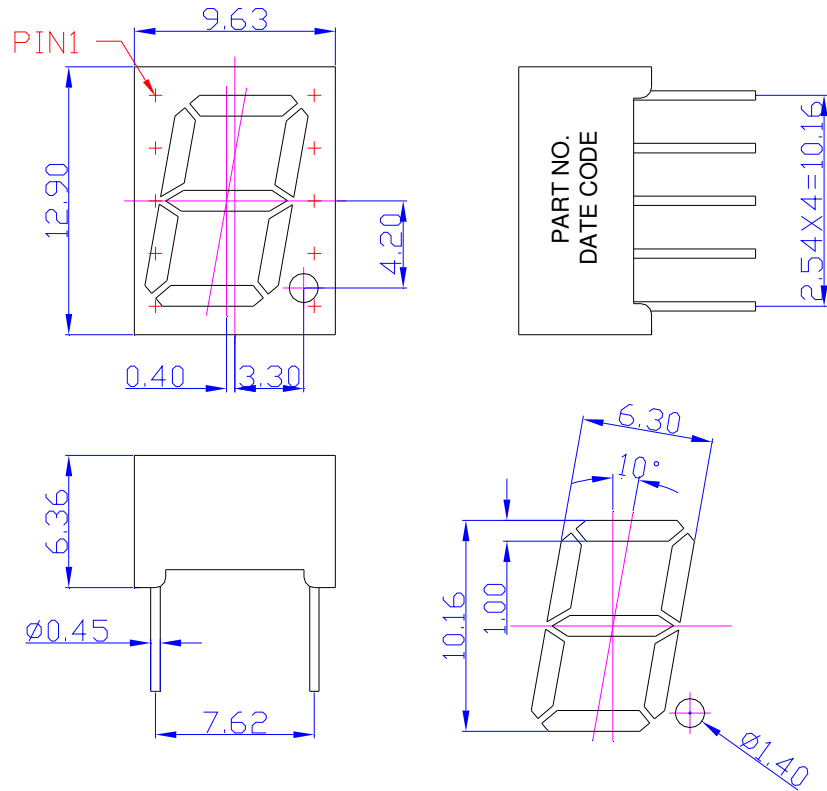

NOTES: Dimension is in millimeters. Tolerance is ± 0.25 mm unless otherwise noted.

TYPICAL INTERNAL EQUIVALENT CIRCUIT

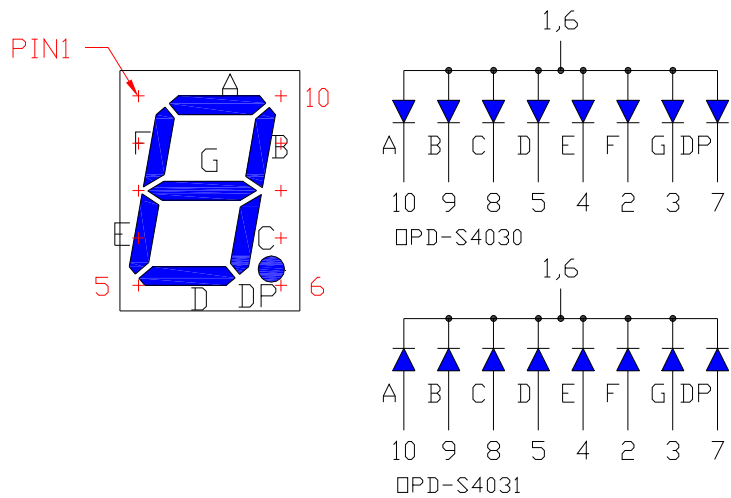

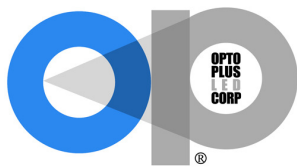

Opto Plus LED Corp.
0.4" Case Mold Type LED Display
OPD-S4030LB-BW
OPD-S4031LB-BW

● **LB: SUPER BRIGHT BLUE (InGaN/GaN)**

ABSOLUTE MAXIMUM RATING AT Ta=25°C

| Parameter | Symbol | Super Bright Blue | Unit |
|---|------------------|-------------------|---------|
| Power dissipation per dice | P _{AD} | 120 | mW |
| Derating liner from 25°C per dice | - | 0.4 | mA / °C |
| Continuous forward current per dice | I _{AF} | 30 | mA |
| Peak current per dice (duty cycle 1/10, 1kHz) | I _{PF} | 100 | mA |
| Reverse voltage per dice | V _R | 5 | V |
| Operating temperature | T _{OPR} | -25 to +85 | °C |
| Storage temperature | T _{STG} | -25 to +85 | °C |

ELECTRICAL - OPTICAL CHARACTERISTICS AT Ta=25°C

| Characteristic | Symbol | Condition | Min. | Typ. | Max. | Unit |
|------------------------------|----------------|----------------------|------|------|------|------|
| Forward voltage | V _F | I _F =20mA | - | 3.2 | 4.0 | V |
| Reverse current | I _R | V _R =8V | - | - | 10 | μA |
| Dominant wavelength | λ _D | I _F =20mA | - | 470 | - | nm |
| Luminous intensity | I _v | I _F =20mA | - | 60 | - | mcd |
| Spectral radiation bandwidth | Δλ | I _F =20mA | - | 30 | - | nm |

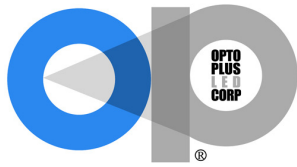

Opto Plus LED Corp.

0.4" Case Mold Type LED Display

OPD-S4030LB-BW

OPD-S4031LB-BW

● LB: SUPER BRIGHT BLUE (InGaN/GaN) CURVE

Typical Electro-optical Characteristic Curves
(25 °C Free Air Temperature Unless Otherwise Specified)

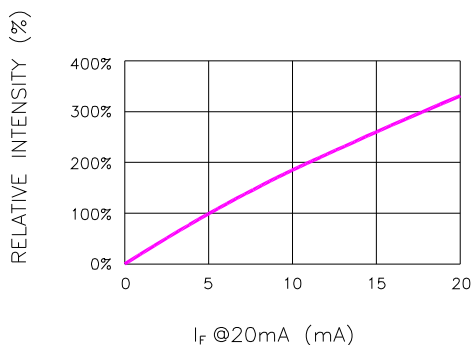

Fig.1 RELATIVE INTENSITY VS. FORWARD CURRENT

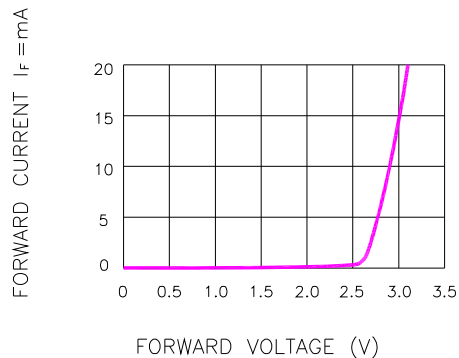

Fig.2 FORWARD CURRENT VS. FORWARD VOLTAGE

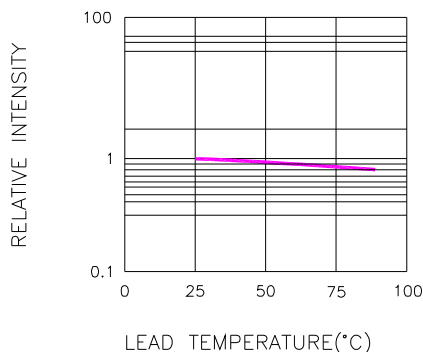

Fig.3 RELATIVE INTENSITY VS. LEAD TEMPERATURE
(PULSED 20 mA; 300us PULSE, 10ms PERIOD)

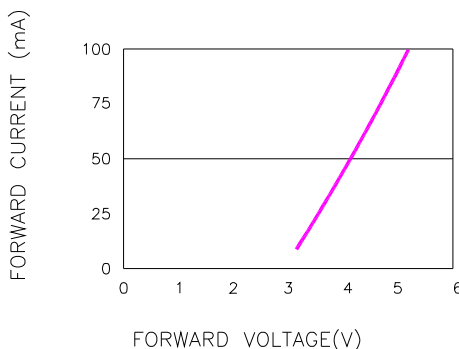

Fig.4 PEAK FORWARD VOLTAGE VS. FORWARD (100us TEST PULSE, 1% DUTY CYCLE)

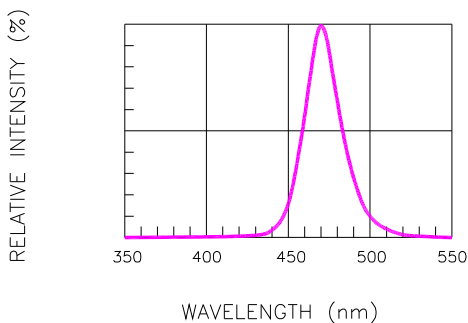

Fig.5 RELATIVE INTENSITY VS. WAVELENGTH

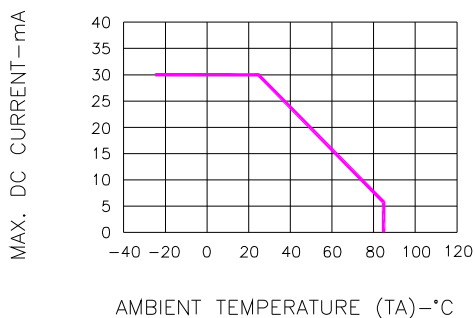
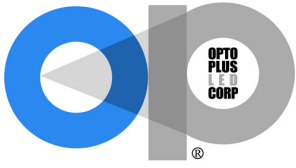
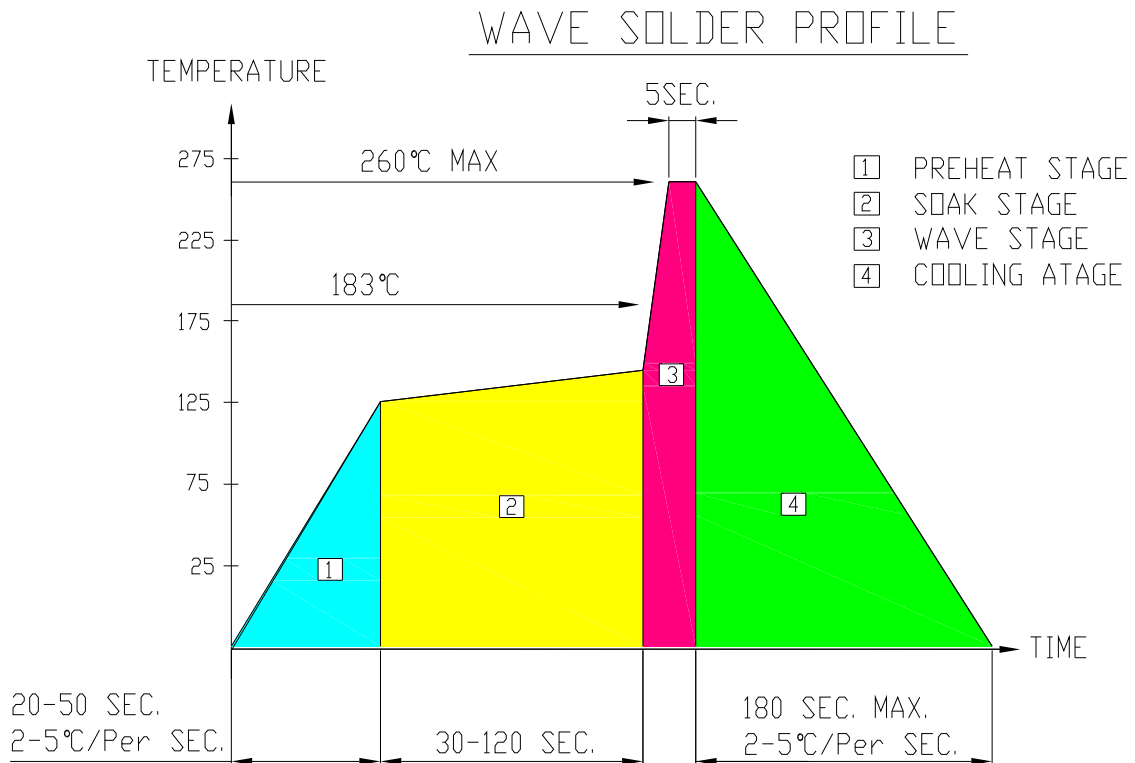

Fig.6 MAX. ALLOWABLE DC CURRENT VS. AMBIENT TEMPERATURE



Opto Plus LED Corp.
0.4" Case Mold Type LED Display
OPD-S4030LB-BW
OPD-S4031LB-BW

● **RECOMMEND SOLDERING PROFILE**



● **SOLDERING IRON**

Basic spec is ≤ 4 sec when 260°C. If temperature is higher, time should be shorter (+10°C→1 sec). Power dissipation of Iron should be smaller than 15W, and temperature should be controllable. Surface temperature of the device should be under 230°C.

● **REWORK**

Customer must finish rework within ≤ 4 sec under 245°C.

X-ON Electronics

Largest Supplier of Electrical and Electronic Components

Click to view similar products for [LED Displays & Accessories](#) category:

Click to view products by [Opto Plus Led Corp](#) manufacturer:

Other Similar products are found below :

[LTC-2721WC](#) [LTC-4624JD](#) [LTC-4627G](#) [LTC-4627WC](#) [LTD-5021AWC](#) [LTM-8522G](#) [LTP-4323P](#) [LTP-747G](#) [LTS-3361JG-06](#)
[F416SYGWA/S530-E3](#) [EADST040RA2](#) [1668](#) [HT-F196NB-5323](#) [IPD2131-27](#) [SA03-12EWA](#) [LDD-E2802RD](#) [LDD-E306MI](#) [LDQ-N514RI](#)
[LDS-A3506RD](#) [LDS-A3926RI](#) [LDT-M516RI](#) [SC03-12HDB](#) [SI-B9T151550WW](#) [SI-B9V171550WW](#) [SLC-3PF-WL](#) [1624](#) [LTC-2621JD](#)
[LTC-2623WC](#) [LTC-4624P](#) [LTC-4627JD](#) [LTD-2601E](#) [LTD-322G](#) [LTD-482PC](#) [LTP-1457AKR](#) [LTP-3784G-01](#) [LTS-313AP](#) [LTS-4812SKR-](#)
[P](#) [LTS-547AE](#) [LTS-6780P](#) [446010401-3](#) [HV-7W30-6829](#) [CA12240_MINNIE-WWW-MTG-ASSY](#) [DA43-11GWA](#) [LDD-A516RI-17](#) [LDD-](#)
[E305RI](#) [LDQ-M513RI](#) [LDQ-M5204RI-SI](#) [LDQ-N3402RI](#) [LDQ-N3606RI](#) [LDS-A3924RI-SI](#)