



Opto Plus LED Corp.
0.8" Case Mold Type LED Display
OPD-S8022LR-BW
OPD-S8023LR-BW

● **FEATURES**

- 0.8 inch (20.4 mm) Digit Height.
- Low current operation.
- Case mold type.
- Black face, White segment.
- RoHS compliant, Pb Free.

● **DESCRIPTION**

The OPD-S8022LR-BW & OPD-S8023LR-BW is a 0.8 inch (20.4 mm) height single 7-segment display.

This device utilizes Super Red LED chip which are made from AlGaInP on a transparent GaAs substrate. The display has Black face, White segment.

● **DEVICE**

| PART NO Super Red | DESCRIPTION |
|-----------------------------|--------------------|
| OPD-S8022LR-BW | Common Anode |
| OPD-S8023LR-BW | Common Cathode |

RoHS Compliance



Pb free.





Opto Plus LED Corp.

0.8" Case Mold Type LED Display

OPD-S8022LR-BW

OPD-S8023LR-BW

MECHANICAL DIMENSIONS

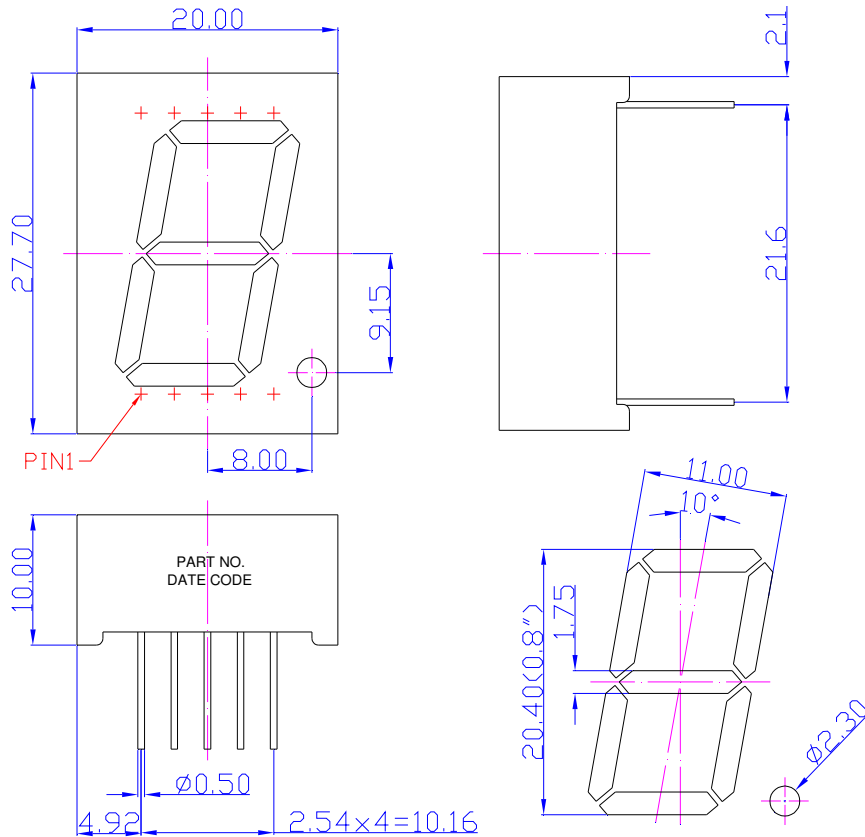

NOTES: All dimensions are in millimeters. Tolerances are ± 0.25 mm unless otherwise noted.

TYPICAL INTERNAL EQUIVALENT CIRCUIT

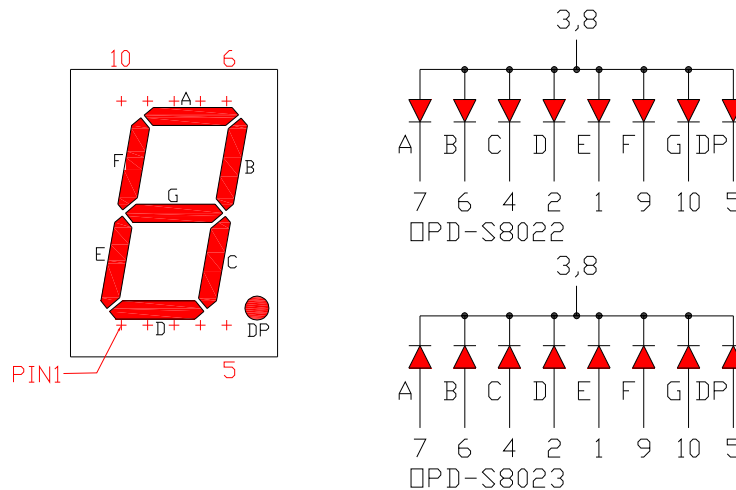



Opto Plus LED Corp.
0.8" Case Mold Type LED Display
OPD-S8022LR-BW
OPD-S8023LR-BW

● **LR: SUPER RED (AlGaInP/GaAs)**

ABSOLUTE MAXIMUM RATING AT Ta=25°C

| Parameter | Symbol | Super Red | Unit |
|---|------------------|------------|---------|
| Power dissipation per dice | P _{AD} | 70 | mW |
| Derating liner from 25 °C per dice | - | 0.33 | mA / °C |
| Continuous forward current per dice | I _{AF} | 25 | mA |
| Peak current per dice (duty cycle 1/10, 1kHz) | I _{PF} | 90 | mA |
| Reverse voltage per dice | V _R | 5 | V |
| Operating temperature | T _{OPR} | -25 to +85 | °C |
| Storage temperature | T _{STG} | -25 to +85 | °C |

ELECTRICAL - OPTICAL CHARACTERISTICS AT Ta=25°C

| Characteristic | Symbol | Condition | Min. | Typ. | Max. | Unit |
|------------------------------|----------------|----------------------|------|------|------|------|
| Forward voltage | V _F | I _F =20mA | - | 2.0 | 2.6 | V |
| Reverse current | I _R | V _R =5V | - | - | 10 | μA |
| Peak wavelength | λ _P | I _F =20mA | - | 650 | - | nm |
| Dominant wavelength | λ _D | I _F =20mA | - | 639 | - | nm |
| Luminous intensity | I _V | I _F =20mA | - | 35 | - | mcd |
| Spectral radiation bandwidth | Δλ | I _F =20mA | - | 20 | - | nm |



Opto Plus LED Corp.

0.8" Case Mold Type LED Display

OPD-S8022LR-BW

OPD-S8023LR-BW

● LR: SUPER RED (AlGaInP/GaAs)

Typical Electro-optical Characteristic Curves
(25 °C Free Air Temperature Unless Otherwise Specified)

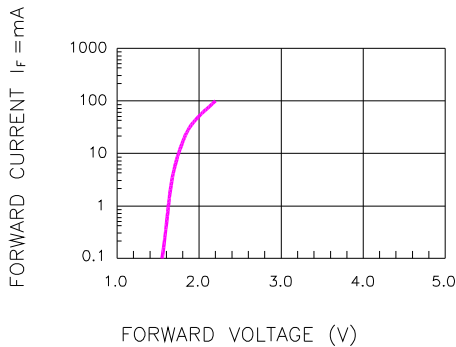

Fig.1 FORWARD CURRENT VS. FORWARD VOLTAGE

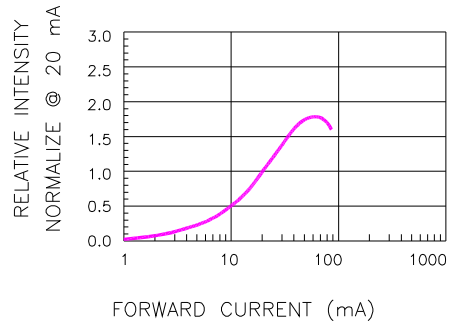

Fig.2 RELATIVE INTENSITY VS. FORWARD CURRENT

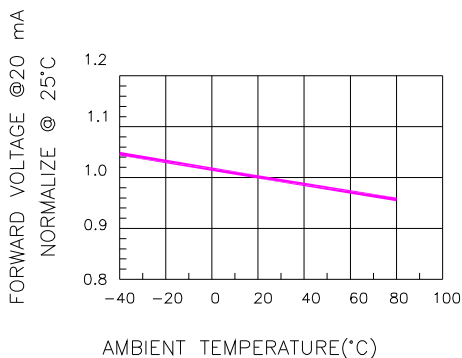

Fig.3 FORWARD VOLTAGE VS. TEMPERATURE

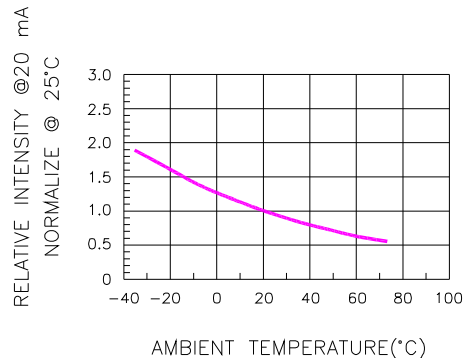

Fig.4 RELATIVE INTENSITY VS. TEMPERATURE

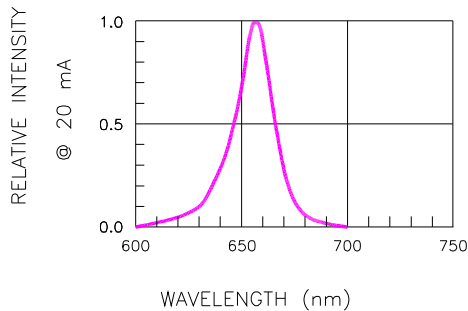

Fig.5 RELATIVE INTENSITY VS. WAVELENGTH

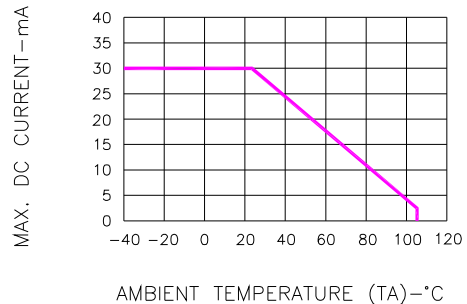

Fig.6 MAX. ALLOWABLE DC CURRENT VS. AMBIENT TEMPERATURE



Opto Plus LED Corp.
0.8" Case Mold Type LED Display
OPD-S8022LR-BW
OPD-S8023LR-BW

● **RECOMMEND SOLDERING PROFILE**



● **SOLDERING IRON**

Basic spec is ≤ 4 sec when 260°C . If temperature is higher, time should be shorter ($+10^{\circ}\text{C} \rightarrow 1$ sec). Power dissipation of Iron should be smaller than 15W, and temperature should be controllable. Surface temperature of the device should be under 230°C .

● **REWORK**

Customer must finish rework within ≤ 4 sec under 245°C .

X-ON Electronics

Largest Supplier of Electrical and Electronic Components

Click to view similar products for [LED Displays & Accessories](#) category:

Click to view products by [Opto Plus Led Corp](#) manufacturer:

Other Similar products are found below :

[LTC-2721WC](#) [LTC-4624JD](#) [LTC-4627G](#) [LTC-4627WC](#) [LTD-5021AWC](#) [LTM-8522G](#) [LTP-4323P](#) [LTP-747G](#) [LTS-3361JG-06](#)
[F416SYGWA/S530-E3](#) [EADST040RA2](#) [1668](#) [HT-F196NB-5323](#) [IPD2131-27](#) [SA03-12EWA](#) [LDD-E2802RD](#) [LDD-E306MI](#) [LDQ-N514RI](#)
[LDS-A3506RD](#) [LDS-A3926RI](#) [LDT-M516RI](#) [SC03-12HDB](#) [SI-B9T151550WW](#) [SI-B9V171550WW](#) [SLC-3PF-WL](#) [1624](#) [LTC-2621JD](#)
[LTC-2623WC](#) [LTC-4624P](#) [LTC-4627JD](#) [LTD-2601E](#) [LTD-322G](#) [LTD-482PC](#) [LTP-1457AKR](#) [LTP-3784G-01](#) [LTS-313AP](#) [LTS-4812SKR-](#)
[P](#) [LTS-547AE](#) [LTS-6780P](#) [446010401-3](#) [HV-7W30-6829](#) [CA12240_MINNIE-WWW-MTG-ASSY](#) [DA43-11GWA](#) [LDD-A516RI-17](#) [LDD-](#)
[E305RI](#) [LDQ-M513RI](#) [LDQ-M5204RI-SI](#) [LDQ-N3402RI](#) [LDQ-N3606RI](#) [LDS-A3924RI-SI](#)