

■ Features

- High Luminous LEDs
 - 3mm Round Standard Directivity
 - Superior Weather-resistance
 - UV Resistant Epoxy
 - Integral Current Limiting Resistor
 - TTL Compatible (Requires No External Current Limiter With 12 Volt Supply)
 - Cost Effective (Saves Space and Resistor Cost)
 - Water clear Type
- ### ■ Applications
- Status Indicators
 - Other Lighting

■ Outline Dimension

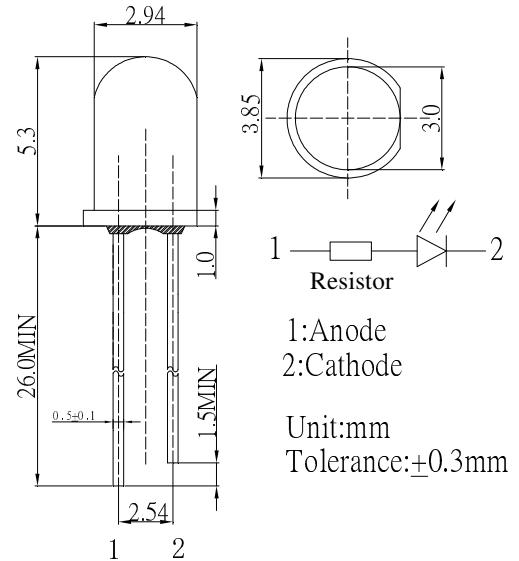

■ Absolute Maximum Rating

(Ta=25°C)





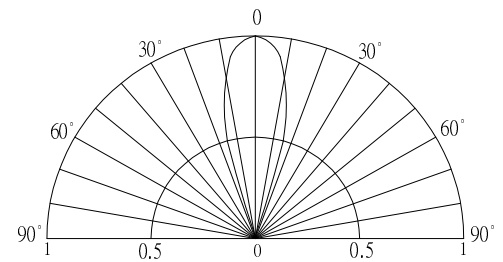

Item	Symbol	Value	Unit
DC Forward Voltage	V _F	15	V
Reverse Voltage	V _R	12	V
Power Dissipation	P _D	225	mW
Operating Temperature	Topr	-30 ~ +85	°C
Storage Temperature	Tstg	-30 ~ +85	°C
Lead Soldering Temperature	Tsol	260°C/5sec	-

■ Directivity



■ Electrical -Optical Characteristics

(Ta=25°C)

Part Number	Color			I _F (mA)			I _v (mcd)*			λD(nm)*			2θ1/2(deg)
				Min	Typ.	Max.	Min.	Typ.	Max.	Min.	Typ.	Max.	Typ.
				V _F =12V			V _F =12V						
OSW5DK3131A-12V	White	W		-	10	15	3000	4200	-	X=0.27, Y=0.28		30	
OSM5DK3131A-12V	Warm White	M		-	10	15	2180	3000	-	X=0.45, Y=0.41		30	
OSK5DK3131A-12V	Pink	K		-	10	15	1120	1560	-	X=0.45, Y=0.17		30	
OSB5SA3131A-12V	Blue	B		-	10	15	1560	2180	-	465	470	475	30
OSG5DA3131A-12V	Pure Green	TG		-	10	15	3000	4200	-	520	525	530	30
OSG8HA3131A-12V	Yellow Green	G		-	10	15	500	750	-	565	570	575	30
OSY5RU3131A-12V	Yellow	Y		-	10	15	1120	1560	-	585	590	595	30
OSO5JA3131A-12V	Orange	O		-	10	15	1120	1560	-	600	605	610	30
OSR5RU3131A-12V	Red	R		-	10	15	1120	1560	-	620	625	630	30

*1 Tolerance of chromaticity coordinates is ±10%

*2 Tolerance of luminous intensity is ±15%

X-ON Electronics

Largest Supplier of Electrical and Electronic Components

Click to view similar products for [Standard LEDs - Through Hole category:](#)

Click to view products by [Optosupply manufacturer:](#)

Other Similar products are found below :

[LTL-10254W](#) [LTL-1214A](#) [LTL-1BEDJ](#) [LTL-2231AT](#) [LTL-3251A](#) [LTL-4262N](#) [LTL-5234](#) [LTL87HTBK](#) [LTL-87HD4B](#) [7383/V7C3-BSTA-L/PR3/MS](#) [G22041431007J2C000](#) [HLMP-AG64-X10ZZ](#) [HLMP-EG1A-Z10DV](#) [HLMP-EL3B-WXKDD](#) [HLMP-HB74-UVBDD](#) [HLMP-HG65-VY0DD](#) [HLMP-HM74-34CDD](#) [HLMP-HM75-34CDD](#) [1L0532V23G0TD001](#) [NSPW500CS](#) [C4SMA-BGF-CQ34Q3C2](#) [L53GC13](#) [264-7SURTS530-A3](#) [L-C150JRCT](#) [S4SMS-BJF-CQ42QGF2](#) [S4SMS-GJF-CW12QMF2](#) [LD CQDP-1U3U-W5-1-K](#) [LNX998CKBDA](#) [LO566UHR3-70G-A3](#) [SLA560WBD2PT3](#) [LP379PPG1C0G0300001](#) [SLR-322MCT32](#) [SLR-342DUT32](#) [SLR-342MC3F](#) [SLR343BC7TT32](#) [SLR343BCTT32](#) [SLX-LX3044GD](#) [SLX-LX3044ID](#) [SLX-LX3044YD](#) [SNW-LX504SRC/4](#) [1.90690.3330000](#) [SSL-LX20483ID](#) [SSL-LX3034YD](#) [SSL-LX5093LGT-11](#) [SSL-LX5093PGC](#) [SSL-LX5093SRC/F](#) [SSL-LX5093SYT](#) [SSL-LX509E3SIT](#) [SSL-LX509FT3ID](#) [SSL-LX50FT3GD](#)