

**■Features**

- High Luminous LEDs
- 3mm Round Standard Directivity
- Long Lifetime Operation
- Superior Weather-resistance
- Water Clear Type

**■Applications**

- Backlighting (switches, keys, displays, illuminated advertising etc.)
- Substitution of Micro Incandescent Lamps
- Reading Lamps / Emergency Lighting
- Marker lights (e.g. steps, exit ways, etc.)
- Other Lighting

**■Absolute Maximum Rating**

(Ta=25 )

Item	Symbol	Value	Unit
DC Forward Current	I <sub>F</sub>	30	mA
Pulse Forward Current*	I <sub>FP</sub>	100	mA
Reverse Voltage	V <sub>R</sub>	5	V
Power Dissipation	P <sub>D</sub>	108	mW
Operating Temperature	T <sub>opr</sub>	-30 ~ +85	
Storage Temperature	T <sub>stg</sub>	-40 ~ +100	
Lead Soldering Temperature	T <sub>sol</sub>	260 /5sec	-

\*Pulse width Max.10ms Duty ratio max 1/10

**■Outline Dimension**

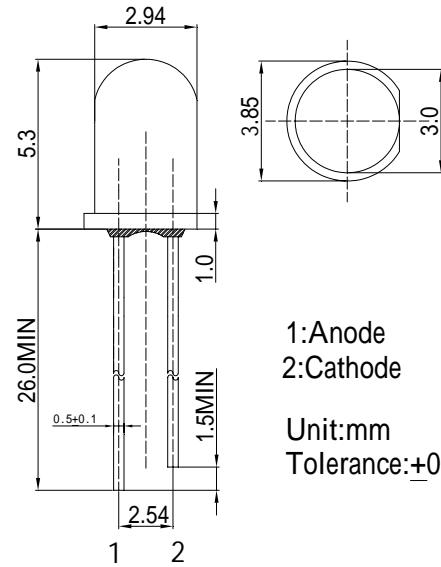

1:Anode  
2:Cathode

Unit:mm  
Tolerance:±0.3mm

**■Directivity**

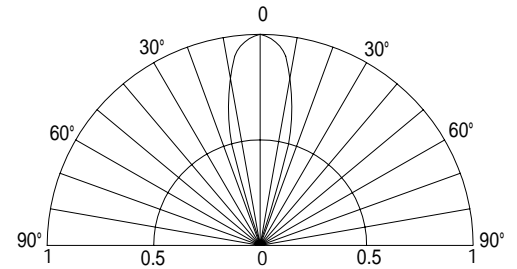

**Electrical -Optical Characteristics**

(Ta=25 )

Item	Symbol	Condition	Min.	Typ.	Max.	Unit
DC Forward Voltage	V <sub>F</sub>	I <sub>F</sub> =20mA	2.8	3.1	3.6	V
DC Reverse Current	I <sub>R</sub>	V <sub>R</sub> =5V	-	-	10	μA
Luminous Flux	v	I <sub>F</sub> =20mA	5.0	5.4	-	lm
Chromaticity Coordinates*	x	I <sub>F</sub> =20mA	-	0.29	-	
	y	I <sub>F</sub> =20mA	-	0.23	-	
50% Power Angle	2θ <sub>1/2</sub>	I <sub>F</sub> =20mA	-	30	-	deg

\*1 Luminous Flux Measurement allowance is ± 15%

\*2 Chromaticity Coordinates Measurement allowance is ± 10%

## X-ON Electronics

Largest Supplier of Electrical and Electronic Components

*Click to view similar products for [Standard LEDs - Through Hole category:](#)*

*Click to view products by [Optosupply manufacturer:](#)*

Other Similar products are found below :

[LTL-10254W](#) [LTL-1214A](#) [LTL-1BEDJ](#) [LTL-2231AT](#) [LTL-3251A](#) [LTL-4262N](#) [LTL-5234](#) [LTL87HTBK](#) [LTD-87HD4B](#) [7383/V7C3-BSTA-L/PR3/MS](#) [G22041431007J2C000](#) [HLMP-AG64-X10ZZ](#) [HLMP-EG1A-Z10DV](#) [HLMP-EL3B-WXKDD](#) [HLMP-HB74-UVBDD](#) [HLMP-HG65-VY0DD](#) [HLMP-HM74-34CDD](#) [HLMP-HM75-34CDD](#) [1L0532V23G0TD001](#) [NSPW500CS](#) [C4SMA-BGF-CQ34Q3C2](#) [L53GC13](#) [264-7SURTS530-A3](#) [L-C150JRCT](#) [S4SMS-BJF-CQ42QGF2](#) [S4SMS-GJF-CW12QMF2](#) [LD CQDP-1U3U-W5-1-K](#) [LNX998CKBDA](#) [LO566UHR3-70G-A3](#) [SLA560WBD2PT3](#) [LP379PPG1C0G0300001](#) [SLR-322MCT32](#) [SLR-342DUT32](#) [SLR-342MC3F](#) [SLR343BC7TT32](#) [SLR343BCTT32](#) [SLX-LX3044GD](#) [SLX-LX3044ID](#) [SLX-LX3044YD](#) [SNW-LX504SRC/4](#) [1.90690.3330000](#) [SSL-LX20483ID](#) [SSL-LX3034YD](#) [SSL-LX5093LGT-11](#) [SSL-LX5093PGC](#) [SSL-LX5093SRC/F](#) [SSL-LX5093SYT](#) [SSL-LX5099SRSGC-CA](#) [SSL-LX509E3SIT](#) [SSL-LX509FT3ID](#)