

# High Performance 2A and 3A Linear Regulators

## ISL80102, ISL80103

The [ISL80102](#) and [ISL80103](#) are low voltage, high-current, single output LDOs specified for 2A and 3A output current, respectively. These LDOs operate from the input voltages of 2.2V to 6V and are capable of providing the output voltages of 0.8V to 5.5V on the adjustable  $V_{OUT}$  versions. Other custom voltage options available upon request.

For applications that demand inrush current less than the current limit, an external capacitor on the soft-start pin provides adjustment. The ENABLE feature allows the part to be placed into a low quiescent current shutdown mode. A submicron BiCMOS process is utilized for this product family to deliver the best-in-class analog performance and overall value.

These CMOS (LDOs) will consume significantly lower quiescent current as a function of load over bipolar LDOs, which translates into higher efficiency and the ability to consider packages with smaller footprints. The quiescent current has been modestly compromised to enable a leading class fast load transient response, and hence a lower total AC regulation band for an LDO in this category.

## Features

- Stable with ceramic capacitors ([Note 11](#))
- 2A and 3A output current ratings
- 2.2V to 6V input voltage range
- $\pm 1.8\%$   $V_{OUT}$  accuracy guaranteed over line, load and  $T_J = -40^\circ\text{C}$  to  $+125^\circ\text{C}$
- Very low 120mV dropout voltage at 3A (ISL80103)
- Very fast transient response
- Excellent 62dB PSRR
- $49\mu\text{V}_{\text{RMS}}$  output noise
- Power-good output
- Adjustable inrush current limiting
- Short-circuit and over-temperature protection
- Available in a 10 Ld DFN

## Applications

- Servers
- Telecommunications and networking
- Medical equipment
- Instrumentation systems
- Routers and switchers

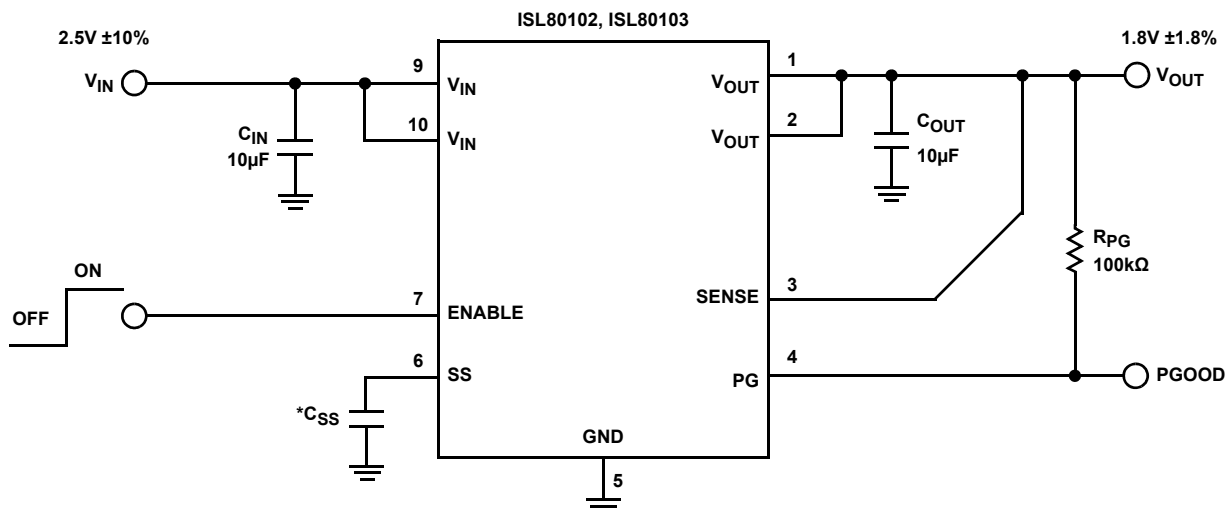

\* $C_{SS}$  is optional, (see [Note 12 on page 5](#)).

FIGURE 1. TYPICAL APPLICATION FOR FIXED OUTPUT VOLTAGE VERSION

# ISL80102, ISL80103

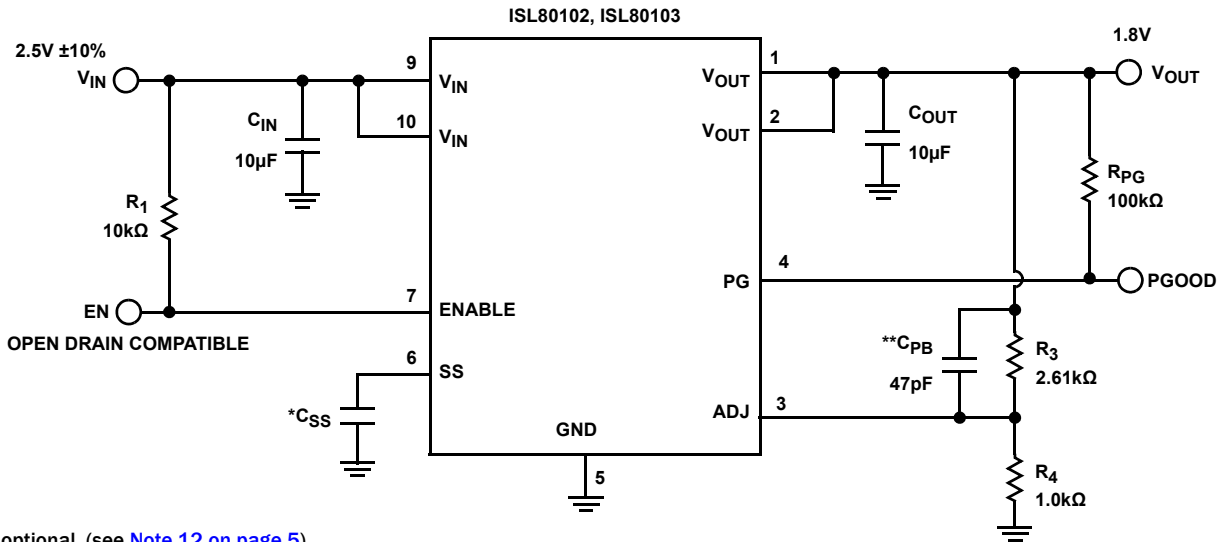

\*C<sub>SS</sub> is optional, (see [Note 12 on page 5](#)).

\*\*C<sub>PB</sub> is optional. See [“Functional Description” on page 12](#) for more information.

FIGURE 2. TYPICAL APPLICATION DIAGRAM FOR ADJUSTABLE OUTPUT VOLTAGE VERSION

TABLE 1. COMPONENTS VALUE SELECTION

V <sub>OUT</sub> (V)	R <sub>TOP</sub> (kΩ)	R <sub>BOTTOM</sub> (Ω)	C <sub>PB</sub> (pF)	C <sub>OUT</sub> (μF)
5.0	2.61	287	47	10
3.3	2.61	464	47	10
2.5	2.61	649	47	10
1.8 ( <a href="#">Note 1</a> )	2.61	1.0k	47	10
1.8 ( <a href="#">Note 1</a> )	2.61	1.0k	82	22
1.5	2.61	1.3k	82	22
1.2	2.61	1.87k	150	47
1.0	2.61	2.61k	150	47
0.8	2.61	4.32k	150	47

**NOTE:**

1. Either option could be used depending on cost/performance requirements

## Pin Configuration

ISL80102, ISL80103  
(10 LD 3x3 DFN)  
TOP VIEW

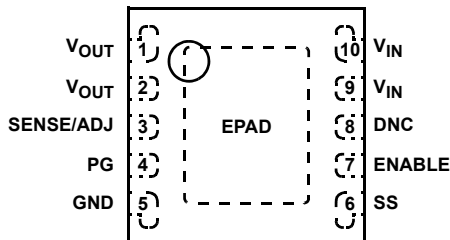

## Pin Descriptions

PIN NUMBER	PIN NAME	DESCRIPTION
1, 2	V <sub>OUT</sub>	Output voltage pin
3	SENSE/ADJ	Remote voltage sense for internally fixed V <sub>OUT</sub> options. ADJ pin for externally set V <sub>OUT</sub> .
4	PG	V <sub>OUT</sub> in regulation signal. Logic low defines when V <sub>OUT</sub> is not in regulation. Must be grounded if not used.
5	GND	GND pin
6	SS	External cap adjusts inrush current. Leave this pin open if not used.
7	ENABLE	V <sub>IN</sub> independent chip enable. TTL and CMOS compatible.
8	DNC	Do not connect this pin to ground or supply. Leave floating.
9, 10	V <sub>IN</sub>	Input supply pin
	EPAD	EPAD must be connected to copper plane with as many vias as possible for proper electrical and optimal thermal performance.

# ISL80102, ISL80103

## Block Diagram

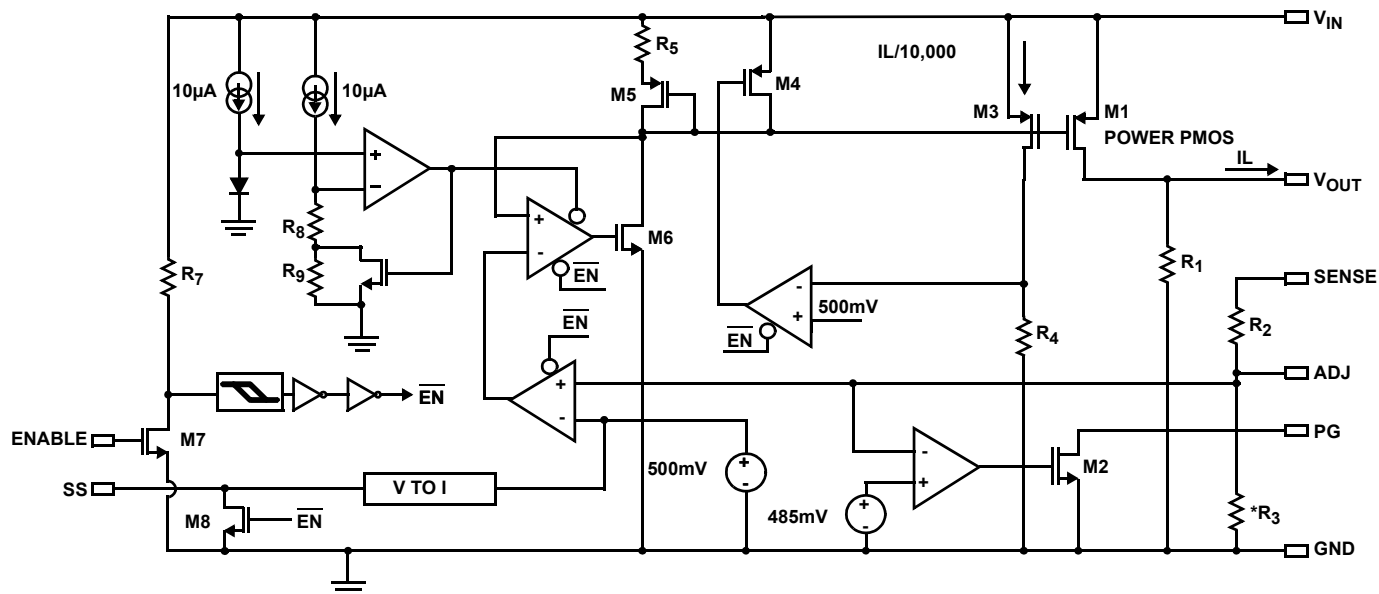

\*R<sub>3</sub> is open for ADJ versions.

FIGURE 3. BLOCK DIAGRAM

## Ordering Information

PART NUMBER (Notes 4, 5)	PART MARKING	V <sub>OUT</sub> VOLTAGE	TEMP. RANGE (°C)	PACKAGE (RoHS COMPLIANT)	PKG DWG. #
ISL80102IRAJZ (Note 2)	DZJA	ADJ	-40 to +125	10 Ld 3x3 DFN	L10.3x3
ISL80102IR18Z (Note 3) (No longer available, recommended replacement: ISL80102IRAJZ)	DZNA	1.8V	-40 to +125	10 Ld 3x3 DFN	L10.3x3
ISL80102IR25Z (Note 3) (No longer available, recommended replacement: ISL80102IRAJZ)	DZPA	2.5V	-40 to +125	10 Ld 3x3 DFN	L10.3x3
ISL80103IRAJZ (Note 2)	DZAA	ADJ	-40 to +125	10 Ld 3x3 DFN	L10.3x3
ISL80103IR18Z (Note 3) (No longer available, recommended replacement: ISL80103IRAJZ)	DZEA	1.8V	-40 to +125	10 Ld 3x3 DFN	L10.3x3
ISL80103IR25Z (Note 3) (No longer available, recommended replacement: ISL80103IRAJZ)	DZFA	2.5V	-40 to +125	10 Ld 3x3 DFN	L10.3x3
ISL80102EVAL2Z	Evaluation Board				
ISL80103EVAL2Z	Evaluation Board				

### NOTES:

- Add "-T" suffix for 6k unit, "-TK" suffix for 1k unit or "-T7A" suffix for 250 unit Tape and Reel options. Please refer to [TB347](#) for details on reel specifications.
- Add "-T" suffix for 6k unit or "-TK" suffix for 1k unit Tape and Reel options. Please refer to [TB347](#) for details on reel specifications.
- These Intersil Pb-free plastic packaged products employ special Pb-free material sets, molding compounds/die attach materials, and 100% matte tin plate plus anneal (e3 termination finish, which is RoHS compliant and compatible with both SnPb and Pb-free soldering operations). Intersil Pb-free products are MSL classified at Pb-free peak reflow temperatures that meet or exceed the Pb-free requirements of IPC/JEDEC J STD-020.
- For Moisture Sensitivity Level (MSL), please see device information page for [ISL80102](#), [ISL80103](#). For more information on MSL please see tech brief [TB363](#).

# ISL80102, ISL80103

## Absolute Maximum Ratings [\(Note 8\)](#)

$V_{IN}$ Relative to GND	-0.3V to +6.5V
$V_{OUT}$ Relative to GND	-0.3V to +6.5V
PG, ENABLE, SENSE/ADJ, SS, Relative to GND	-0.3V to +6.5V
ESD Rating	
Human Body Model (Tested per JESD22 A114F)	2.2kV
Charge Device Model (Tested per JESD22-C101C)	1kV
Latch-up (Tested per JESD78C, Class 2, Level A)	$\pm 100$ mA at +85°C

## Thermal Information

Thermal Resistance (Typical)	$\theta_{JA}$ (°C/W)	$\theta_{JC}$ (°C/W)
10 Ld 3x3 DFN Package <a href="#">(Notes 6, 7)</a>	45	4
Maximum Junction Temperature (Plastic Package)	+150°C	
Storage Temperature Range	-65°C to +150°C	
Pb-Free Reflow Profile	see <a href="#">TB493</a>	

## Recommended Operating Conditions

Junction Temperature Range ( $T_J$ )	-40°C to +125°C
$V_{IN}$ Relative to GND	2.2V to 6V
$V_{OUT}$ Range	800mV to 5.5V
PG, ENABLE, SENSE/ADJ, SS Relative to GND	0V to 6V
PG Sink Current	10mA

**CAUTION:** Do not operate at or near the maximum ratings listed for extended periods of time. Exposure to such conditions may adversely impact product reliability and result in failures not covered by warranty.

### NOTES:

- $\theta_{JA}$  is measured in free air with the component mounted on a high effective thermal conductivity test board with “direct attach” features. See Tech Brief [TB379](#).
- For  $\theta_{JC}$ , the “case temp” location is the center of the exposed metal pad on the package underside.
- ABS max voltage rating is defined as the voltage applied for a lifetime average duty cycle above 6V of 1%.

## Electrical Specifications

Unless otherwise noted, all parameters are established over the following specified conditions: 2.2V <  $V_{IN}$  < 6V,  $V_{OUT}$  = 0.5V,  $T_J$  = +25°C,  $I_{LOAD}$  = 0A. Applications must follow thermal guidelines of the package to determine worst case junction temperature. Please refer to [“Functional Description” on page 12](#) and Tech Brief [TB379](#). **Boldface limits apply across the operating temperature range, -40°C to +125°C.** Pulse load techniques used by ATE to ensure  $T_J = T_A$  defines established limits.

PARAMETER	SYMBOL	TEST CONDITIONS	MIN <a href="#">(Note 9)</a>	TYP	MAX <a href="#">(Note 9)</a>	UNIT
<b>DC CHARACTERISTICS</b>						
DC Output Voltage Accuracy	$V_{OUT}$	$V_{OUT}$ options: 1.8V 2.2V < $V_{IN}$ < 6V; $I_{LOAD}$ = 0A		0.5		%
		$V_{OUT}$ options: 1.8V 2.2V < $V_{IN}$ < 6V; 0A < $I_{LOAD}$ < 3A	<b>-1.8</b>		<b>1.8</b>	%
		$V_{OUT}$ options: 2.5V 6V < $V_{IN}$ < 6V; $I_{LOAD}$ = 0A		0.5		%
		$V_{OUT}$ options: 2.5V 6V < $V_{IN}$ < 6V; 0A < $I_{LOAD}$ < full load	<b>-1.8</b>		<b>-1.8</b>	%
Feedback Pin (ADJ Version)	$V_{ADJ}$	0A < $I_{LOAD}$ < full load	<b>491</b>	500	<b>509</b>	mV
DC Input Line Regulation	$(V_{OUT}$ Low Line - $V_{OUT}$ High Line) / $V_{OUT}$ Low Line	2.2V < $V_{IN}$ < 3.6V, $V_{OUT}$ = 1.8V	<b>-0.4</b>	0.1	<b>0.4</b>	%
		2.9V < $V_{IN}$ < 6V, $V_{OUT}$ = 2.5V	<b>-0.8</b>	0.1	<b>0.8</b>	%
DC Output Load Regulation	$(V_{OUT}$ No Load - $V_{OUT}$ High Load) / $V_{OUT}$ No Load	ISL80103, 0A < $I_{LOAD}$ < 3A, 2.9V < $V_{IN}$ < 6V; $V_{OUT}$ = 2.5V for adjustable version. $V_{OUT}$ = 1.8V and 2.5V for fixed version.	<b>-0.8</b>	-0.2	<b>0.8</b>	%
		ISL80102, 0A < $I_{LOAD}$ < 2A 2.9V < $V_{IN}$ < 6V; $V_{OUT}$ = 2.5V for adjustable version. $V_{OUT}$ = 1.8V and 2.5V for fixed version.	<b>-0.6</b>	-0.2	<b>0.6</b>	%
Feedback Input Current		$V_{ADJ}$ = 0.5V		0.01	<b>1</b>	$\mu$ A
Ground Pin Current	$I_Q$	$I_{LOAD}$ = 0A, $V_{OUT}$ + 0.4V < $V_{IN}$ < 6V for all options. $V_{OUT}$ = 2.5V for adjustable option.		7.5	<b>9</b>	mA
		$I_{LOAD}$ = 3A, $V_{OUT}$ + 0.4V < $V_{IN}$ < 6V for all options. $V_{OUT}$ = 2.5V for adjustable option.		8.5	<b>12</b>	mA

# ISL80102, ISL80103

**Electrical Specifications** Unless otherwise noted, all parameters are established over the following specified conditions:  $2.2V < V_{IN} < 6V$ ,  $V_{OUT} = 0.5V$ ,  $T_J = +25^\circ C$ ,  $I_{LOAD} = 0A$ . Applications must follow thermal guidelines of the package to determine worst case junction temperature. Please refer to [“Functional Description” on page 12](#) and Tech Brief [TB379](#). **Boldface limits apply across the operating temperature range,  $-40^\circ C$  to  $+125^\circ C$ .** Pulse load techniques used by ATE to ensure  $T_J = T_A$  defines established limits. (Continued)

PARAMETER	SYMBOL	TEST CONDITIONS	MIN (Note 9)	TYP	MAX (Note 9)	UNIT
Ground Pin Current in Shutdown	$I_{SHDN}$	$EN = 0V, V_{IN} = 5V$		0.4		$\mu A$
		$EN = 0V, V_{IN} = 6V$		3.3	<b>16.0</b>	$\mu A$
Dropout Voltage (Note 10)	$V_{DO}$	ISL80103, $I_{LOAD} = 3A, V_{OUT} = 2.5V$		120	<b>185</b>	mV
		ISL80102, $I_{LOAD} = 2A, V_{OUT} = 2.5V$		81	<b>125</b>	mV
		ISL80103, $I_{LOAD} = 3A, V_{OUT} = 5.5V$		120	<b>244</b>	mV
		ISL80102, $I_{LOAD} = 2A, V_{OUT} = 5.5V$		60	<b>121</b>	mV
Output Short-Circuit Current (3A Version)	ISC	ISL80103, $V_{OUT} = 0V$		5.0		A
Output Short-Circuit Current (2A Version)		ISL80102, $V_{OUT} = 0V$		2.8		A
Thermal Shutdown Temperature	TSD			160		$^\circ C$
Thermal Shutdown Hysteresis	TSDn			15		$^\circ C$
<b>AC CHARACTERISTICS</b>						
Input Supply Ripple Rejection	PSRR	$f = 1kHz, I_{LOAD} = 1A; V_{IN} = 2.2V$		55		dB
		$f = 120Hz, I_{LOAD} = 1A; V_{IN} = 2.2V$		62		dB
Output Noise Voltage		$V_{IN} = 2.2V, V_{OUT} = 1.8V, I_{LOAD} = 3A,$ $BW = 100Hz < f < 100kHz$		49		$\mu V_{RMS}$
<b>ENABLE PIN CHARACTERISTICS</b>						
Turn-On Threshold	$V_{EN(HIGH)}$	$2.9V < V_{IN} < 6V$ for 2.5V for fixed output option. $2.2V < V_{IN} < 6V$ for adjustable and 1.8V	<b>0.616</b>	0.800	<b>0.950</b>	V
Turn-Off Threshold	$V_{EN(LOW)}$	$2.9V < V_{IN} < 6V$ for 2.5V fixed output option. $2.2V < V_{IN} < 6V$ for adjustable and 1.8V	<b>0.463</b>	0.600		V
Hysteresis	$V_{EN(HYS)}$	$2.9V < V_{IN} < 6V$ for 2.5V fixed output option. $2.2V < V_{IN} < 6V$ for adjustable and 1.8V		135		mV
Enable Pin Turn-On Delay	$t_{EN}$	$C_{OUT} = 10\mu F, I_{LOAD} = 1A$		150		$\mu s$
Enable Pin Leakage Current		$V_{IN} = 6V, EN = 3V$			<b>1</b>	$\mu A$
<b>SOFT-START CHARACTERISTICS</b>						
Reset Pull-Down Resistance	RPD			323		$\Omega$
Soft-Start Charge Current	ICHG		<b>-7.0</b>	-4.5	<b>-2.0</b>	$\mu A$
<b>PG PIN CHARACTERISTICS</b>						
$V_{OUT}$ PG Flag Threshold			<b>75</b>	84	<b>92</b>	$\%V_{OUT}$
$V_{OUT}$ PG Flag Hysteresis				4		%
PG Flag Low Voltage		$I_{SINK} = 500\mu A$		47	<b>100</b>	mV
PG Flag Leakage Current		$V_{IN} = 6V, PG = 6V$		0.05	<b>1</b>	$\mu A$

## NOTES:

- Compliance to datasheet limits is assured by one or more methods: production test, characterization and/or design.
- Dropout is defined by the difference in supply  $V_{IN}$  and  $V_{OUT}$  when the supply produces a 2% drop in  $V_{OUT}$  from its nominal value.
- Minimum cap of  $10\mu F$  X5R/X7R on  $V_{IN}$  and  $V_{OUT}$  required for stability.
- If the current limit for inrush current is acceptable in application, do not use this feature (leave SS pin open). Used only when large bulk capacitance required on  $V_{OUT}$  for application.

# ISL80102, ISL80103

## Typical Operating Performance

$I_L = 0A$ .

Unless otherwise noted:  $V_{IN} = 2.2V$ ,  $V_{OUT} = 1.8V$ ,  $C_{IN} = C_{OUT} = 10\mu F$ ,  $T_J = +25^\circ C$ ,

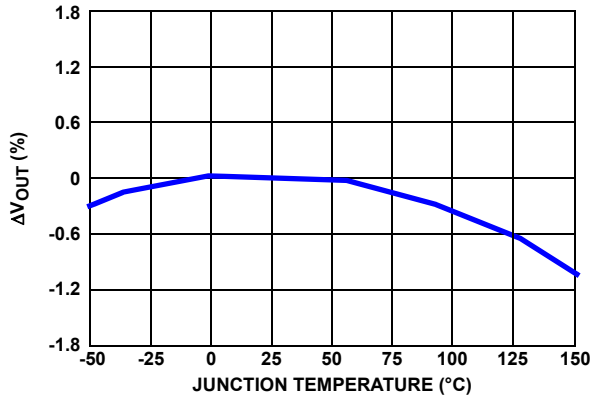

FIGURE 4.  $\Delta V_{OUT}$  vs TEMPERATURE

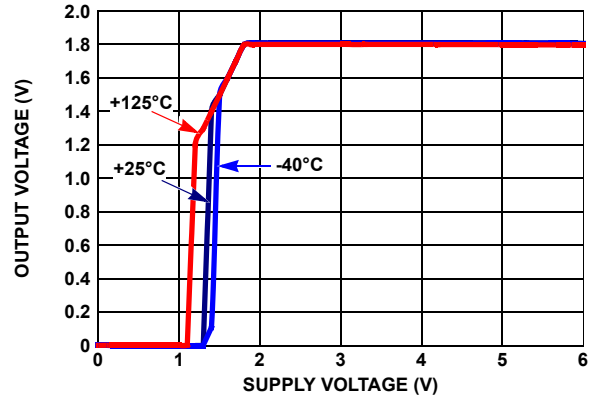

FIGURE 5. OUTPUT VOLTAGE vs SUPPLY VOLTAGE

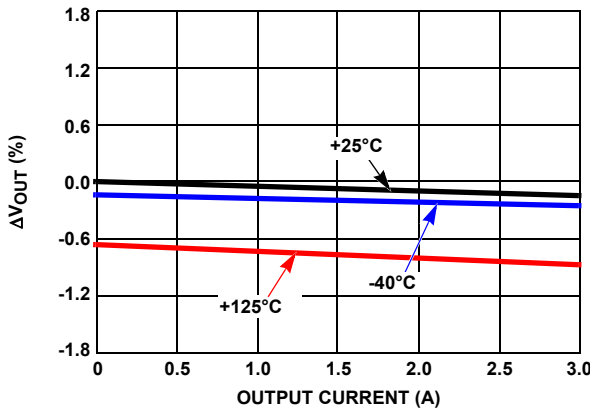

FIGURE 6.  $\Delta V_{OUT}$  vs OUTPUT CURRENT

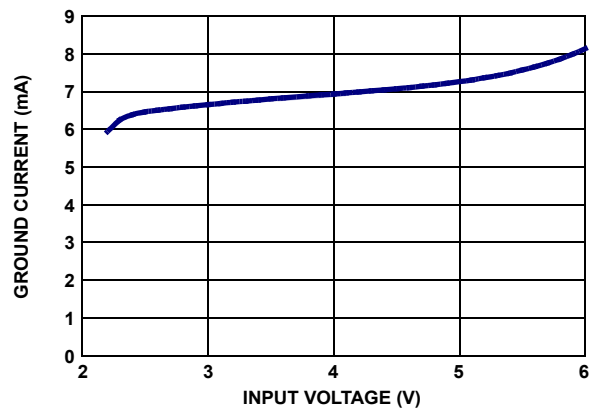

FIGURE 7. GROUND CURRENT vs SUPPLY VOLTAGE

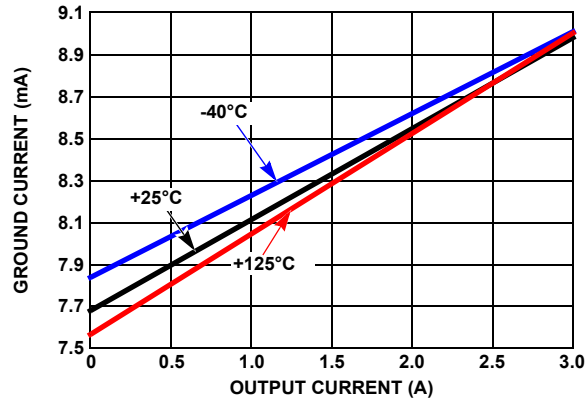

FIGURE 8. GROUND CURRENT vs OUTPUT CURRENT

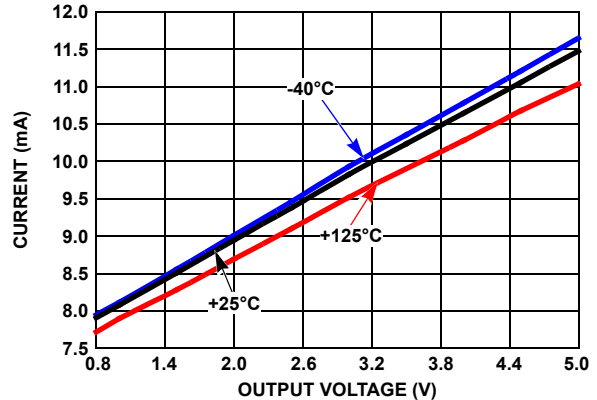

FIGURE 9. GROUND CURRENT vs OUTPUT VOLTAGE ( $V_{IN} = V_{OUT} + V_{DO}$ )

# ISL80102, ISL80103

## Typical Operating Performance

Unless otherwise noted:  $V_{IN} = 2.2V$ ,  $V_{OUT} = 1.8V$ ,  $C_{IN} = C_{OUT} = 10\mu F$ ,  $T_J = +25^\circ C$ ,  $I_L = 0A$ . (Continued)

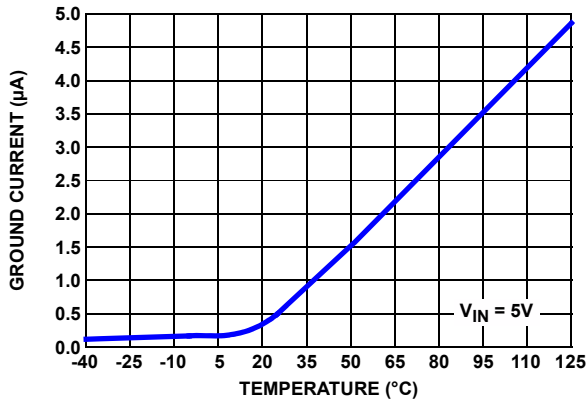

FIGURE 10. GROUND CURRENT IN SHUTDOWN vs TEMPERATURE

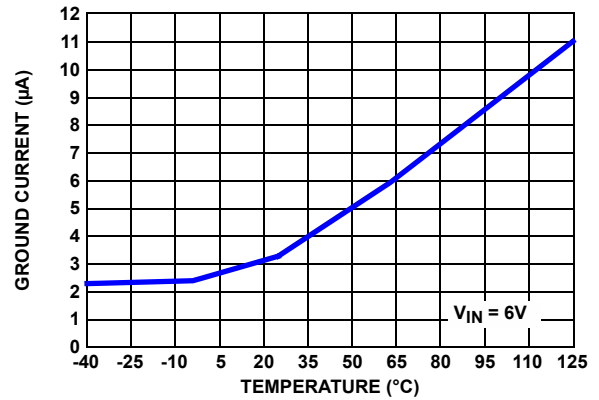

FIGURE 11. GROUND CURRENT IN SHUTDOWN vs TEMPERATURE

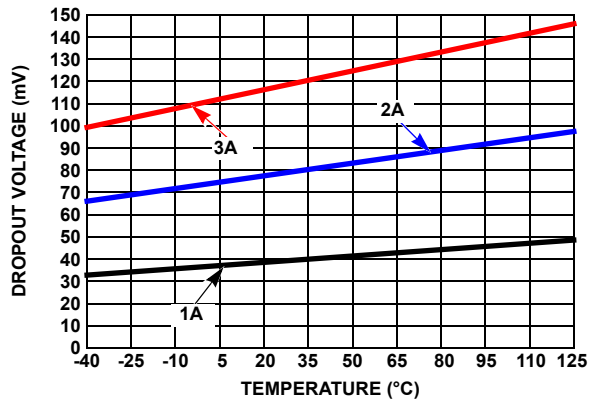

FIGURE 12. DROPOUT VOLTAGE vs TEMPERATURE

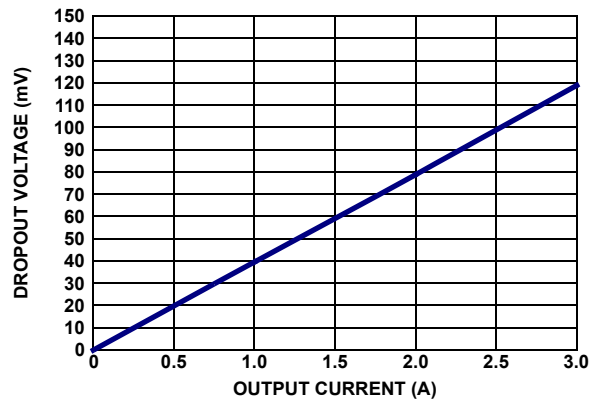

FIGURE 13. DROPOUT VOLTAGE vs OUTPUT CURRENT

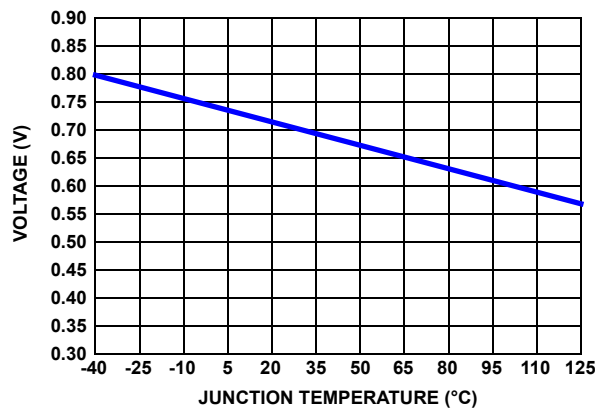

FIGURE 14. ENABLE THRESHOLD VOLTAGE vs TEMPERATURE

# ISL80102, ISL80103

## Typical Operating Performance

$I_L = 0A$ . (Continued)

Unless otherwise noted:  $V_{IN} = 2.2V$ ,  $V_{OUT} = 1.8V$ ,  $C_{IN} = C_{OUT} = 10\mu F$ ,  $T_J = +25^\circ C$ ,

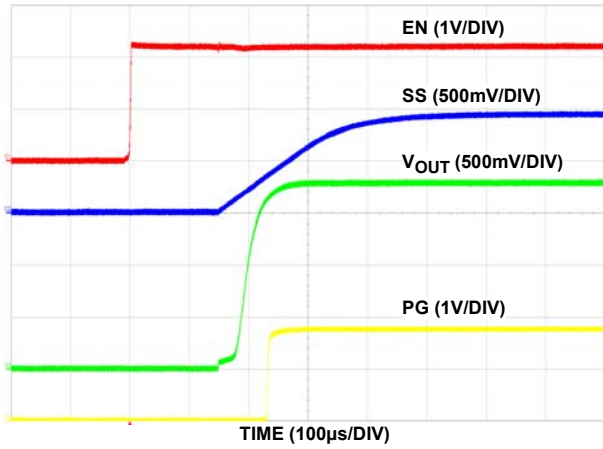

FIGURE 15. ENABLE START-UP SS CAP 1nF

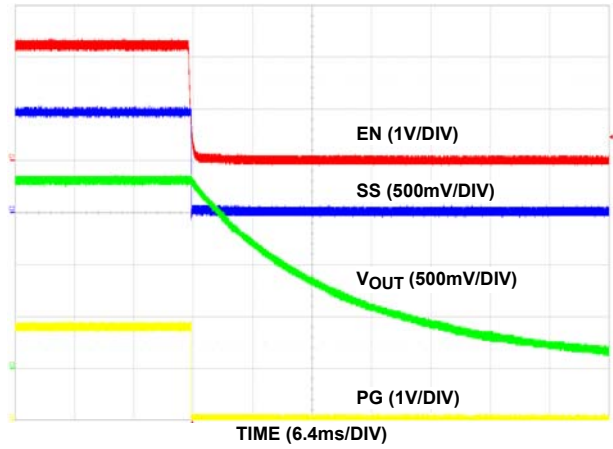

FIGURE 16. ENABLE SHUTDOWN SS CAP 1nF

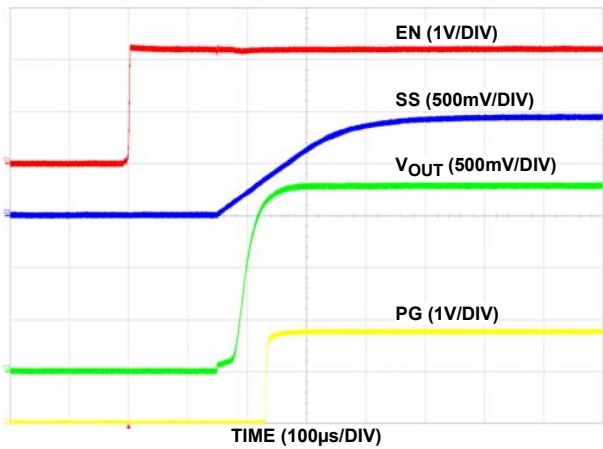

FIGURE 17. ENABLE START-UP SS CAP 100nF

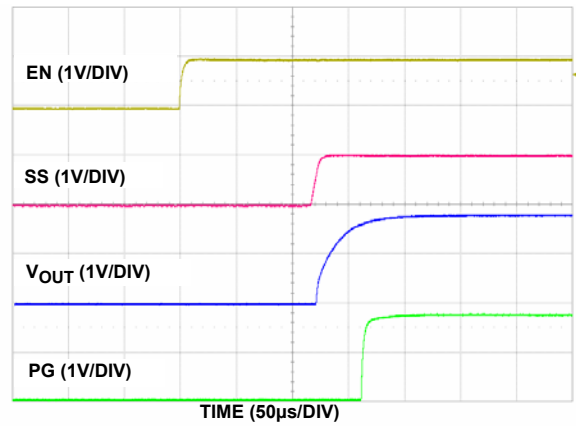

FIGURE 18. ENABLE START-UP (NO SS CAP)

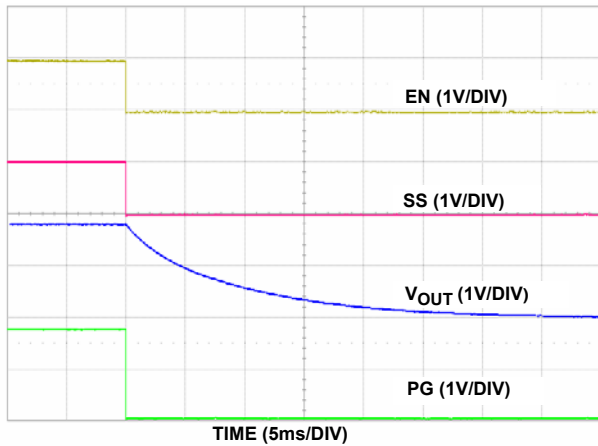

FIGURE 19. ENABLE SHUTDOWN (NO SS CAP)

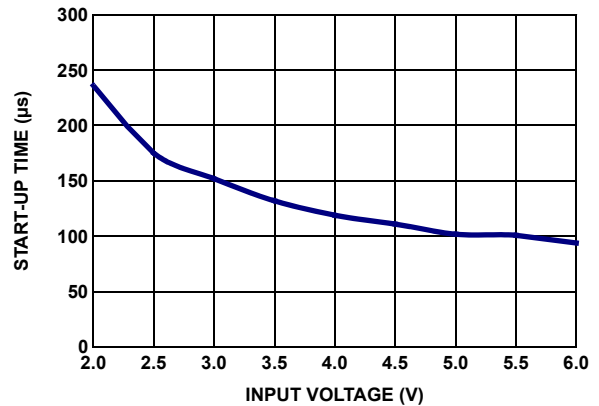

FIGURE 20. START-UP TIME vs SUPPLY VOLTAGE



# ISL80102, ISL80103

## Typical Operating Performance

$I_L = 0A$ . (Continued)

Unless otherwise noted:  $V_{IN} = 2.2V$ ,  $V_{OUT} = 1.8V$ ,  $C_{IN} = C_{OUT} = 10\mu F$ ,  $T_J = +25^\circ C$ ,

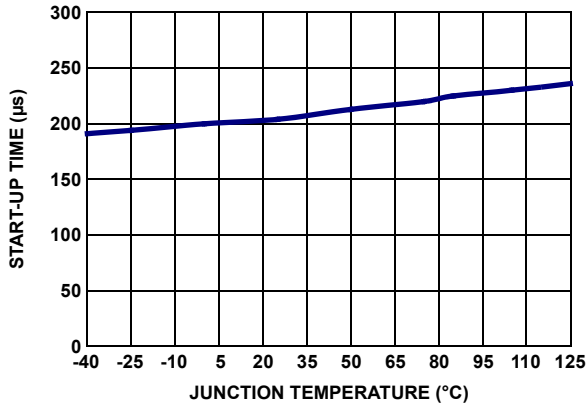

FIGURE 21. START-UP TIME vs TEMPERATURE

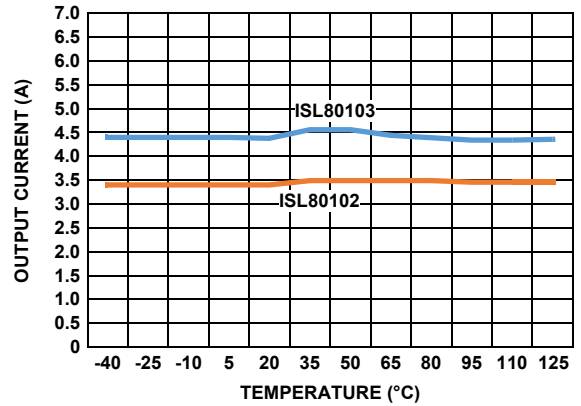

FIGURE 22. CURRENT LIMIT vs TEMPERATURE

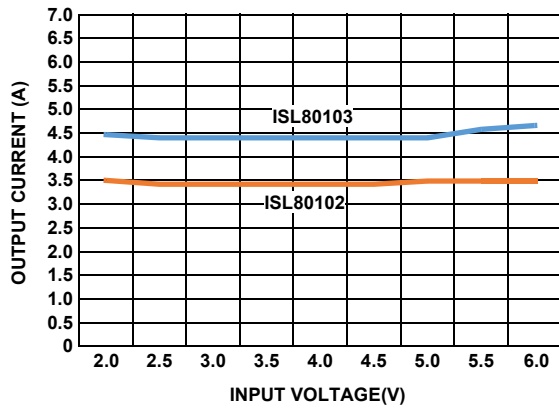

FIGURE 23. CURRENT LIMIT vs SUPPLY VOLTAGE

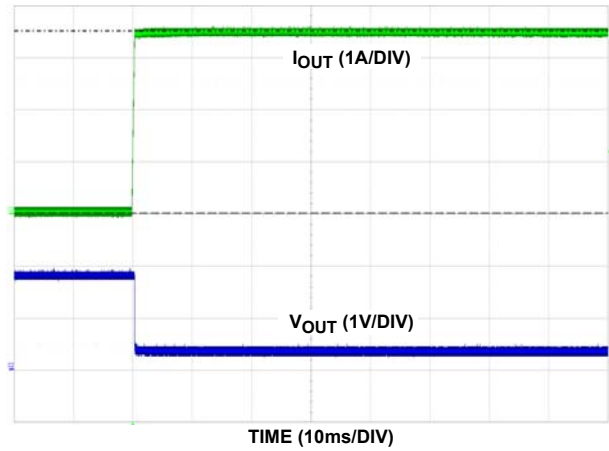

FIGURE 24. CURRENT LIMIT RESPONSE (ISL80102)

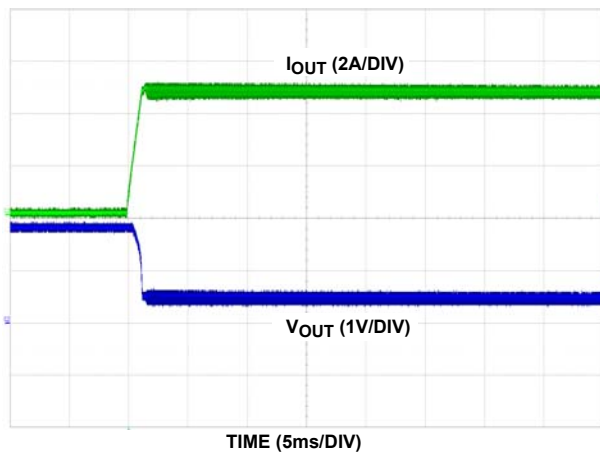

FIGURE 25. CURRENT LIMIT RESPONSE (ISL80103)

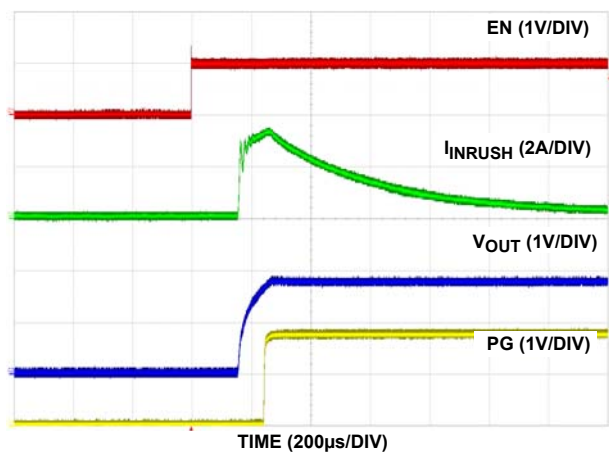

FIGURE 26. INRUSH CURRENT WITH NO SOFT-START CAPACITOR,  $C_{OUT} = 1000\mu F$

# ISL80102, ISL80103

## Typical Operating Performance

$I_L = 0A$ . (Continued)

Unless otherwise noted:  $V_{IN} = 2.2V$ ,  $V_{OUT} = 1.8V$ ,  $C_{IN} = C_{OUT} = 10\mu F$ ,  $T_J = +25^\circ C$ ,

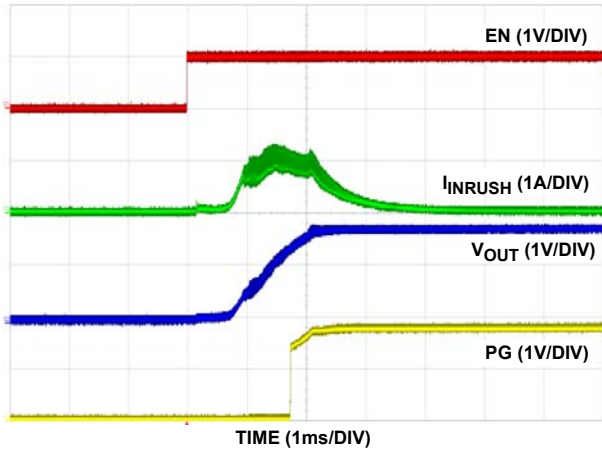

FIGURE 27. INRUSH WITH 22nF SOFT-START CAPACITOR,  $C_{OUT} = 1000\mu F$

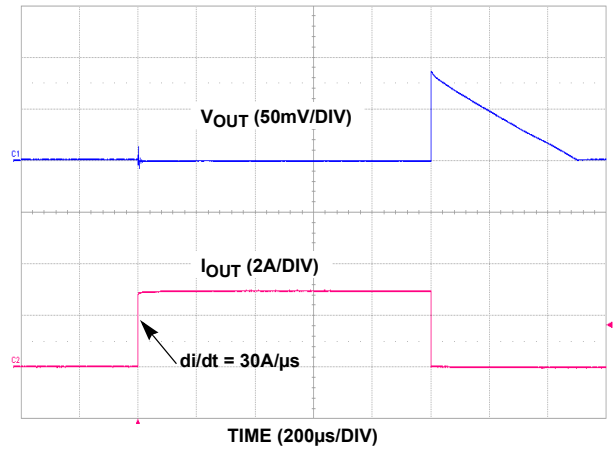

FIGURE 28. LOAD TRANSIENT 0A TO 3A,  $C_{OUT} = 10\mu F$  CERAMIC

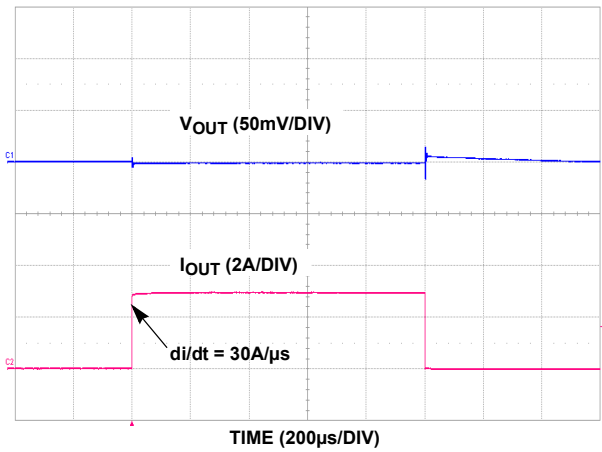

FIGURE 29. LOAD TRANSIENT 0A TO 3A,  $C_{OUT} = 10\mu F$  CERAMIC + 100µF OSCON

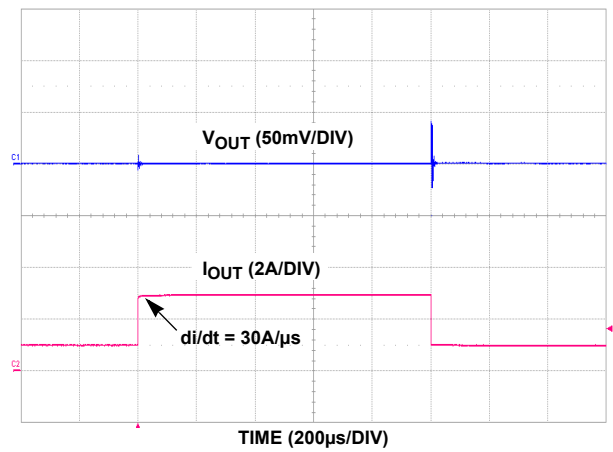

FIGURE 30. LOAD TRANSIENT 1A TO 3A,  $C_{OUT} = 10\mu F$  CERAMIC

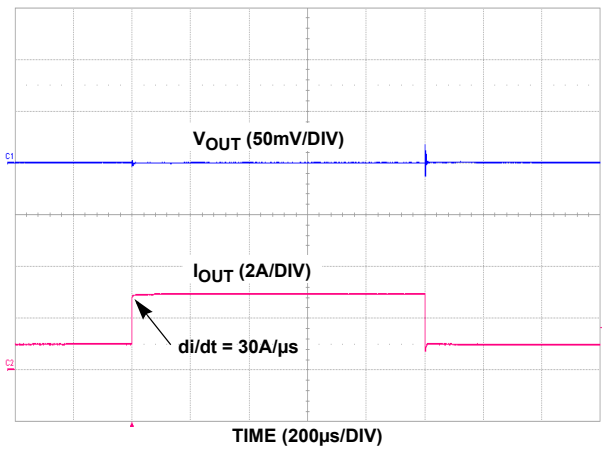

FIGURE 31. LOAD TRANSIENT 1A TO 3A,  $C_{OUT} = 10\mu F$  CERAMIC + 100µF OSCON

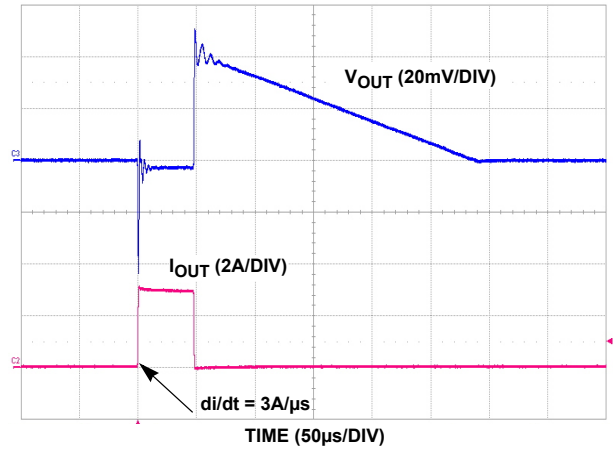

FIGURE 32. LOAD TRANSIENT 0A TO 3A,  $C_{OUT} = 10\mu F$  CERAMIC, NO  $C_{PB}$  (ADJ VERSION)

# ISL80102, ISL80103

## Typical Operating Performance

$I_L = 0A$ . (Continued)

Unless otherwise noted:  $V_{IN} = 2.2V$ ,  $V_{OUT} = 1.8V$ ,  $C_{IN} = C_{OUT} = 10\mu F$ ,  $T_J = +25^\circ C$ ,

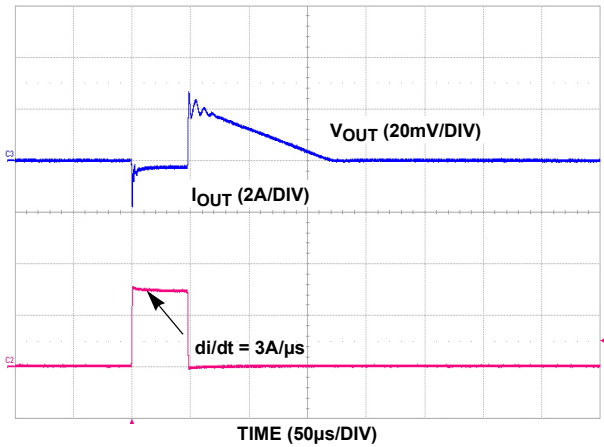

FIGURE 33. LOAD TRANSIENT 0A TO 3A,  $C_{OUT} = 10\mu F$  CERAMIC,  $C_{PB} = 1500pF$  (ADJ VERSION)

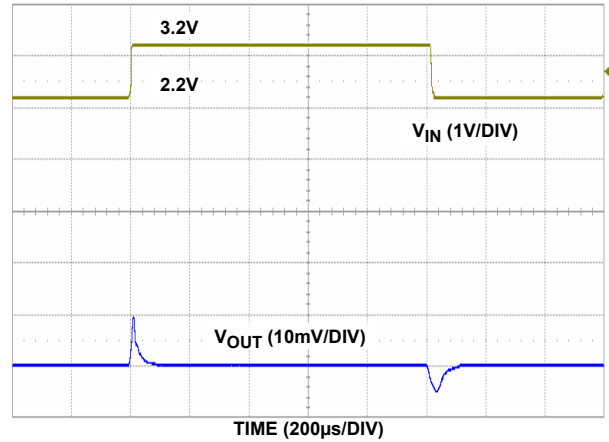

FIGURE 34. LINE TRANSIENT

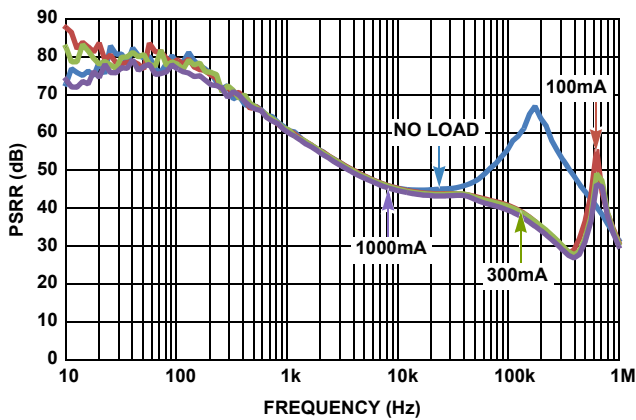

FIGURE 35. PSRR vs FREQUENCY FOR  $V_{OUT} = 1.0V$ ,  $V_{IN} = 2.5V$ ;  $C_{OUT} = 47\mu F$ ,  $C_{PB} = 150pF$

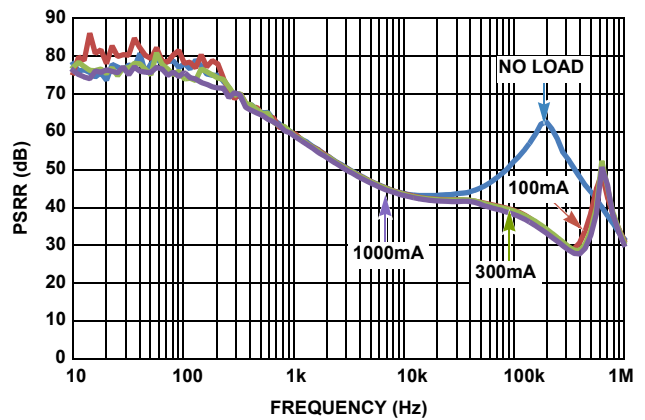

FIGURE 36. PSRR vs FREQUENCY FOR  $V_{OUT} = 1.2V$ ;  $V_{IN} = 2.5V$ ;  $C_{OUT} = 47\mu F$ ,  $C_{PB} = 150pF$

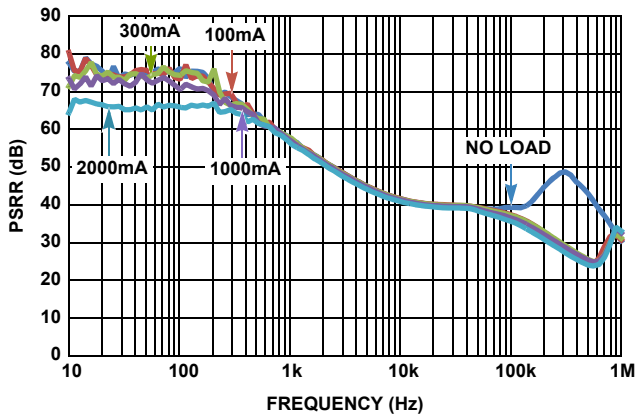

FIGURE 37. PSRR vs FREQUENCY FOR  $V_{OUT} = 1.5V$ ,  $V_{IN} = 2.5V$ ;  $C_{OUT} = 22\mu F$ ,  $C_{PB} = 82pF$

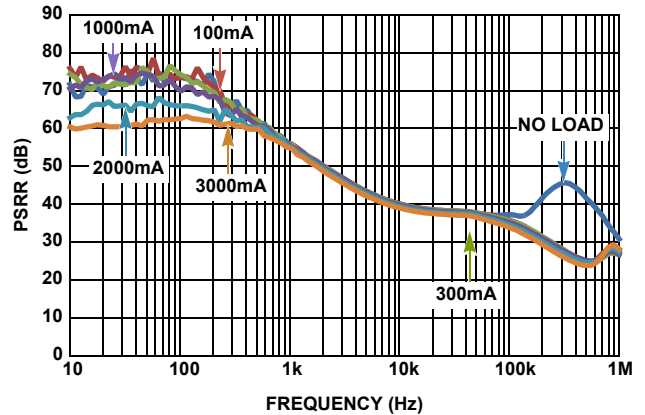

FIGURE 38. PSRR vs FREQUENCY FOR  $V_{OUT} = 1.8V$ ,  $V_{IN} = 2.5V$ ;  $C_{OUT} = 22\mu F$ ,  $C_{PB} = 82pF$

## Typical Operating Performance

$I_L = 0A$ . (Continued)

Unless otherwise noted:  $V_{IN} = 2.2V$ ,  $V_{OUT} = 1.8V$ ,  $C_{IN} = C_{OUT} = 10\mu F$ ,  $T_J = +25^\circ C$ ,

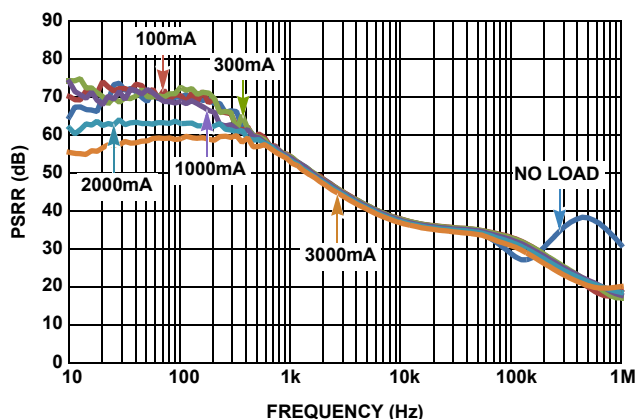

FIGURE 39. PSRR vs FREQUENCY FOR  $V_{OUT} = 2.5V$ ,  $V_{IN} = 3.3V$ ;  
 $C_{OUT} = 10\mu F$ ,  $C_{PB} = 47pF$

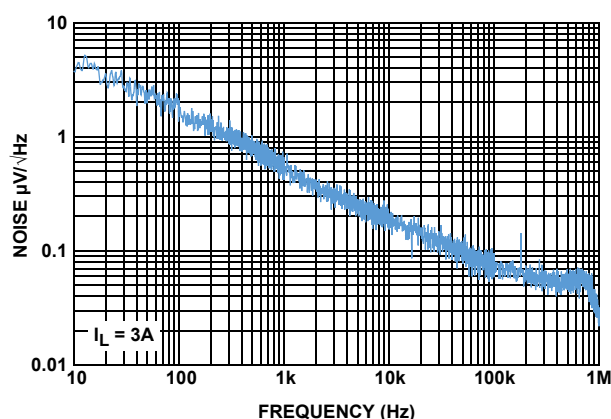

FIGURE 40. SPECTRAL NOISE DENSITY vs FREQUENCY

## Functional Description

### Input Voltage Requirements

Despite other output voltages offered, this family of LDOs is optimized for a true 2.5V to 1.8V conversion where the input supply can have a tolerance of as much as  $\pm 10\%$  for conditions noted in the “Electrical Specifications” table on [page 4](#). Minimum guaranteed input voltage is 2.2V, however, due to the nature of an LDO,  $V_{IN}$  must be some margin higher than the output voltage plus dropout at the maximum rated current of the application if active filtering (PSRR) is expected from  $V_{IN}$  to  $V_{OUT}$ . The dropout spec of this family of LDOs has been generously specified in order to allow applications to design for a level of efficiency that can accommodate the smaller outline package.

### Enable Operation

The Enable turn-on threshold is typically 800mV with a hysteresis of 135mV. An internal pull-up or pull-down resistor is available upon request. As a result, this pin must not be left floating. This pin must be tied to  $V_{IN}$  if it is not used. A 1k $\Omega$  to 10k $\Omega$  pull-up resistor is required for applications that use open collector or open drain outputs to control the Enable pin. The Enable pin may be connected directly to  $V_{IN}$  for applications that are always on.

### Power-Good Operation

Applications not using this feature must connect this pin to ground. The PGOOD flag is an open-drain NMOS that can sink up to 10mA during a fault condition. The PGOOD pin requires an external pull-up resistor, which is typically connected to the  $V_{OUT}$  pin. The PGOOD pin should not be pulled up to a voltage source greater than  $V_{IN}$ . The PGOOD fault can be caused by the output voltage going below 84% of the nominal output voltage, or the current limit fault, or low input voltage. The PGOOD does not function during thermal shutdown.

### Soft-Start Operation (Optional)

If the current limit for inrush current is acceptable in the application, do not use this feature (leave SS pin open). The soft-start circuit controls the rate at which the output voltage comes up to regulation at power-up or LDO enable. The external soft-start capacitor always gets discharged to ground pin potential at the beginning of start-up or enabling. After the capacitor discharges, it will immediately begin charging by a constant current source. The discharge rate is the RC time constant of  $R_{PD}$  and  $C_{SS}$ . See [Figures 15](#) through [19](#) in the “Typical Operating Performance Curves” beginning on [page 8](#).  $R_{PD}$  is the ON-resistance of the pull-down MOSFET, M8.  $R_{PD}$  is 323 $\Omega$  typically.

The soft-start feature effectively reduces the inrush current at power-up or LDO enable until  $V_{OUT}$  reaches regulation. The in-rush current can be an issue for applications that require large, external bulk capacitances on  $V_{OUT}$  where high levels of charging current can be seen for a significant period of time. The inrush currents can cause  $V_{IN}$  to drop below minimum which could cause  $V_{OUT}$  to shutdown. [Figure 27](#) shows the relationship between inrush current and  $C_{SS}$  with a  $C_{OUT}$  of 1000 $\mu F$ .

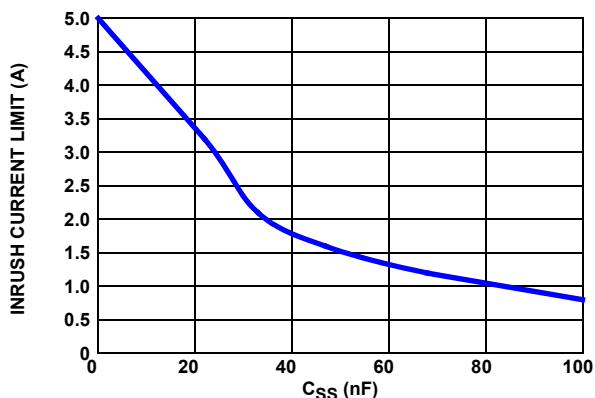

FIGURE 41. INRUSH CURRENT vs SOFT-START CAPACITANCE

## Output Voltage Selection

An external resistor divider is used to scale the output voltage relative to the internal reference voltage. This voltage is then fed back to the error amplifier. The output voltage can be programmed to any level between 0.8V and 5.5V. An external resistor divider,  $R_3$  and  $R_4$ , is used to set the output voltage as shown in [Equation 1](#). The recommended value for  $R_4$  is 500Ω to 1kΩ.  $R_3$  is then chosen according to [Equation 2](#):

$$V_{OUT} = 0.5V \times \left( \frac{R_3}{R_4} + 1 \right) \quad (\text{EQ. 1})$$

$$R_3 = R_4 \times \left( \frac{V_{OUT}}{0.5V} - 1 \right) \quad (\text{EQ. 2})$$

## External Capacitor Requirements

External capacitors are required for proper operation. To ensure optimal performance careful attention must be paid to the layout guidelines and selection of capacitor type and value.

### OUTPUT CAPACITOR

The ISL80102 and ISL80103 applies state-of-the-art internal compensation to keep selection of the output capacitor simple for the customer. Stable operation over full temperature,  $V_{IN}$  range,  $V_{OUT}$  range and load extremes are guaranteed for all ceramic capacitors and values assuming a 10μF X5R/X7R is used for local bypass on  $V_{OUT}$ . This minimum capacitor (see [Table 1 on page 2](#) components value selection) must be connected to  $V_{OUT}$  and Ground pins of the LDO with PCB traces no longer than 0.5cm.

Lower cost Y5V and Z5U type ceramic capacitors are acceptable if the size of the capacitor is larger to compensate for the significantly lower tolerance over X5R/X7R types. Additional capacitors of any value in Ceramic, POSCAP or Alum/Tantalum Electrolytic types may be placed in parallel to improve PSRR at higher frequencies and/or load transient AC output voltage tolerances.

### INPUT CAPACITOR

The minimum input capacitor required for proper operation is 10μF having a ceramic dielectric. This minimum capacitor must be connected to  $V_{IN}$  and ground pins of the LDO with PCB traces no longer than 0.5cm.

### Phase Boost Capacitor (Optional)

The ISL80102 and ISL80103 are designed to be stable with 10μF or larger ceramic capacitor.

Applications using the ADJ versions may see improved performance with the addition of a small ceramic capacitor  $C_{PB}$  as shown in [Figure 2, on page 2](#). The conditions where  $C_{PB}$  may be beneficial are: (1)  $V_{OUT} > 1.5V$ , (2)  $C_{OUT} = 10\mu F$ , and (3) tight AC voltage regulation band.

$C_{PB}$  introduces phase lead with the product of  $R_3$  and  $C_{PB}$  that results in increasing the bandwidth of the LDO. Typical  $R_3 \times C_{PB}$  should be less than 0.4μs (400ns).

## Current Limit Protection

The ISL80102 and ISL80103 family of LDOs incorporates protection against overcurrent due to short, overload condition applied to the output and the inrush current that occurs at start-up. The LDO performs as a constant current source when the output current exceeds the current limit threshold noted in the "Electrical Specifications" table on [page 4](#). If the short or overload condition is removed from  $V_{OUT}$ , then the output returns to normal voltage mode regulation. In the event of an overload condition, the LDO might begin to cycle on and off due to the die temperature exceeding the thermal fault condition.

## Power Dissipation and Thermals

The junction temperature must not exceed the range specified in the "[Recommended Operating Conditions](#)" on [page 4](#). The power dissipation can be calculated by using [Equation 3](#):

$$P_D = (V_{IN} - V_{OUT}) \times I_{OUT} + V_{IN} \times I_{GND} \quad (\text{EQ. 3})$$

The maximum allowable junction temperature,  $T_{J(MAX)}$  and the maximum expected ambient temperature,  $T_{A(MAX)}$  will determine the maximum allowable power dissipation as shown in [Equation 4](#):

$$P_{D(MAX)} = (T_{J(MAX)} - T_A) / \theta_{JA} \quad (\text{EQ. 4})$$

Where  $\theta_{JA}$  is the junction-to-ambient thermal resistance.

For safe operation, please make sure that power dissipation calculated in [Equation 3](#),  $P_D$ , be less than the maximum allowable power dissipation  $P_{D(MAX)}$ .

The DFN package uses the copper area on the PCB as a heatsink. The EPAD of this package must be soldered to the copper plane (GND plane) for heat sinking. [Figure 42](#) shows a curve for the  $\theta_{JA}$  of the DFN package for different copper area sizes.

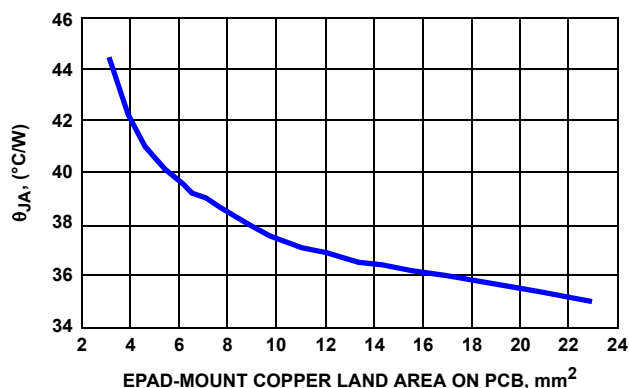

FIGURE 42. 3mmx3mm-10 PIN DFN ON 4-LAYER PCB WITH THERMAL VIAS  $\theta_{JA}$  vs EPAD-MOUNT COPPER LAND AREA ON PCB

## Thermal Fault Protection

In the event the die temperature exceeds typically +160°C, then the output of the LDO will shut down until the die temperature can cool down to typically +145°C. The level of power combined with the thermal impedance of the package (+48°C/W for DFN) will determine if the junction temperature exceeds the thermal shutdown temperature.

# ISL80102, ISL80103

## Revision History

The revision history provided is for informational purposes only and is believed to be accurate, but not warranted. Please go to web to make sure you have the latest Rev.

DATE	REVISION	CHANGE
September 2, 2016	FN6660.8	Removed Note 8 "Electromigration specification defined as lifetime average junction temperature of +110° C where max rated DC current = lifetime average current" from Recommended Operating Conditions.
April 8, 2016	FN6660.7	Updated Ordering Information table (on page 3), Note 1 to include quantities for tape and reel options. Changed VOUT range upper limit from "5V to 5.5V" on page 1, in the "Recommended Operating Conditions (Note 7)" on page 4 and in the "Output Voltage Selection" on page 12 Electrical Spec table test conditions changed from: $V_{IN} = V_{OUT} + 0.4V$ , $V_{OUT} = 1.8V$ , $C_{IN} = C_{OUT} = 10\mu F$ , $T_J = +25^\circ C$ , $I_{LOAD} = 0A$ , to: $2.2V < V_{IN} < 6V$ , $V_{OUT} = 0.5V$ , $T_J = +25^\circ C$ , $I_{LOAD} = 0A$ Changed Test conditions in "Output Noise Voltage" on page 5 from: $I_{LOAD} = 10mA$ , $BW = 300Hz < f < 300kHz$ ; to: $V_{IN} = 2.2V$ , $V_{OUT} = 1.8V$ , $I_{LOAD} = 3A$ , $BW = 100Hz < f < 100kHz$ and changed TYP from: 100; to: 49 Added two rows to "Dropout Voltage (Note 9)" on page 5 to show parameters for 5.5V $V_{OUT}$ conditions. Updated verbiage for "About Intersil" on page 16. Updated POD L10.3x3 to most updated revision with changes as follows: Added missing dimension 0.415 in Typical Recommended land pattern. Shortened the e-pad rectangle on both the recommended land pattern and the package bottom view to line up with the centers of the corner pins. Changed Tiebar note 4, from: Tiebar shown (if present) is a non-functional feature. to: Tiebar shown (if present) is a non-functional feature and may be located on any of the 4 sides (or ends).
May 23, 2013	FN6660.6	Pin Descriptions on page page 2, updated EPAD section From: EPAD at ground potential. Soldering it directly to GND plane is optional. To: EPAD must be connected to copper plane with as many vias as possible for proper electrical and optimal thermal performance. Removed obsolete part numbers: ISL80102IR33Z, ISL80102IR50Z, ISL80103IR33Z, ISL80103IR50Z from ordering information table on page 3. Added evaluation boards to ordering information table on page 3: ISL80103IR50Z and ISL80103EVAL2Z. Features on page 1: Removed 5 Ld TO220 and 5 Ld TO263. Input Voltage Requirements on page 12: Removed the sentence "those applications that cannot accommodate the profile of the TO220/TO263".
June 14, 2012	FN6660.5	In "Thermal Information" on page 4, corrected $\theta_{JA}$ from 48 to 45.
February 14, 2012	FN6660.4	Increased "VEN(HIGH)" minimum limit from 0.4V to 0.616 and added the "VEN(LOW)" spec for clarity on page 5.
December 14, 2011	FN6660.3	Increased "Turn-on Threshold" minimum limit on page 5 from 0.3V to 0.4V. Updated "Package Outline Drawing" on page 16 as follows: Removed package outline and included center to center distance between lands on recommended land pattern. Removed Note 4 "Dimension b applies to the metallized terminal and is measured between 0.18mm and 0.30mm from the terminal tip." since it is not applicable to this package. Renumbered notes accordingly.
March 4, 2011	FN6660.2	Converted to new template On page 1 - first paragraph, changed "Fixed output voltage options are available in 1.5V, 1.8V, 2.5V, 3.3V and 5V" to "Fixed output voltage options are available in 1.8V, 2.5V, 3.3V and 5V" In "Ordering Information" table on page 2, removed ISL80102IR15Z and ISL80103IR15Z. In Note 3 on page 2, below the "Ordering Information" table, removed '1.5V', so it reads "The 3.3V and 5V fixed output voltages will be released in the future. Please contact Intersil Marketing for more details."



# ISL80102, ISL80103

**Revision History** The revision history provided is for informational purposes only and is believed to be accurate, but not warranted. Please go to web to make sure you have the latest Rev. (Continued)

DATE	REVISION	CHANGE
March 4, 2010	FN6660.1	<p>Corrected Features on page 1 as follows:</p> <ul style="list-style-type: none"> <li>-Changed bullet " • 185mV Dropout @ 3A, 125mV Dropout @ 2A" to " • Very Low 120mV Dropout at 3A"</li> <li>-Changed bullet " • 65dB Typical PSRR" to " • 62dB Typical PSRR"</li> <li>-Deleted 0.5% Initial VOUT Accuracy</li> </ul> <p>Modified Figure 1 and placed as "TYPICAL APPLICATION" on page 1.            Moved Pinout to page 3            In "Block Diagram" on page 2, corrected resistor associated with M5 from R4 to R5            Updated "Block Diagram" on page 2 as follows</p> <ul style="list-style-type: none"> <li>- Added M8 from SS to ground.</li> </ul> <p>Updated Figure 1 on page 1 as follows:</p> <ul style="list-style-type: none"> <li>-Corrected Pin 6 from SS to IRSET</li> <li>-Removed Note 11 callout "Minimum cap on VIN and VOUT required for stability." Added Note "*CSS is optional. See Note 12 on Page 5." and "*** CPB is optional. See "Functional Description" on page 12 for more information."</li> </ul> <p>Added "The 1.5V, 3.3V and 5V fixed output voltages will be released in the future." to Note 3 on page 2.            In "Thermal Information" on page 4, updated Theta JA from 45 to 48.            In "Soft-Start Operation (Optional)" on page 12:</p> <ul style="list-style-type: none"> <li>-Changed "The external capacitor always gets discharged to 0V at start-up of after coming out of a chip disable. "The external capacitor always gets discharged to ground pin potential at start-up or enabling."</li> <li>-Changed "The soft-start function effectively limits the amount of inrush current below the programmed current limit during start-up or an enable sequence to avoid an overcurrent fault condition." to "The soft-start feature effectively reduces the inrush current at power-up or LDO enable until VOUT reaches regulation."</li> <li>-Added "See Figures 25 through 27 in the "Typical Operating Performance Curves" beginning on page 6."</li> <li>-Added "RPD is the on resistance of the pull-down MOSFET, M8. RPD is 300Ω typically."</li> </ul>
March 4, 2010		<p>Added "Phase Boost Capacitor (Optional)" on page 13.            In "Typical Operating Performance" on page 11, revised figure "PSRR vs VIN" which had 3 curves with "SPECTRAL NOISE DENSITY vs FREQUENCY" which has one curve.            Added "Figure 33. "LOAD TRANSIENT 0A TO 3A, C<sub>OUT</sub> = 10μF CERAMIC, NO CPB (ADJ VERSION)" and "Figure 34. "LOAD TRANSIENT 0A TO 3A, C<sub>OUT</sub> = 10μF CERAMIC, CPB = 1500pF (ADJ VERSION)"</p>
September 30, 2009	FN6660.0	Initial Release.

## About Intersil

Intersil Corporation is a leading provider of innovative power management and precision analog solutions. The company's products address some of the largest markets within the industrial and infrastructure, mobile computing and high-end consumer markets.

For the most updated datasheet, application notes, related documentation and related parts, please see the respective product information page found at [www.intersil.com](http://www.intersil.com).

You may report errors or suggestions for improving this datasheet by visiting [www.intersil.com/ask](http://www.intersil.com/ask).

Reliability reports are also available from our website at [www.intersil.com/support](http://www.intersil.com/support).

For additional products, see [www.intersil.com/en/products.html](http://www.intersil.com/en/products.html)

Intersil products are manufactured, assembled and tested utilizing ISO9001 quality systems as noted in the quality certifications found at [www.intersil.com/en/support/qualandreliability.html](http://www.intersil.com/en/support/qualandreliability.html)

*Intersil products are sold by description only. Intersil Corporation reserves the right to make changes in circuit design, software and/or specifications at any time without notice. Accordingly, the reader is cautioned to verify that data sheets are current before placing orders. Information furnished by Intersil is believed to be accurate and reliable. However, no responsibility is assumed by Intersil or its subsidiaries for its use; nor for any infringements of patents or other rights of third parties which may result from its use. No license is granted by implication or otherwise under any patent or patent rights of Intersil or its subsidiaries.*

For information regarding Intersil Corporation and its products, see [www.intersil.com](http://www.intersil.com)

# ISL80102, ISL80103

## Package Outline Drawing

L10.3x3

10 LEAD DUAL FLAT PACKAGE (DFN)

Rev 11, 3/15

For the most recent package outline drawing, see [L10.3x3](#).

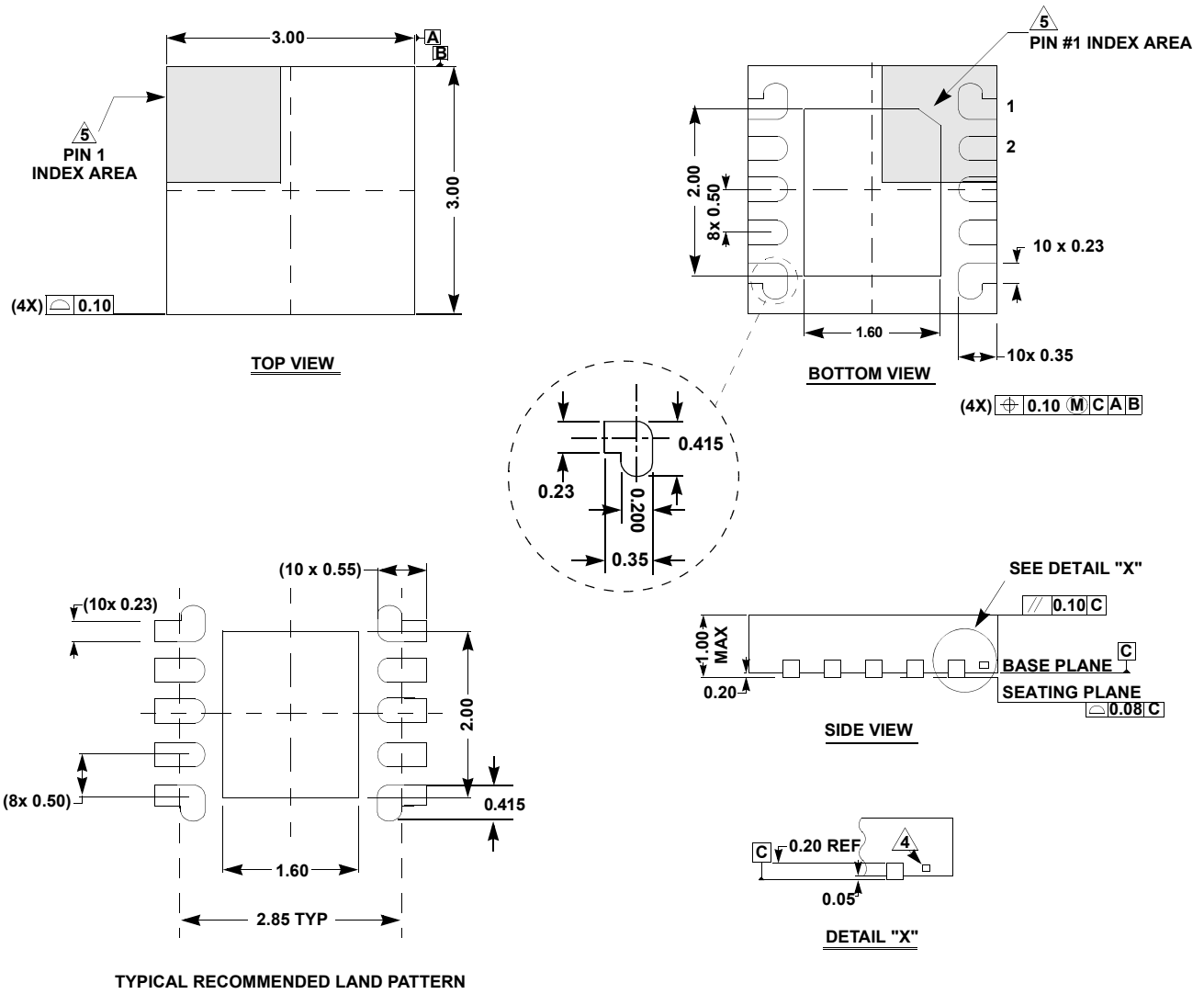

### NOTES:

- Dimensions are in millimeters.  
Dimensions in ( ) for Reference Only.
- Dimensioning and tolerancing conform to ASME Y14.5m-1994.
- Unless otherwise specified, tolerance : Decimal  $\pm 0.05$
- Tiebar shown (if present) is a non-functional feature and may be located on any of the 4 sides (or ends).
- The configuration of the pin #1 identifier is optional, but must be located within the zone indicated. The pin #1 identifier may be either a mold or mark feature.



## X-ON Electronics

Largest Supplier of Electrical and Electronic Components

*Click to view similar products for [LDO Voltage Regulators](#) category:*

*Click to view products by [Renesas](#) manufacturer:*

Other Similar products are found below :

[M38D29FFHP#U1](#) [702103A](#) [717726C](#) [742457H](#) [MP20051DN-LF-Z](#) [R5F111PGGFB#30](#) [AP7363-SP-13](#) [NCP103AMX285TCG](#)  
[NCV8664CST33T3G](#) [NCV8752AMX28TCG](#) [L9454](#) [AP7362-HA-7](#) [LX13043CLD](#) [TCR3DF185,LM\(CT](#) [TCR3DF24,LM\(CT](#)  
[TCR3DF285,LM\(CT](#) [TCR3DF31,LM\(CT](#) [TCR3DF45,LM\(CT](#) [TLF4949EJ](#) [MP2013GQ-33-Z](#) [L9708](#) [L970813TR](#) [030014BB](#) [059985X](#)  
[NCP121AMX173TCG](#) [NCP4687DH15T1G](#) [NCV8703MX30TCG](#) [701326R](#) [702087BB](#) [755078E](#) [TCR2EN28,LF\(S](#) [LM1117DT-1.8/NO](#)  
[LT1086CM#TRPBF](#) [AZ1085S2-1.5TRE1](#) [MAX15101EWL+T](#) [NCV8170AXV250T2G](#) [SCD337BTG](#) [TCR3DF27,LM\(CT](#)  
[TCR3DF19,LM\(CT](#) [TCR3DF125,LM\(CT](#) [TCR2EN18,LF\(S](#) [MAX15103EWL+T](#) [TS2937CZ-5.0 C0](#) [MAX8878EUK30-T](#) [MAX663CPA](#)  
[NCV4269CPD50R2G](#) [NCV8716MT30TBG](#) [AZ1117IH-1.2TRG1](#) [MP2013GQ-P](#) [AP2112R5A-3.3TRG1](#)