

■Features

- Single chip
- Super high brightness of surface mount LED
- Compact package outline
(L x W x T) of 3.2mm x 1.6mm x 0.8mm
- Compatible to IR reflow soldering.

■Applications

- Backlighting (switches, keys, etc.)
- Marker lights (e.g. steps, exit ways, etc.)

■Outline Dimension

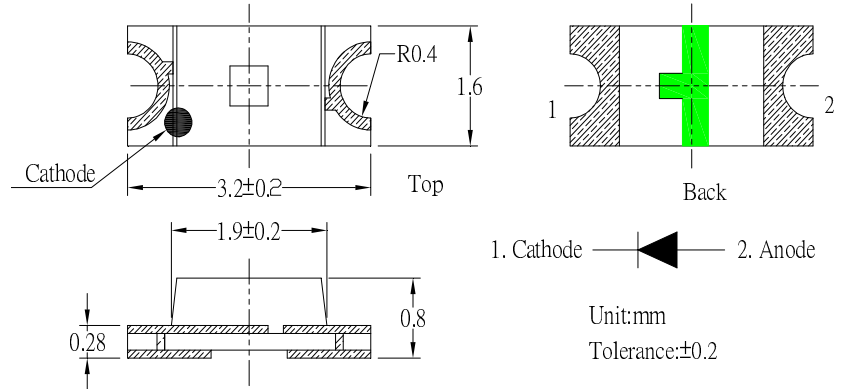

■Absolute Maximum Rating

(Ta=25°C)

Item	Symbol	Value		Unit
		WT/MT/BL/TG	YG/YL//OR/HR	
DC Forward Current	I _F	30	30	mA
Pulse Forward Current*	I _{FP}	100	100	mA
Reverse Voltage	V _R	5	5	V
Power Dissipation	P _D	108	78	mW
Operating Temperature	T _{opr}	-40 ~ +85		°C
Storage Temperature	T _{stg}	-40~ +85		°C
Lead Soldering Temperature	T _{sol}	260°C/5sec		-

*Pulse width Max 0.1ms, Duty ratio max 1/10

■Directivity

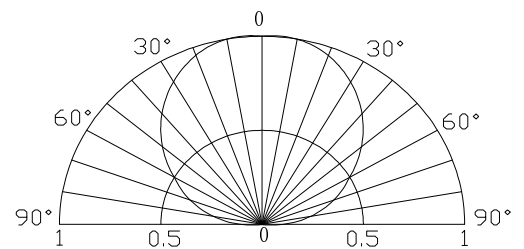

■Electrical -Optical Characteristics

(Ta=25°C)

Part Number	Color		V _F (V)			I _R (μA)	I _v (mcd)			λD (nm)			2θ1/2 (deg)
			Min.	Typ.	Max.	Max.	Min.	Typ.	Max.	Min.	Typ.	Max.	Typ.
			I _F =20mA			V _R =5V		I _F =20mA					
OSW51206C1E	White	W5	3.0	-	3.6	100	400	450	-	X=0.29 Y=0.29			120
OSM51206C1E	Warm White	M5	3.0	-	3.6	100	400	450	-	X:0.44, Y:0.41			120
OSB51206C1E	Blue	B5	3.0	-	3.6	100	80	100	-	460	465	475	120
OSG51206C1E	True Green	G5	2.9	-	3.6	100	300	350	-	520	525	530	120
OSG81206C1E	Yellow green	G8	1.8	-	2.6	100	20	45	-	565	570	575	120
OSY51206C1E	Yellow	Y5	1.8	-	2.6	100	60	90	-	585	590	595	120
OSR51206C1E	Red	R5	1.8	-	2.6	100	100	120	-	620	625	630	120

Note: * V_f tolerance: ±0.05V

* Dominant wavelength tolerance: ±1nm

* Luminous intensity is NIST reading. Luminous intensity tolerance: ±10%

■ **Optical and electrical characteristics**

TYPICAL ELECTRICAL/OPTICAL CHARACTERISTIC CURVES

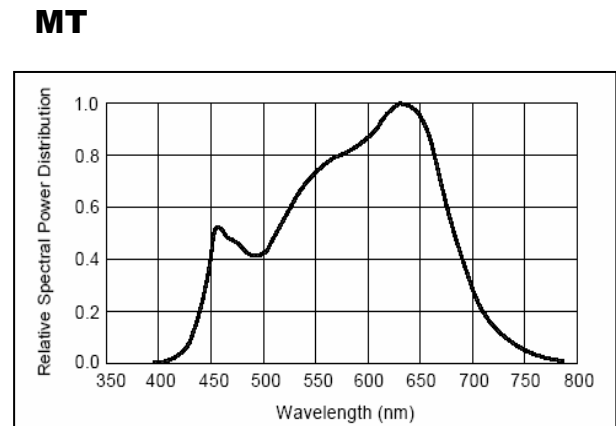
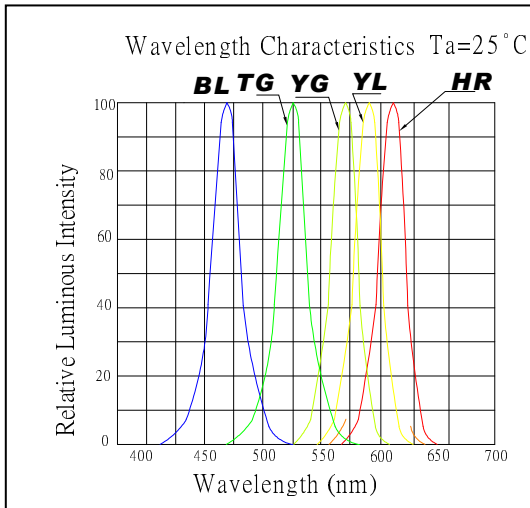
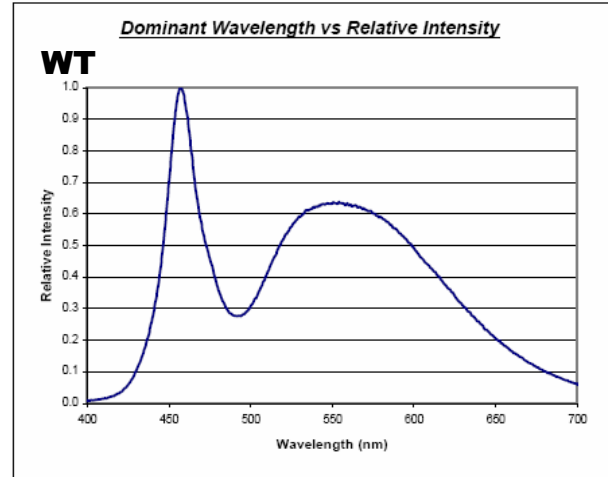
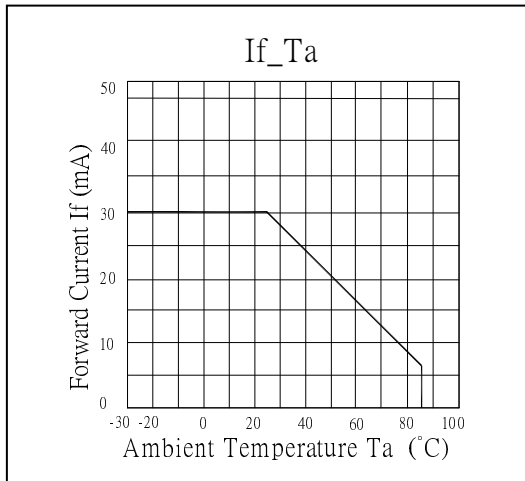
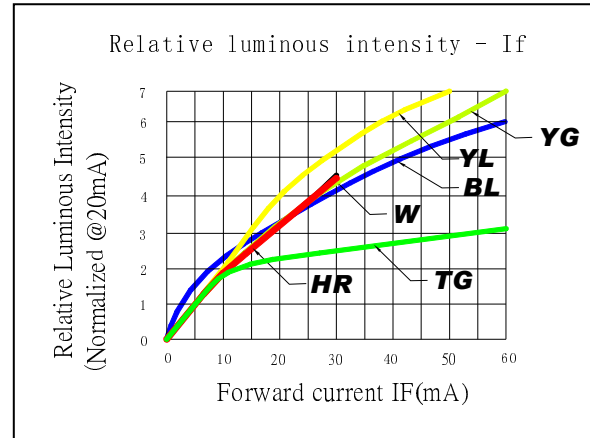
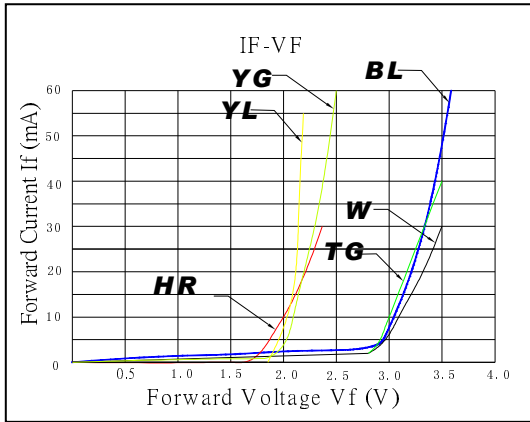

X-ON Electronics

Largest Supplier of Electrical and Electronic Components

Click to view similar products for [Standard LEDs - SMD category](#):

Click to view products by [Optosupply manufacturer](#):

Other Similar products are found below :

[LTST-C19GD2WT](#) [LTST-N683GBEW](#) [597-3006-607F](#) [597-3403-607F](#) [LTW-K140SZR40](#) [LTW-M140ZVS](#) [598-8110-100F](#) [598-8170-100F](#)
[598-8610-202F](#) [7012X7](#) [AAAF5060QBFSEEZGS](#) [12-22SURSYGC/S530-A3/E2/TR8](#) [1383SURT/S530-A3/TR1\(R\)](#) [APT1608QGW](#)
[EASV1803BA0](#) [HT-F104TW-5860](#) [SML310BATT86](#) [SML-512VWT86A](#) [SML-LX0606SISUGC/A](#) [SML-LXL1307SRC-TR](#) [SML-](#)
[LXR851SIUPGUBC](#) [LT1ED53A](#) [17-21/G6C-FM1N2B/3T](#) [FAT801-S](#) [SSL-LXA227IC-TR31A](#) [AM27ZGC03](#) [APB3025SGNC](#)
[APHK1608VGCA](#) [APT2012QGW](#) [CLMVC-FKA-CA1E1L81BB7C3C3](#) [CLYBA-FKA-CFHHL9BBB7A363](#) [CMD11504UR](#) [LTW-](#)
[020ZDCG](#) [LTW-21TS5](#) [LTW-K140SZR30](#) [HSMY-C177](#) [HT-121UYG-4739](#) [UYGT801-S](#) [KVH1C100MF6R](#) [42-21SYGC/S530-E1/TR8](#)
[YGFR411-H](#) [597-2311-402F](#) [5973212407NF](#) [597-3302-607F](#) [597-5202-407F](#) [598-8330-117F](#) [SAW8WA2A-L35M40-CA](#) [SML013WBDW1](#)
[SML522BUWT86](#) [SML-LX0402IC-TR](#)