

# PME271Y Series Metallized Impregnated Paper, Class Y2, 250 VAC

## Overview

The PME271Y Series is constructed of multilayer metallized paper encapsulated and impregnated in self-extinguishing material meeting the requirements of UL 94 V-0.

## Applications

Typical applications include worldwide use as electromagnetic interference suppressor in all Y2 applications, line-to-earth.

## Benefits

- Approvals: ENEC, UL, cUL, CQC
- Rated voltage: 250 VAC 50/60 Hz
- Capacitance range: 0.001 – 0.1  $\mu$ F
- Lead spacing: 10.2 – 25.4 mm
- Capacitance tolerance:  $\pm$ 20%
- Climatic category: 40/100/56/B, IEC 60068-1
- Tape and reel packaging in accordance with IEC 60286-2
- RoHS Compliant and lead-free terminations
- Operating temperature range of  $-40^{\circ}\text{C}$  to  $+100^{\circ}\text{C}$
- 100% screening factory test at 3,000 VDC
- Highest possible safety regarding active and passive flammability



## Legacy Part Number System

PME271	Y	410	M	R30
Series	Rated Voltage (VAC)	Capacitance Code (pF)	Capacitance Tolerance	Packaging
Y2, Metallized Paper	Y = 250	The last two digits represent significant figures. The first digit specifies the total number of digits.	M = $\pm$ 20%	See Ordering Options Table

## New KEMET Part Number System

P	271	H	E	102	M	250	A
Capacitor Class	Series	Lead Spacing (mm)	Size Code	Capacitance Code (pF)	Capacitance Tolerance	Rated Voltage (VAC)	Lead and Packaging Code
P = Paper	Y2, Metallized Paper	H = 10.2 Q = 15.2 C = 20.3 E = 25.4	See Dimension Table	First two digits represent significant figures. Third digit specifies number of zeros.	M = $\pm$ 20%	250 = 250	See Ordering Options Table

## Benefits cont'd

- Excellent self-healing properties ensure long life even when subjected to frequent over-voltages
- Good resistance to ionization due to impregnated dielectric
- High dV/dt capability
- Impregnated paper ensures excellent stability and reliability properties, particularly in applications with continuous operation

## Ordering Options Table

Lead Spacing Nominal (mm)	Type of Leads and Packaging	Lead Length (mm)	KEMET Lead and Packaging Code	Legacy Lead and Packaging Code
10.2	<b>Standard Lead and Packaging Options</b>			
	Bulk (Bag) – Short Leads	6 +0/-1	C	R06
	Bulk (Bag) – Max Length Leads	30 +5/-0	A	R30
	Tape & Reel (Standard Reel)	$H_0 = 18.5 \pm 0.5$	L	R19T0
	<b>Other Lead and Packaging Options</b>			
	Tape & Reel (Large Reel)	$H_0 = 18.5 \pm 0.5$	P	R19T1
<b>Native 10.2 formed to 7.5</b>	Ammo Pack	$H_0 = 16.5 \pm 0.5$	LAF3	R30XA
15.2	<b>Standard Lead and Packaging Options</b>			
	Bulk (Bag) – Short Leads	6 +0/-1	C	R06
	Bulk (Bag) – Max Length Leads	30 +5/-0	A	R30
	Tape & Reel (Standard Reel)	$H_0 = 18.5 \pm 0.5$	L	R19T0
	<b>Other Lead and Packaging Options</b>			
	Tape & Reel (Large Reel)	$H_0 = 18.5 \pm 0.5$	P	R19T1
20.3	<b>Standard Lead and Packaging Options</b>			
	Bulk (Tray) – Short Leads	6 +0/-1	C	R06
	Bulk (Bag) – Max Length Leads	30 +5/-0	A	R30
	Tape & Reel (Standard Reel)	$H_0 = 18.5 \pm 0.5$	L	R19T0
	<b>Other Lead and Packaging Options</b>			
	Tape & Reel (Large Reel)	$H_0 = 18.5 \pm 0.5$	P	R19T1
25.4	<b>Standard Lead and Packaging Options</b>			
	Bulk (Tray) – Short Leads	6 +0/-1	C	R06
	Bulk (Bag) – Max Length Leads	30 +5/-0	A	R30

## Dimensions – Millimeters

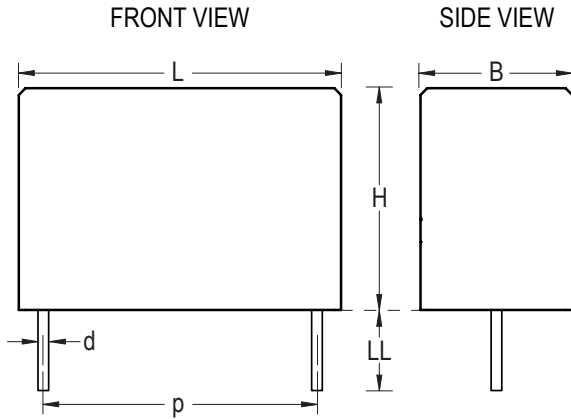

p		B		H		L		d	
Nominal	Tolerance	Nominal	Tolerance	Nominal	Tolerance	Nominal	Tolerance	Nominal	Tolerance
10.2	+/-0.4	3.9	Maximum	7.5	Maximum	13.5	Maximum	0.6	+/-0.05
10.2	+/-0.4	4.1	Maximum	8.2	Maximum	13.5	Maximum	0.6	+/-0.05
10.2	+/-0.4	5.1	Maximum	10.5	Maximum	13.5	Maximum	0.6	+/-0.05
15.2	+/-0.4	5.2	Maximum	10.5	Maximum	18.5	Maximum	0.8	+/-0.05
15.2	+/-0.4	5.5	Maximum	11	Maximum	18.5	Maximum	0.8	+/-0.05
15.2	+/-0.4	7.3	Maximum	13	Maximum	18.5	Maximum	0.8	+/-0.05
20.3	+/-0.4	7.6	Maximum	14	Maximum	24	Maximum	0.8	+/-0.05
20.3	+/-0.4	9	Maximum	15	Maximum	24	Maximum	0.8	+/-0.05
20.3	+/-0.4	11.3	Maximum	16.5	Maximum	24	Maximum	0.8	+/-0.05
25.4	+/-0.4	12.1	Maximum	19	Maximum	30.5	Maximum	1	+/-0.05

Note: See Ordering Options Table for lead length (LL) options.



## Performance Characteristics

Rated Voltage	250 VAC 50/60 Hz	
Capacitance Range	0.001 – 0.1 $\mu$ F	
Capacitance Tolerance	$\pm$ 20%	
Temperature Range	–40°C to +100°C	
Climatic Category	40/100/56/B	
Approvals	ENEC, UL, CSA, CQC	
Dissipation Factor	Maximum Values at +23°C	
	1 kHz	1.3%
Test Voltage Between Terminals	The 100% screening factory test is carried out at 3,000 VDC. The voltage level is selected to meet the requirements in applicable equipment standards. All electrical characteristics are checked after the test. It is not permitted to repeat this test as there is a risk to damage the capacitor. KEMET is not liable in such case for any failures.	
Insulation Resistance	Minimum Value Between Terminals	
	$\geq$ 12,000 M $\Omega$	
In DC Applications	Recommended voltage $\leq$ 1,000 VDC	

## Environmental Test Data

Test	IEC Publication	Procedure
Vibration	IEC 60068–2–6 Test Fc	3 directions at 2 hours each 10 – 500 Hz at 0.75 mm or 98 m/s <sup>2</sup>
Bump	IEC 60068–2–29 Test Eb	4,000 bumps at 390 m/s <sup>2</sup>
Solderability	IEC 60068–2–20 Test Ta	Solder globule method
Active Flammability	IEC 60384–14	
Passive Flammability	IEC 60384–14	Needle-flame test
Humidity	IEC 60068–2–3 Test Ca	+40°C and 90 – 95% RH

## Approvals

Mark	Specification	File Number
	EN/IEC 60384-14	SE/0140-27D
	UL 60384-14 CAN/CSA-E60384-14-09	E73869
	CQC	10001043355

## Environmental Compliance

All KEMET EMI capacitors are RoHS Compliant.

### Table 1 – Ratings & Part Number Reference

Capacitance Value (μF)	Maximum Dimensions in mm			Lead Spacing (p)	f <sub>o</sub> (MHz)	dV/dt (V/μs)	New KEMET Part Number	Legacy Part Number
	B	H	L					
0.0010	3.9	7.5	13.5	10.2	53	2000	P271HE102M250(1)	PME271Y410M(1)
0.0015	3.9	7.5	13.5	10.2	44	2000	P271HE152M250(1)	PME271Y415M(1)
0.0022	3.9	7.5	13.5	10.2	37	2000	P271HE222M250(1)	PME271Y422M(1)
0.0033	4.1	8.2	13.5	10.2	30	2000	P271HH332M250(1)	PME271Y433M(1)
0.0047	5.1	10.5	13.5	10.2	24	2000	P271HL472M250(1)	PME271Y447M(1)
0.0068	5.2	10.5	18.5	15.2	19	1400	P271QE682M250(1)	PME271Y468M(1)
0.0100	5.2	10.5	18.5	15.2	16	1400	P271QE103M250(1)	PME271Y510M(1)
0.0150	5.5	11.0	18.5	15.2	13	1400	P271QH153M250(1)	PME271Y515M(1)
0.0220	7.3	13.0	18.5	15.2	9.8	1400	P271QM223M250(1)	PME271Y522M(1)
0.0330	7.6	14.0	24.0	20.3	7.0	1000	P271CE333M250(1)	PME271Y533M(1)
0.0470	9.0	15.0	24.0	20.3	6.0	1000	P271CJ473M250(1)	PME271Y547M(1)
0.0680	11.3	16.5	24.0	20.3	4.6	600	P271CP683M250(1)	PME271Y568M(1)
0.1000	12.1	19.0	30.5	25.4	3.9	400	P271EJ104M250(1)	PME271Y610M(1)
Capacitance Value (μF)	B (mm)	H (mm)	L (mm)	Lead Spacing (p)	f <sub>o</sub> (MHz)	dV/dt (V/μs)	New KEMET Part Number	Legacy Part Number

(1) Insert ordering code for lead type and packaging. See Ordering Options Table for available options.

## Soldering Process

The implementation of the RoHS directive has resulted in the selection of SnAgCu (SAC) alloys or SnCu alloys as primary solder. This has increased the liquidus temperature from that of 183°C for SnPb eutectic alloy to 217 – 221°C for the new alloys. As a result, the heat stress to the components, even in wave soldering, has increased considerably due to higher pre-heat and wave temperatures. Polypropylene capacitors are especially sensitive to heat (the melting point of polypropylene is 160 – 170°C). Wave soldering can be destructive, especially for mechanically small polypropylene capacitors (with lead spacing of 5 mm to 15 mm), and great care has to be taken during soldering. The recommended solder profiles from KEMET should be used. Please consult KEMET with any questions. In general, the wave soldering curve from IEC Publication 61760-1 Edition 2 serves as a solid guideline for successful soldering. Please see Figure 1.

Reflow soldering is not recommended for through-hole film capacitors. Exposing capacitors to a soldering profile in excess of the above the recommended limits may result to degradation or permanent damage to the capacitors.

Do not place the polypropylene capacitor through an adhesive curing oven to cure resin for surface mount components. Insert through-hole parts after the curing of surface mount parts. Consult KEMET to discuss the actual temperature profile in the oven, if through-hole components must pass through the adhesive curing process. A maximum two soldering cycles is recommended. Please allow time for the capacitor surface temperature to return to a normal temperature before the second soldering cycle.

### Manual Soldering Recommendations

Following is the recommendation for manual soldering with a soldering iron.

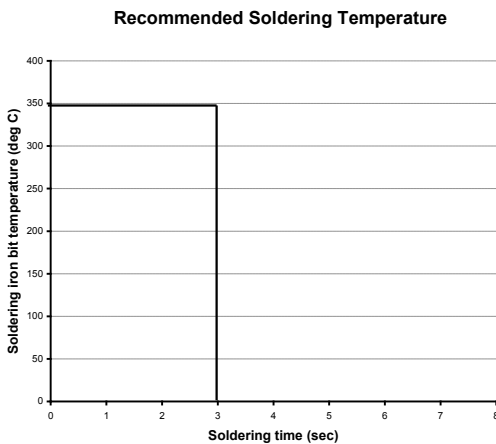

The soldering iron tip temperature should be set at 350°C (+10°C maximum) with the soldering duration not to exceed more than 3 seconds.

### Wave Soldering Recommendations

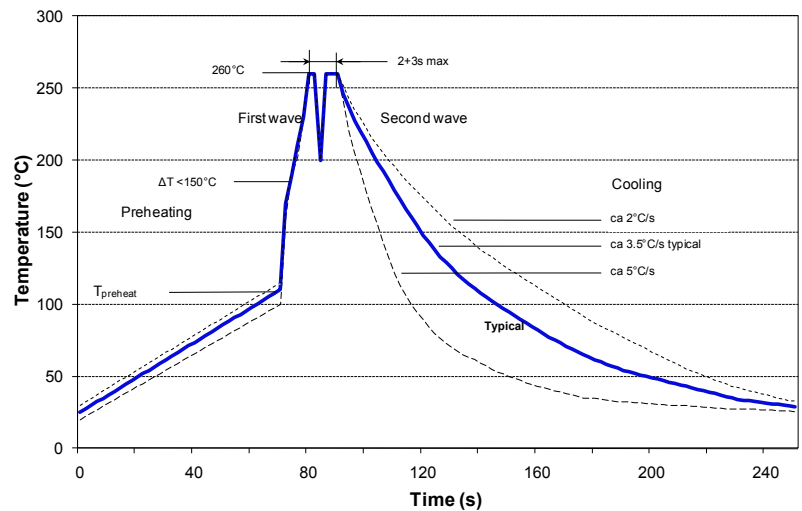

## Soldering Process cont'd

### Wave Soldering Recommendations cont'd

1. The table indicates the maximum set-up temperature of the soldering process

Figure 1

Dielectric Film Material	Maximum Preheat Temperature			Maximum Peak Soldering Temperature	
	Capacitor Pitch ≤ 10 mm	Capacitor Pitch = 15 mm	Capacitor Pitch > 15 mm	Capacitor Pitch ≤ 15 mm	Capacitor Pitch > 15 mm
Polyester	130°C	130°C	130°C	270°C	270°C
Polypropylene	100°C	110°C	130°C	260°C	270°C
Paper	130°C	130°C	140°C	270°C	270°C
Polyphenylene Sulphide	150°C	150°C	160°C	270°C	270°C

2. The maximum temperature measured inside the capacitor:

Set the temperature so that inside the element the maximum temperature is below the limit:

Dielectric Film Material	Maximum temperature measured inside the element
Polyester	160°C
Polypropylene	110°C
Paper	160°C
Polyphenylene sulphide	160°C

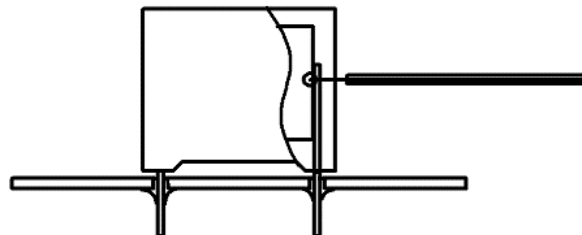

*Temperature monitored inside the capacitor.*

### Selective Soldering Recommendations

Selective dip soldering is a variation of reflow soldering. In this method, the printed circuit board with through-hole components to be soldered is preheated and transported over the solder bath as in normal flow soldering without touching the solder. When the board is over the bath, it is stopped and pre-designed solder pots are lifted from the bath with molten solder only at the places of the selected components, and pressed against the lower surface of the board to solder the components.

The temperature profile for selective soldering is similar to the double wave flow soldering outlined in this document, **however, instead of two baths, there is only one bath with a time from 3 to 10 seconds.** In selective soldering, the risk of overheating is greater than in double wave flow soldering, and great care must be taken so that the parts are not overheated.

## Construction

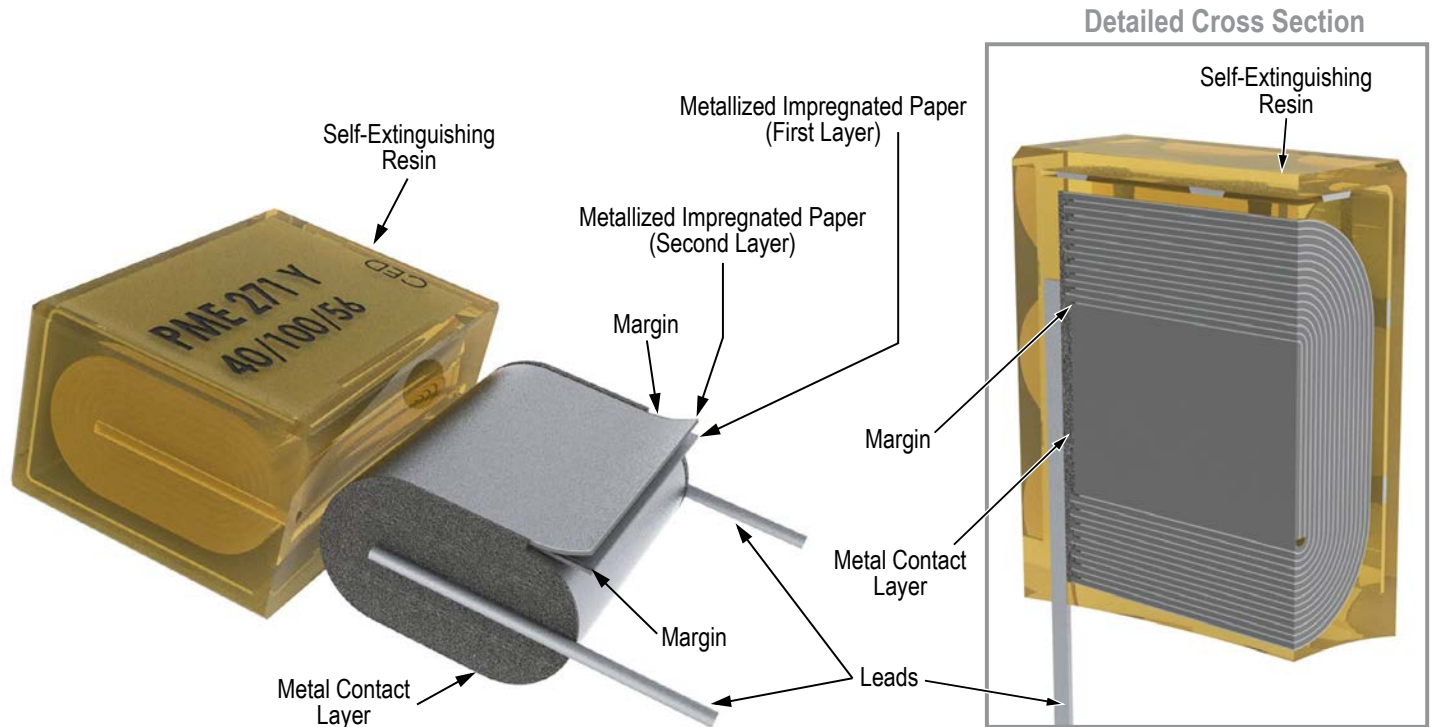

## Winding Scheme

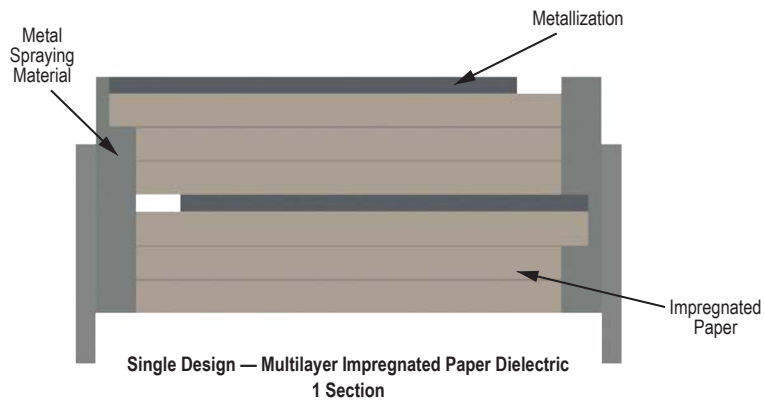



## Marking

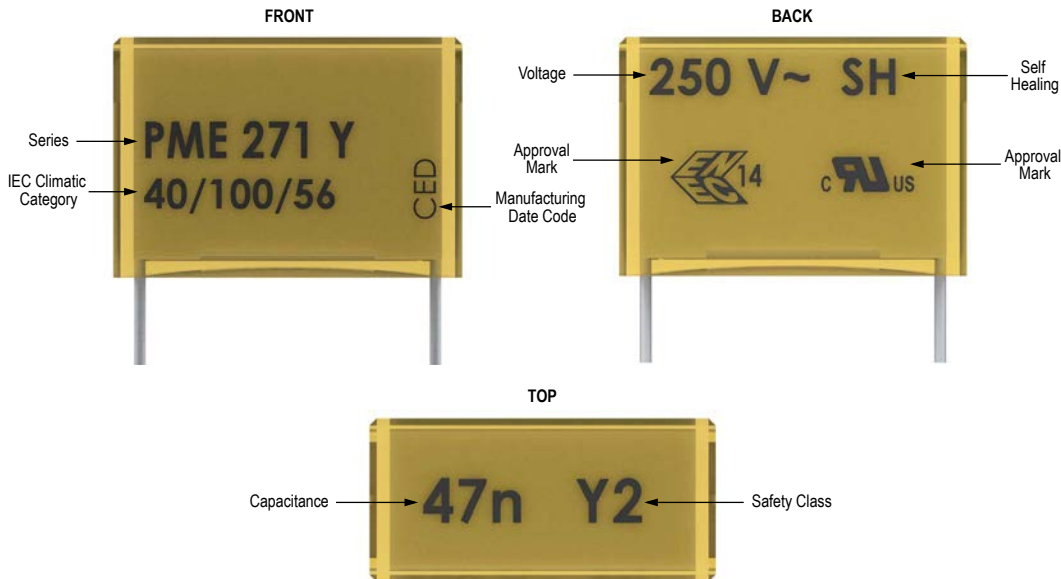

## Packaging Quantities

Lead Spacing (mm)	Thickness (mm)	Height (mm)	Length (mm)	Bulk Short Leads	Bulk Long Leads	Standard Reel ø 360 mm	Large Reel ø 500 mm	Ammo Formed
10.2	3.9	7.5	13.5	2000	1000	700	1400	800
	4.1	8.2	13.5	2000	1000	600		780
	5.1	10.5	13.5	1600	800	600	1200	630
15.2	5.5	12.5	18	1000	500	600		
	6.5	12.5	18	600	400	400		
	7.5	14.5	18	600	400	400		
	8.5	16	18	400	250	400		
	5.2	10.5	18.5	1000	500	600		
	5.5	11	18.5	1000	500	500		
	6	12.5	18.5	600	400	400		800
	7.3	13	18.5	600	400	400		
	7.8	13.5	18.5	600	400	400		
8.5	14.3	18.5	500	300	350			
20.3	7.6	14	24	1500	250	250	500	
	8.4	14	24	1200	200	250	500	
	9	15	24	1500	200	250		
	11.3	16.5	24	1000	150	180	400	
25.4	10.6	16.1	30.5	1000	150			
	10.5	17.3	30.5	1000	100			
	12.1	19	30.5	800	100			
	15.3	22	30.5	600	75			

## Lead Taping & Packaging (IEC 60286–2)

### Lead Spacing 10.2 – 15.2 mm

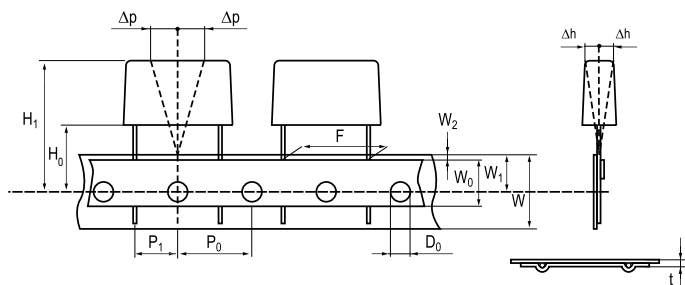

### Lead Spacing 20.3 – 22.5 mm

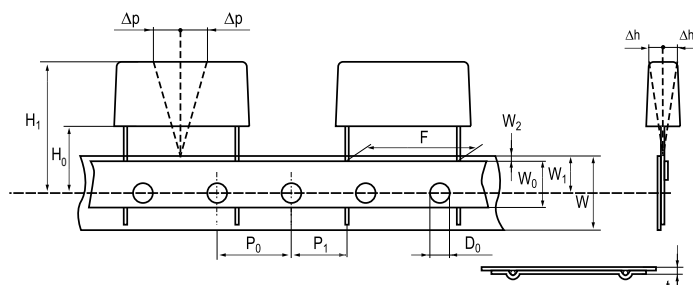

### Formed Leads from 10.2 to 7.5 mm

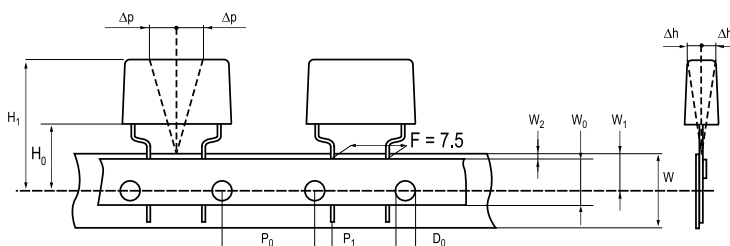

## Taping Specification

Dimensions in mm								Standard IEC 60286–2
Lead spacing	+6/-0.1	F	Formed 7.5	10.2	15.2	20.3	22.5	F
Carrier tape width	+/-0.5	W	18	18	18	18	18	18 <sup>+1/-0.5</sup>
Hold-down tape width	+/-0.3	W <sub>0</sub>	9	12	12	12	12	
Position of sprocket hole	+/-0.5	W <sub>1</sub>	9	9	9	9	9	9 <sup>+0.75/-0.5</sup>
Distance between tapes	Maximum	W <sub>2</sub>	3	3	3	3	3	3
Sprocket hole diameter	+/-0.2	D <sub>0</sub>	4	4	4	4	4	4
Feed hole lead spacing	+/-0.3	P <sub>0</sub> <sup>(1)</sup>	12.7 <sup>(4)</sup>	12.7	12.7	12.7	12.7	12.7
Distance lead – feed hole	+/-0.7	P <sub>1</sub>	3.75	7.6	5.1	8.9	5.3	P <sup>1</sup>
Deviation tape – plane	Maximum	Δp	1.3	1.3	1.3	1.3	1.3	1.3
Lateral deviation	Maximum	Δh	2	2	2	2	2	2
Total thickness	+/-0.2	t	0.7	0.7	0.7	0.7	0.9 <sup>MAX</sup>	0.9 <sup>MAX</sup>
Sprocket hole/cap body	Nominal	H <sub>0</sub> <sup>(2)</sup>	18 <sup>+2/-0</sup>	18 <sup>+2/-0</sup>	18 <sup>+2/-0</sup>	18 <sup>+2/-0</sup>	18.5 <sup>+/-0.5</sup>	18 <sup>+2/-0</sup>
Sprocket hole/top of cap body	Maximum	H <sub>1</sub> <sup>(3)</sup>	35	35	35	35	58	58 <sup>MAX</sup>

(1) Maximum cumulative feed hole error, 1 mm per 20 parts.

(2) 16.5 mm available on request.

(3) Depending on case size.

(4) 15 mm available on request.

## Lead Taping & Packaging (IEC 60286–2) cont'd

### Ammo Specifications

Series	Dimensions (mm)		
	H	W	T
R4x, R4x+R, R7x, RSB	360	340	59
F5A, F5B, F5D			
F6xx, F8xx			
PHExxx, PMExxx, PMRxxx	330	330	50

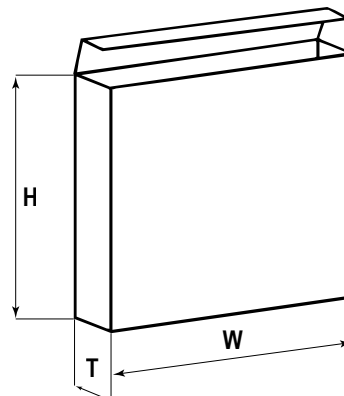

### Reel Specifications

Series	Dimensions (mm)		
	D	H	W
R4x, R4x+R, R7x, RSB	355 500	30	55 (Max)
F5A, F5B, F5D		25	
F6xx, F8xx			
PHExxx, PMExxx, PMRxxx	360 500	30	46 (Max)

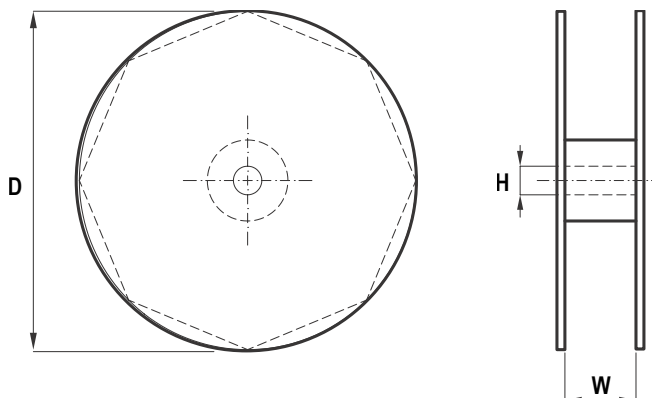

### Manufacturing Date Code (IEC–60062)

Y = Year, Z = Month			
Year	Code	Month	Code
2000	M	January	1
2001	N	February	2
2002	P	March	3
2003	R	April	4
2004	S	May	5
2005	T	June	6
2006	U	July	7
2007	V	August	8
2008	W	September	9
2009	X	October	0
2010	A	November	N
2011	B	December	D
2012	C		
2013	D		
2014	E		
2015	F		
2016	H		
2017	J		
2018	K		
2019	L		
2020	M		

## KEMET Corporation World Headquarters

2835 KEMET Way  
Simpsonville, SC 29681

Mailing Address:  
P.O. Box 5928  
Greenville, SC 29606

www.kemet.com  
Tel: 864-963-6300  
Fax: 864-963-6521

**Corporate Offices**  
Fort Lauderdale, FL  
Tel: 954-766-2800

## North America

**Northeast**  
Wilmington, MA  
Tel: 978-658-1663

**Southeast**  
Lake Mary, FL  
Tel: 407-855-8886

**Central**  
Novi, MI  
Tel: 248-994-1030

Irving, TX  
Tel: 972-915-6041

**West**  
Milpitas, CA  
Tel: 408-433-9950

**Mexico**  
Guadalajara, Jalisco  
Tel: 52-33-3123-2141

## Europe

**Southern Europe**  
Sasso Marconi, Italy  
Tel: 39-051-939111

Skopje, Macedonia  
Tel: 389-2-55-14-623

**Central Europe**  
Landsberg, Germany  
Tel: 49-8191-3350800

Kamen, Germany  
Tel: 49-2307-438110

**Northern Europe**  
Wyboston, United Kingdom  
Tel: 44-1480-273082

Espoo, Finland  
Tel: 358-9-5406-5000

## Asia

**Northeast Asia**  
Hong Kong  
Tel: 852-2305-1168

Shenzhen, China  
Tel: 86-755-2518-1306

Beijing, China  
Tel: 86-10-5877-1075

Shanghai, China  
Tel: 86-21-6447-0707

Seoul, South Korea  
Tel: 82-2-6294-0550

Taipei, Taiwan  
Tel: 886-2-27528585

**Southeast Asia**  
Singapore  
Tel: 65-6701-8033

Penang, Malaysia  
Tel: 60-4-6430200

Bangalore, India  
Tel: 91-806-53-76817

*Note: KEMET reserves the right to modify minor details of internal and external construction at any time in the interest of product improvement. KEMET does not assume any responsibility for infringement that might result from the use of KEMET Capacitors in potential circuit designs. KEMET is a registered trademark of KEMET Electronics Corporation.*

## Disclaimer

All product specifications, statements, information and data (collectively, the "Information") in this datasheet are subject to change. The customer is responsible for checking and verifying the extent to which the Information contained in this publication is applicable to an order at the time the order is placed.

All Information given herein is believed to be accurate and reliable, but it is presented without guarantee, warranty, or responsibility of any kind, expressed or implied.

Statements of suitability for certain applications are based on KEMET Electronics Corporation's ("KEMET") knowledge of typical operating conditions for such applications, but are not intended to constitute – and KEMET specifically disclaims – any warranty concerning suitability for a specific customer application or use. The Information is intended for use only by customers who have the requisite experience and capability to determine the correct products for their application. Any technical advice inferred from this Information or otherwise provided by KEMET with reference to the use of KEMET's products is given gratis, and KEMET assumes no obligation or liability for the advice given or results obtained.

Although KEMET designs and manufactures its products to the most stringent quality and safety standards, given the current state of the art, isolated component failures may still occur. Accordingly, customer applications which require a high degree of reliability or safety should employ suitable designs or other safeguards (such as installation of protective circuitry or redundancies) in order to ensure that the failure of an electrical component does not result in a risk of personal injury or property damage.

Although all product-related warnings, cautions and notes must be observed, the customer should not assume that all safety measures are indicated or that other measures may not be required.

## X-ON Electronics

Largest Supplier of Electrical and Electronic Components

*Click to view similar products for [Film Capacitors](#) category:*

*Click to view products by [Kemet](#) manufacturer:*

Other Similar products are found below :

[F339X134748MIP2T0](#) [F450KG153J250ALH0J](#) [750-1018](#) [FKP1-1500160010P15](#) [FKP1R031007D00JYSD](#) [FKP1R031507E00JYSD](#)  
[FKP1U024707E00KYSD](#) [82DC4100CK60J](#) [82EC1100DQ50K](#) [PFR5101J100J11L16.5TA18](#) [PME261JB5220KR19T0](#) [A451GK223M040A](#)  
[A561ED221M450A](#) [QXJ2E474KTPT](#) [QXL2B333KTPT](#) [R49AN347000A1K](#) [EEC2G505HQA406](#) [B25668A6676A375](#) [B25673A4282E140](#)  
[BFC233868148](#) [BFC2370GC222](#) [C3B2AD44400B20K](#) [C4ASWBU3220A3EK](#) [CB027C0473J--](#) [CB177I0184J--](#) [CB182K0184J--](#) [23PW210](#)  
[950CQW5H-F](#) [SBDC3470AA10J](#) [SCD105K122A3-22](#) [2N3155](#) [A571EH331M450A](#) [FKP1-2202KV5P15](#) [FKS3-680040010P10](#)  
[QXL2E473KTPT](#) [445450-1](#) [B25669A3996J375](#) [46KI322000M1M](#) [46KR415050M1K](#) [4BSNBX4100ZBFJ](#) [MKP383510063JKP2T0](#)  
[MKPY2-.02230020P15](#) [MKT 1813-368-015](#) [4055292001](#) [46KN410000N1K](#) [EEC2E106HQA405](#) [EEC2G205HQA402](#) [EEC2G805HQA415](#)  
[P409CP224M250AH470](#) [82EC2150DQ50K](#)