



**ProLight PACD-40FxL-xCGP**  
**40W COB Light-Engine LEDs**  
**Technical Datasheet**  
**Version: 1.3**

# ProLight Opto ® ProEngine Series

## Features

- High flux density of lighting source
- Good color uniformity
- RoHS compliant
- Energy Star binning structure, neutral white and warm white with 3 steps guarantee.
- More energy efficient than incandescent and most halogen lamps
- No UV
- Long lifetime
- 5 year warranty

## Main Applications

- Par lighting
- LED Bulb
- Ceiling lighting
- Spot lighting
- Down lighting

## Introduction

- The input power is 40 Watt, the multi-chip ultra high power ProEngine Series delivers never before seen luminous flux output from a single emitter. The superficial illuminating nature of ProEngine makes them the preference in Par lighting, typical applications include commercial down lighting, LED bulb, accent lighting, ceiling lighting and spot lighting.

## Emitter Mechanical Dimensions

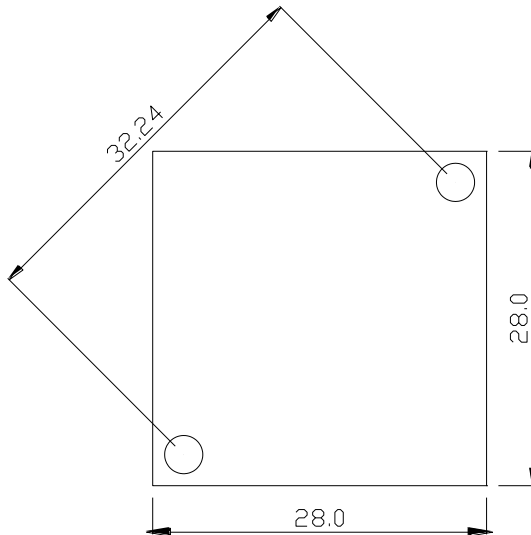
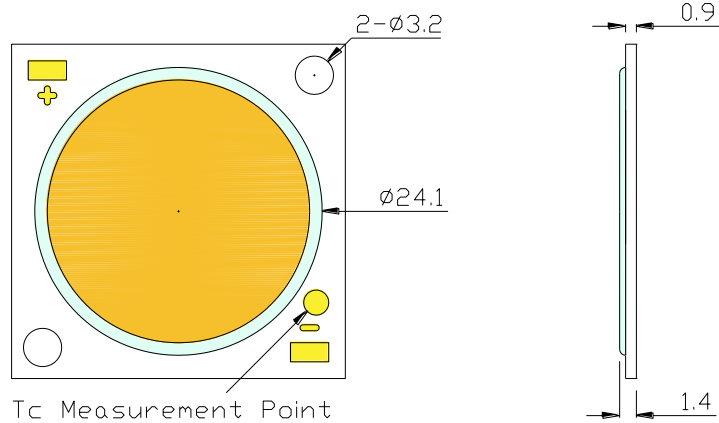

### Notes:

1. Slots in aluminum-core PCB for M3 mounting screw.
2. Solder pads are labeled "+" and "-" to denote positive and negative, respectively.
3. Drawing not to scale.
4. All dimensions are in millimeters.
5. Unless otherwise indicated, tolerances are  $\pm 0.30\text{mm}$ .
6. **Please do not use a force of over 0.3kgf impact or pressure on the lens of the LED, otherwise it will cause a catastrophic failure.**

\*The appearance and specifications of the product may be modified for improvement without notice.

## Flux Characteristics, $T_c = 25^\circ\text{C}$

Radiation Pattern	Color	Part Number COB	DC Forward Current (mA)	Luminous Flux $\Phi_v$ (lm)		CRI Minimum
				Minimum	Typical	
Lambertian	White	PACD-40FWL-BCGP	1080*	5250	5830	80
			2160	9450	10500	
	Neutral White	PACD-40FNL-BCGP	1080*	5200	5780	80
			2160	9350	10400	
	Warm White	PACD-40FVL-BCGP	1080*	4730	5520	80
			2160	8500	9940	
PACD-40FVL-DCGP		1080*	3430	4000	93	
		2160	6150	7200		

- The mark "\*" indicated product is tested and binned at the specified drive current.
- ProLight maintains a tolerance of  $\pm 7\%$  on flux and power measurements.
- ProLight maintains a tolerance of  $\pm 2$  on CRI measurements.
- Please do not drive at rated current more than 1 second without proper heat sink.

## Electrical Characteristics at 1080mA, $T_c = 25^\circ\text{C}$

Color	Forward Voltage $V_F$ (V)			Thermal Resistance Junction to Board ( $^\circ\text{C}/\text{W}$ )
	Min.	Typ.	Max.	
White	33.0	35.5	38.0	0.6
Neutral White	33.0	35.5	38.0	0.6
Warm White	33.0	35.5	38.0	0.6

- ProLight maintains a tolerance of  $\pm 1\text{V}$  for Voltage measurements.

## Optical Characteristics at 1080mA, $T_c = 25^\circ\text{C}$

Radiation Pattern	Color	Color Temperature CCT			Total included Angle (degrees)	Viewing Angle (degrees)
		Min.	Typ.	Max.	$\theta_{0.90V}$	$2\theta_{1/2}$
Lambertian	White	4740 K	5000 K	5310 K	160	120
	Neutral White	3840 K	4000 K	4130 K	160	120
		2650 K	2700 K	2800 K	160	120
	Warm White	2860 K	2940 K	3020 K	160	120
		2960 K	3000 K	3130 K	160	120

- ProLight maintains a tolerance of  $\pm 5\%$  for CCT measurements.

## Electro-Optical Characteristics, $T_j = 25^\circ\text{C}$

$I_F$ (mA)	$V_F$ (V)	Power (W)	PACD-40FWL-BCGP Flux (lm)	PACD-40FNL-BCGP Flux (lm)
640	34.23	21.91	3651	3620
800	34.72	27.78	4470	4432
960	35.18	33.78	5266	5221
1080	35.50	38.34	5830	5780
1280	36.04	46.14	6778	6720
1440	36.44	52.48	7497	7433
1600	36.84	58.94	8193	8122
1760	37.21	65.48	8874	8798
1920	37.57	72.14	9528	9446
2160	38.09	82.28	10476	10386

$I_F$ (mA)	$V_F$ (V)	Power (W)	PACD-40FNL-BCGP Flux (lm)	PACD-40FVL-DCGP Flux (lm)
640	34.23	21.91	3457	2505
800	34.72	27.78	4233	3067
960	35.18	33.78	4986	3613
1080	35.50	38.34	5520	4000
1280	36.04	46.14	6418	4651
1440	36.44	52.48	7098	5144
1600	36.84	58.94	7757	5621
1760	37.21	65.48	8402	6089
1920	37.57	72.14	9021	6537
2160	38.09	82.28	9918	7187

● All values are reference only.

## Absolute Maximum Ratings

Parameter	White/Neutral White/Warm White
Max DC Forward Current (mA)	2160
Peak Pulsed Forward Current (mA)	3240 (less than 1/10 duty cycle@1KHz)
ESD Sensitivity (HBM per MIL-STD-883E Method 3015.7)	±2000V
LED Junction Temperature	120°C
Operating Board Temperature at Maximum DC Forward Current	-40°C - 90°C
Storage Temperature	-40°C - 120°C
Reverse Voltage	Not designed to be driven in reverse bias

## Color Bin

### White Binning Structure Graphical Representation

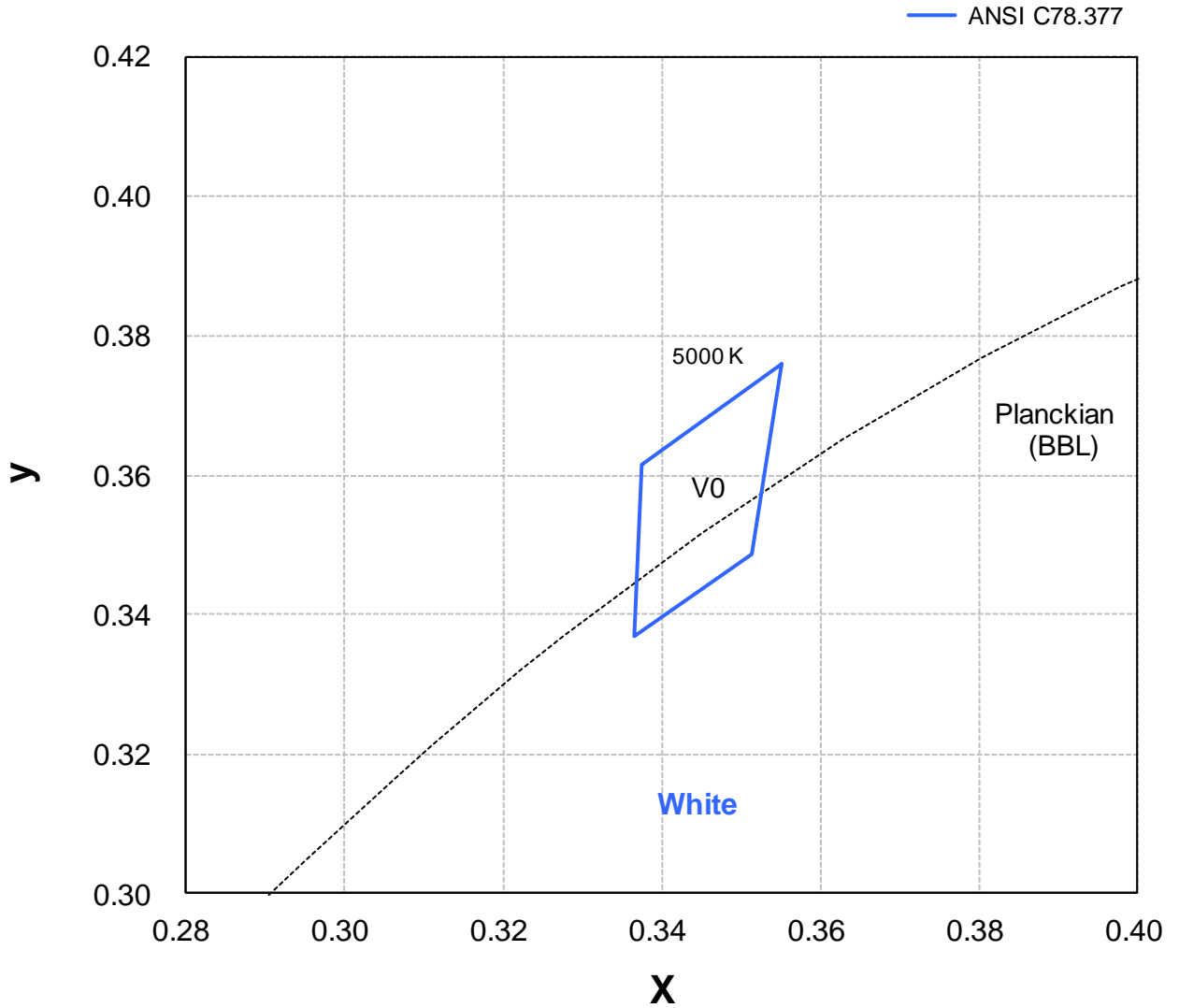

#### White Bin Structure

Bin Code	x	y	Typ. CCT (K)
V0	0.3551	0.3760	5000
	0.3376	0.3616	
	0.3366	0.3369	
	0.3515	0.3487	

- Tolerance on each color bin (x , y) is  $\pm 0.005$

## Color Bin

### Neutral White Binning Structure Graphical Representation

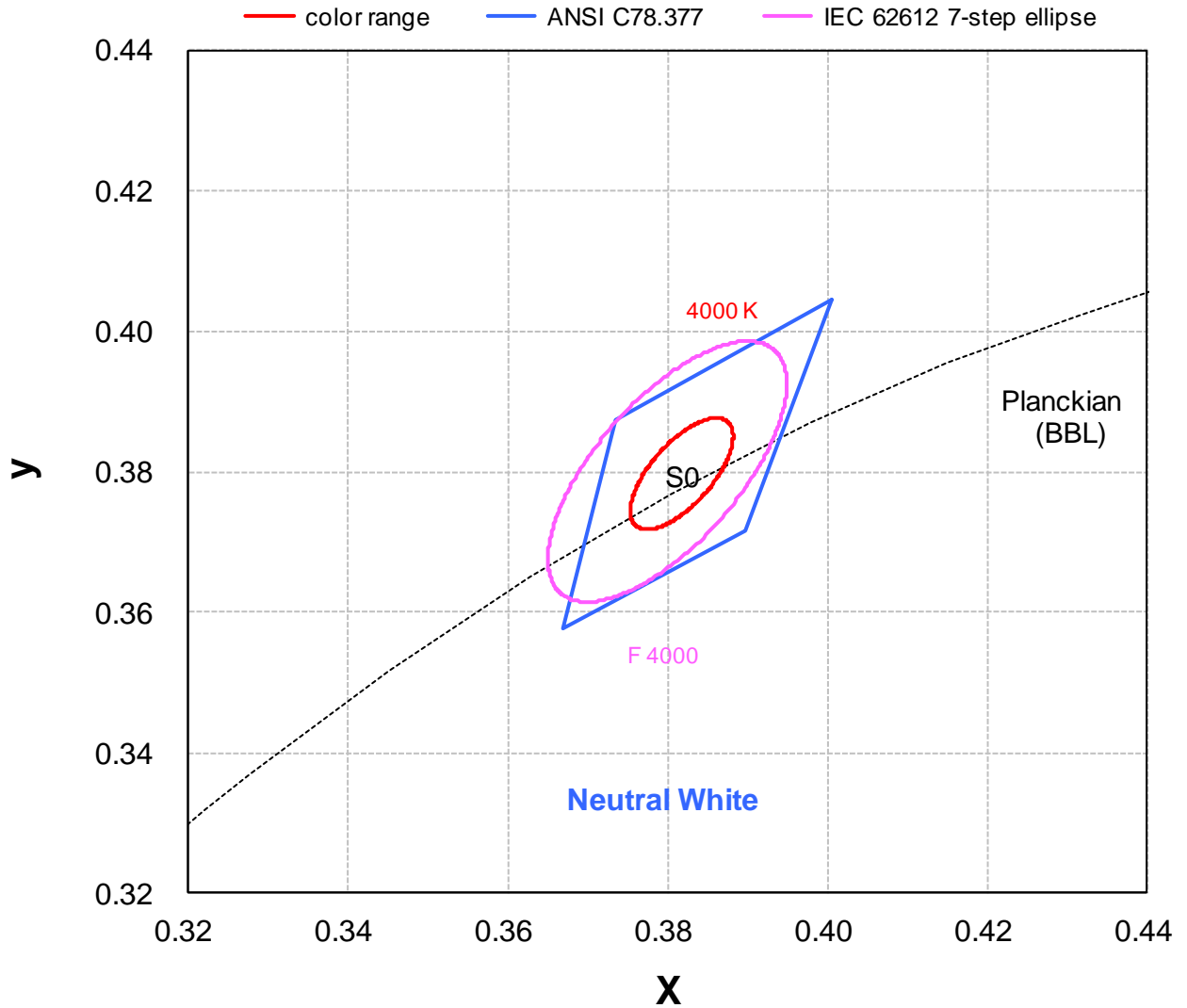

#### Neutral White Bin Structure

Bin Code	Center	Oval parameter	Typ. CCT (K)
S0	x	a	4000
	y	b	
		$e^\circ$	

- Color range stay within MacAdam "3-step" ellipse from the chromaticity center.
- The chromaticity center refers to ANSI C78.377.
- Tolerance on each color bin (x , y) is  $\pm 0.005$

## Color Bin

### Warm White Binning Structure Graphical Representation

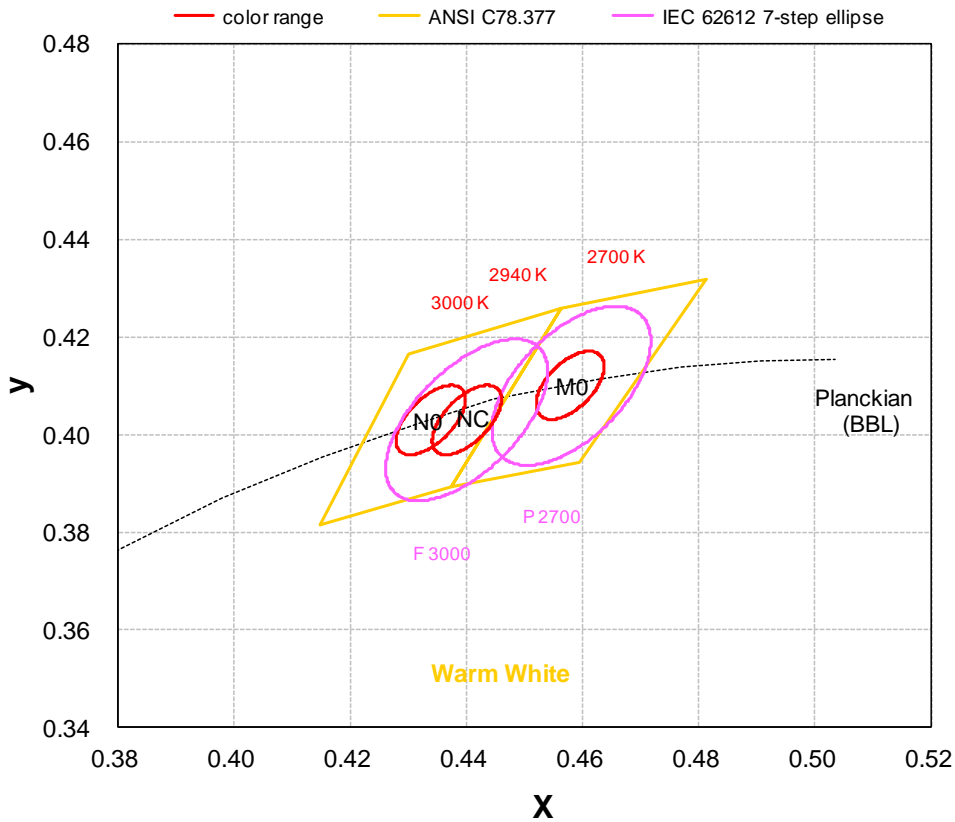

#### Warm White Bin Structure

Bin Code	Center	Oval parameter	Typ. CCT (K)	Bin Code	Center	Oval parameter	Typ. CCT (K)
M0	x 0.4578 y 0.4101	a 0.00810 b 0.00420 e° 53.70	2700	N0	x 0.4338 y 0.4030	a 0.00834 b 0.00408 e° 53.22	3000

- Color range stay within MacAdam “3-step” ellipse from the chromaticity center.
- The chromaticity center refers to ANSI C78.377.
- Tolerance on each color bin (x , y) is  $\pm 0.005$

Bin Code	Center	Oval parameter	Typ. CCT (K)
NC	x 0.4400 y 0.4030	a 0.00834 b 0.00408 e° 53.02	2940

- Color range stay within MacAdam “3-step” ellipse from the chromaticity center.
- The chromaticity center refers to IEC 62612.
- Tolerance on each color bin (x , y) is  $\pm 0.005$



## Color Spectrum, $T_c = 25^\circ\text{C}$

### 1. White

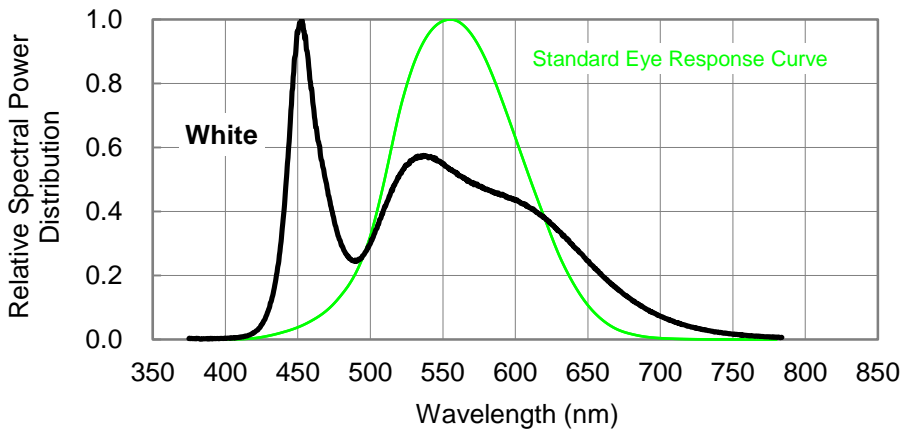

### 2. Neutral White

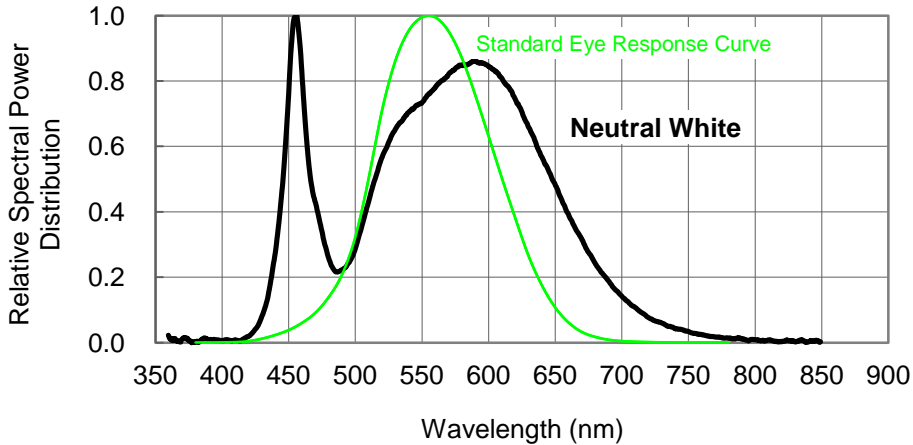

### 3. Warm White

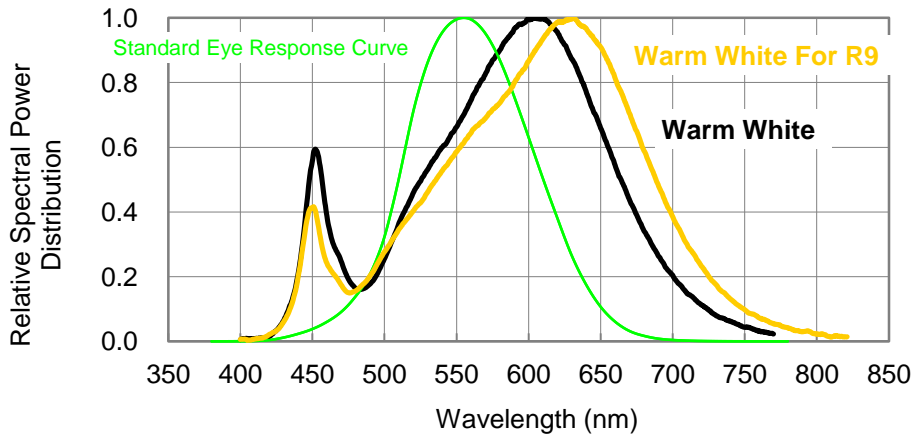

## Case Temperature Relative Characteristics

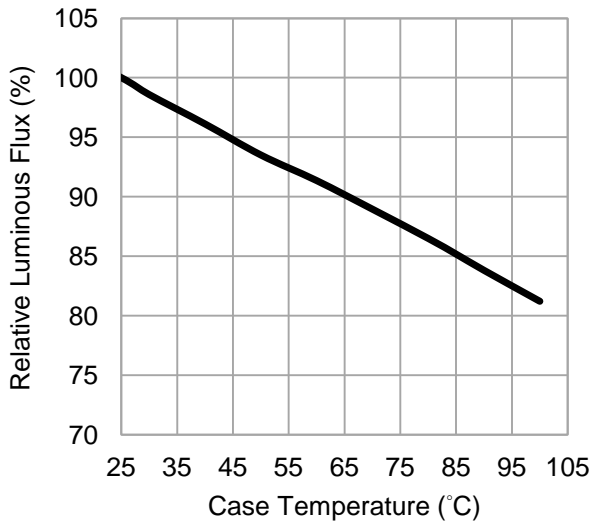

Fig 1. Case Temperature vs. Relative Luminous Flux at 1080mA.

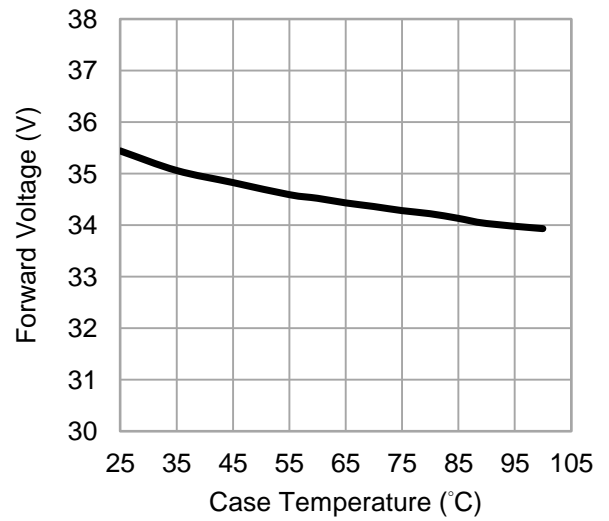

Fig 2. Case Temperature vs. Forward Voltage at 1080mA.

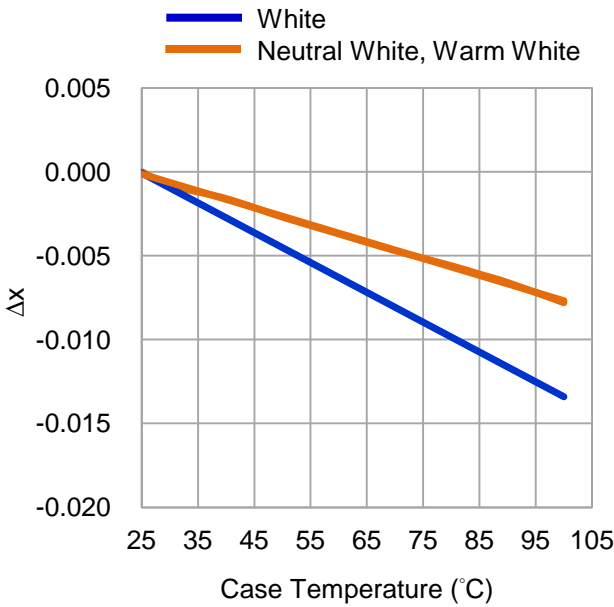

Fig 3. Case Temperature vs. Chromaticity Coordinate  $\Delta x$  at 1080mA.

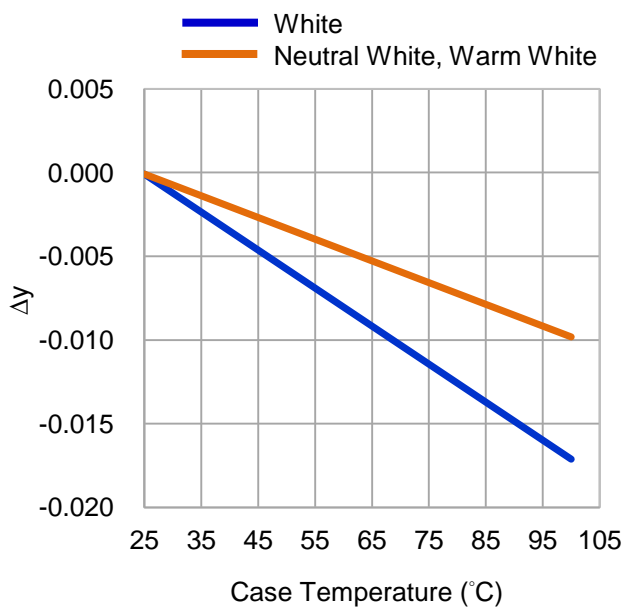

Fig 4. Case Temperature vs. Chromaticity Coordinate  $\Delta y$  at 1080mA.

## Forward Current Relative Characteristics

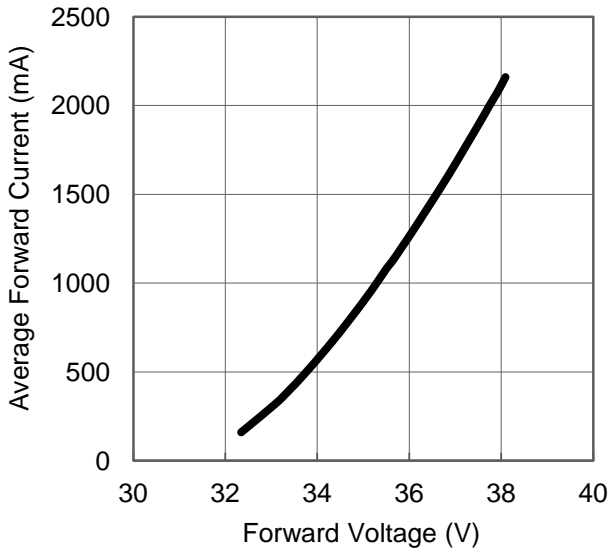

Fig 5. Forward Current vs. Forward Voltage at  $T_C=25^\circ\text{C}$ .

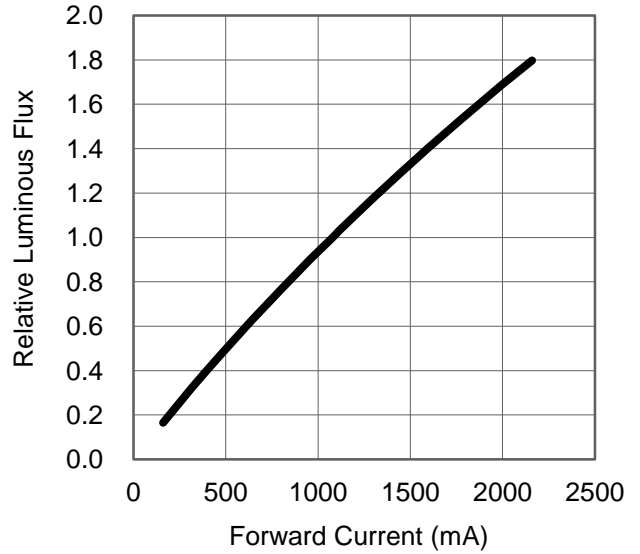

Fig 6. Forward Current vs. Relative Luminous Flux at  $T_C=25^\circ\text{C}$ .

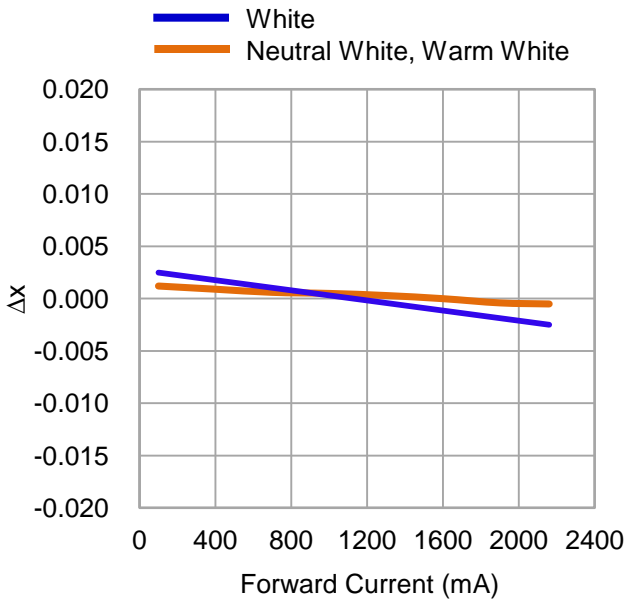

Fig 7. Forward Current vs. Chromaticity Coordinate  $\Delta x$  at  $T_C=25^\circ\text{C}$ .

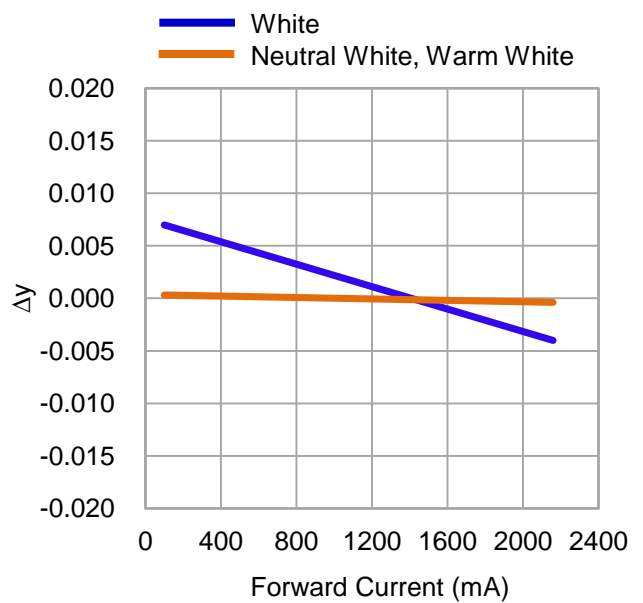

Fig 8. Forward Current vs. Chromaticity Coordinate  $\Delta y$  at  $T_C=25^\circ\text{C}$ .

## Case Temperature vs. Junction Temperature Characteristics

T <sub>c</sub> (°C)	T <sub>j</sub> (°C)	
	1080 (mA)	2160 (mA)
0	23	50
5	28	55
10	33	60
15	38	65
20	43	70
25	48	75
30	53	80
35	58	85
40	63	90
45	68	95
50	73	100
55	78	105
60	83	110
65	88	115
70	93	120
75	98	125
80	103	130

Fig 9. Case Temperature vs. Junction Temperature at 1080 · 2160mA.

# Color Coordinate vs. Forward Current, $T_c = 25^\circ\text{C}$

White Binning Graphical Representation

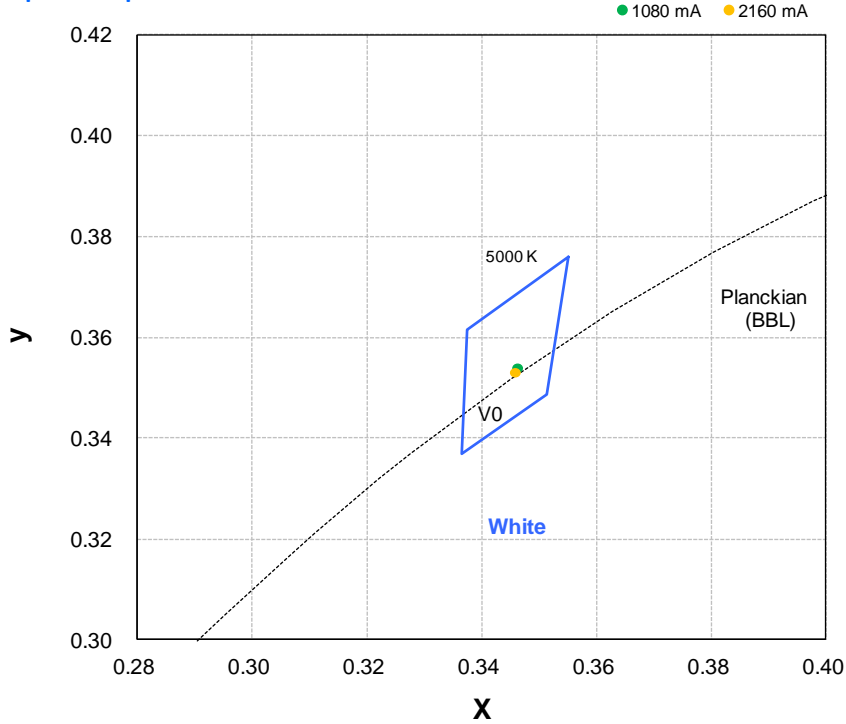

Neutral White Binning Graphical Representation

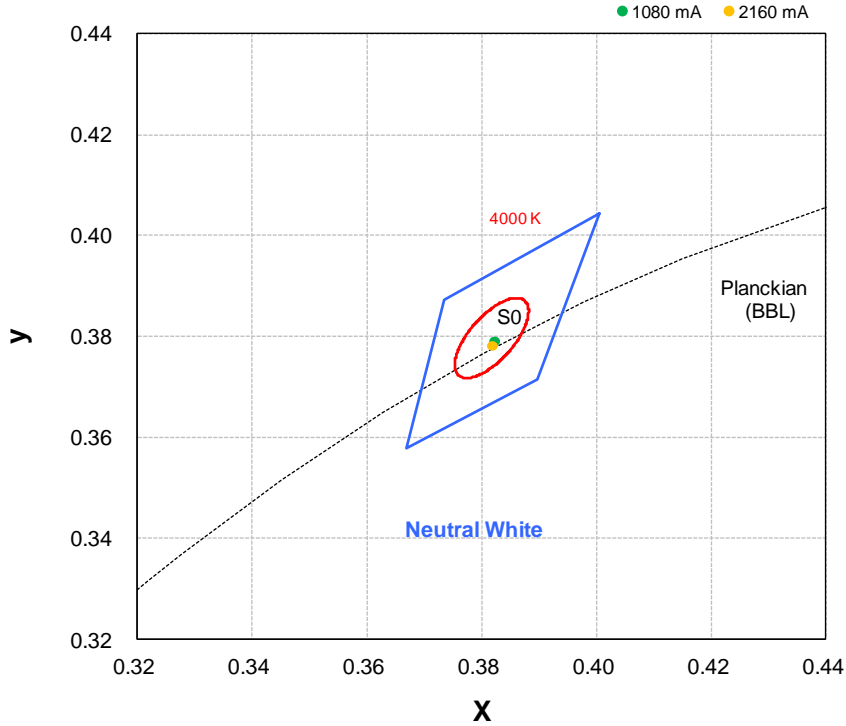

## Color Coordinate vs. Forward Current, $T_c = 25^\circ\text{C}$

### Warm White Binning Graphical Representation

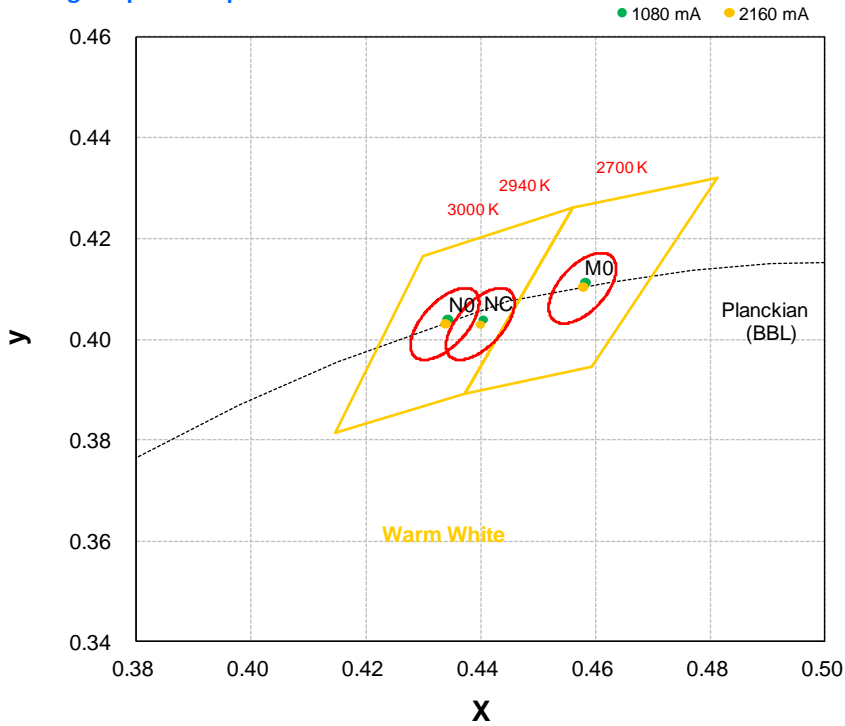

## Typical Representative Spatial Radiation Pattern

### Lambertian Radiation Pattern

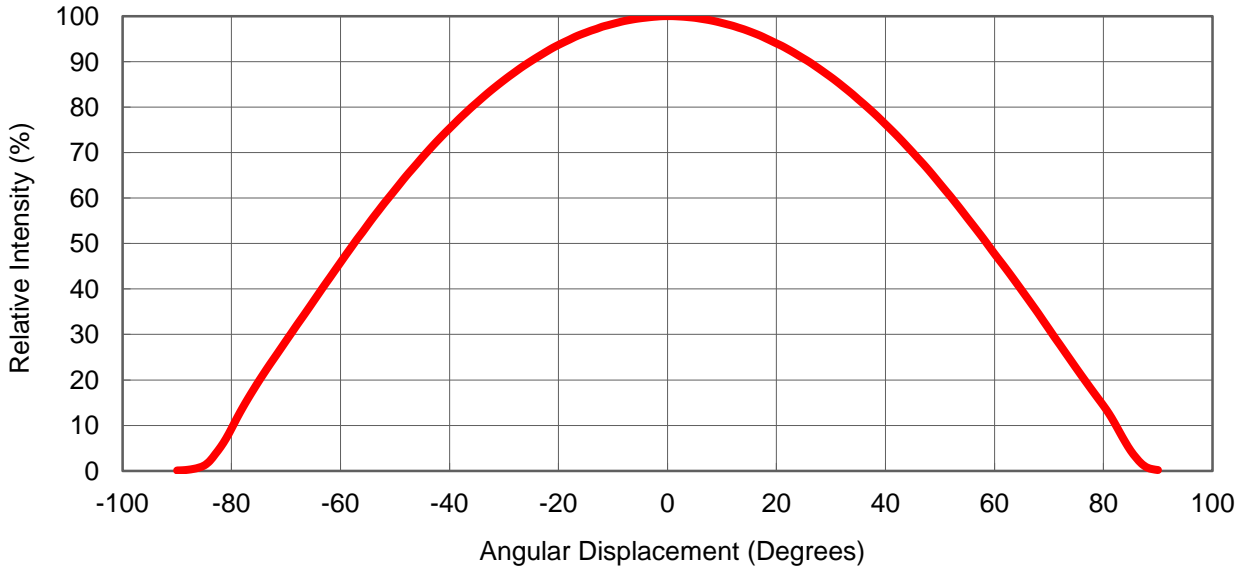

### Polar Radiation Pattern

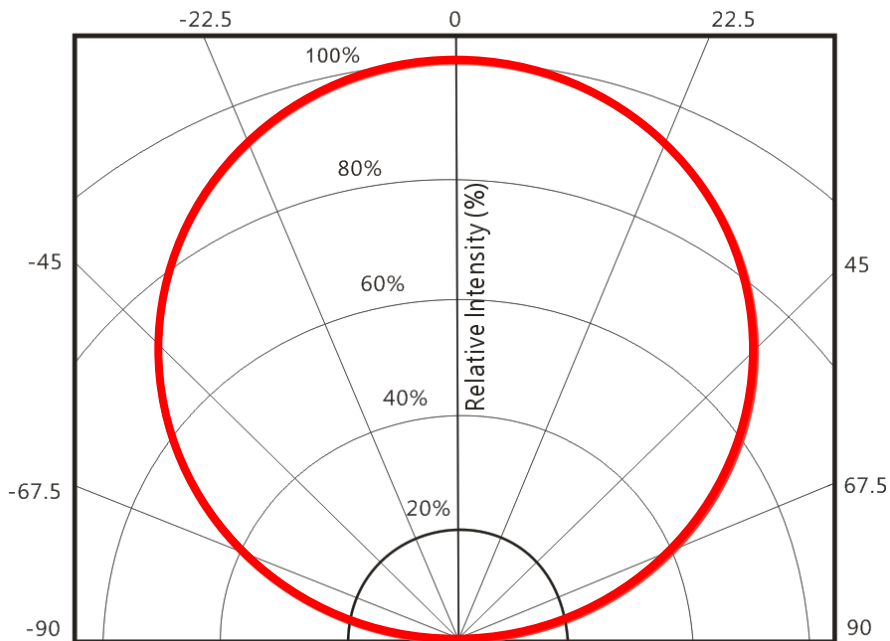

## Packing Specifications

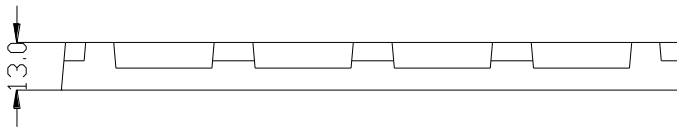
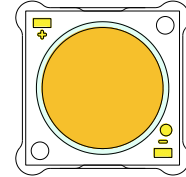
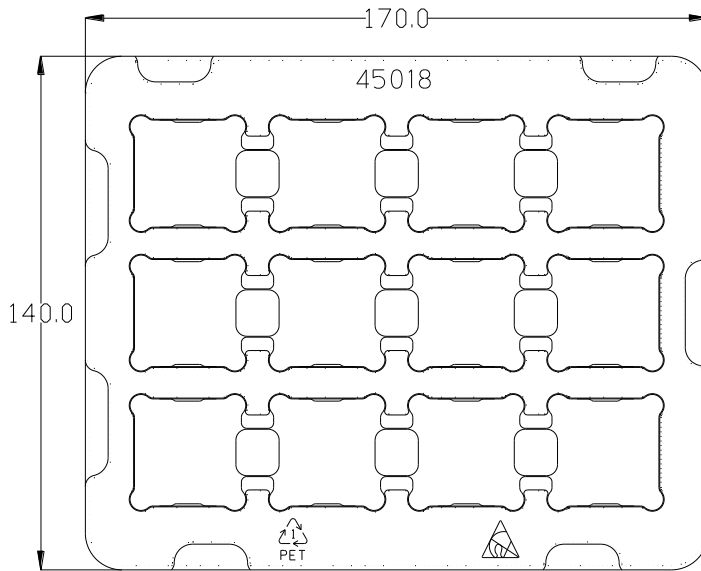

Product 12 pcs/tray

**Notes:**

1. Drawing not to scale.
2. All dimensions are in millimeters.
3. Unless otherwise indicated, tolerances are  $\pm 0.20\text{mm}$ .



## Assembly note

Regarding the high power density of LED Array, it is strongly recommend to use thermal grease and screws.

In order to reduce thermal resistance at assembly, it is necessary to use TIM (thermal interface Material) uniformly and tighten screws on heatsink, otherwise the bad thermal resistance may cause the packages **burned out**.

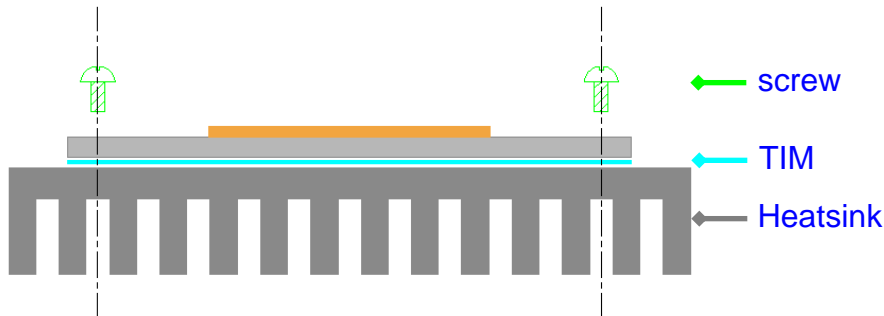

Fig 10. Reference assembly as fixing with screws

## Limited Warranty : COB Light Engine Series

This limited warranty is provided by ProLight Opto described below (“Seller”) to you as the original purchaser of the LED lighting product that is identified on Seller’s invoice reflecting its original purchase (the “Product”). We warrant the identification as such on the invoice, will be free of defects in material and workmanship for a period of five (5) YEARS from the date of original purchase. This limited warranty excludes field labor and service charges related to the repair or replacement of the Product. Seller’s aggregate liability with respect to a defective product shall in any event be limited to the monies paid to seller for that defective product. The determination of whether the Product is defective shall be made by Seller in its sole discretion with consideration given to the overall performance of the Product. This limited warranty cannot be transferred to subsequent purchasers of the Product, provided that such Product is resold in new condition and in its original packaging. This limited warranty is void if the product is not used for the purpose for which it is designed.

## Recommended Soldering Condition

- Please use lead free and “no clean ” solders.
- Soldering shall be implemented using a soldering tip at a temperature lower than 350 °C , and shall be finished within 3.5 seconds for each pad.
- During the soldering process, put the LEDs on materials whose conductivity is poor enough not to radiate heat of soldering.
- Properly solder tin wires before soldering them to LEDs.
- Avoid touching the silicone lens with the soldering iron.
- Please prevent flux from touching to the silicone lens.
- Please solder evenly on each pad.
- Contacts number of a soldering tip should be within twice for each pad.
- Next process of soldering should be carried out after the LEDs have return to ambient temperature.

\*ProLight cannot guarantee if usage exceeds these recommended conditions.

Please use it after sufficient verification is carried out on your own risk if absolutely necessary.

## Precaution for Use

- The modules light output are intense enough to cause injury to human eyes if viewed directly. Precautions must be taken to avoid looking directly at the modules with unprotected eyes.
- The modules are sensitive to electrostatic discharge. Appropriate ESD protection measures must be taken when working with the modules. Non-compliance with ESD protection measures may lead to damage or destruction of the product.
- Chemical solvents or cleaning agents must not be used to clean the modules. Mechanical stress on the Emitters must be avoided. It is best to use a soft brush, damp cloth or low-pressure compressed air.
- The products should be stored away from direct light in dry location.
- The appearance, specifications and flux bin of the product may be modified for improvement without notice. Please refer to the below website for the latest datasheets.  
<http://www.prolightopto.com/>

## Handling of Silicone Lens LEDs

Notes for handling of silicone lens LEDs

- Please do not use a force of over 0.3kgf impact or pressure on the silicone lens, otherwise it will cause a catastrophic failure.
- Avoid touching the silicone lens and the optical area of the COB Array especially by sharp tools such as Tweezers
- Avoid touching the silicone lens especially by sharp tools such as Tweezers.
- Avoid leaving fingerprints on the silicone lens.
- Please store the LEDs away from dusty areas or seal the product against dust.
- Please do not mold over the silicone lens with another resin. (epoxy, urethane, etc)

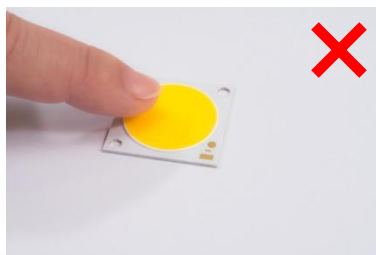

## X-ON Electronics

Largest Supplier of Electrical and Electronic Components

*Click to view similar products for [High Power LEDs - White category:](#)*

*Click to view products by [Prolight manufacturer:](#)*

Other Similar products are found below :

[G42180-08](#) [B42180-08](#) [STW8Q2PA-R5-HA](#) [SZ5-M1-W0-00-V3/W2-AA](#) [LTPL-P00DWS57](#) [LZP-D0WW00-0000](#) [CLM-9-30-90-36-AC32-F4-3](#) [SZ5-M1-WW-C8-V1/V3-FA](#) [BXRC-27E2000-D-73](#) [BXRC-27G2000-D-73](#) [BXRC-30E1000-D-73](#) [BXRC-30G2000-D-73](#) [BXRC-40E1000-D-73](#) [BXRE-30G2000-B-73](#) [BXRE-30G2000-C-73](#) [BXRE-50C2001-C-74](#) [CXM-22-27-80-54-AC30-F4-3](#) [XHP50B-00-0000-0D0UH245G](#) [XHP50B-00-0000-0D0UH240G](#) [XHP50B-00-0000-0D0UG227H](#) [XHP50B-00-0000-0D0HJ245G](#) [MP-5050-8100-27-80](#) [MP-5050-6100-65-80](#) [MP-5050-6100-50-80](#) [MP-5050-6100-40-80](#) [MP-5050-6100-30-80](#) [CXM-22-30-80-54-AC30-F4-3](#) [LTW-2835SZK57](#) [BXEM-50C0000-0-000](#) [WW-WNA30TS-U1\(M1\)](#) [KW CSLPM2.CC-8L8M-4L8N](#) [KW CSLPM2.CC-8L8M-4O9Q](#) [KW DPLS32.SB-6H6J-E5P7-EG-Z264](#) [L1V1-507003V500000](#) [CXM-22-35-80-36-AC10-F3-3](#) [KW3 CGLNM1.TG-Z6QF6-EBVFFCBB46-DFGA](#) [JB5630AWT-H-H65EA0000-NZ000001](#) [XHP50B-00-0000-0D0UG430H](#) [CXM-22-35-90-54-AC40-F5-3](#) [CXM-22-35-80-54-AC40-F5-3](#) [OSM51206E1N-0.8T](#) [OSW43020C1C](#) [MP161611032290](#) [MP-1616-2103-50-90](#) [KW CULPM1.TG-Z6RF7-ebvFfcbB46-65G5](#) [KW DMLS33.SG-Z6M7-EBVFFCBB46-8E8G-700-S](#) [XPGDWT-B1-0000-00EEA](#) [XHP70B-00-0000-0D0BP450E](#) [KW DMLN33.SG-7J7K-EBVFFCBB46-8E8G-200-S](#) [ASMT-MW05-NMNS1](#)