

# CAT6241

## 1 Amp Adjustable CMOS LDO Voltage Regulator

### Description

The CAT6241 is a low dropout CMOS voltage regulator providing up to 1000 mA of output current with fast response to load current and line voltage changes. CAT6241 offers a user adjustable output voltage from 0.5 V to 5.0 V and its low quiescent current make CAT6241 ideal for energy conscious designs. CAT6241 is available in space saving 2 mm x 2 mm UDFN-8 and 3 mm x 3 mm WDFN-6 packages, each with a power pad for heat sinking to the PCB.

### Features

- Guaranteed 1000 mA Continuous Output Current
- $V_{OUT}$ : 0.5 V to 5.0 V, Minimum  $V_{IN}$ : 1.6 V
- Dropout Voltage of 350 mV Typical at 1000 mA
- $\pm 2.0\%$  Output Voltage Accuracy at Room Temperature
- No-load Ground Current of 70  $\mu$ A Typical
- Full-load Ground Current of 140  $\mu$ A Typical
- “Zero” Current Shutdown Mode
- Under Voltage Lockout
- Stable with Ceramic Output Capacitors
- Current Limit and Thermal Protection
- 2 mm x 2 mm UDFN-8 and 3 mm x 3 mm WDFN-6 Packages
- These Devices are Pb-Free, Halogen Free/BFR Free and are RoHS Compliant

### Typical Applications

- DSP Core and I/O Voltages
- FPGAs, ASICs
- PDAs, Mobile Phones, GPS
- Camcorders and Cameras
- Hard Disk Drives



ON Semiconductor®

<http://onsemi.com>



WDFN-6  
3 x 3 mm  
CASE 511AP



UDFN-8  
2 x 2 mm  
CASE 517AW

### PIN CONNECTIONS

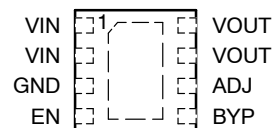
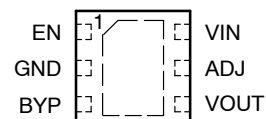

(Top Views)

### MARKING DIAGRAMS

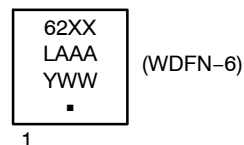

- XX = Specific Device Code
- 62XX = Specific Device Code
- L = Assembly Location Code
- AAA = Assembly Lot Number (Last Three Digits)
- Y = Production Year (Last Digit)
- M = Production Month (1-9, O, N, D)
- WW = Production Week (Two Digits)
- = Pb-Free Package

### ORDERING INFORMATION

See detailed ordering and shipping information in the package dimensions section on page 17 of this data sheet.

# CAT6241

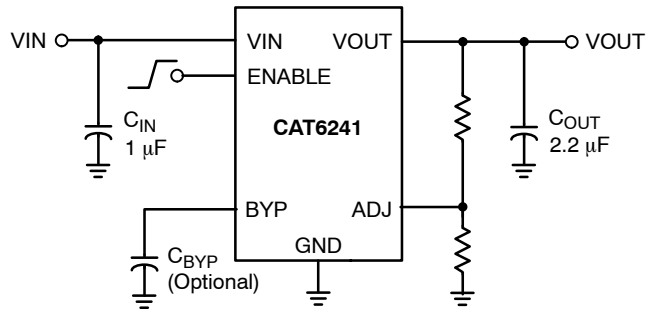

Figure 1. Application Schematic

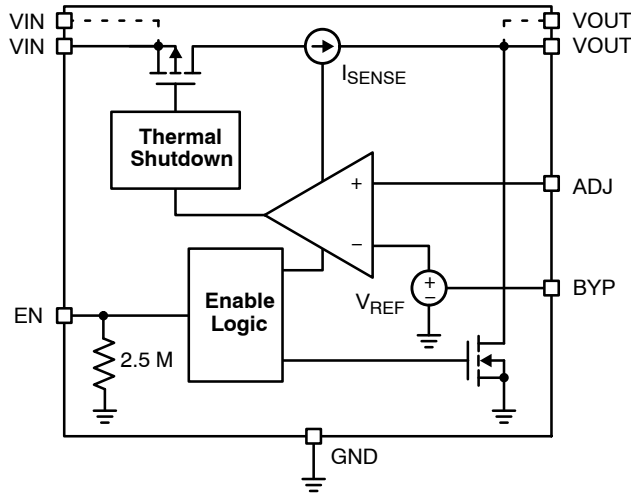

Figure 2. Simplified Block Diagram

Table 1. PIN FUNCTION DESCRIPTION

Pin # WDFN-6	Pin # UDFN-8	Pin Name	Description
1	4	EN	The Enable Input. An active HIGH input, turning ON the LDO. This input should be tied to $V_{IN}$ if the LDO is not intended to be shut off during normal operation. A pull-down 2.5 MΩ resistor maintains the circuit in the OFF state if the pin is left open.
2, PAD	3, PAD	GND	Power Supply Ground; Device Substrate. The center pad is internally connected to Ground and as such can cause short circuits to signal traces running beneath the IC. This pad is intended for heat sinking the IC to the PCB and is typically connected to the PCB ground plane.
3	5	BYP	Bypass input. Placing a capacitor of 100 pF to 470 pF between BYP and ground reduces noise on $V_{OUT}$ . This capacitor is optional.
4	7, 8	$V_{OUT}$	Regulated Output Voltage. A protection block eliminates any current flow from output to input if $V_{OUT} > V_{IN}$ . Connect both pins for specified dropout performance.
5	6	ADJ	Output Voltage Adjust Input. This input ties to the common point of a resistor divider which determines the regulator's output voltage. See Applications section for details on selecting resistor values.
6	1, 2	$V_{IN}$	Positive Power Supply Input. Supplies power for $V_{OUT}$ as well as the regulator's internal circuitry. Connect both pins for specified dropout performance.

# CAT6241

**Table 2. ABSOLUTE MAXIMUM RATINGS**

Rating	Symbol	Value	Unit
Input Voltage Range (Note 1)	$V_{IN}$	-0.3 to 6.0	V
Output Voltage Range	$V_{OUT}$	-0.3 to 6.0	V
Enable Input Range	EN	-0.3 to 5.5 V or ( $V_{IN} + 0.3$ ), whichever is lower	V
Adjust Input Range	ADJ	-0.3 to 5.5 V	V
Bypass Input Range	BYP	-0.3 to 5.5 V or ( $V_{IN} + 0.3$ ), whichever is lower	V
Power Dissipation	PD	Internally Limited	mW
Maximum Junction Temperature	$T_{J(max)}$	150	°C
Storage Temperature Range	$T_{STG}$	-65 to 150	°C
ESD Capability, Human Body Model (Note 2)	ESD <sub>HBM</sub>	2	kV
ESD Capability, Machine Model (Note 2)	ESD <sub>MM</sub>	200	V
Lead Temperature Soldering Reflow (SMD Styles Only), Pb-Free Versions (Note 3)	$T_{SLD}$	260	°C

Stresses exceeding Maximum Ratings may damage the device. Maximum Ratings are stress ratings only. Functional operation above the Recommended Operating Conditions is not implied. Extended exposure to stresses above the Recommended Operating Conditions may affect device reliability.

- Refer to ELECTRICAL CHARACTERISTICS and APPLICATION INFORMATION for Safe Operating range.
- This device series incorporates ESD protection and is tested by the following methods:  
ESD Human Body Model tested per AEC-Q100-002 (EIA/JESD22-A114)  
ESD Machine Model tested per AEC-Q100-003 (EIA/JESD22-A115)  
Latchup Current Maximum Rating:  $\leq 150$  mA per JEDEC standard: JESD78
- For information, please refer to our Soldering and Mounting Techniques Reference Manual, SOLDERRM/D

**Table 3. THERMAL CHARACTERISTICS**

Rating	Symbol	Value	Unit
Thermal Characteristics, WDFN-6, 3 x 3 mm Thermal Resistance, Junction-to-Air: 1 in <sup>2</sup> /1 oz. copper (Note 4) Thermal Reference, Junction-to-Case (Note 4)	$R_{\theta JA}$ $R_{\psi JL}$	55 10	°C/W

- Values based on copper area of 645 mm<sup>2</sup> (or 1 in<sup>2</sup>) of 1 oz copper thickness and FR4 PCB substrate.

**Table 4. OPERATING RANGES** (Note 5)

Rating	Symbol	Min	Max	Unit
Input Voltage (Note 6)	$V_{IN}$	1.6	5.5	V
Output Current	$I_{OUT}$	0.1	1000	mA
Output Voltage	$V_{OUT}$	0.5	5.0	V
Ambient Temperature	$T_A$	-40	85	°C

- Refer to ELECTRICAL CHARACTERISTICS and APPLICATION INFORMATION for Safe Operating range.
- Minimum  $V_{IN\_MIN} = 1.6$  V or ( $V_{OUT} + V_{DO}$ ), whichever is higher.

**Table 5. ELECTRICAL CHARACTERISTICS** ( $V_{IN} = (V_{OUT} + 1$  V) or  $V_{IN\_MIN}$ , whichever is higher,  $C_{IN} = 1$   $\mu$ F,  $C_{OUT} = 2.2$   $\mu$ F, for typical values  $T_A = 25$ °C, for **Bold** values  $T_A = -40$ °C to 85°C; unless otherwise noted.)

Symbol	Parameter	Conditions	Min	Typ	Max	Unit
<b>INPUT / OUTPUT</b>						
$V_{IN}$	Input Voltage		<b>1.6</b>		<b>5.5</b>	V
$V_{OUT}$	Output Voltage Range		<b>0.5</b>		<b>5.0</b>	V
$V_{OUT\_ACC}$	Output Voltage Accuracy	Initial accuracy, $I_{OUT} = 1$ mA	-2		2	%
			<b>-3</b>		<b>3</b>	
$V_{ADJ}$	Voltage at ADJ input		<b>0.485</b>	<b>0.5</b>	<b>0.515</b>	V
$TC_{OUT}$	Output Voltage Temp. Coefficient			<b>50</b>		ppm/°C
$I_{OUT}$	Output Current		0.0001	1		A

# CAT6241

**Table 5. ELECTRICAL CHARACTERISTICS** ( $V_{IN} = (V_{OUT} + 1\text{ V})$  or  $V_{IN\_MIN}$ , whichever is higher,  $C_{IN} = 1\ \mu\text{F}$ ,  $C_{OUT} = 2.2\ \mu\text{F}$ , for typical values  $T_A = 25^\circ\text{C}$ , for **Bold** values  $T_A = -40^\circ\text{C}$  to  $85^\circ\text{C}$ ; unless otherwise noted.)

Symbol	Parameter	Conditions	Min	Typ	Max	Unit
<b>INPUT / OUTPUT</b>						
$V_{R-LINE}$	Line Regulation	$V_{IN} = V_{OUT} + 1.0\text{ V}$ to $5.5\text{ V}$ , $I_{OUT} = 10\text{ mA}$	-0.3	$\pm 0.08$	0.3	%V
		$V_{IN} = V_{OUT} + 1.0\text{ V}$ to $5.5\text{ V}$ , $I_{OUT} = 10\text{ mA}$	<b>-0.45</b>		<b>0.45</b>	
$V_{R-LOAD}$	Load Regulation $V_{OUT} \geq 0.8\text{ V}$	$I_{OUT} = 100\ \mu\text{A}$ to $1000\text{ mA}$		1.5	2	%
		$I_{OUT} = 100\ \mu\text{A}$ to $1000\text{ mA}$			<b>3</b>	
$V_{DO}$	$V_{OUT} = 1.2\text{ V}$	$I_{OUT} = 300\text{ mA}$ $T_A = 25^\circ\text{C}$			460	mV
	$V_{OUT} = 2.5\text{ V}$				110	
	$V_{OUT} = 3.3\text{ V}$				85	
	$V_{OUT} = 1.2\text{ V}$	$I_{OUT} = 1\text{ A}$ $T_A = 25^\circ\text{C}$			700	
	$V_{OUT} = 2.5\text{ V}$				350	
	$V_{OUT} = 3.3\text{ V}$				275	
$I_{ADJ}$	ADJ Input Current				100	nA
$I_{GND}$	Ground Current	$I_{OUT} = 0\ \mu\text{A}$		70		$\mu\text{A}$
		$I_{OUT} = 0\ \mu\text{A}$			<b>100</b>	
		$I_{OUT} = 1000\text{ mA}$		140	200	
		$I_{OUT} = 1000\text{ mA}$			<b>250</b>	
$I_{GND-SD}$	Shutdown Ground Current	$V_{EN} < 0.4\text{ V}$			<b>5</b>	$\mu\text{A}$
ISC	Output short circuit current limit	$V_{OUT} = 0\text{ V}$		900		mA

## PSRR AND NOISE

PSRR	Power Supply Rejection Ratio	$f = 1\text{ kHz}$ , $BYP = 470\text{ pF}$ , $I_{OUT} = 10\text{ mA}$		54		dB
		$f = 20\text{ kHz}$ , $BYP = 470\text{ pF}$ , $I_{OUT} = 10\text{ mA}$		42		
$e_N$	Output Noise Voltage for 1.2 V output	$BW = 10\text{ Hz}$ to $100\text{ kHz}$ $BYP = 470\text{ pF}$ , $I_{OUT} = 10\text{ mA}$		45		$\mu\text{V}_{rms}$

## UVLO, $R_{OUT}$ AND ESR

$V_{UVLO}$	Under voltage lockout threshold			1.4	<b>1.55</b>	V
$R_{OUT-SH}$	ON resistance of Discharge Transistor			150		$\Omega$
ESR	$C_{OUT}$ equivalent series resistance		5		500	m $\Omega$

## ENABLE INPUT

$V_{HI}$	Logic High Level	$V_{IN} = 1.6$ to $5.5\text{ V}$	<b>1.6</b>			V
$V_{LO}$	Logic Low Level	$V_{IN} = 1.6$ to $5.5\text{ V}$			<b>0.4</b>	V
$I_{EN}$	Enable Input Current	$V_{EN} = 0.4\text{ V}$		0.15	<b>1</b>	$\mu\text{A}$
		$V_{EN} = V_{IN} = 2.5\text{ V}$		1	<b>3</b>	
$R_{EN}$	Enable pull-down resistor			2.5		M $\Omega$

## TIMING

$T_{ON}$	Turn-On Time	$C_{BYP} = 0\text{ pF}$		230		$\mu\text{s}$
		$C_{BYP} = 470\text{ pF}$		1600		

## THERMAL PROTECTION

$T_{SD}$	Thermal Shutdown			145		$^\circ\text{C}$
$T_{HYS}$	Thermal Hysteresis			10		$^\circ\text{C}$

- Performance guaranteed over the indicated operating temperature range by design and/or characterization tested at  $T_J = T_A = 25^\circ\text{C}$ . Low duty cycle pulse techniques are used during testing to maintain the junction temperature as close to ambient as possible.
- Output current capability depends upon the value of both  $V_{IN}$  and  $V_{OUT}$ . For  $V_{OUT} \leq 0.8\text{ V}$ , output current capability is 90% of ISC (see Figure 13). For  $V_{OUT} > 0.8\text{ V}$ , current capability is 1 A for  $V_{IN} \geq 1.8\text{ V}$ .

# CAT6241

## TYPICAL CHARACTERISTICS

(shown for  $V_{ADJ} = V_{OUT} = 0.5\text{ V}$ ,  $V_{IN} = 1.6\text{ V}$ ,  $I_{OUT} = 1\text{ mA}$ ,  $C_{IN} = 1\text{ }\mu\text{F}$ ,  $C_{OUT} = 4.7\text{ }\mu\text{F}$ ,  $C_{BYP} = 0$ , and  $T_A = 25^\circ\text{C}$  unless otherwise specified.)

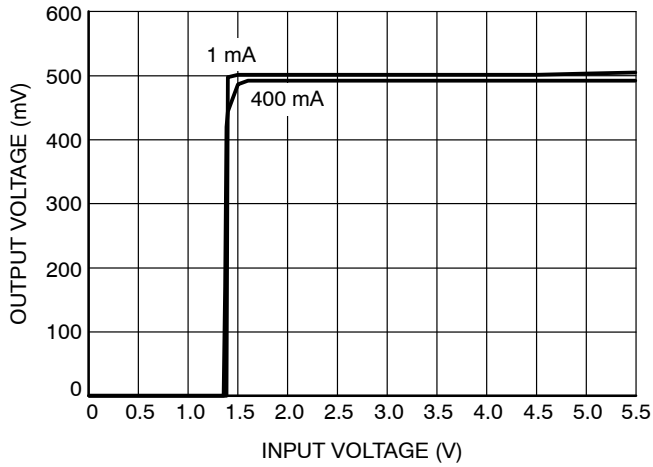

Figure 3. Dropout Characteristics

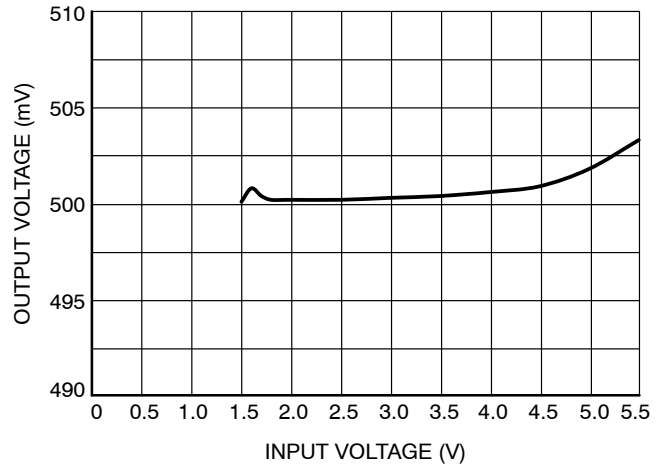

Figure 4. Line Regulation

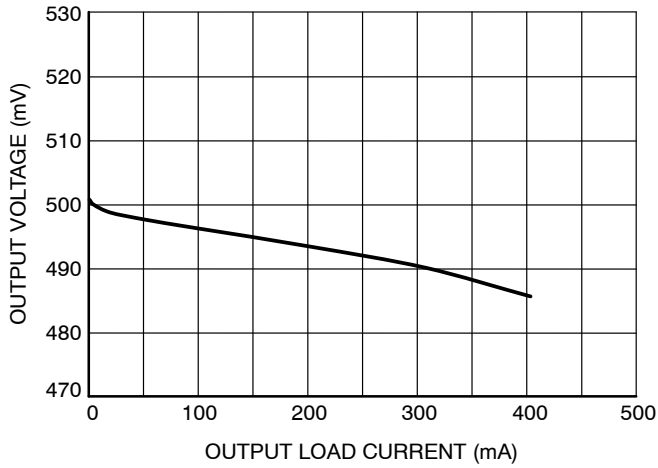

Figure 5. Load Regulation

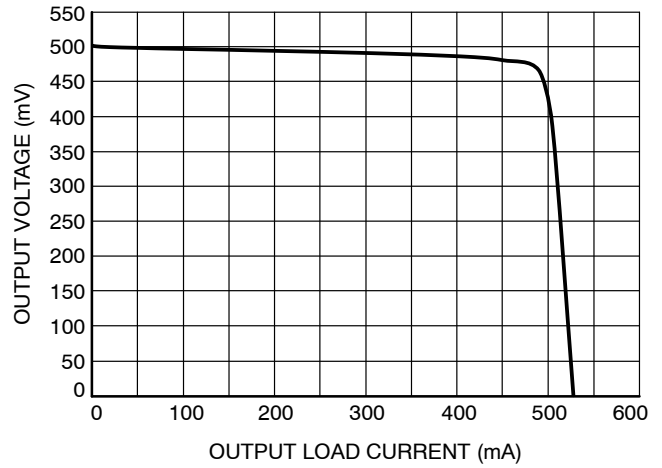

Figure 6. Output Current Capability

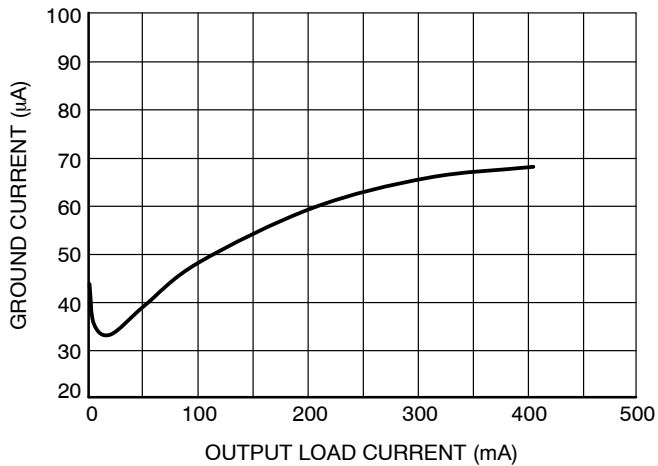

Figure 7. Ground Current vs. Load Current

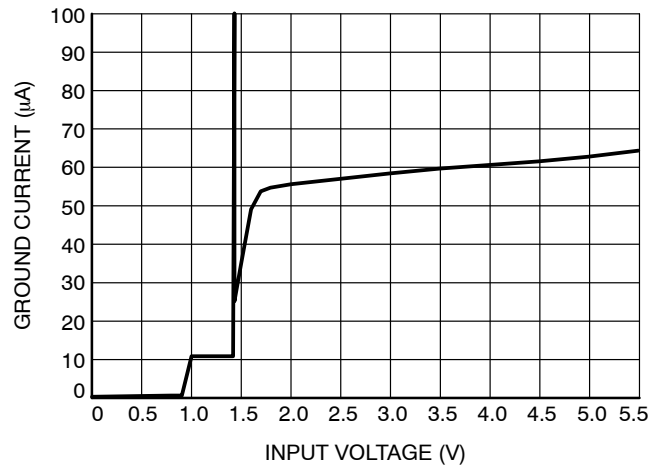

Figure 8. Ground Current vs. Input Voltage

# CAT6241

## TYPICAL CHARACTERISTICS

(shown for  $V_{ADJ} = V_{OUT} = 0.5\text{ V}$ ,  $V_{IN} = 1.6\text{ V}$ ,  $I_{OUT} = 1\text{ mA}$ ,  $C_{IN} = 1\text{ }\mu\text{F}$ ,  $C_{OUT} = 4.7\text{ }\mu\text{F}$ ,  $C_{BYP} = 0$ , and  $T_A = 25^\circ\text{C}$  unless otherwise specified.)

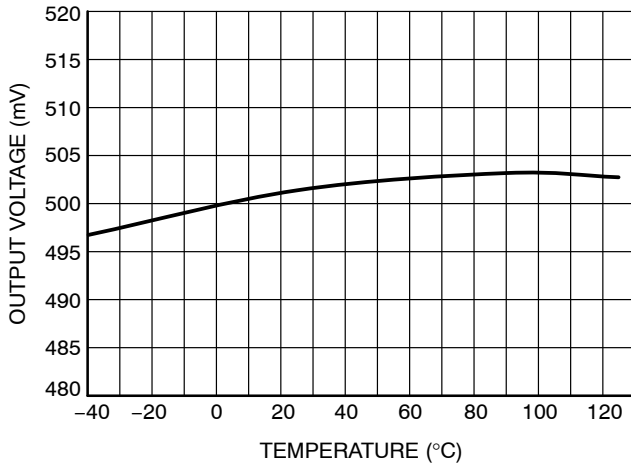

Figure 9. Output Voltage vs. Temperature

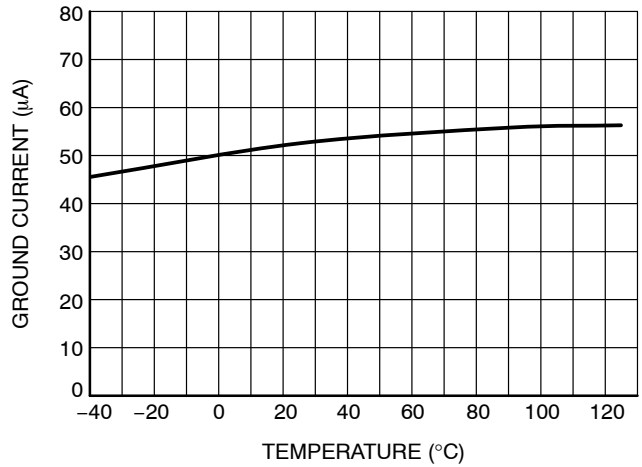

Figure 10. Ground Current vs. Temperature

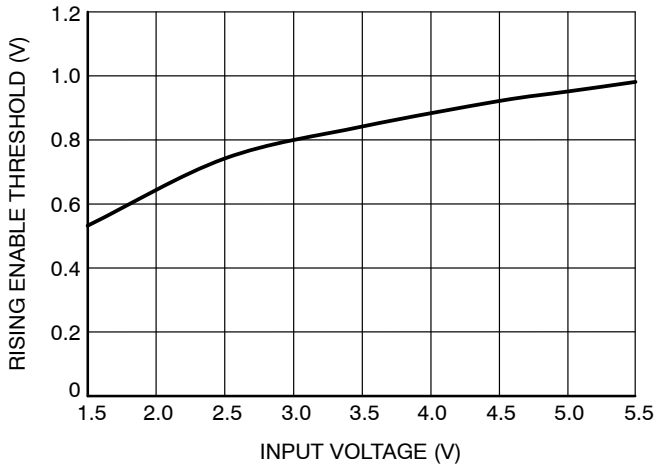

Figure 11. Rising Enable Threshold vs. Input Voltage

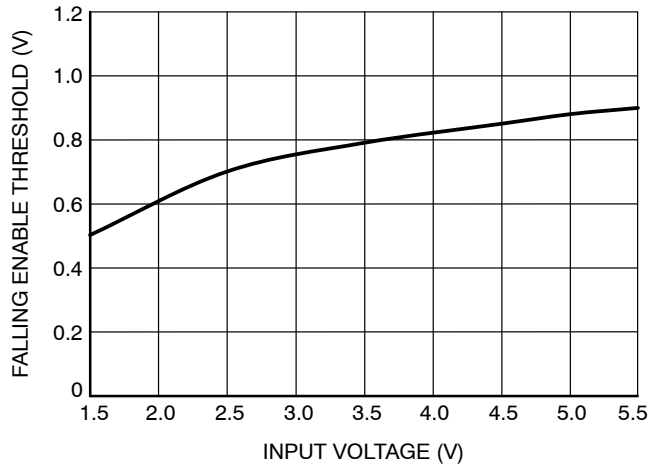

Figure 12. Falling Enable Threshold vs. Input Voltage

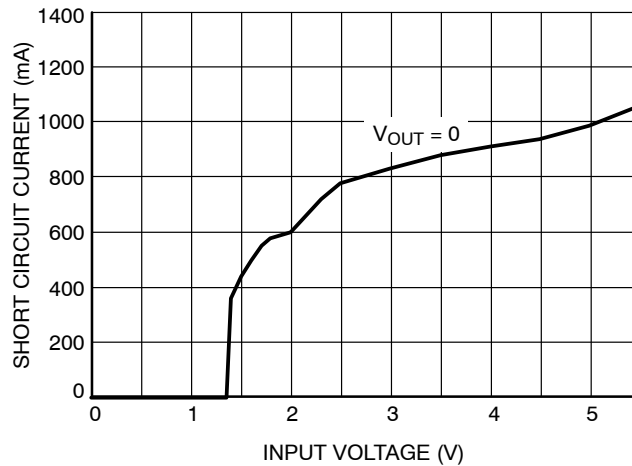

Figure 13. Output Short-circuit Current vs. Input Voltage

# CAT6241

## TRANSIENT CHARACTERISTICS

(shown for  $V_{OUT} = 0.5\text{ V}$ ,  $V_{IN} = 1.6\text{ V}$ ,  $I_{OUT} = 1\text{ mA}$ ,  $C_{IN} = 1\text{ }\mu\text{F}$ ,  $C_{OUT} = 4.7\text{ }\mu\text{F}$ ,  $C_{BYP} = 0$ , and  $T_A = 25^\circ\text{C}$  unless otherwise specified.)

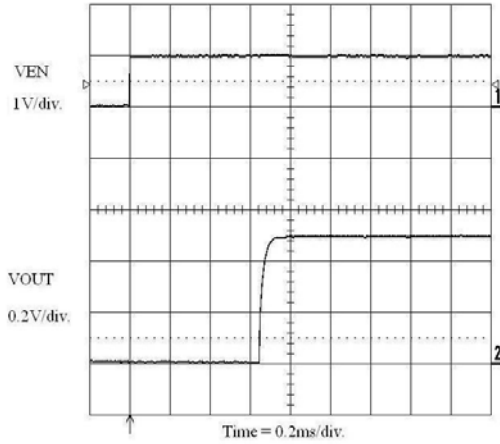

Figure 14. Enable Turn-on (1 mA Load)

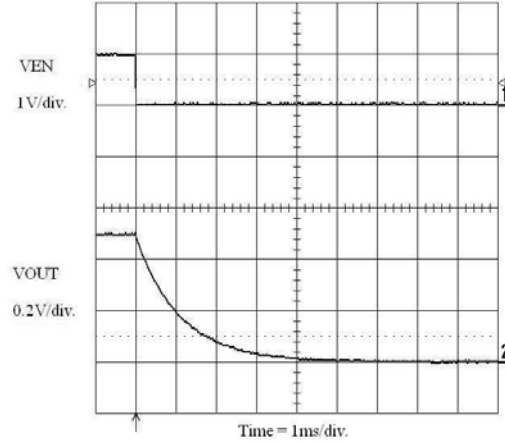

Figure 15. Enable Turn-off (1 mA Load)

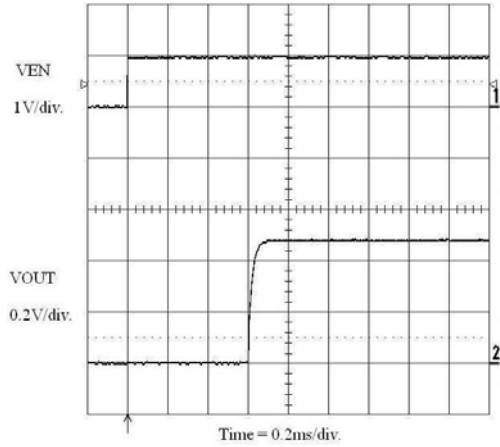

Figure 16. Enable Turn-on (350 mA Load)

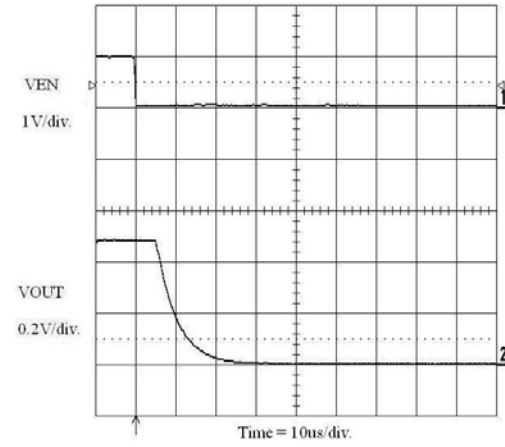

Figure 17. Enable Turn-off (350 mA Load)

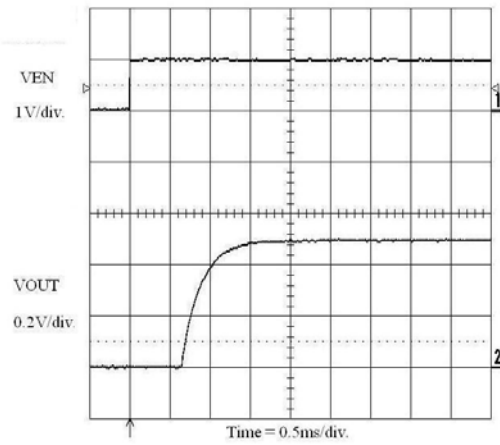

Figure 18. Enable Turn-on (1 mA Load)  
 $C_{BYP} = 470\text{ pF}$

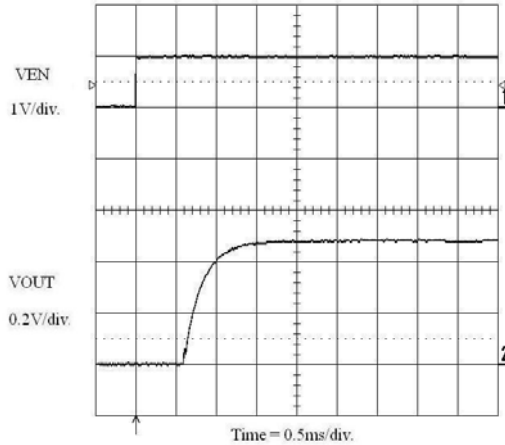

Figure 19. Enable Turn-on (350 mA Load)  
 $C_{BYP} = 470\text{ pF}$

TRANSIENT CHARACTERISTICS

(shown for  $V_{OUT} = 0.5\text{ V}$ ,  $V_{IN} = 1.6\text{ V}$ ,  $I_{OUT} = 1\text{ mA}$ ,  $C_{IN} = 1\text{ }\mu\text{F}$ ,  $C_{OUT} = 4.7\text{ }\mu\text{F}$ ,  $C_{BYP} = 0$ , and  $T_A = 25^\circ\text{C}$  unless otherwise specified.)

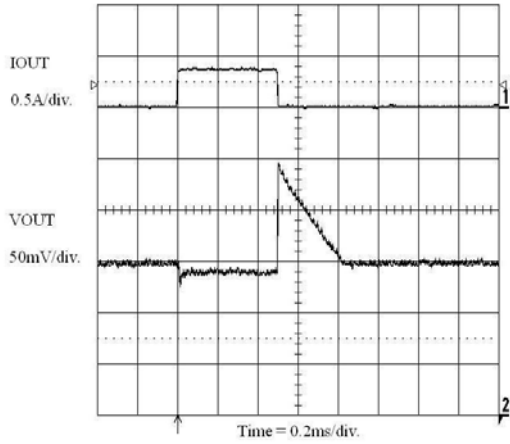

Figure 20. Load Transient Response  
(1 mA to 350 mA)

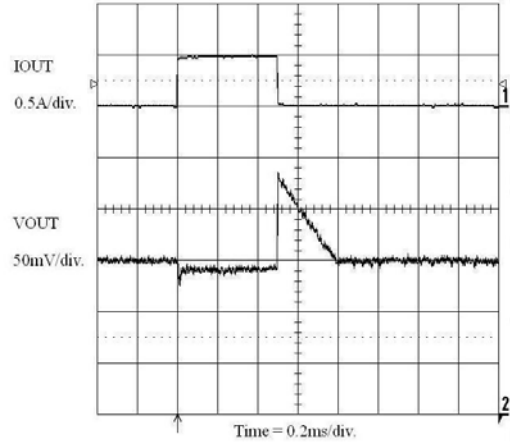

Figure 21. Load Transient Response  
(1 mA to 500 mA)  $V_{IN} = 1.8\text{ V}$

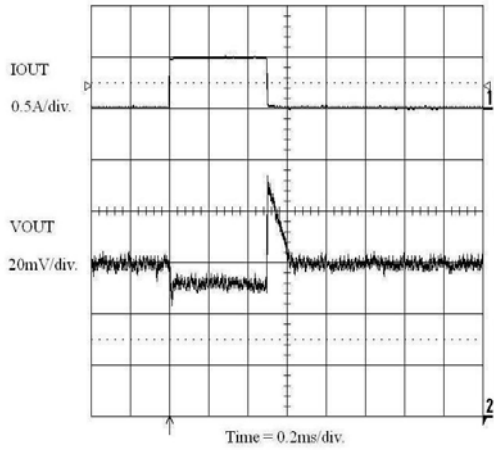

Figure 22. Load Transient Response  
(1 mA to 500 mA)  $V_{IN} = 1.9\text{ V}$

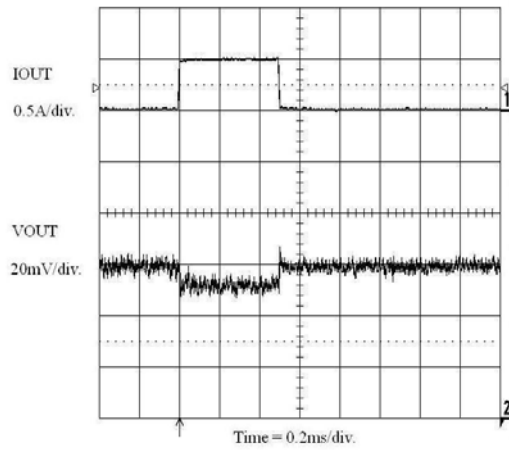

Figure 23. Load Transient Response  
(1 mA to 500 mA)  $V_{IN} = 2.0\text{ V}$



# CAT6241

## TYPICAL CHARACTERISTICS

(shown for  $V_{OUT} = 1.0\text{ V}$ ,  $V_{IN} = 2.0\text{ V}$ ,  $I_{OUT} = 1\text{ mA}$ ,  $C_{IN} = 1\text{ }\mu\text{F}$ ,  $C_{OUT} = 4.7\text{ }\mu\text{F}$ ,  $C_{BYP} = 0$ , and  $T_A = 25^\circ\text{C}$  unless otherwise specified.)

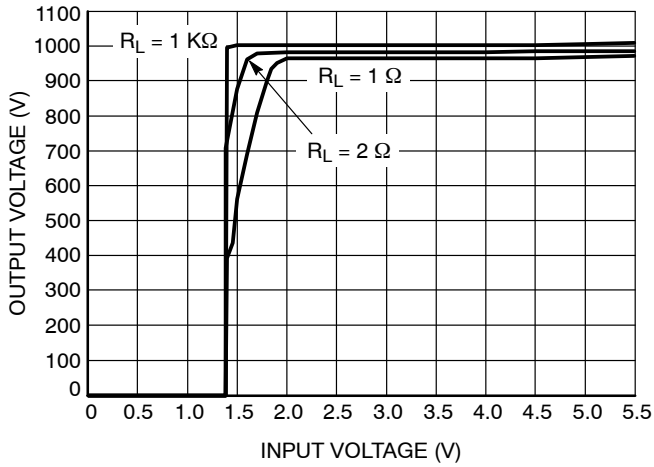

Figure 24. Dropout Characteristics

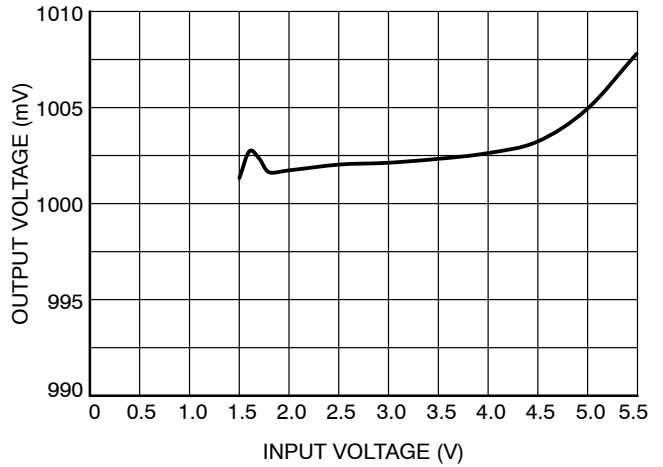

Figure 25. Line Regulation

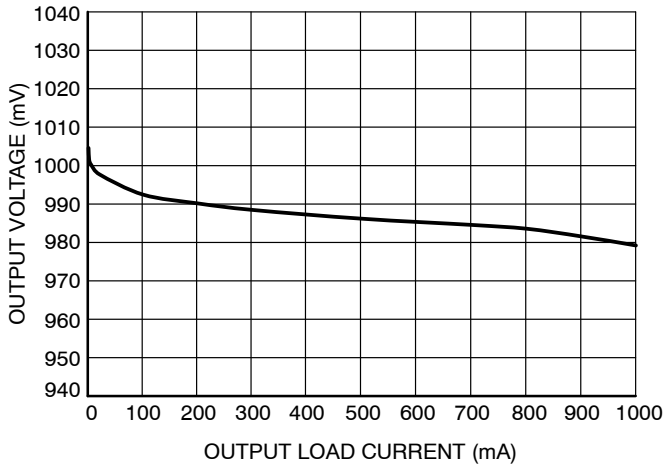

Figure 26. Load Regulation

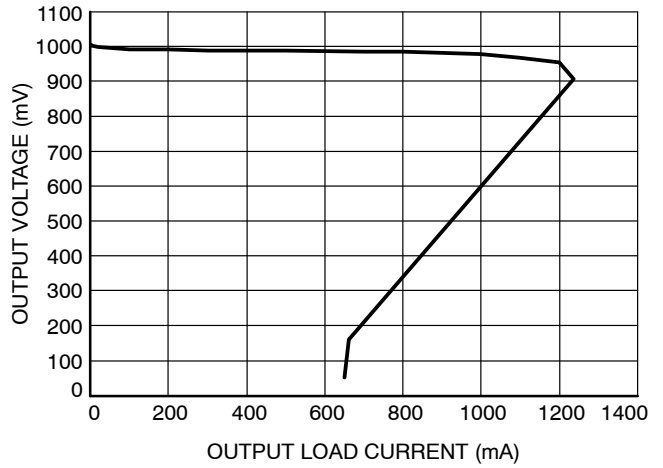

Figure 27. Output Current Capability

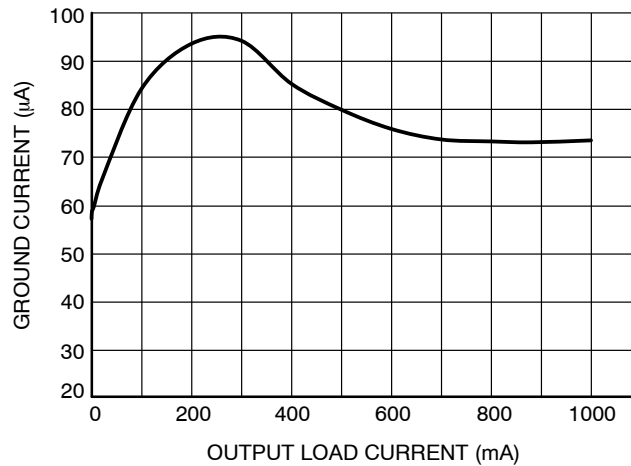

Figure 28. Ground Current vs. Load Current

TRANSIENT CHARACTERISTICS

(shown for  $V_{OUT} = 1.0\text{ V}$ ,  $V_{IN} = 2.0\text{ V}$ ,  $I_{OUT} = 1\text{ mA}$ ,  $C_{IN} = 1\text{ }\mu\text{F}$ ,  $C_{OUT} = 4.7\text{ }\mu\text{F}$ ,  $C_{BYP} = 0$ , and  $T_A = 25^\circ\text{C}$  unless otherwise specified.)

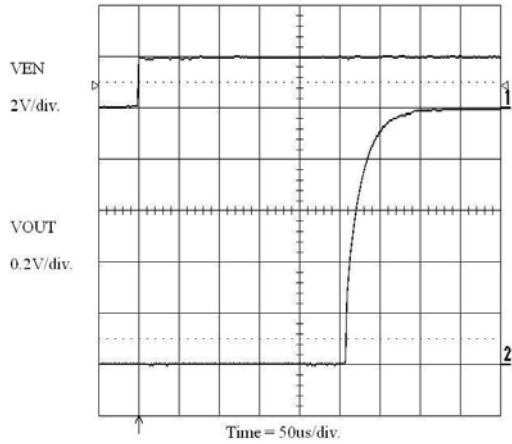

Figure 29. Enable Turn-on (1 mA Load)

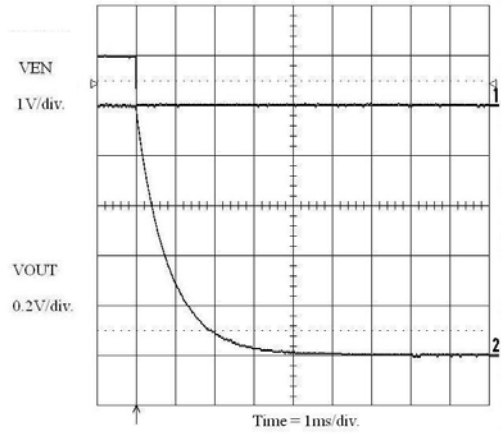

Figure 30. Enable Turn-off (1 mA Load)

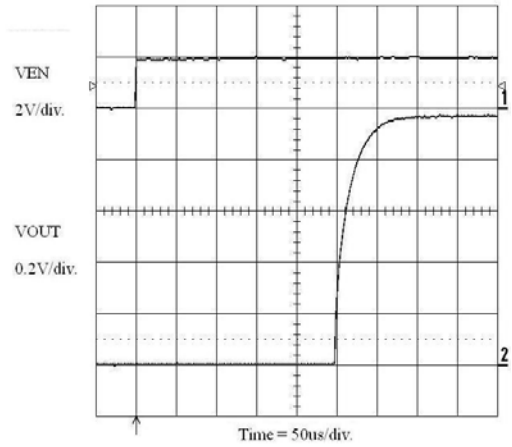

Figure 31. Enable Turn-on (1 A Load)

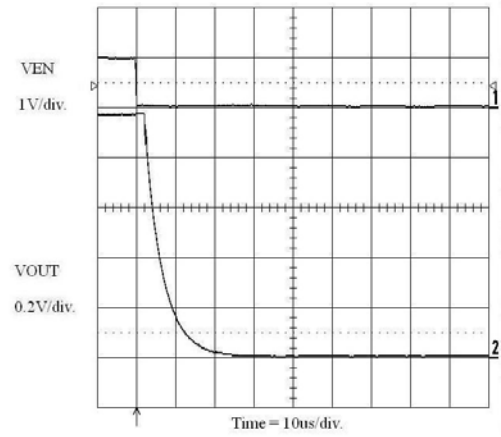

Figure 32. Enable Turn-off (1 A Load)

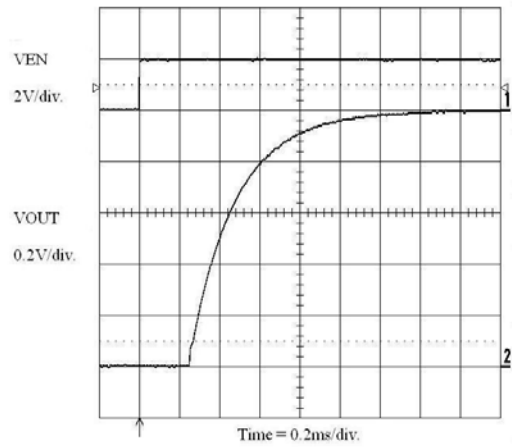

Figure 33. Enable Turn-on (1 mA Load)  
 $C_{BYP} = 470\text{ pF}$

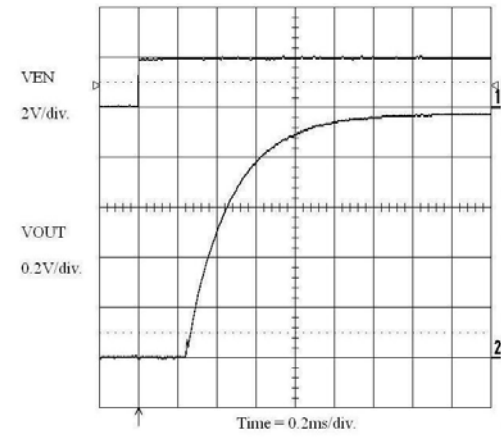
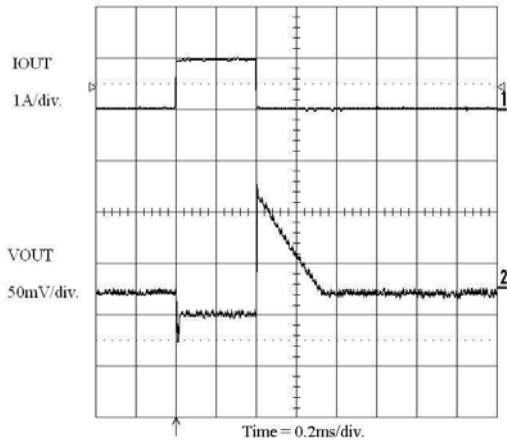

Figure 34. Enable Turn-on (1 A Load)  
 $C_{BYP} = 470\text{ pF}$

# CAT6241

## TRANSIENT CHARACTERISTICS

(shown for  $V_{OUT} = 1.0\text{ V}$ ,  $V_{IN} = 2.0\text{ V}$ ,  $I_{OUT} = 1\text{ mA}$ ,  $C_{IN} = 1\text{ }\mu\text{F}$ ,  $C_{OUT} = 4.7\text{ }\mu\text{F}$ ,  $C_{BYP} = 0$ , and  $T_A = 25^\circ\text{C}$  unless otherwise specified.)



**Figure 35. Load Transient Response  
(1 mA to 1 A)**

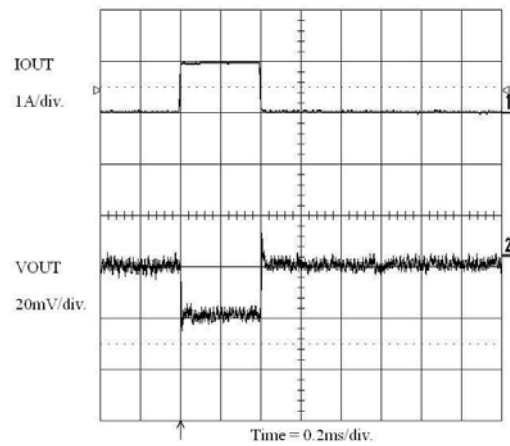

**Figure 36. Load Transient Response  
(1 mA to 1 A)  $V_{IN} = 2.2\text{ V}$**

# CAT6241

## PIN FUNCTIONS

### **V<sub>IN</sub>**

Positive Power Input. Power is supplied to the device through the V<sub>IN</sub> pin. A bypass capacitor is required on this pin if the device is more than six inches away from the main input filter capacitor. In general it is advisable to include a small bypass capacitor adjacent to the regulator. In battery-powered circuits this is particularly important because the output impedance of a battery rises with frequency, so a bypass capacitor in the range of 1  $\mu$ F to 10  $\mu$ F is recommended.

### **GND**

Ground. The negative voltage of the input power source. The center pad on the back of the package is also electrically ground. This pad is used for cooling the device by making connection to the buried ground plane through solder filled vias or by contact with a topside copper surface exposed to free flowing air.

### **ENABLE**

ENABLE is an active high logic input which controls the regulator's the output state. If ENABLE < 0.4 V the regulator is shutdown and V<sub>OUT</sub> = 0 V. If ENABLE > 1.6 V the regulator is active and supplying power to the load.

If the regulator is intended to operate continuously and won't be shut down from time to time ENABLE should be tied to V<sub>IN</sub>.

### **BYP**

The Bypass Capacitor input is used to decrease output voltage noise by placing a capacitor between BYP and ground. The recommended range of capacitance is from

100 pF to 470 pF. Values larger than this will provide no additional improvement and will further extend CAT6241's startup time.

A bypass capacitor is not required for operation and BYP may be left open or floating if no capacitor is used but DO NOT ground BYP as this will interfere with the error amplifier's functioning.

### **ADJ**

ADJ = Adjust and is the voltage control input. ADJ connects to the center point of a resistor divider which determines the CAT6241's output voltage. See Applications Section for resistor selection guidelines.

### **V<sub>OUT</sub>**

V<sub>OUT</sub> is the regulator's output and supplies power to the load. V<sub>OUT</sub> can be shut off via the ENABLE input. All CAT6241 members are designed to block reverse current, meaning anytime V<sub>OUT</sub> becomes greater than V<sub>IN</sub> the pass FET will be shut off so there is no reverse current flow from output to input. CAT6241 is also equipped with an output discharge transistor that is turned ON anytime ENABLE is at a logic Low. This transistor ensures V<sub>OUT</sub> discharges to 0 V when the regulator is shutdown. This is especially important when powering digital circuitry because if V<sub>OUT</sub> fails to reach 0 V their POR (power-ON reset) circuitry may not trigger and scrambled data or unpredictable operations may result.

A minimum output capacitor of 2.2  $\mu$ F should be placed between V<sub>OUT</sub> and GND to insure stable operation. Increasing the size of C<sub>OUT</sub>, up to 22  $\mu$ F, will improve transient response to large changes in load current.

APPLICATIONS INFORMATION

**Input Decoupling (C<sub>IN</sub>)**

A ceramic or tantalum 1 μF capacitor is recommended and should be connected close to the CAT6241's package. Higher capacitance and lower ESR will improve the overall line and load transient response.

**Output Decoupling (C<sub>OUT</sub>)**

The minimum output decoupling value is 2.2 μF and can be augmented to fulfill stringent load transient requirements. Larger values, up to 22 μF, improve noise rejection and load regulation transient response. The CAT6241 is a highly stable regulator and performs well over a wide range of Equivalent Series Resistances (ESR) with ceramic chip capacitors.

**No-Load Regulation Considerations**

The CAT6241 adjustable regulator will operate properly under conditions where the only load current is through the resistor divider that sets the output voltage. However, in the case where the CAT6241 is configured to provide a 0.5 V output, there is no resistor divider and the ADJ pin is connected to V<sub>OUT</sub>. If the part is enabled under no-load conditions, leakage current through the pass transistor at junction temperatures above 85°C can approach several microamperes, especially as junction temperature approaches 150°C. If this leakage current is not directed into a load, the output voltage will rise above nominal until a load is applied. For this reason it is recommended that a minimum load of 100 μA be present at all times. Normally the voltage setting resistor divider will serve this function but if no divider is used (V<sub>OUT</sub> = 0.5 V) then an external load of 5 KΩ should be provided.

**Output Voltage Adjust**

The output voltage can be adjusted from 0.5 V to 5.0 V using resistors between the output and the ADJ input. The output voltage and resistors are chosen using Equation 1 and Equation 2.

$$V_{OUT} = 0.5 \left( 1 + \frac{R_1}{R_2} \right) + (I_{ADJ} \times R_1) \quad (\text{eq. 1})$$

$$R_2 \cong \frac{0.5 \text{ V}}{I_{DIV}} \quad (\text{eq. 2})$$

$$R_1 \cong R_2 \left( \frac{V_{OUT}}{0.5 \text{ V}} - 1 \right) \quad (\text{eq. 3})$$

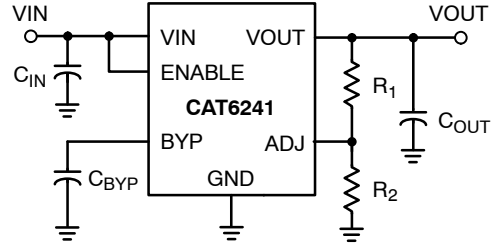

**Figure 37. Adjustable Output Resistor Divider**

Input bias current, I<sub>ADJ</sub>, for all practical designs can be ignored (I<sub>ADJ</sub> = 0). Considering that the lowest recommended I<sub>OUT</sub> value is 100 μA, then, when there is no load on V<sub>OUT</sub>, I<sub>divider</sub> must be 100 μA to keep CAT6241 in regulation. This then sets R2's value using Equation 2 to 5 KΩ, which minimizes output noise. Use Equation 3 to find the required value for R1. If needed, lower values for I<sub>DIV</sub> can be considered, but not lower than 10 μA. The trade-off will be worse values for both load regulation and TC<sub>OUT</sub>.

**Thermal Considerations**

As power in the CAT6241 increases, it may become necessary to provide thermal relief. The maximum power dissipation supported by this device is dependent upon board design and layout. Mounting pad configuration on the PCB, the board material, and the ambient temperature affect the rate of junction temperature rise for the part. When the CAT6241 has good thermal conductivity through the PCB, the junction temperature will be relatively low even with high power applications. The maximum dissipation the CAT6241 can handle is given by:

$$P_{D(MAX)} = \frac{[T_{J(MAX)} - T_A]}{R_{\theta JA}} \quad (\text{eq. 4})$$

Since T<sub>J</sub> is not recommended to exceed 125°C, then with CAT6241 soldered to 645 mm<sup>2</sup> (1 sq inch), 1 oz copper area, FR4 PCB material can dissipate in excess of 1 W when the ambient temperature (T<sub>A</sub>) is 25°C. Note that this assumes the pad in the center of the package is soldered to the dissipating copper foil. See Figure below for R<sub>θJA</sub> versus PCB area for heat dissipating areas smaller than 645 mm<sup>2</sup>. Power dissipation can be calculated from the following equations:

$$P_D \approx V_{IN}(I_{GND} + I_{OUT}) + I_{OUT}(V_{IN} - V_{OUT}) \quad (\text{eq. 5})$$

or

$$V_{IN(MAX)} \approx \frac{P_{D(MAX)} + (V_{OUT} \times I_{OUT})}{I_{OUT} + I_{GND}} \quad (\text{eq. 6})$$

# CAT6241

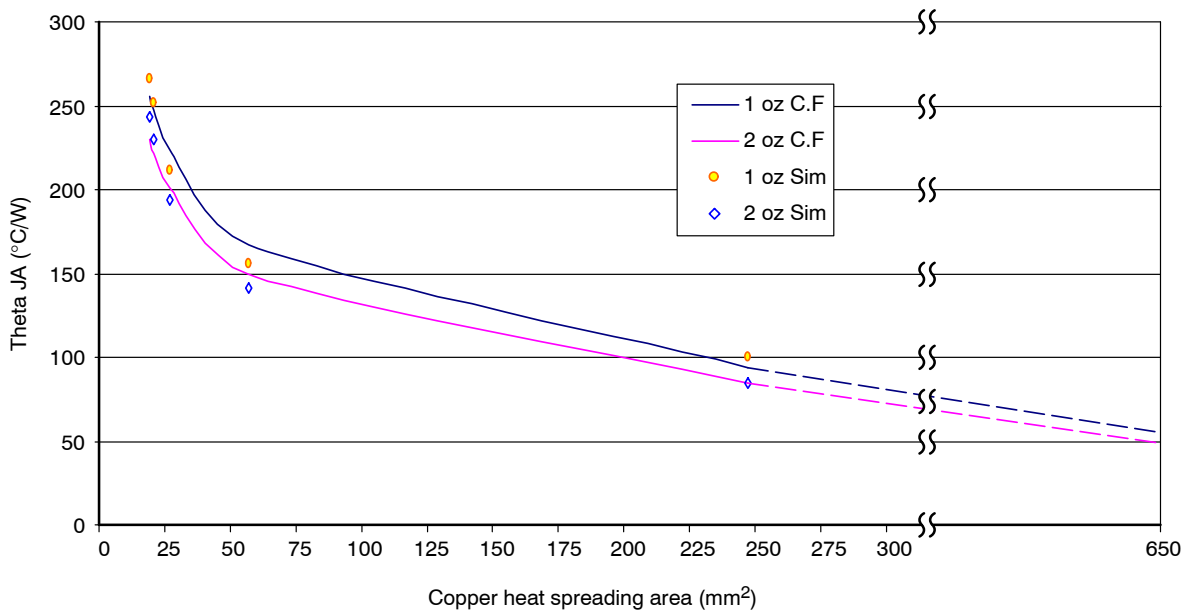

**Figure 38. Thermal Resistance vs. PCB Copper Area for 3 mm x 3 mm WDFN Package**

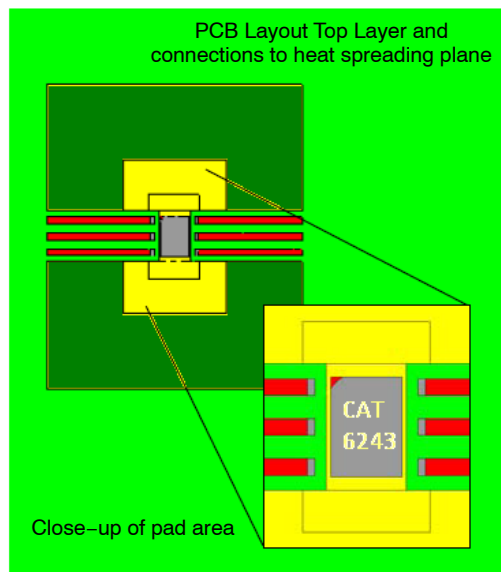

**Figure 39. Topside Copper Foil Pattern for Heat Dissipation**

## Design Hints

$V_{IN}$  and GND printed circuit board traces should be as wide as possible. When the impedance of these traces is high due to narrow trace width or long length, there is a chance to pick up noise or cause the regulator to malfunction. Place

external components, especially the input and output capacitors, as close as possible to the CAT6241, and keep traces between power source and load as short as possible.

# CAT6241

## PACKAGE DIMENSIONS

WDFN6 3x3, 0.95P  
CASE 511AP-01  
ISSUE O

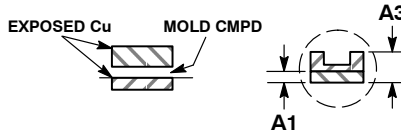
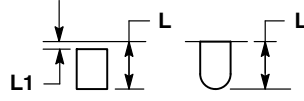
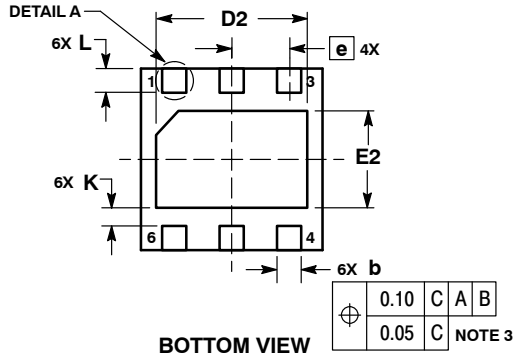
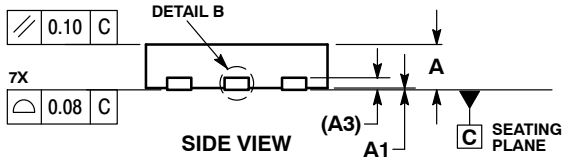
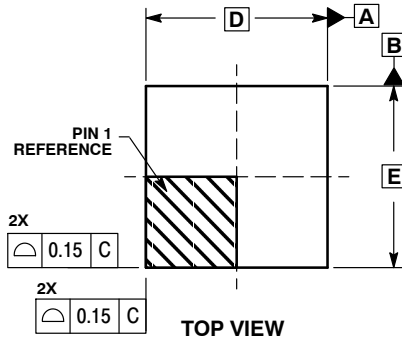

- NOTES:
1. DIMENSIONS AND TOLERANCING PER ASME Y14.5M, 1994.
  2. CONTROLLING DIMENSION: MILLIMETERS.
  3. DIMENSION b APPLIES TO PLATED TERMINAL AND IS MEASURED BETWEEN 0.15 AND 0.30 MM FROM TERMINAL.
  4. COPLANARITY APPLIES TO THE EXPOSED PAD AS WELL AS THE TERMINALS.

MILLIMETERS		
DIM	MIN	MAX
A	0.70	0.80
A1	0.00	0.05
A3	0.20	REF
b	0.35	0.45
D	3.00	BSC
D2	2.40	2.60
E	3.00	BSC
E2	1.50	1.70
e	0.95	BSC
K	0.20	---
L	0.30	0.50
L1	---	0.15

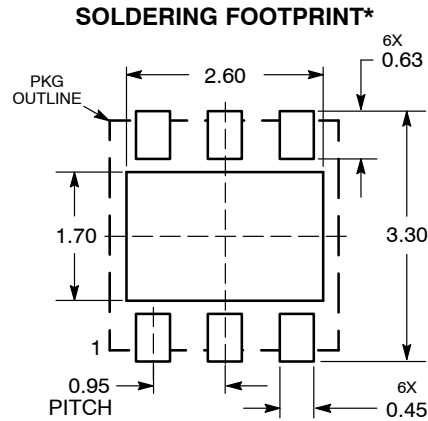

DIMENSIONS: MILLIMETERS

\*For additional information on our Pb-Free strategy and soldering details, please download the ON Semiconductor Soldering and Mounting Techniques Reference Manual, SOLDERRM/D.

# CAT6241

## PACKAGE DIMENSIONS

UDFN8, 2x2  
CASE 517AW-01  
ISSUE O

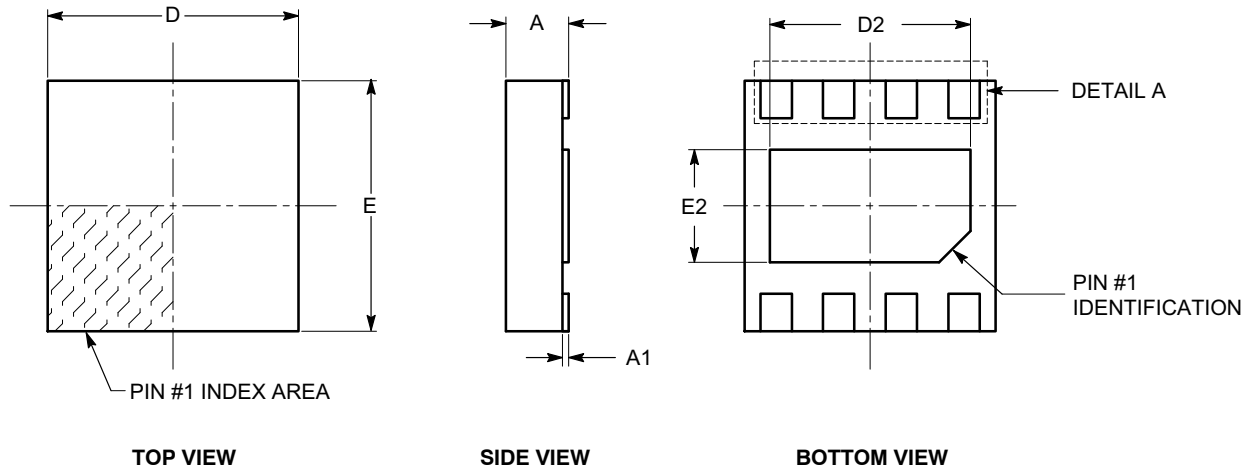

SYMBOL	MIN	NOM	MAX
A	0.45	0.50	0.55
A1	0.00	0.02	0.05
b	0.18	0.25	0.30
D	1.90	2.00	2.10
D2	1.50	1.60	1.70
E	1.90	2.00	2.10
E2	0.80	0.90	1.00
e	0.50 BSC		
L	0.20	0.30	0.45

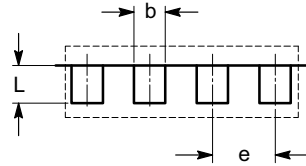

DETAIL A

**Notes:**

- (1) All dimensions are in millimeters.
- (2) Complies with JEDEC MO-229.



# CAT6241

**Table 6. ORDERING INFORMATION** (Notes 9 – 12)

Device	Output Voltage	Package	Shipping
CAT6241-ADJMT5T3	Adjustable	WDFN-6, 3 mm x 3 mm (Pb-Free)	3,000 / Tape & Reel
CAT6241-ADJHU2MUTAG	Adjustable	UDFN-8, 2 mm x 2 mm (Pb-Free)	3,000 / Tape & Reel

9. The standard lead finish is Matte-Tin.
10. For additional package and temperature options, contact your nearest ON Semiconductor Sales office.
11. For information on tape and reel specifications, including part orientation and tape sizes, please refer to our Tape and Reel Packaging Specifications Brochure, BRD8011/D.
12. For detailed information and a breakdown of device nomenclature and numbering systems, please see the ON Semiconductor Device Nomenclature document, TND310/D, available at [www.onsemi.com](http://www.onsemi.com)

ON Semiconductor and  are registered trademarks of Semiconductor Components Industries, LLC (SCILLC). SCILLC owns the rights to a number of patents, trademarks, copyrights, trade secrets, and other intellectual property. A listing of SCILLC's product/patent coverage may be accessed at [www.onsemi.com/site/pdf/Patent-Marking.pdf](http://www.onsemi.com/site/pdf/Patent-Marking.pdf). SCILLC reserves the right to make changes without further notice to any products herein. SCILLC makes no warranty, representation or guarantee regarding the suitability of its products for any particular purpose, nor does SCILLC assume any liability arising out of the application or use of any product or circuit, and specifically disclaims any and all liability, including without limitation special, consequential or incidental damages. "Typical" parameters which may be provided in SCILLC data sheets and/or specifications can and do vary in different applications and actual performance may vary over time. All operating parameters, including "Typicals" must be validated for each customer application by customer's technical experts. SCILLC does not convey any license under its patent rights nor the rights of others. SCILLC products are not designed, intended, or authorized for use as components in systems intended for surgical implant into the body, or other applications intended to support or sustain life, or for any other application in which the failure of the SCILLC product could create a situation where personal injury or death may occur. Should Buyer purchase or use SCILLC products for any such unintended or unauthorized application, Buyer shall indemnify and hold SCILLC and its officers, employees, subsidiaries, affiliates, and distributors harmless against all claims, costs, damages, and expenses, and reasonable attorney fees arising out of, directly or indirectly, any claim of personal injury or death associated with such unintended or unauthorized use, even if such claim alleges that SCILLC was negligent regarding the design or manufacture of the part. SCILLC is an Equal Opportunity/Affirmative Action Employer. This literature is subject to all applicable copyright laws and is not for resale in any manner.

## PUBLICATION ORDERING INFORMATION

### LITERATURE FULFILLMENT:

Literature Distribution Center for ON Semiconductor  
P.O. Box 5163, Denver, Colorado 80217 USA  
**Phone:** 303-675-2175 or 800-344-3860 Toll Free USA/Canada  
**Fax:** 303-675-2176 or 800-344-3867 Toll Free USA/Canada  
**Email:** [orderlit@onsemi.com](mailto:orderlit@onsemi.com)

**N. American Technical Support:** 800-282-9855 Toll Free  
USA/Canada  
**Europe, Middle East and Africa Technical Support:**  
Phone: 421 33 790 2910  
**Japan Customer Focus Center**  
Phone: 81-3-5817-1050

**ON Semiconductor Website:** [www.onsemi.com](http://www.onsemi.com)

**Order Literature:** <http://www.onsemi.com/orderlit>

For additional information, please contact your local Sales Representative

## X-ON Electronics

Largest Supplier of Electrical and Electronic Components

*Click to view similar products for [LDO Voltage Regulators](#) category:*

*Click to view products by [ON Semiconductor](#) manufacturer:*

Other Similar products are found below :

[M38D29FFHP#U1](#) [702103A](#) [717726C](#) [742457H](#) [MP20051DN-LF-Z](#) [R5F111PGGFB#30](#) [AP7363-SP-13](#) [NCP103AMX285TCG](#)  
[NCV8664CST33T3G](#) [NCV8752AMX28TCG](#) [L9454](#) [AP7362-HA-7](#) [LX13043CLD](#) [TCR3DF185,LM\(CT](#) [TCR3DF24,LM\(CT](#)  
[TCR3DF285,LM\(CT](#) [TCR3DF31,LM\(CT](#) [TCR3DF45,LM\(CT](#) [TLF4949EJ](#) [L9708](#) [L970813TR](#) [030014BB](#) [059985X](#) [EAN61387601](#)  
[EAN61573601](#) [NCP121AMX173TCG](#) [NCP4687DH15T1G](#) [NCV8703MX30TCG](#) [701326R](#) [702087BB](#) [755078E](#) [TCR2EN28,LF\(S](#)  
[LM1117DT-1.8/NO](#) [LT1086CM#TRPBF](#) [AZ1085S2-1.5TRE1](#) [TLE4279GXUMA2](#) [MAX15101EWL+T](#) [NCV8170AXV250T2G](#)  
[SCD337BTG](#) [TCR3DF27,LM\(CT](#) [TCR3DF19,LM\(CT](#) [TCR3DF125,LM\(CT](#) [TCR2EN18,LF\(S](#) [MAX15103EWL+T](#) [TS2937CZ-5.0 C0](#)  
[MAX8878EUK30-T](#) [MAX663CPA](#) [NCV4269CPD50R2G](#) [NCV8716MT30TBG](#) [AZ1117IH-1.2TRG1](#)