

## RR Series — General Purpose Power Relays

## Key features of the RR series include:

- High reliability and long service life
- Available in octal (8- and 11-pin) or square (11-blade) base
- Options include check button for test operation, indicator light, and side flange (contact IDEC for diodes)
- DIN rail, surface and panel type sockets available for a wide range of mounting applications



UL Recognized  
File No. E66043



CSA Certified  
File No. LR35144



File No. B020813332452\*  
\* Pin Style Only  
(does not apply to blade style)



\* Pin Style Only

|   |   |
|---|---|
| <b>Contact Material</b>                                   | Silver  |
| <b>Contact Resistance</b>                                 | 30mΩ maximum (initial value)  |
| <b>Minimum Applicable Load</b>                            | 24V DC/10mA, 5V DC/20mA (reference value)   |
| <b>Operating Time</b>                                     | 25ms maximum  |
| <b>Release Time</b>                                       | 25ms maximum  |
| <b>Maximum Continuous Applied Voltage (AC/DC) at 20°C</b> | 110% of the rated voltage   |
| <b>Minimum Operating Voltage (AC/DC) at 20°C</b>          | 80% of the rated voltage  |
| <b>Drop-Out Voltage (AC) at 20°C</b>                      | 30% of the rated voltage  |
| <b>Drop-Out Voltage (DC) at 20°C</b>                      | 15% of the rated voltage  |
| <b>Power Consumption</b>                                  | AC: approximately 3VA (50Hz), 2.5VA (60Hz)<br>DC: approximately 1.5W  |
| <b>Insulation Resistance</b>                              | 100MΩ minimum (measured with 500V DC megger)  |
| <b>Dielectric Strength</b>                                | <b>Pin</b> (RR2P, RR3PA)<br>Between live and dead parts:<br>1,500V AC, 1 minute<br>Between contact circuit and operating coil:<br>1,500V AC, 1 minute<br>Between contact circuits: 1,500V AC,<br>1 minute (1,000V AC between NO-NC contacts)<br><b>Blade</b> (RR1BA, RR2BA, RR3B)<br>Between live and dead parts:<br>2,000V AC, 1 minute<br>Between contact circuit and operating coil:<br>2,000V AC, 1 minute<br>Between contact circuits:<br>2,000V AC, 1 minute<br>Between contacts of same polarity:<br>1,000V AC, 1 minute |
| <b>Frequency Response</b>                                 | 1,800 operations/hour   |
| <b>Temperature Rise</b>                                   | Coil: 85°C maximum<br>Contact: 65°C maximum   |
| <b>Vibration Resistance</b>                               | 0 to 6G (55Hz maximum)  |
| <b>Shock Resistance</b>                                   | 100N (approximately 10G)  |
| <b>Life Expectancy</b>                                    | Electrical: over 500,000 operations (120V, 50/60Hz, 10A)<br>Mechanical: over 10,000,000 operations  |
| <b>Operating Temperature</b>                              | -30 to +70°C  |
| <b>Weight</b>   | RR2P: 90g, RR3PA: 96g (approximately)<br>RR1BA/RR2BA/RR3B: 82g (approximately)  |

## Ordering Information

Order standard voltages for fastest delivery. Allow extra delivery time for non-standard voltages.

**Basic Part No.**

**RR3PA-U**

**Coil Voltage:**

**AC120V**

## Part Numbers

### Part Numbers: RR Series with Options

| Termination      | Contact Configuration | Basic Part No. | Indicator Light | Check Button | Light and Check Button | Side Flange |
|------------------|-----------------------|----------------|-----------------|--------------|------------------------|-------------|
| P, PA<br>(pin)   | DPDT                  | RR2P-U         | RR2P-UL         | RR2P-UC      | RR2P-ULC               | —           |
|                  | 3PDT                  | RR3PA-U        | RR3PA-UL        | RR3PA-UC     | RR3PA-ULC              | —           |
| B, BA<br>(blade) | SPDT                  | RR1BA-U        | RR1BA-UL        | RR1BA-UC     | RR1BA-ULC              | RR1BA-US    |
|                  | DPDT                  | RR2BA-U        | RR2BA-UL        | RR2BA-UC     | RR2BA-ULC              | RR2BA-US    |
|                  | 3PDT                  | RR3B-U         | RR3B-UL         | RR3B-UC      | RR3B-ULC               | RR3B-US     |



1. RR1BA, RR2BA, and RR3PA are U.S. standard terminal arrangements.
2. For diode option on DC coils please consult factory.

## Ratings

### Coil Ratings

| Rated Voltage | Rated Current ±15% at 20°C |        | Coil Resistance ±10% at 20°C | Inrush Current | Inductance |               |       |
|---------------|----------------------------|--------|------------------------------|----------------|------------|---------------|-------|
|               | 60Hz                       | 50Hz   |                              |                | Energizing | De-Energizing |       |
| AC            | 6V                         | 420mA  | 490mA                        | 4.9Ω           | 720mA      | 0.04H         | 0.02H |
|               | 12V                        | 210mA  | 245mA                        | 18Ω            | 365mA      | 0.15H         | 0.08H |
|               | 24V                        | 105mA  | 121mA                        | 79Ω            | 182mA      | 0.57H         | 0.32H |
|               | 120V                       | 20.5mA | 24mA                         | 2100Ω          | 35mA       | 15H           | 8.2H  |
|               | 240V                       | 10.5mA | 12.1mA                       | 8330Ω          | 18mA       | 57H           | 32H   |
| DC            | 6V                         | 240mA  |                              | 25Ω            | N/A        |               |       |
|               | 12V                        | 120mA  |                              | 100Ω           |            |               |       |
|               | 24V                        | 60mA   |                              | 400Ω           |            |               |       |
|               | 48V                        | 30mA   |                              | 1600Ω          |            |               |       |
|               | 110V                       | 13mA   |                              | 8460Ω          |            |               |       |

### Contact Ratings

| Voltage | Resistive |     |     | Inductive |      |      | Motor Load |
|---------|-----------|-----|-----|-----------|------|------|------------|
|         | Nominal   | UL  | CSA | Nominal   | UL   | CSA  | UL         |
| 30V DC  | 10A       | 10A | 10A | 7.5A      | 7A   | 7.5A | —          |
| 110V DC | 0.5A      | —   | —   | 0.3A      | —    | 0.5A | —          |
| 120V AC | 10A       | 10A | 10A | 7.5A      | 7.5A | 7.5A | 1/4 hp     |
| 240V AC | 7.5A      | 10A | 10A | 5A        | 7A   | 7A   | 1/3 hp     |



Inductive load:  
 $\cos \phi = 0.3, L/R = 7ms.$

## Applicable Sockets

### Part Numbers: Sockets

| Relays                 | Standard DIN Rail Mount | Finger-Safe DIN Rail Mount | Panel Mount | Springs & Clips (optional) |                                    |
|------------------------|-------------------------|----------------------------|-------------|----------------------------|------------------------------------|
|                        |                         |                            |             | Part Numbers               | Use With Socket                    |
| RR2P                   | SR2P-05<br>SR2P-06      | SR2P-05C                   | SR2P-51     | SR2B-02F1                  | SR2P-05, -05C, -06                 |
|                        |                         |                            |             | SR3P-01F1                  | SR2P-51, SR3P-51                   |
| RR3PA                  | SR3P-05<br>SR3P-06      | SR3P-05C                   | SR3P-51     | SR3B-02F1                  | SR3P-05, -05C, -06<br>SR3B-05, -51 |
|                        |                         |                            |             | SR3P-01F1                  | SR3P-51                            |
| RR1BA<br>RR2BA<br>RR3B | SR3B-05                 | —                          | SR3B-51     | SR3B-02F1                  | SR3B-05<br>SR3B-51                 |



See Section F for details on sockets. All DIN rail mount sockets listed can be mounted using DIN rail BNDN1000.

Internal Circuits

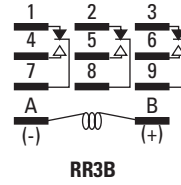
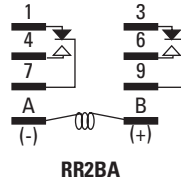
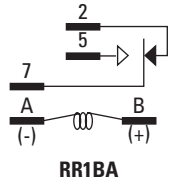
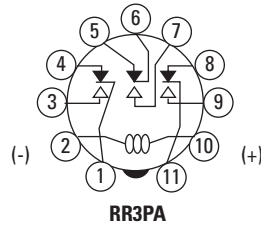
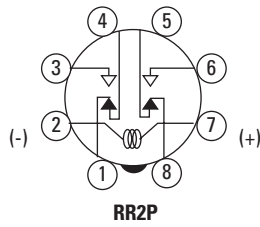
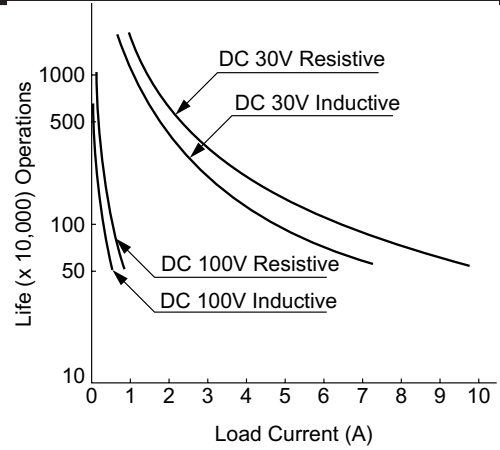
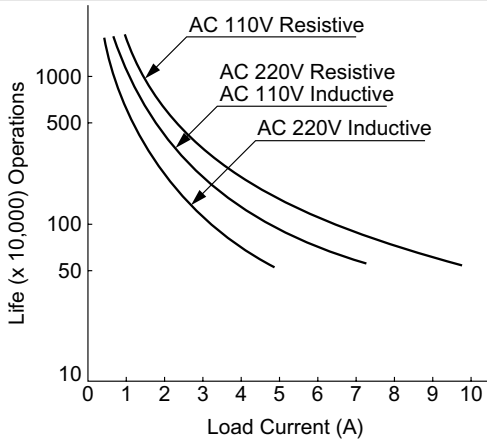
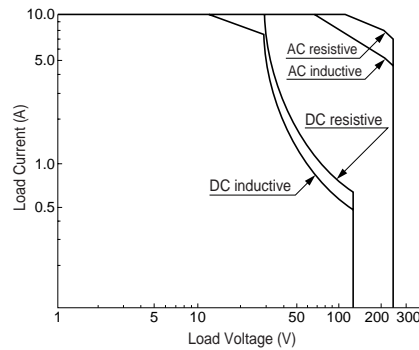

Image as viewed from bottom of relay. Refer to socket for exact wiring layout (Section F).

Electrical Life Curves



Maximum Switching Capacity



## Dimensions

### 8-Pin RR2P

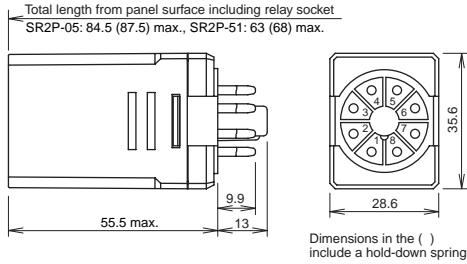

### 11-Pin RR3PA

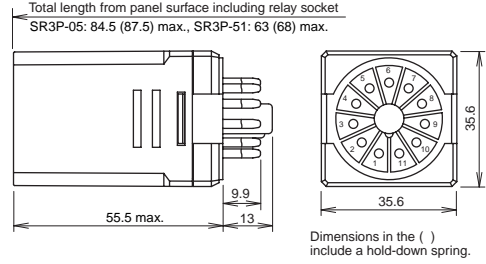

### Blade RR1BA, RR2BA, RR3B

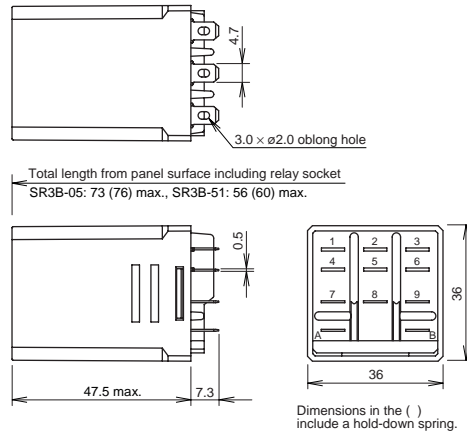

### Side Flange RR1BA-US, RR2BA-US, RR3B-US

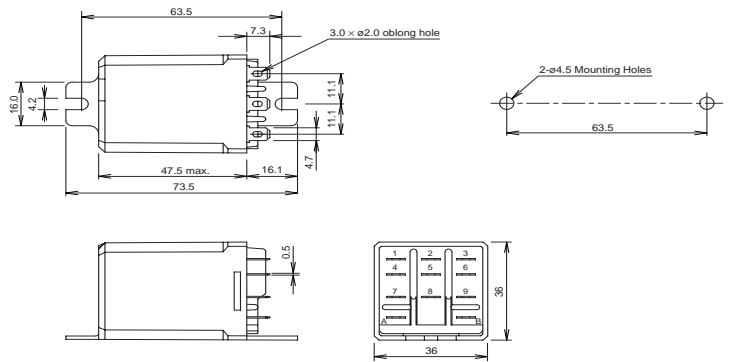

**Note:** Dimensions in [ ] include hold-down spring.

All dimensions in mm.

## X-ON Electronics

Largest Supplier of Electrical and Electronic Components

*Click to view similar products for [General Purpose Relays](#) category:*

*Click to view products by [Idec](#) manufacturer:*

Other Similar products are found below :

[APF30318](#) [JVN1AF-4.5V-F](#) [PCN-105D3MHZ](#) [5JO-10000S-SIL](#) [5JO-1000CD-SIL](#) [5JO-400CD-SIL](#) [LY2S-AC220/240](#) [LYQ20DC12](#)  
[6031007G](#) [6131406HQ](#) [6-1393099-3](#) [6-1393099-8](#) [6-1393122-4](#) [6-1393123-2](#) [6-1393767-1](#) [6-1393843-7](#) [6-1415012-1](#) [6-1419102-2](#) [6-](#)  
[1423698-4](#) [6-1608051-6](#) [6-1608067-0](#) [6-1616170-6](#) [6-1616248-2](#) [6-1616282-3](#) [6-1616348-2](#) [6-1616350-1](#) [6-1616350-8](#) [6-1616358-7](#) [6-](#)  
[1616359-9](#) [6-1616360-9](#) [6-1616931-6](#) [6-1617039-1](#) [6-1617052-1](#) [6-1617090-2](#) [6-1617090-5](#) [6-1617347-5](#) [6-1617353-3](#) [6-1617801-8](#) [6-](#)  
[1617802-2](#) [6-1618107-9](#) [6-1618248-4](#) [M83536/1-027M](#) [CX-4014](#) [MAHC-5494](#) [MAVCD-5419-6](#) [703XCX-120A](#) [7-1393100-5](#) [7-1393111-7](#)  
[7-1393144-5](#) [7-1393767-8](#)