

# Kingbright

## Optoelectronic Components

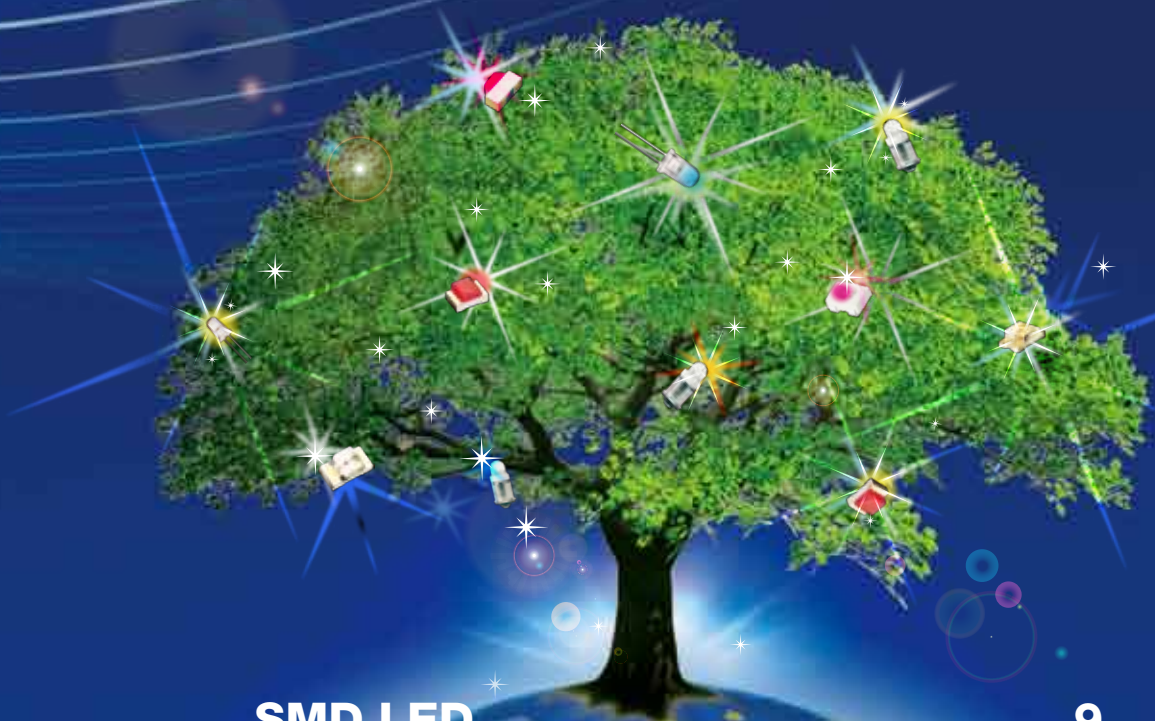



### **SMD LED**

**9**

Top-Emitting PLCC SMD LED	9
Top-Emitting Chip SMD LED	10
Right Angle SMD LED	16
Multi-Color SMD LED	19
Subminiature SMD LED	23
Reverse Mount SMD LED	25
SOT-23 SMD LED	25
Ambient Light Sensor	26
Color Sensor	26

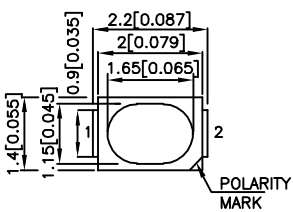
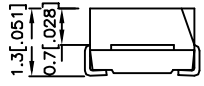
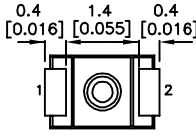

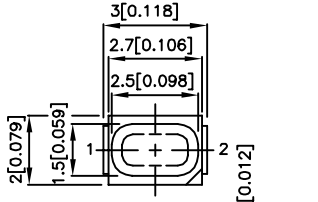
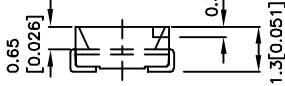
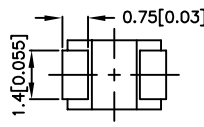
TOP-EMITTING PLCC SMD LED

PART NUMBER	MATERIAL	λD (nm)	LENS TYPE	Iv (mcd) @20mA		VIEWING ANGLE 2θ1/2	DIMENSION
				MIN.	TYP.		
KA-2214SURSK	AlGaInP	630	water clear	180	400	120°	2.2mm x 1.4mm  KA-2214    Units : mm(inch) Tolerance : ±0.2(0.008)
KA-2214SESK	AlGaInP	601	water clear	280	450	120°	
KA-2214MGS	AlGaInP	570	water clear	50	150	120°	
KA-2214CGSK	AlGaInP	570	water clear	50	100	120°	
KA-2214ZGS	InGaIn	525	water clear	280	550	120°	
KA-2214QBS-G	InGaIn	465	water clear	110	300	120°	
KA-3021SURCKT	AlGaInP	630	water clear	70	200	125°	3.0mm x 2.0mm (1208)  KA-3021    Units : mm(inch) Tolerance : ±0.25(0.01)
KA-3021SECKT	AlGaInP	601	water clear	180	400	125°	
KA-3021SYCKT	AlGaInP	590	water clear	110	200	125°	
KA-3021MGCT	AlGaInP	570	water clear	50	100	125°	
KA-3021CGCKT	AlGaInP	570	water clear	50	85	125°	
KA-3021ZGCT	InGaIn	525	water clear	380	500	125°	
KA-3021ZGCT-E	InGaIn	525	water clear	900	1500	125°	
KA-3021ZGCT-G	InGaIn	525	water clear	1200	1600	125°	
KA-3021QBCT-D	InGaIn	470	water clear	50	150	125°	
KA-3021QBCT-F	InGaIn	465	water clear	110	250	125°	
KA-3021QBCT-G	InGaIn	465	water clear	180	350	125°	
KA-3022ECT-4.5SF	GaAsP/GaP	625	water clear	7	30	90°	
KA-3022SRCT-4.5SF	GaAlAs	640	water clear	36	150	90°	
KA-3022YCT-4.5SF	GaAsP/GaP	588	water clear	4	15	90°	
KA-3022SGCT-4.5SF	GaP	568	water clear	7	20	90°	
KA-3022ZGCT-4.5SF	InGaIn	525	water clear	280	500	90°	
KA-3022ZGCT-E-4.5SF	InGaIn	525	water clear	380	800	90°	
KA-3022ZGCT-G-4.5SF	InGaIn	525	water clear	480	900	90°	
KA-3022QBCT-D-4.5SF	InGaIn	470	water clear	50	150	90°	
KA-3022QBCT-F-4.5SF	InGaIn	465	water clear	70	180	90°	
KA-3022QBCT-G-4.5SF	InGaIn	465	water clear	110	250	90°	

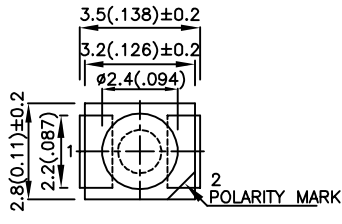
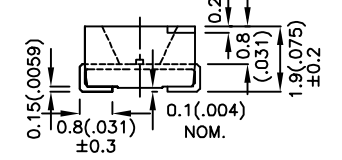
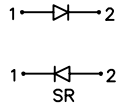
## TOP-EMITTING PLCC SMD LED

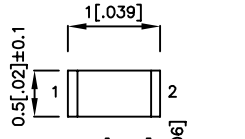
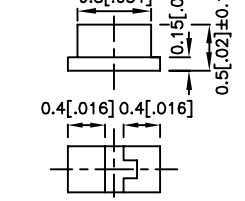
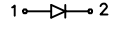

PART NUMBER	MATERIAL	$\lambda_D$ (nm)	LENS TYPE	Iv (mcd) @20mA		VIEWING ANGLE 2 $\theta$ 1/2	DIMENSION
				MIN.	TYP.		
KA-3528ECT	GaAsP/GaP	625	water clear	7	30	120°	3.5mm x 2.8mm  KA-3528   POLARITY MARK  SR Units : mm(inch) Tolerance : ±0.25(0.01)
KA-3528SRCT	GaAlAs	640	water clear	50	150	120°	
KA-3528SURCKT	AlGaInP	630	water clear	70	350	120°	
KA-3528SECKT	AlGaInP	601	water clear	110	400	120°	
KA-3528YCT	GaAsP/GaP	588	water clear	4	20	120°	
KA-3528SYCKT	AlGaInP	590	water clear	70	200	120°	
KA-3528SGCT	GaP	568	water clear	10	25	120°	
KA-3528MGCT	AlGaInP	570	water clear	50	150	120°	
KA-3528CGCKT	AlGaInP	570	water clear	36	100	120°	
KA-3528ZGCT	InGaN	525	water clear	380	600	120°	
KA-3528ZGCT-E	InGaN	525	water clear	480	900	120°	
KA-3528ZGCT-G	InGaN	525	water clear	650	1000	120°	
KA-3528QBCT-D	InGaN	470	water clear	50	150	120°	
KA-3528QBCT-F	InGaN	465	water clear	110	280	120°	
KA-3528QBCT-G	InGaN	465	water clear	180	370	120°	

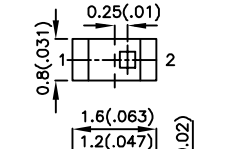
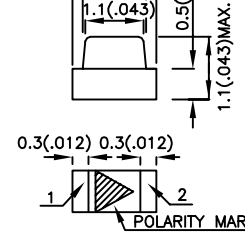
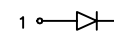
## TOP-EMITTING CHIP SMD LED

PART NUMBER	MATERIAL	$\lambda_D$ (nm)	LENS TYPE	Iv (mcd) @20mA		VIEWING ANGLE 2 $\theta$ 1/2	DIMENSION
				MIN.	TYP.		
KPHHS-1005SURCK	AlGaInP	630	water clear	70	220	120°	1.0mm x 0.5mm x 0.5mm (0402)  KPHHS-1005   POLARITY MARK  Units : mm(inch) Tolerance : ±0.1(0.004)
KPHHS-1005SECK	AlGaInP	601	water clear	70	240	120°	
KPHHS-1005SYCK	AlGaInP	590	water clear	50	150	120°	
KPHHS-1005CGCK	AlGaInP	570	water clear	10	50	120°	
KPHHS-1005ZGC-V	InGaN	525	water clear	110	300	120°	
KPHHS-1005QBC-D-V	InGaN	470	water clear	36	100	120°	
KP-1608SURCK	AlGaInP	630	water clear	70	220	120°	1.6mm x 0.8mm x 1.1mm (0603)  KP-1608   POLARITY MARK  Units : mm(inch) Tolerance : ±0.1(0.004)
KP-1608SECK	AlGaInP	601	water clear	70	240	120°	
KP-1608SYCK	AlGaInP	590	water clear	50	150	120°	
KP-1608MGC	AlGaInP	570	water clear	36	70	120°	
KP-1608CGCK	AlGaInP	570	water clear	10	50	120°	
KP-1608ZGC	InGaN	525	water clear	110	300	120°	
KP-1608ZGC-E	InGaN	525	water clear	280	650	120°	
KP-1608ZGC-G	InGaN	525	water clear	380	700	120°	
KP-1608QBC-D	InGaN	470	water clear	36	100	120°	
KP-1608QBC-F	InGaN	465	water clear	50	150	120°	
KP-1608QBC-G	InGaN	465	water clear	70	180	120°	

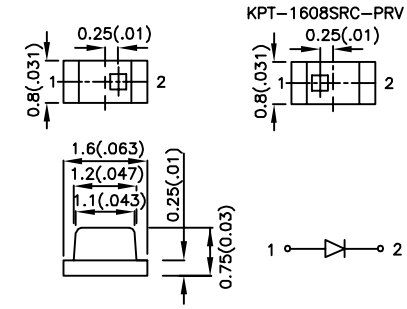
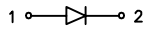
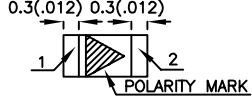

NOTE:  
1.KP series custom-made is available upon request.

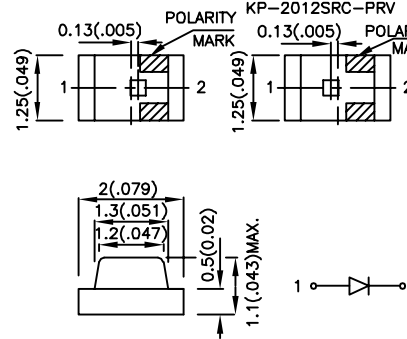
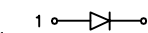
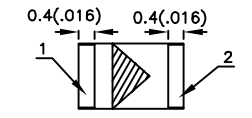
TOP-EMITTING CHIP SMD LED

PART NUMBER	MATERIAL	$\lambda_D$ (nm)	LENS TYPE	Iv (mcd) @20mA		VIEWING ANGLE 2 $\theta$ 1/2	DIMENSION
				MIN.	TYP.		
KPT-1608EC	GaAsP/GaP	625	water clear	4	15	120°	1.6mm x 0.8mm x 0.75mm (0603 Super Thin)  KPT-1608    Units : mm(inch) Tolerance : ±0.1(0.004)
KPT-1608SRC-PRV	GaAlAs	640	water clear	36	100	120°	
KPT-1608SURCK	AlGaInP	630	water clear	70	220	120°	
KPT-1608SECK	AlGaInP	601	water clear	70	240	120°	
KPT-1608YC	GaAsP/GaP	588	water clear	2.6	8	120°	
KPT-1608SYCK	AlGaInP	590	water clear	50	150	120°	
KPT-1608SGC	GaP	568	water clear	4	15	120°	
KPT-1608MGC	AlGaInP	570	water clear	36	70	120°	
KPT-1608CGCK	AlGaInP	570	water clear	10	50	120°	
KPT-1608ZGC	InGaIn	525	water clear	110	300	120°	
KPT-1608ZGC-E	InGaIn	525	water clear	280	650	120°	
KPT-1608ZGC-G	InGaIn	525	water clear	380	700	120°	
KPT-1608QBC-D	InGaIn	470	water clear	36	100	120°	
KPT-1608QBC-F	InGaIn	465	water clear	50	150	120°	
KPT-1608QBC-G	InGaIn	465	water clear	70	180	120°	
KPTD-1608SURCK	AlGaInP	630	water clear	480	700	60°	
KPTD-1608SECK	AlGaInP	601	water clear	480	800	60°	
KPTD-1608SYCK	AlGaInP	590	water clear	280	480	60°	
KPTD-1608MGC	AlGaInP	570	water clear	110	250	60°	
KPTD-1608CGCK	AlGaInP	570	water clear	70	180	60°	
KPTD-1608ZGC	InGaIn	525	water clear	380	780	60°	
KPTD-1608ZGC-E	InGaIn	525	water clear	480	850	60°	
KPTD-1608ZGC-G	InGaIn	525	water clear	650	1200	60°	
KPTD-1608QBC-D	InGaIn	470	water clear	70	250	40°	
KPTD-1608QBC-F	InGaIn	465	water clear	110	270	40°	
KPTD-1608QBC-G	InGaIn	465	water clear	180	300	40°	
KP-2012EC	GaAsP/GaP	625	water clear	4	15	120°	2.0mm x 1.25mm x 1.1mm (0805)  KP-2012    Units : mm(inch) Tolerance : ±0.1(0.004)
KP-2012SRC-PRV	GaAlAs	640	water clear	36	100	120°	
KP-2012SURCK	AlGaInP	630	water clear	70	220	120°	
KP-2012SECK	AlGaInP	601	water clear	70	240	120°	
KP-2012YC	GaAsP/GaP	588	water clear	2.6	8	120°	
KP-2012SYCK	AlGaInP	590	water clear	50	150	120°	
KP-2012SGC	GaP	568	water clear	4	15	120°	
KP-2012MGC	AlGaInP	570	water clear	36	70	120°	
KP-2012CGCK	AlGaInP	570	water clear	10	50	120°	
KP-2012ZGC	InGaIn	525	water clear	110	300	120°	
KP-2012ZGC-E	InGaIn	525	water clear	280	650	120°	
KP-2012ZGC-G	InGaIn	525	water clear	380	700	120°	
KP-2012QBC-D	InGaIn	470	water clear	36	100	120°	
KP-2012QBC-F	InGaIn	465	water clear	50	150	120°	
KP-2012QBC-G	InGaIn	465	water clear	70	180	120°	



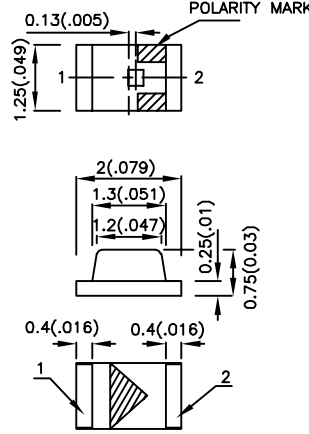
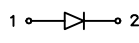

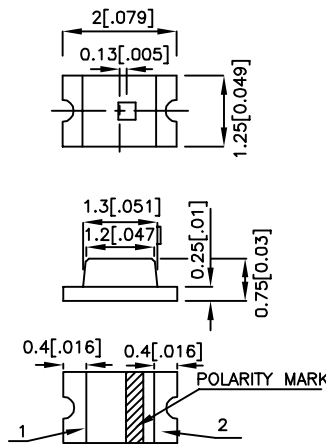
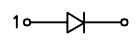
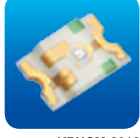
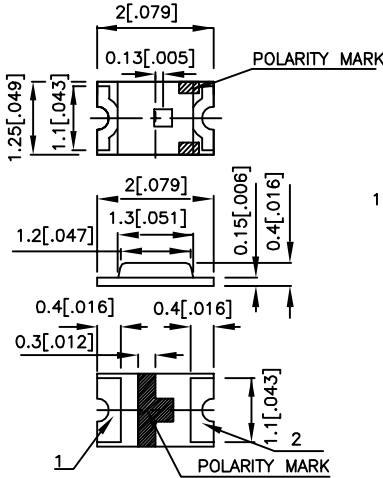
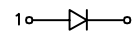
NOTE:  
1.KP series custom-made is available upon request.

## TOP-EMITTING CHIP SMD LED

PART NUMBER	MATERIAL	$\lambda_D$ (nm)	LENS TYPE	Iv (mcd) @20mA		VIEWING ANGLE	DIMENSION	
				MIN.	TYP.			
KPT-2012SURCK	AlGaInP	630	water clear	70	220	120°	<p>2.0mm x 1.25mm x 0.75mm</p>  <p>KPT-2012</p>   <p>Units : mm(inch) Tolerance : ±0.1(0.004)</p>	
KPT-2012SECK	AlGaInP	601	water clear	70	240	120°		
KPT-2012SYCK	AlGaInP	590	water clear	50	150	120°		
KPT-2012MGC	AlGaInP	570	water clear	36	70	120°		
KPT-2012CGCK	AlGaInP	570	water clear	10	50	120°		
KPT-2012ZGC	InGaN	525	water clear	110	300	120°		
KPT-2012ZGC-E	InGaN	525	water clear	280	650	120°		
KPT-2012ZGC-G	InGaN	525	water clear	380	700	120°		
KPT-2012QBC-D	InGaN	470	water clear	36	100	120°		
KPT-2012QBC-F	InGaN	465	water clear	50	150	120°		
KPT-2012QBC-G	InGaN	465	water clear	70	180	120°		
KPTC-2012SURCK	AlGaInP	630	water clear	70	220	120°		<p>2.0mm x 1.25mm x 0.75mm</p>  <p>KPTC-2012</p>   <p>Units : mm(inch) Tolerance : ±0.1(0.004)</p>
KPTC-2012SECK	AlGaInP	601	water clear	70	240	120°		
KPTC-2012SYCK	AlGaInP	590	water clear	50	150	120°		
KPTC-2012MGC	AlGaInP	570	water clear	36	70	120°		
KPTC-2012CGCK	AlGaInP	570	water clear	10	50	120°		
KPTC-2012ZGC	InGaN	525	water clear	110	300	120°		
KPTC-2012ZGC-E	InGaN	525	water clear	280	650	120°		
KPTC-2012ZGC-G	InGaN	525	water clear	380	700	120°		
KPTC-2012QBC-D	InGaN	470	water clear	36	100	120°		
KPTC-2012QBC-F	InGaN	465	water clear	50	150	120°		
KPTC-2012QBC-G	InGaN	465	water clear	70	180	120°		
KPHCM-2012SURCK	AlGaInP	630	water clear	70	220	110°	<p>2.0mm x 1.25mm x 0.4mm (0805 Super Thin)</p>  <p>KPHCM-2012</p>   <p>Units : mm(inch) Tolerance : ±0.1(0.004)</p>	
KPHCM-2012SECK	AlGaInP	601	water clear	70	240	110°		
KPHCM-2012SYCK	AlGaInP	590	water clear	50	150	110°		
KPHCM-2012CGCK	AlGaInP	570	water clear	10	50	110°		
KPHCM-2012ZGC	InGaN	525	water clear	110	300	110°		
KPHCM-2012ZGC-E	InGaN	525	water clear	280	650	110°		
KPHCM-2012ZGC-G	InGaN	525	water clear	380	700	110°		
KPHCM-2012QBC-D	InGaN	470	water clear	36	100	110°		
KPHCM-2012QBC-F	InGaN	465	water clear	50	150	110°		
KPHCM-2012QBC-G	InGaN	465	water clear	70	180	110°		

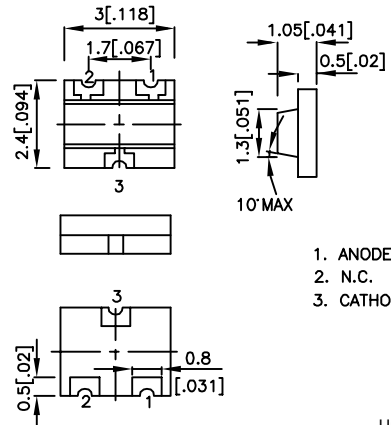

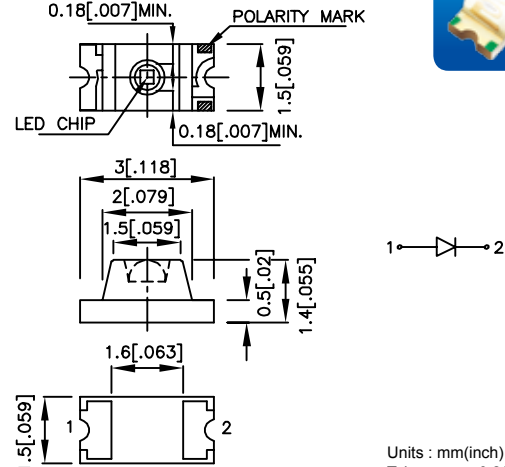

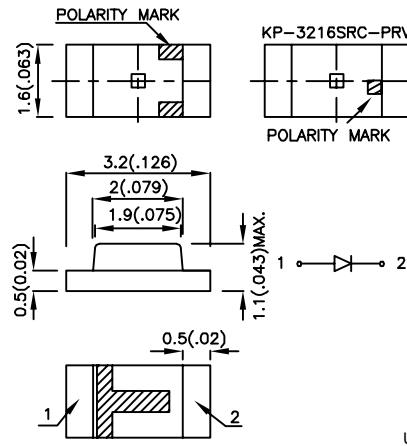
NOTE:  
1.KP series custom-made is available upon request.

TOP-EMITTING CHIP SMD LED

PART NUMBER	MATERIAL	λD (nm)	LENS TYPE	Iv (mcd) @20mA		VIEWING ANGLE 2θ1/2	DIMENSION	
				MIN.	TYP.			
KP-23SURCK-F	AlGaInP	630	water clear	70	220	120°	<p>3.0mm x 2.4mm x 1.05mm</p>  <p>KP-23-F</p>  <p>Units : mm(inch) Tolerance : ±0.2(0.008)</p>	
KP-23SECK-F	AlGaInP	601	water clear	70	240	120°		
KP-23SYCK-F	AlGaInP	590	water clear	50	150	120°		
KP-23MGC-F	AlGaInP	570	water clear	36	70	120°		
KP-23CGCK-F	AlGaInP	570	water clear	18	50	120°		
KP-23ZGC-F	InGaN	525	water clear	110	380	120°		
KP-23ZGC-E-F	InGaN	525	water clear	280	650	120°		
KP-23ZGC-G-F	InGaN	525	water clear	380	700	120°		
KP-23QBC-D-F	InGaN	470	water clear	36	100	120°		
KP-23QBC-F-F	InGaN	465	water clear	50	120	120°		
KP-23QBC-G-F	InGaN	465	water clear	70	180	120°		
KPL-3015SURCK	AlGaInP	630	water clear	280	500	70°		<p>3.0mm x 1.5mm x 1.4mm (1106)</p>  <p>KPL-3015</p>  <p>Units : mm(inch) Tolerance : ±0.2(0.008)</p>
KPL-3015SECK	AlGaInP	601	water clear	280	550	70°		
KPL-3015SYCK	AlGaInP	590	water clear	110	300	70°		
KPL-3015MGC	AlGaInP	570	water clear	70	140	70°		
KPL-3015CGCK	AlGaInP	570	water clear	50	100	70°		
KPL-3015ZGC	InGaN	525	water clear	380	850	70°		
KPL-3015ZGC-E	InGaN	525	water clear	650	1300	70°		
KPL-3015ZGC-G	InGaN	525	water clear	900	1500	70°		
KPL-3015QBC-D	InGaN	470	water clear	70	180	70°		
KPL-3015QBC-F	InGaN	465	water clear	110	250	70°		
KPL-3015QBC-G	InGaN	465	water clear	180	320	70°		
KP-3216EC	GaAsP/GaP	625	water clear	4	15	120°	<p>3.2mm x 1.6mm x 1.1mm (1206)</p>  <p>KP-3216</p>  <p>Units : mm(inch) Tolerance : ±0.2(0.008)</p>	
KP-3216SRC-PRV	GaAlAs	640	water clear	36	100	120°		
KP-3216SURCK	AlGaInP	630	water clear	70	220	120°		
KP-3216SECK	AlGaInP	601	water clear	70	240	120°		
KP-3216YC	GaAsP/GaP	588	water clear	2.6	8	120°		
KP-3216SYCK	AlGaInP	590	water clear	50	150	120°		
KP-3216SGC	GaP	568	water clear	4	15	120°		
KP-3216MGC	AlGaInP	570	water clear	36	70	120°		
KP-3216CGCK	AlGaInP	570	water clear	10	50	120°		
KP-3216ZGC	InGaN	525	water clear	110	300	120°		
KP-3216ZGC-E	InGaN	525	water clear	280	650	120°		
KP-3216ZGC-G	InGaN	525	water clear	380	700	120°		
KP-3216QBC-D	InGaN	470	water clear	36	100	120°		
KP-3216QBC-F	InGaN	465	water clear	50	150	120°		
KP-3216QBC-G	InGaN	465	water clear	70	180	120°		

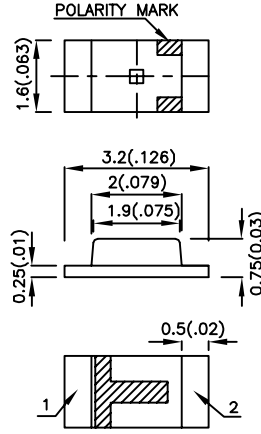
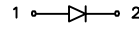

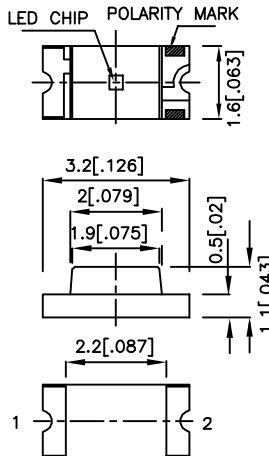
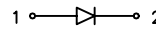
NOTE:  
1.KP series custom-made is available upon request.

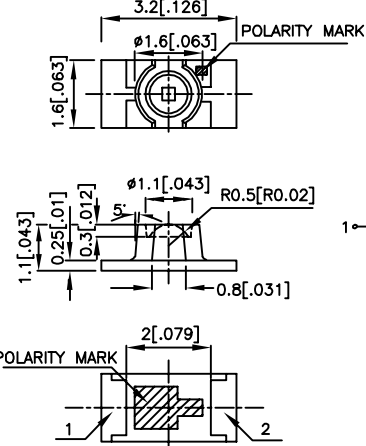
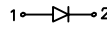
## TOP-EMITTING CHIP SMD LED

PART NUMBER	MATERIAL	$\lambda_D$ (nm)	LENS TYPE	Iv (mcd) @20mA		VIEWING ANGLE	DIMENSION	
				MIN.	TYP.			
KPT-3216SURCK	AlGaInP	630	water clear	70	220	120°	3.2mm x 1.6mm x 0.75mm (1206 Super Thin)  KPT-3216   Units : mm(inch) Tolerance : ±0.2(0.008)	
KPT-3216SECK	AlGaInP	601	water clear	70	240	120°		
KPT-3216SYCK	AlGaInP	590	water clear	50	150	120°		
KPT-3216MGC	AlGaInP	570	water clear	36	70	120°		
KPT-3216CGCK	AlGaInP	570	water clear	10	50	120°		
KPT-3216ZGC	InGaN	525	water clear	110	300	120°		
KPT-3216ZGC-E	InGaN	525	water clear	280	650	120°		
KPT-3216ZGC-G	InGaN	525	water clear	380	700	120°		
KPT-3216QBC-D	InGaN	470	water clear	36	100	120°		
KPT-3216QBC-F	InGaN	465	water clear	50	150	120°		
KPT-3216QBC-G	InGaN	465	water clear	70	180	120°		
KPC-3216SURCK	AlGaInP	630	water clear	70	220	120°		3.2mm x 1.6mm x 1.1mm (1206)  KPC-3216   Units : mm(inch) Tolerance : ±0.2(0.008)
KPC-3216SECK	AlGaInP	601	water clear	70	240	120°		
KPC-3216SYCK	AlGaInP	590	water clear	50	150	120°		
KPC-3216MGC	AlGaInP	570	water clear	36	70	120°		
KPC-3216CGCK	AlGaInP	570	water clear	10	50	120°		
KPC-3216ZGC	InGaN	525	water clear	110	300	120°		
KPC-3216ZGC-E	InGaN	525	water clear	280	650	120°		
KPC-3216ZGC-G	InGaN	525	water clear	380	700	120°		
KPC-3216QBC-D	InGaN	470	water clear	36	100	120°		
KPC-3216QBC-F	InGaN	465	water clear	50	150	120°		
KPC-3216QBC-G	InGaN	465	water clear	70	180	120°		
KPTL-3216SURCK	AlGaInP	630	water clear	280	550	70°	3.2mm x 1.6mm x 1.1mm (1206)  KPTL-3216   Units : mm(inch) Tolerance : 0.1(0.004)	
KPTL-3216SECK	AlGaInP	601	water clear	280	600	70°		
KPTL-3216SYCK	AlGaInP	590	water clear	110	350	70°		
KPTL-3216CGCK	AlGaInP	570	water clear	70	200	70°		
KPTL-3216ZGC	InGaN	525	water clear	480	1100	70°		
KPTL-3216ZGC-E	InGaN	525	water clear	650	1600	70°		
KPTL-3216ZGC-G	InGaN	525	water clear	900	1800	70°		
KPTL-3216QBC-D	InGaN	470	water clear	110	300	70°		
KPTL-3216QBC-F	InGaN	465	water clear	180	360	70°		
KPTL-3216QBC-G	InGaN	465	water clear	280	400	70°		

NOTE:  
1.KP series custom-made is available upon request.

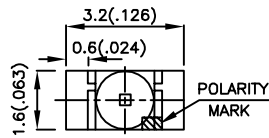
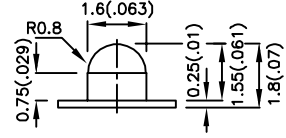
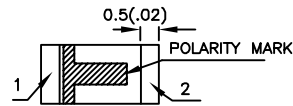
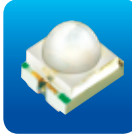
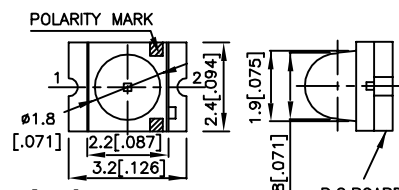
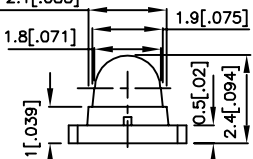
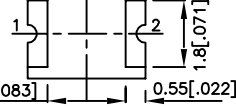
TOP-EMITTING CHIP SMD LED

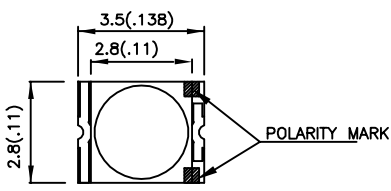
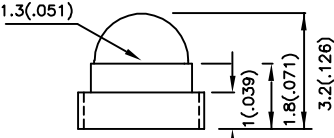
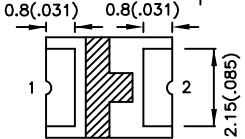
PART NUMBER	MATERIAL	$\lambda_D$ (nm)	LENS TYPE	Iv (mcd) @20mA		VIEWING ANGLE 2 $\theta$ 1/2	DIMENSION	
				MIN.	TYP.			
KPTD-3216SURCK	AlGaInP	630	water clear	480	1500	50°	3.2mm x 1.6mm x 1.8mm (1206 Dome Lens)  KPTD-3216    Units : mm(inch) Tolerance : ±0.2(0.008)	
KPTD-3216SECK	AlGaInP	601	water clear	650	1600	50°		
KPTD-3216SYCK	AlGaInP	590	water clear	380	900	50°		
KPTD-3216MGC	AlGaInP	570	water clear	110	450	50°		
KPTD-3216CGCK	AlGaInP	570	water clear	110	300	50°		
KPTD-3216ZGC	InGaN	525	water clear	900	2000	50°		
KPTD-3216ZGC-E	InGaN	525	water clear	2200	3500	50°		
KPTD-3216ZGC-G	InGaN	525	water clear	2500	4000	50°		
KPTD-3216QBC-D	InGaN	470	water clear	280	500	40°		
KPTD-3216QBC-F	InGaN	465	water clear	380	850	40°		
KPTD-3216QBC-G	InGaN	465	water clear	480	900	40°		
KPD-3224SURCK	AlGaInP	630	water clear	650	2500	20°		3.2mm x 2.4mm x 2.4mm (Dome Lens)  KPD-3224    Units : mm(inch) Tolerance : ±0.1(0.004)
KPD-3224SECK	AlGaInP	601	water clear	900	2600	20°		
KPD-3224SYCK	AlGaInP	590	water clear	480	1400	20°		
KPD-3224MGC	AlGaInP	570	water clear	380	700	20°		
KPD-3224CGCK	AlGaInP	570	water clear	280	700	20°		
KPD-3224ZGC	InGaN	525	water clear	1200	2400	20°		
KPD-3224ZGC-E	InGaN	525	water clear	2800	5000	20°		
KPD-3224ZGC-G	InGaN	525	water clear	3300	5300	20°		
KPD-3224QBC-D	InGaN	470	water clear	380	900	20°		
KPD-3224QBC-F	InGaN	465	water clear	480	1200	20°		
KPD-3224QBC-G	InGaN	465	water clear	650	1400	20°		
KPED-3528SURCK	AlGaInP	630	water clear	380	800	40°	3.5mm x 2.8mm x 3.2mm (Dome Lens)  KPED-3528    Units : mm(inch) Tolerance : ±0.2(0.008)	
KPED-3528SECK	AlGaInP	601	water clear	480	900	40°		
KPED-3528SYCK	AlGaInP	590	water clear	180	500	40°		
KPED-3528MGC	AlGaInP	570	water clear	110	250	40°		
KPED-3528CGCK	AlGaInP	570	water clear	70	200	40°		
KPED-3528ZGC	InGaN	525	water clear	480	1400	40°		
KPED-3528ZGC-E	InGaN	525	water clear	1800	2700	40°		
KPED-3528ZGC-G	InGaN	525	water clear	2200	3000	40°		
KPED-3528QBC-D	InGaN	470	water clear	180	500	40°		
KPED-3528QBC-F	InGaN	465	water clear	380	700	40°		
KPED-3528QBC-G	InGaN	465	water clear	480	800	40°		



NOTE:  
1.KP series custom-made is available upon request.

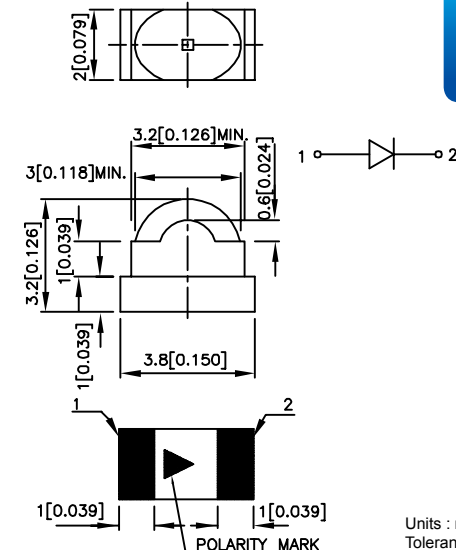

## TOP-EMITTING CHIP SMD LED

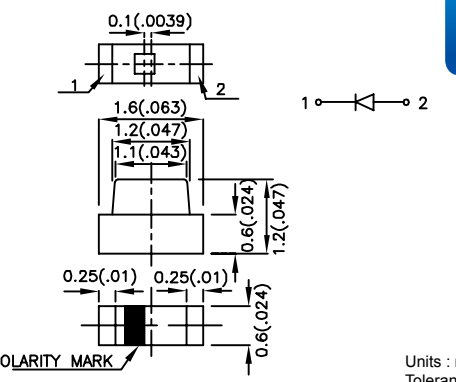

PART NUMBER	MATERIAL	$\lambda_D$ (nm)	LENS TYPE	Iv (mcd) @20mA		VIEWING ANGLE 2 $\theta$ 1/2	DIMENSION
				MIN.	TYP.		
KPED-3820SURCK	AlGaInP	630	water clear	280	700	60°(H) 35°(V)	3.8mm x 2.0mm x 3.2mm (Dome Lens)   <p>Units : mm(inch) Tolerance : <math>\pm 0.2(0.008)</math></p>
KPED-3820SECK	AlGaInP	601	water clear	280	800	60°(H) 35°(V)	
KPED-3820SYCK	AlGaInP	590	water clear	110	450	60°(H) 35°(V)	
KPED-3820MGC	AlGaInP	570	water clear	110	250	60°(H) 35°(V)	
KPED-3820CGCK	AlGaInP	570	water clear	70	170	60°(H) 35°(V)	
KPED-3820ZGC	InGaN	525	water clear	480	1200	60°(H) 35°(V)	
KPED-3820ZGC-E	InGaN	525	water clear	1500	2500	60°(H) 35°(V)	
KPED-3820ZGC-G	InGaN	525	water clear	1800	2700	60°(H) 35°(V)	
KPED-3820QBC-D	InGaN	470	water clear	110	300	60°(H) 35°(V)	
KPED-3820QBC-F	InGaN	465	water clear	280	450	60°(H) 35°(V)	
KPED-3820QBC-G	InGaN	465	water clear	380	650	60°(H) 35°(V)	

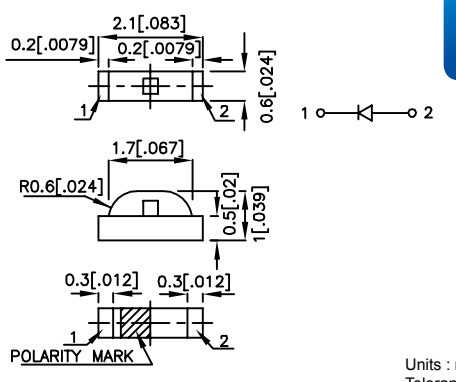
## RIGHT ANGLE SMD LED

PART NUMBER	MATERIAL	$\lambda_D$ (nm)	LENS TYPE	Iv (mcd) @20mA		VIEWING ANGLE 2 $\theta$ 1/2	DIMENSION
				MIN.	TYP.		
KPA-1606SURCK	AlGaInP	630	water clear	110	250	110°	1.6mm x 0.6mm x 1.2mm (0602 Right Angle)   <p>Units : mm(inch) Tolerance : <math>\pm 0.1(0.004)</math></p>
KPA-1606SECK	AlGaInP	601	water clear	110	300	110°	
KPA-1606SYCK	AlGaInP	590	water clear	50	150	110°	
KPA-1606CGCK	AlGaInP	570	water clear	18	60	110°	
KPA-1606ZGC	InGaN	525	water clear	110	350	110°	
KPA-1606ZGC-E	InGaN	525	water clear	280	600	110°	
KPA-1606ZGC-G	InGaN	525	water clear	380	650	110°	
KPA-1606QBC-D	InGaN	470	water clear	36	90	110°	
KPA-1606QBC-F	InGaN	465	water clear	50	120	110°	
KPA-1606QBC-G	InGaN	465	water clear	70	150	110°	
KPA-2106SURCK	AlGaInP	630	water clear	110	250	120°	2.1mm x 0.6mm x 1.0mm (0802 Right Angle)   <p>Units : mm(inch) Tolerance : <math>\pm 0.1(0.004)</math></p>
KPA-2106SECK	AlGaInP	601	water clear	110	300	120°	
KPA-2106SYCK	AlGaInP	590	water clear	50	150	120°	
KPA-2106MGC	AlGaInP	570	water clear	36	80	120°	
KPA-2106CGCK	AlGaInP	570	water clear	18	60	120°	
KPA-2106ZGC	InGaN	525	water clear	110	350	120°	
KPA-2106ZGC-E	InGaN	525	water clear	280	600	120°	
KPA-2106ZGC-G	InGaN	525	water clear	380	650	120°	
KPA-2106QBC-D	InGaN	470	water clear	36	90	120°	
KPA-2106QBC-F	InGaN	465	water clear	50	120	120°	
KPA-2106QBC-G	InGaN	465	water clear	70	150	120°	



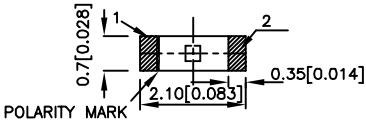
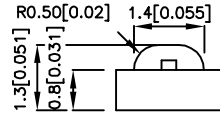
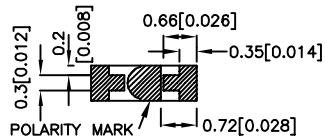
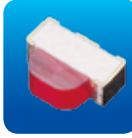
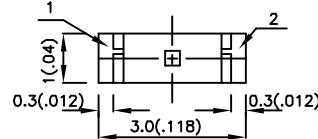
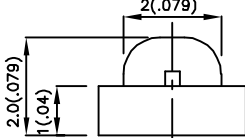
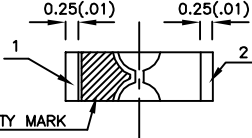

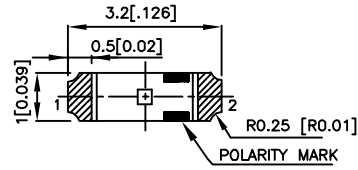
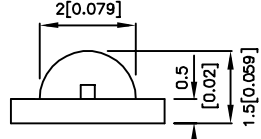
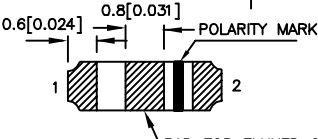

NOTE:  
1.KP series custom-made is available upon request.

RIGHT ANGLE SMD LED

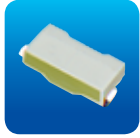
PART NUMBER	MATERIAL	$\lambda_D$ (nm)	LENS TYPE	Iv (mcd) @20mA		VIEWING ANGLE 2 $\theta$ 1/2	DIMENSION	
				MIN.	TYP.			
KPJA-2107SURCK	AlGaInP	630	water clear	110	250	120°	<p>2.1mm x 0.7mm x 1.3mm (0802 Right Angle)</p>  <p>KPJA-2107</p>  <p>POLARITY MARK</p>   <p>POLARITY MARK</p> <p>Units : mm(inch) Tolerance : 0.15(0.006)</p>	
KPJA-2107SECK	AlGaInP	601	water clear	110	300	120°		
KPJA-2107SYCK	AlGaInP	590	water clear	50	150	120°		
KPJA-2107MGC	AlGaInP	570	water clear	36	80	120°		
KPJA-2107CGCK	AlGaInP	570	water clear	18	60	120°		
KPJA-2107ZGC	InGaN	525	water clear	110	350	120°		
KPJA-2107ZGC-E	InGaN	525	water clear	280	600	120°		
KPJA-2107ZGC-G	InGaN	525	water clear	380	650	120°		
KPJA-2107QBC-D	InGaN	470	water clear	36	90	120°		
KPJA-2107QBC-F	InGaN	465	water clear	50	120	120°		
KPJA-2107QBC-G	InGaN	465	water clear	70	150	120°		
KPA-3010SURCK	AlGaInP	630	water clear	110	250	120°		<p>3.0mm x 1.0mm x 2.0mm (1104 Right Angle)</p>  <p>KPA-3010</p>    <p>POLARITY MARK</p> <p>Units : mm(inch) Tolerance : ±0.15(0.006)</p>
KPA-3010SECK	AlGaInP	601	water clear	110	300	120°		
KPA-3010SYCK	AlGaInP	590	water clear	50	150	120°		
KPA-3010MGC	AlGaInP	570	water clear	36	80	120°		
KPA-3010CGCK	AlGaInP	570	water clear	18	60	120°		
KPA-3010ZGC	InGaN	525	water clear	110	350	120°		
KPA-3010ZGC-E	InGaN	525	water clear	280	600	120°		
KPA-3010ZGC-G	InGaN	525	water clear	380	650	120°		
KPA-3010QBC-D	InGaN	470	water clear	36	90	120°		
KPA-3010QBC-F	InGaN	465	water clear	50	120	120°		
KPA-3010QBC-G	InGaN	465	water clear	70	150	120°		
KPA-3210SURCK	AlGaInP	630	water clear	110	250	120°	<p>3.2mm x 1.0mm x 1.5mm (1304 Right Angle)</p>  <p>KPA-3210</p>  <p>POLARITY MARK</p>   <p>POLARITY MARK</p> <p>PAD FOR FLUXED ONLY</p> <p>Units : mm(inch) Tolerance : ±0.1(0.004)</p>	
KPA-3210SECK	AlGaInP	601	water clear	110	300	120°		
KPA-3210SYCK	AlGaInP	590	water clear	50	150	120°		
KPA-3210MGC	AlGaInP	570	water clear	36	80	120°		
KPA-3210CGCK	AlGaInP	570	water clear	18	60	120°		
KPA-3210ZGC	InGaN	525	water clear	110	350	120°		
KPA-3210ZGC-E	InGaN	525	water clear	280	600	120°		
KPA-3210ZGC-G	InGaN	525	water clear	380	650	120°		
KPA-3210QBC-D	InGaN	470	water clear	36	90	120°		
KPA-3210QBC-F	InGaN	465	water clear	50	120	120°		
KPA-3210QBC-G	InGaN	465	water clear	70	150	120°		

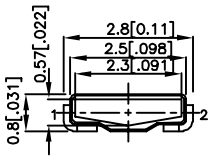
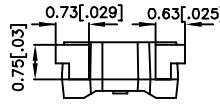
NOTE:  
1.KP series custom-made is available upon request.

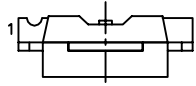
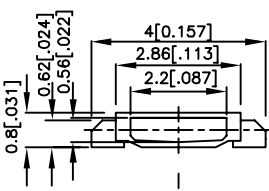
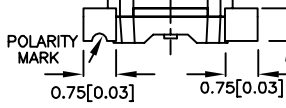
## RIGHT ANGLE SMD LED

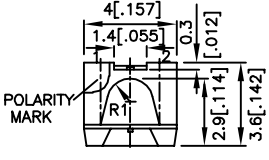
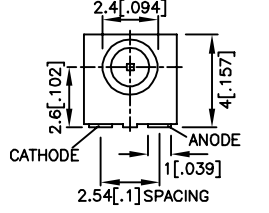
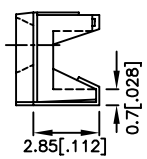





PART NUMBER	MATERIAL	$\lambda_D$ (nm)	LENS TYPE	Iv (mcd) @20mA		VIEWING ANGLE	DIMENSION
				MIN.	TYP.		
KA-2810ASURSK	AlGaN <sub>P</sub>	630	water clear	70	200	110°	2.8mm x 0.8mm Right Angle  KA-2810A    Units : mm(inch) Tolerance : ±0.1(0.004)
KA-2810ASESK	AlGaN <sub>P</sub>	601	water clear	110	270	110°	
KA-2810ASYSK	AlGaN <sub>P</sub>	590	water clear	110	200	110°	
KA-2810ACGSK	AlGaN <sub>P</sub>	570	water clear	36	70	110°	
KA-2810AZGS	InGa <sub>N</sub>	525	water clear	380	750	110°	
KA-2810AZGS-E	InGa <sub>N</sub>	525	water clear	650	1300	110°	
KA-2810AZGS-G	InGa <sub>N</sub>	525	water clear	900	1500	110°	
KA-2810AQBS-D	InGa <sub>N</sub>	470	water clear	50	120	110°	
KA-2810AQBS-F	InGa <sub>N</sub>	465	water clear	110	250	110°	
KA-2810AQBS-G	InGa <sub>N</sub>	465	water clear	180	350	110°	
KA-4008SURSK	AlGaN <sub>P</sub>	630	water clear	110	300	120°	4.0mm x 0.8mm Right Angle  KA-4008    Units : mm(inch) Tolerance : ±0.1(0.004)
KA-4008SESK	AlGaN <sub>P</sub>	601	water clear	110	350	120°	
KA-4008SYSK	AlGaN <sub>P</sub>	590	water clear	70	250	120°	
KA-4008ZGS	InGa <sub>N</sub>	525	water clear	280	600	120°	
KA-4008ZGS-E	InGa <sub>N</sub>	525	water clear	650	1200	120°	
KA-4008ZGS-G	InGa <sub>N</sub>	525	water clear	900	1400	120°	
KA-4008QBS-D	InGa <sub>N</sub>	470	water clear	50	100	120°	
KA-4008QBS-F	InGa <sub>N</sub>	465	water clear	110	250	120°	
KA-4008QBS-G	InGa <sub>N</sub>	465	water clear	180	300	120°	
KA-4040SURCKT	AlGaN <sub>P</sub>	630	water clear	70	250	90°	4.0mm x 4.0mm Right Angle  KA-4040    Units : mm(inch) Tolerance : ±0.25(0.01)
KA-4040SECKT	AlGaN <sub>P</sub>	601	water clear	110	400	90°	
KA-4040SYCKT	AlGaN <sub>P</sub>	590	water clear	70	250	90°	
KA-4040MGCT	AlGaN <sub>P</sub>	570	water clear	50	100	90°	
KA-4040CGCKT	AlGaN <sub>P</sub>	570	water clear	36	70	90°	
KA-4040ZGCT	InGa <sub>N</sub>	525	water clear	380	600	90°	
KA-4040ZGCT-E	InGa <sub>N</sub>	525	water clear	480	1300	90°	
KA-4040ZGCT-G	InGa <sub>N</sub>	525	water clear	650	1500	90°	
KA-4040QBCT-D	InGa <sub>N</sub>	470	water clear	70	150	90°	
KA-4040QBCT-F	InGa <sub>N</sub>	465	water clear	110	220	90°	
KA-4040QBCT-G	InGa <sub>N</sub>	465	water clear	180	300	90°	

MULTI-COLOR SMD LED

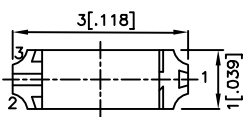
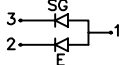
PART NUMBER	MATERIAL	$\lambda_D$ (nm)	LENS TYPE	Iv (mcd) @20mA		VIEWING ANGLE 2 $\theta$ 1/2	DIMENSION
				MIN.	TYP.		
KPTB-1612ESGC	GaAsP/GaP	625	water clear	4	15	120°	<p>1.6mm x 1.25mm x 0.65mm (0605 Bi-Color)</p> <p>Units : mm(inch) Tolerance : ±0.2(0.008)</p>
	GaP	568		4	15		
KPTB-1612SURKCGKC	AlGaInP	630	water clear	70	220	120°	
	AlGaInP	570		18	50		
KPTB-1612SURKQBDC	AlGaInP	630	water clear	70	220	120°	
	InGaN	470		36	90		
KPTB-1612SYKCGKC	AlGaInP	590	water clear	50	150	120°	
	AlGaInP	570		18	50		
KPTB-1612QBDSEKC	InGaN	470	water clear	36	90	120°	
	AlGaInP	601		70	240		
KPTB-1615ESGC	GaAsP/GaP	625	water clear	4	15	120°	<p>1.6mm x 1.5mm x 0.7mm (0606 Bi-Color)</p> <p>Units : mm(inch) Tolerance : ±0.2(0.008)</p>
	GaP	568		4	15		
KPTB-1615SURKSGC	AlGaInP	630	water clear	70	220	120°	
	GaP	568		4	15		
KPTB-1615SURKCGKC	AlGaInP	630	water clear	70	220	120°	
	AlGaInP	570		18	50		
KPTB-1615SURKQBDC	AlGaInP	630	water clear	70	220	120°	
	InGaN	470		36	90		
KPTB-1615YSGC	GaAsP/GaP	588	water clear	2.6	8	120°	
	GaP	568		4	15		
KPTB-1615SYKCGKC	AlGaInP	590	water clear	50	150	120°	
	AlGaInP	570		18	50		
KPTB-1615SGNC	GaP	568	water clear	4	15	120°	
	GaAsP/GaP	610		4	15		
KPHBM-2012SURKCGKC	AlGaInP	630	water clear	70	220	120°	<p>2.0mm x 1.25mm x 0.45mm (Bi-Color)</p> <p>Units : mm(inch) Tolerance : ±0.1(0.004)</p>
	AlGaInP	570		18	50		
KPHBM-2012CGKSEKC	AlGaInP	570	water clear	18	50	120°	
	AlGaInP	601		110	250		
KPHBM-2012QBDSURKC	InGaN	470	water clear	36	90	120°	
	AlGaInP	630		70	220		
KPHBM-2012QBDCGKC	InGaN	470	water clear	36	90	120°	
	AlGaInP	570		18	50		

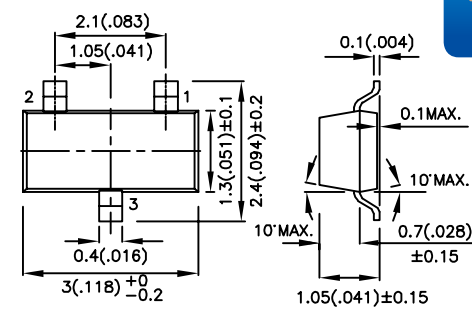
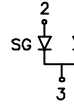
NOTE:  
1.KP series custom-made is available upon request.

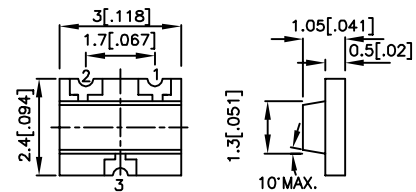
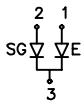
## MULTI-COLOR SMD LED

PART NUMBER	MATERIAL	$\lambda_D$ (nm)	LENS TYPE	Iv (mcd) @20mA		VIEWING ANGLE	DIMENSION	
				MIN.	TYP.			
KPBVA-3010ESGC	GaAsP/GaP	625	water clear	7	15	140°	3.0mm x 1.0mm x 2.0mm (1104 Right Angle, Bi-Color)   	
	GaP	568		7	15			
KPBVA-3010SRSGC-PRV	GaAlAs	640	water clear	50	140	140°		
	GaP	568		7	20			
KPBVA-3010SURKSGC	AlGaInP	630	water clear	110	300	140°		
	GaP	568		7	15			
KPBVA-3010SURKMGKC	AlGaInP	630	water clear	110	300	140°		
	AlGaInP	570		36	80			
KPBVA-3010SURKQBDC	AlGaInP	630	water clear	110	300	140°		
	InGaN	470		36	90			
KPBVA-3010YSGC	GaAsP/GaP	588	water clear	2.6	8	140°		
	GaP	568		7	15			
KPBVA-3010SYKCGKC	AlGaInP	590	water clear	50	150	140°		
	AlGaInP	570		18	50			
KM-23ESGW	GaAsP/GaP	625	white diffused	4	15	140°	SOT-23 Surface Mount LED Lamp (3mm x 1.3mm)   	
	GaP	568		4	15			
KM-23ESGC	GaAsP/GaP	625	water clear	4	15	140°		
	GaP	568		4	15			
KP-23ESGC	GaAsP/GaP	625	water clear	7	20	120°		3.0mm x 2.4mm x 1.05mm   
	GaP	568		7	20			
KP-23YSGC	GaAsP/GaP	588	water clear	2.6	8	120°		
	GaP	568		7	20			

NOTE:  
1.KP series custom-made is available upon request.

MULTI-COLOR SMD LED

PART NUMBER	MATERIAL	$\lambda_D$ (nm)	LENS TYPE	Iv (mcd) @20mA		VIEWING ANGLE 2 $\theta$ 1/2	DIMENSION
				MIN.	TYP.		
KPBL-3025ESGC	GaAsP/GaP	625	water clear	4	15	120°	<p>3.0mm x 2.5mm x 1.1mm (1109 Bi-Color)</p> <p>Units: mm(inch) Tolerance: ±0.2(0.008)</p>
	GaP	568		4	15		
KPBL-3025EYC	GaAsP/GaP	625	water clear	4	15	120°	
	GaAsP/GaP	588		2.6	8		
KPBL-3025SRSGC-PRV	GaAlAs	640	water clear	36	100	120°	
	GaP	568		4	15		
KPBL-3025SRCGKC-PRV	GaAlAs	640	water clear	36	100	120°	
	AlGaInP	570		18	50		
KPBL-3025NSGC	GaAsP/GaP	610	water clear	4	15	120°	
	GaP	568		4	15		
KPBL-3025SURKCGKC	AlGaInP	630	water clear	70	220	120°	
	AlGaInP	570		18	50		
KPBL-3025YSGC	GaAsP/GaP	588	water clear	2.6	8	120°	
	GaP	568		4	15		
KPBL-3025QBDSYKC	InGaIn	470	water clear	36	80	120°	
	AlGaInP	590		50	200		
KPBL-3025ESGC	GaAsP/GaP	625	water clear	7	20	100°	<p>3.0mm x 2.5mm x 1.4mm (1109 Bi-Color)</p> <p>Units: mm(inch) Tolerance: ±0.2(0.008)</p>
	GaP	568		7	20		
KPBL-3025EYC	GaAsP/GaP	625	water clear	7	20	100°	
	GaAsP/GaP	588		4	15		
KPBL-3025SRSGC-PRV	GaAlAs	640	water clear	36	100	100°	
	GaP	568		7	20		
KPBL-3025NSGC	GaAsP/GaP	610	water clear	7	20	100°	
	GaP	568		7	20		
KPBL-3025SURKCGKC	AlGaInP	630	water clear	180	500	100°	
	AlGaInP	570		50	150		
KPBL-3025YSGC	GaAsP/GaP	588	water clear	4	15	100°	
	GaP	568		7	20		
KPBL-3025QBDSYKC	InGaIn	470	water clear	50	180	100°	
	AlGaInP	590		70	150		
KPBD-3224ESGC	GaAsP/GaP	625	water clear	18	60	20°	<p>3.2mm x 2.4mm x 2.4mm (Dome Lens)</p> <p>Units: mm(inch) Tolerance: ±0.1(0.004)</p>
	GaP	568		10	60		
KPBD-3224SURKSGC	AlGaInP	630	water clear	380	1200	20°	
	GaP	568		10	60		
KPBD-3224SURKCGKC	AlGaInP	630	water clear	380	1200	20°	
	AlGaInP	570		110	300		
KPBD-3224YSGC	GaAsP/GaP	588	water clear	4	15	20°	
	GaP	568		10	60		
KPBD-3224SYKCGKC	AlGaInP	590	water clear	110	500	20°	
	AlGaInP	570		110	300		







NOTE:  
1.KP series custom-made is available upon request.

## MULTI-COLOR SMD LED

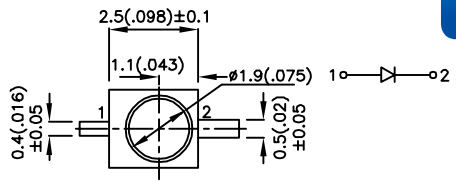
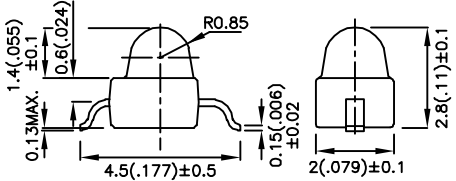
PART NUMBER	MATERIAL	$\lambda_D$ (nm)	LENS TYPE	Iv (mcd) @20mA		VIEWING ANGLE 2 $\theta$ 1/2	DIMENSION
				MIN.	TYP.		
KA-2735ESGCT	GaAsP/GaP	625	water clear	7	30	120°	2.7mm x 3.5mm (Bi-Color) 
	GaP	568		7	30		
KA-2735SURKMCT	AlGaInP	630	water clear	70	200	120°	
	AlGaInP	570		50	90		
KAA-3528SURKSYKCT	AlGaInP	630	water clear	110	350	120°	3.5mm x 2.8mm KAA-3528SURKSYKCT KAA-3528SURKCGKCT 
	AlGaInP	590		70	250		
KAA-3528SURKCGKCT	AlGaInP	630	water clear	110	350	120°	
	AlGaInP	570		36	100		
KAA-3528SURKZGQBDCT	AlGaInP	630	water clear	110	350	120°	
	InGaN	525		380	600		
	InGaN	470		36	80		

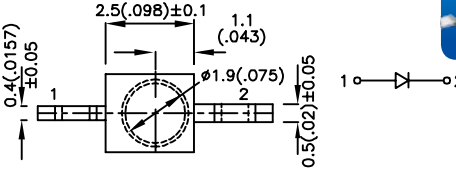
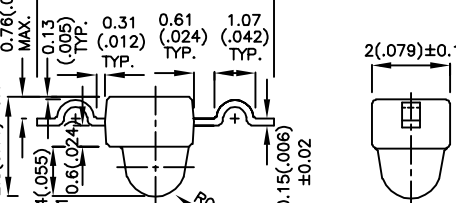

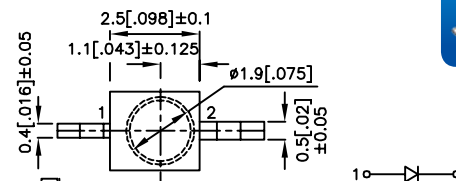
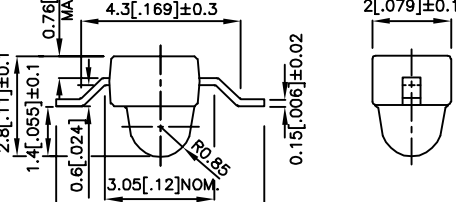
PART NUMBER	MATERIAL	$\lambda_D$ (nm)	LENS TYPE	Iv (mcd) @30mA *50mA		VIEWING ANGLE 2 $\theta$ 1/2	DIMENSION
				MIN.	TYP.		
KAAF-5060QBDSURKZGCT	InGaN	470	water clear	110	250	100°	5.0mm x 6.0 mm x 2.3mm 
	AlGaInP	630		*180	*350		
	InGaN	525		280	650		
KAAF-5060QBFSEEZGCT	InGaN	465	water clear	180	350	100°	
	AlGaInP	621		*650	*1000		
	InGaN	525		280	650		

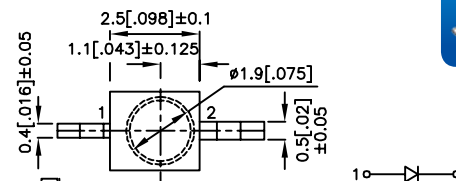
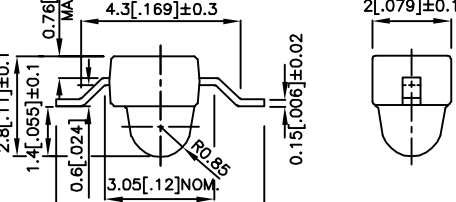
SUBMINIATURE SMD LED

PART NUMBER	MATERIAL	$\lambda_D$ (nm)	LENS TYPE	Iv (mcd) @20mA		VIEWING ANGLE 2 $\theta$ 1/2	DIMENSION	
				MIN.	TYP.			
KM2520SURCK03	AlGaInP	630	water clear	900	2400	20°	Subminiature Solid State Lamps Gull Wing Lead    Units : mm(inch) Tolerance : ±0.25(0.01)	
KM2520SECK03	AlGaInP	601	water clear	900	2500	20°		
KM2520SYCK03	AlGaInP	590	water clear	900	2200	20°		
KM2520MGC03	AlGaInP	570	water clear	380	900	20°		
KM2520CGCK03	AlGaInP	570	water clear	280	700	20°		
KM2520ZGC03	InGaN	525	water clear	1200	2500	20°		
KM2520ZGC-E03	InGaN	525	water clear	2200	4000	20°		
KM2520ZGC-G03	InGaN	525	water clear	2800	5000	20°		
KM2520QBC-D03	InGaN	470	water clear	180	500	20°		
KM2520QBC-F03	InGaN	465	water clear	480	850	20°		
KM2520QBC-G03	InGaN	465	water clear	650	1300	20°		
KM2520SURCK08	AlGaInP	630	water clear	900	2400	20°		Subminiature Solid State Lamps Yoke Lead    Units : mm(inch) Tolerance : ±0.25(0.01)
KM2520SECK08	AlGaInP	601	water clear	900	2500	20°		
KM2520SYCK08	AlGaInP	590	water clear	900	2200	20°		
KM2520MGC08	AlGaInP	570	water clear	380	900	20°		
KM2520CGCK08	AlGaInP	570	water clear	280	700	20°		
KM2520ZGC08	InGaN	525	water clear	1200	2500	20°		
KM2520ZGC-E08	InGaN	525	water clear	2200	4000	20°		
KM2520ZGC-G08	InGaN	525	water clear	2800	5000	20°		
KM2520QBC-D08	InGaN	470	water clear	180	500	20°	Subminiature Solid State Lamps Z-Bend Lead    Units : mm(inch) Tolerance : ±0.25(0.01)	
KM2520SURCK09	AlGaInP	630	water clear	900	2400	20°		
KM2520SECK09	AlGaInP	601	water clear	900	2500	20°		
KM2520SYCK09	AlGaInP	590	water clear	900	2200	20°		
KM2520MGC09	AlGaInP	570	water clear	380	900	20°		
KM2520CGCK09	AlGaInP	570	water clear	280	700	20°		
KM2520ZGC09	InGaN	525	water clear	1200	2500	20°		
KM2520ZGC-E09	InGaN	525	water clear	2200	4000	20°		
KM2520ZGC-G09	InGaN	525	water clear	2800	5000	20°		
KM2520QBC-D09	InGaN	470	water clear	180	500	20°	Subminiature Solid State Lamps Z-Bend Lead    Units : mm(inch) Tolerance : ±0.25(0.01)	
KM2520QBC-F09	InGaN	465	water clear	480	850	20°		
KM2520QBC-G09	InGaN	465	water clear	650	1300	20°		

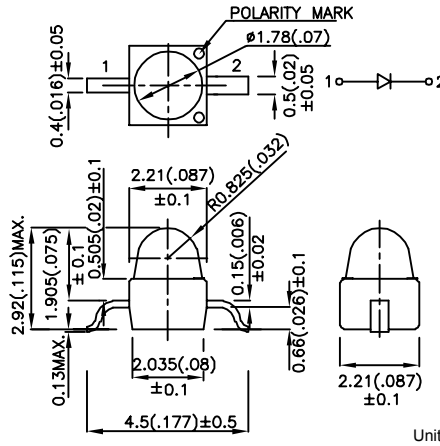

## SUBMINIATURE SMD LED

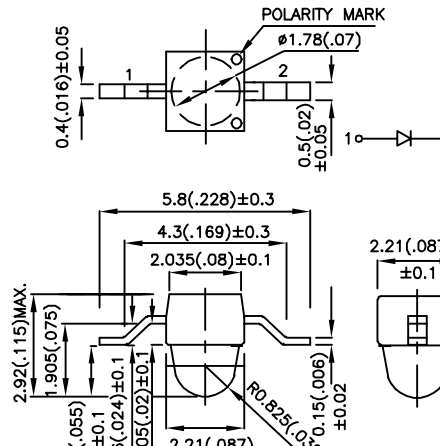
PART NUMBER	MATERIAL	$\lambda_D$ (nm)	LENS TYPE	Iv (mcd) @20mA		VIEWING ANGLE	DIMENSION	
				MIN.	TYP.			
KM-27SURCK-03	AlGaInP	630	water clear	900	2400	20°	<p>Subminiature Solid State Lamps Gull Wing Lead</p>   <p>Units : mm(inch) Tolerance : ±0.25(0.01)</p>	
KM-27SECK-03	AlGaInP	601	water clear	900	2500	20°		
KM-27SYCK-03	AlGaInP	590	water clear	900	2200	20°		
KM-27MGC-03	AlGaInP	570	water clear	380	900	20°		
KM-27CGCK-03	AlGaInP	570	water clear	280	700	20°		
KM-27ZGC-03	InGaN	525	water clear	1200	2500	20°		
KM-27ZGC-E-03	InGaN	525	water clear	2200	4000	20°		
KM-27ZGC-G-03	InGaN	525	water clear	2800	5000	20°		
KM-27QBC-D-03	InGaN	470	water clear	180	500	20°		
KM-27QBC-F-03	InGaN	465	water clear	480	850	20°		
KM-27QBC-G-03	InGaN	465	water clear	650	1300	20°		
KM-27SURCK-09	AlGaInP	630	water clear	900	2400	20°		<p>Subminiature Solid State Lamps Z-Bend Lead</p>   <p>Units : mm(inch) Tolerance : ±0.25(0.01)</p>
KM-27SECK-09	AlGaInP	601	water clear	900	2500	20°		
KM-27SYCK-09	AlGaInP	590	water clear	900	2200	20°		
KM-27MGC-09	AlGaInP	570	water clear	380	900	20°		
KM-27CGCK-09	AlGaInP	570	water clear	280	700	20°		
KM-27ZGC-09	InGaN	525	water clear	1200	2500	20°		
KM-27ZGC-E-09	InGaN	525	water clear	2200	4000	20°		
KM-27ZGC-G-09	InGaN	525	water clear	2800	5000	20°		
KM-27QBC-D-09	InGaN	470	water clear	180	500	20°		
KM-27QBC-F-09	InGaN	465	water clear	480	850	20°		
KM-27QBC-G-09	InGaN	465	water clear	650	1300	20°		

REVERSE MOUNT SMD LED

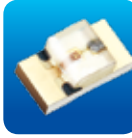
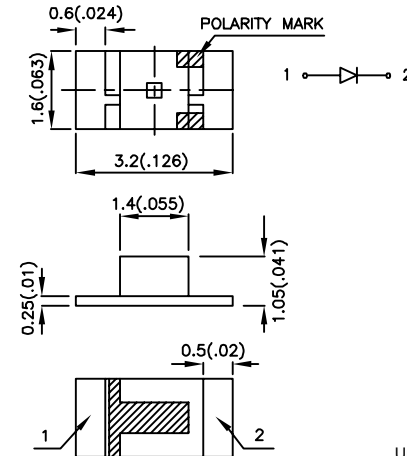
PART NUMBER	MATERIAL	$\lambda_D$ (nm)	LENS TYPE	Iv (mcd) @20mA		VIEWING ANGLE 2 $\theta$ 1/2	DIMENSION
				MIN.	TYP.		
KPTR-3216SURCK	AlGaInP	630	water clear	70	220	120°	3.2mm x 1.6mm x 1.05mm (1206 Reverse Mount)  KPTR-3216  Units : mm(inch) Tolerance : ±0.2(0.008)
KPTR-3216SECK	AlGaInP	601	water clear	70	240	120°	
KPTR-3216SYCK	AlGaInP	590	water clear	50	150	120°	
KPTR-3216MGC	AlGaInP	570	water clear	36	70	120°	
KPTR-3216CGCK	AlGaInP	570	water clear	10	50	120°	
KPTR-3216ZGC	InGaIn	525	water clear	110	300	120°	
KPTR-3216ZGC-E	InGaIn	525	water clear	280	650	120°	
KPTR-3216ZGC-G	InGaIn	525	water clear	380	700	120°	
KPTR-3216QBC-D	InGaIn	470	water clear	36	100	120°	
KPTR-3216QBC-F	InGaIn	465	water clear	50	150	120°	
KPTR-3216QBC-G	InGaIn	465	water clear	70	180	120°	

NOTE:  
1.KP series custom-made is available upon request.

SOT-23 SMD LED

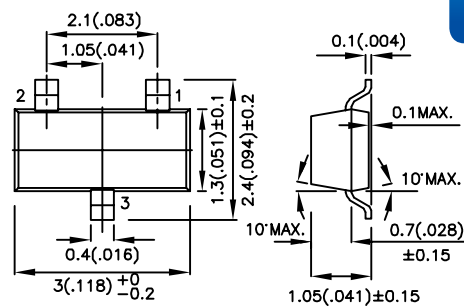
PART NUMBER	MATERIAL	$\lambda_D$ (nm)	LENS TYPE	Iv (mcd) @20mA		VIEWING ANGLE 2 $\theta$ 1/2	DIMENSION
				MIN.	TYP.		
KM-23ID-F	GaAsP/GaP	625	red diffused	4	12	140°	SOT-23 Surface Mount LED Lamp (3mm x 1.3mm)  KM-23-F  Units : mm(inch) Tolerance : ±0.25(0.01)
KM-23EC-F	GaAsP/GaP	625	water clear	4	15	140°	
KM-23SRD-F	GaAlAs	640	red diffused	36	70	140°	
KM-23SRC-F	GaAlAs	640	water clear	36	90	140°	
KM-23YD-F	GaAsP/GaP	588	yellow diffused	2.6	8.5	140°	
KM-23YC-F	GaAsP/GaP	588	water clear	2.6	10	140°	
KM-23SYD-F	AlGaInP	590	yellow diffused	50	100	140°	
KM-23SYC-F	AlGaInP	590	water clear	50	150	140°	
KM-23SGD-F	GaP	568	green diffused	2.6	8	140°	
KM-23SGC-F	GaP	568	water clear	4	15	140°	
KM-23CGCK-F	AlGaInP	570	water clear	18	50	140°	
KM-23ZGC-F	InGaIn	525	water clear	70	250	140°	
KM-23ZGC-E-F	InGaIn	525	water clear	110	450	140°	
KM-23ZGC-G-F	InGaIn	525	water clear	280	500	140°	
KM-23QBC-D-F	InGaIn	470	water clear	36	80	140°	
KM-23QBC-F-F	InGaIn	465	water clear	50	100	140°	
KM-23QBC-G-F	InGaIn	465	water clear	70	140	140°	

## AMBIENT LIGHT SENSOR

### PART NUMBER

KPS-3227SP1C

### ELECTRICAL AND RADIANT CHARACTERISTICS (Ta = 25°C, UNLESS OTHERWISE SPECIFIED)

PARAMETER	SYMBOL	MIN.	TYP.	MAX.	UNIT	TEST CONDITION
Collector Emitter Breakdown Voltage	BV <sub>ceo</sub>	60	-	-	V	I <sub>ceo</sub> =100μA
Emitter Collector Breakdown Voltage	BV <sub>eco</sub>	4	-	-	V	I <sub>eco</sub> =100μA
Collector Dark Current	I <sub>D</sub>	-	10	100	nA	V <sub>CE</sub> =5V E <sub>V</sub> =0Lx
Angle Of half Sensitivity	2θ1/2	-	120	-	°	-
Light Current(1)	I <sub>PH1</sub>	-	6	-	μA	V <sub>CE</sub> =5V, E <sub>V</sub> =100 Lx <sup>[1]</sup>
Light Current(2)	I <sub>PH2</sub>	-	130	-	μA	V <sub>CE</sub> =5V, E <sub>V</sub> =1000 Lx <sup>[1]</sup>
Light Current(3)	I <sub>PH3</sub>	-	950	-	μA	V <sub>CE</sub> =5V, E <sub>V</sub> =10000 Lx <sup>[2]</sup>
Light Current(4)	I <sub>PH4</sub>	-	420	-	μA	V <sub>CE</sub> =5V, E <sub>V</sub> =1000 Lx <sup>[3]</sup>
Saturation Output Voltage	V <sub>o</sub>	4.5	4.7	-	V	V <sub>CC</sub> =5V, E <sub>V</sub> =1000Lx <sup>[1]</sup> , R <sub>L</sub> =75KΩ
Peak Wavelength	λ <sub>P</sub>	-	580	-	nm	-
Response Wavelength	λ	390	-	700	nm	>10% Response
Collector Emitter Saturation Voltage	V <sub>CE(sat)</sub>	-	-	0.4	V	I <sub>C</sub> =10 mA

#### Notes:

- 1.White Fluorescent light (Color Temperature = 6200K) is used as light source.
- 2.Illuminance by CIE standard illuminant-A/2856K, incandescet lamp.
- 3.Sunlight (Color Temperature = 4600K) is used as light source.

### DIMENSION

KPS-3227SP1C 3.2mm x 2.7mm x 1.1mm  
(AMBIENT LIGHT SENSOR)



KPS-3227SP1C

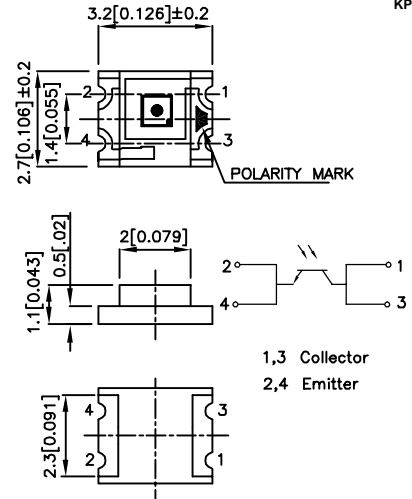

1,3 Collector  
2,4 Emitter

Units : mm(inch)  
Tolerance : ±0.1(0.004)

## COLOR SENSOR

### PART NUMBER

KPS-5130PD7C

### ELECTRICAL AND RADIANT CHARACTERISTICS (Ta = 25°C, UNLESS OTHERWISE SPECIFIED)

PARAMETER	SYMBOL	CONDITION	MIN.	TYP.	MAX.	UNIT	
Peak Sensitivity Wavelength	λ <sub>P</sub>	Red	-	620	-	nm	
		Green	-	550	-		
		Blue	-	470	-		
Light Current (1)	I <sub>L1</sub>	100Lux [1] VR = 5V	Red	-	0.039	-	μA
			Green	-	0.042	-	
			Blue	-	0.022	-	
Light Current (2)	I <sub>L2</sub>	1000Lux [1] VR = 5V	Red	-	0.427	-	V
			Green	-	0.498	-	
			Blue	-	0.262	-	
Diameter of the irradiation sensitive area	D		-	2.0	-	mm	
Irradiation sensitive area per element	A		-	0.85	-	mm <sup>2</sup>	
Photo sensibility of the single color areas	S <sub>Max</sub>	λ R=620 nm λ G=550 nm λ B=470 nm		0.33	-	A/W	
				0.25	-		
				0.18	-		
Reverse Dark Current	I <sub>D</sub>	VR = 5V	-	-	10	nA	

#### Note:

- 1.White fluorescent light (Color Temperature = 6500K) is used as light source.

### DIMENSION

KPS-5130PD7C 5.12mm x 3mm x 1.1mm  
(RGB COLOR SENSOR)



KPS-5130PD7C

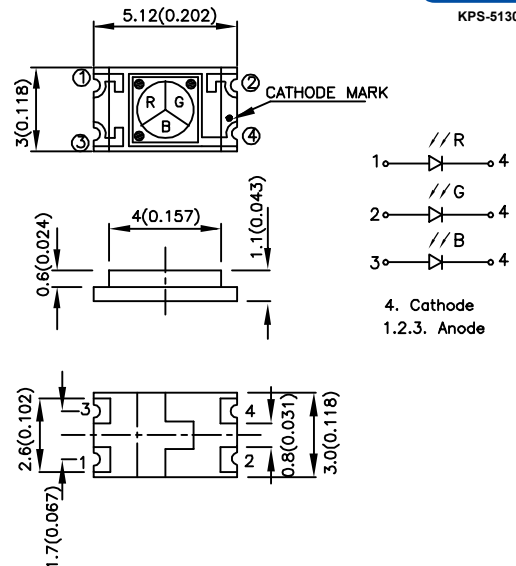

1 // R  
2 // G  
3 // B  
4. Cathode  
1,2,3. Anode

Units : mm(inch)  
Tolerance : ±0.1(0.004)

## X-ON Electronics

Largest Supplier of Electrical and Electronic Components

*Click to view similar products for [Standard LEDs - SMD category](#):*

*Click to view products by [Kingbright manufacturer](#):*

Other Similar products are found below :

[LTST-C19GD2WT](#) [LTST-N683GBEW](#) [597-3006-607F](#) [597-3403-607F](#) [LTW-K140SZR40](#) [LTW-M140ZVS](#) [598-8110-100F](#) [598-8170-100F](#)  
[598-8610-202F](#) [7012X7](#) [AAAF5060QBFSEEZGS](#) [12-22SURSYGC/S530-A3/E2/TR8](#) [1383SURT/S530-A3/TR1\(R\)](#) [APT1608QGW](#)  
[EASV1803BA0](#) [HT-F104TW-5860](#) [SML310BATT86](#) [SML-512VWT86A](#) [SML-LX0606SISUGC/A](#) [SML-LXL1307SRC-TR](#) [SML-](#)  
[LXR851SIUPGUBC](#) [LT1ED53A](#) [17-21/G6C-FM1N2B/3T](#) [FAT801-S](#) [SSL-LXA227IC-TR31A](#) [AM27ZGC03](#) [APB3025SGNC](#)  
[APHK1608VGCA](#) [APT2012QGW](#) [CLMVC-FKA-CA1E1L81BB7C3C3](#) [CLYBA-FKA-CFHHL9BBB7A363](#) [CMD11504UR](#) [LTW-](#)  
[020ZDCG](#) [LTW-21TS5](#) [LTW-K140SZR30](#) [HSMY-C177](#) [HT-121UYG-4739](#) [UYGT801-S](#) [KVH1C100MF6R](#) [42-21SYGC/S530-E1/TR8](#)  
[YGFR411-H](#) [597-2311-402F](#) [5973212407NF](#) [597-3302-607F](#) [597-5202-407F](#) [598-8330-117F](#) [SAW8WA2A-L35M40-CA](#) [SML013WBDW1](#)  
[SML522BUWT86](#) [SML-LX0402IC-TR](#)