

REV.	MODIFICATION.	DATE	DRN
01	NEW DRAWING	07/08/06	NJB
02	CO2011037	14/01/11	SF
03	CO2011253	16/04/12	SF

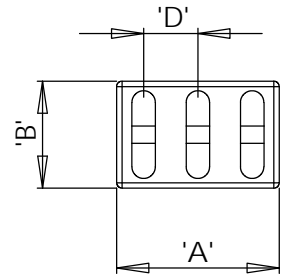

Fig 1.

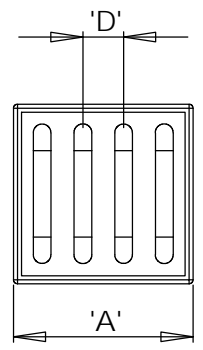
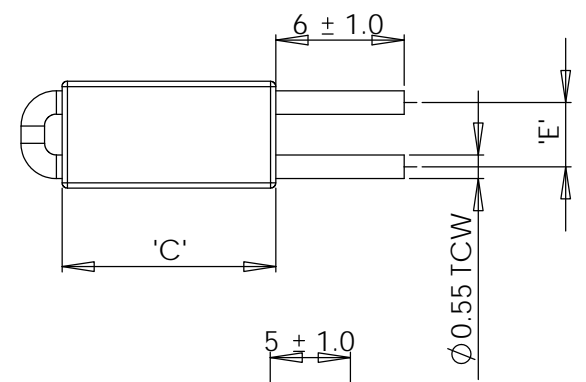

Fig 2.

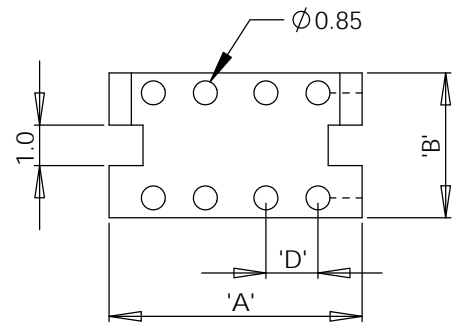
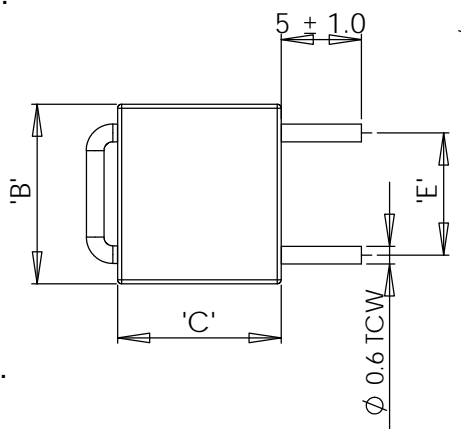

Fig 3.

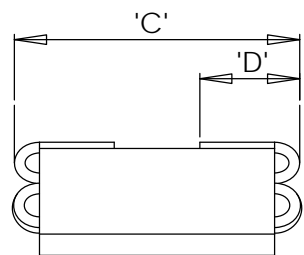
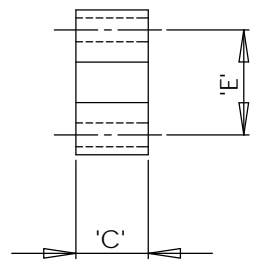
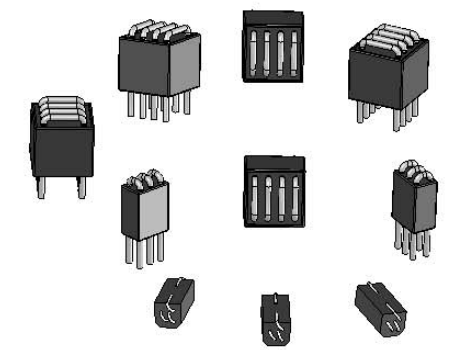
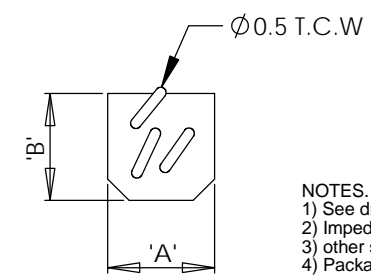

Fig 4.



- NOTES.
- 1) See drawing 06-084 sheet 2 of 2 for Impedance graphs.
 - 2) Impedance figures are typical values.
 - 3) other sizes available by special order.
 - 4) Packaging information is only a guide & subject to variation.

Ferrite Material: A5 RMS-303 - Wire: RMS-307 - Glue: RMS-301									
PART NUMBER	A	B	C	D	E	FIG	IMPEDENCE(Ω)		QTY PAD
							25mhz	100mhz	
RSH5-5055-46	5.00 ± 0.25	5.00 Max	8.00 Max	2.00 Min	-	4	289	416	1000
RSH5-5085-46			11.00 Max	3.50 Max			437	592	
RSH6-7680-50	7.60 ± 0.25	5.00 ± 0.20	8.00 ± 0.25	2.54 ± 0.10	2.54 ± 0.10	1	119	189	200
RSH6-76-10050A			10.00 ± 0.25				2.60 ± 0.15	171	
RSH8-10226-60A	10.20 ± 0.30	6.00 ± 0.20	2.60 ± 0.15	7.62 ± 0.20	2	2	48	73	1000
RSH8-112102112A	11.20 ± 0.30	11.20 ± 0.30	10.20 ± 0.25				236	383	280

INFORMATION CONTAINED IN THIS DOCUMENT IS CONFIDENTIAL TO RICHCO INTERNATIONAL Co. Ltd. AND MAY NOT BE DISCLOSED OR REPRODUCED IN WHOLE OR PART WITHOUT THEIR WRITTEN CONSENT.

RICHCO, INC.
WWW.RICHCO-INC.COM

ALL DIMENSIONS IN MM
 GENERAL TOLERANCES ±0.25
 UNLESS OTHERWISE STATED
 1 DECIMAL PLACE ±
 2 DECIMAL PLACES ±
 ANGULAR ±1°

THIRD ANGLE

MATERIAL: See Table		COLOUR: See Table	
DESCRIPTION: RSH Multiline Suppressor Beads		PART No: See Table	
DRG No: 06-084	NPR No:	Mass:(g)	SHEET SIZE A3
DRN NJB	DATE 07/08/06	CHKD AS	DATE 07/08/06
SCALE NTS	SHEET No. 1 OF 2		

REV.	MODIFICATION.	DATE	DRN
01	NEW DRAWING	07/08/06	NJB
02	CO2011037	14/01/11	SF
03	CO2011253	16/04/12	SF

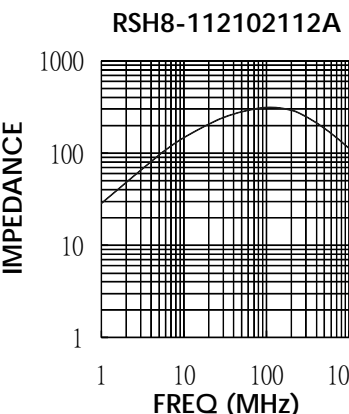
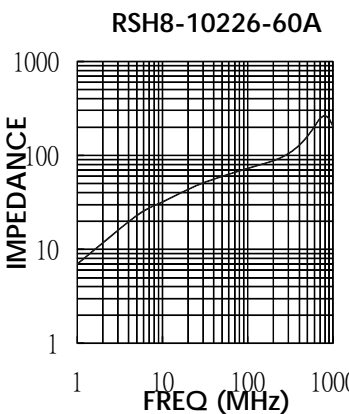
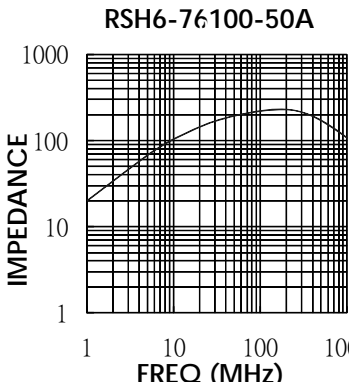
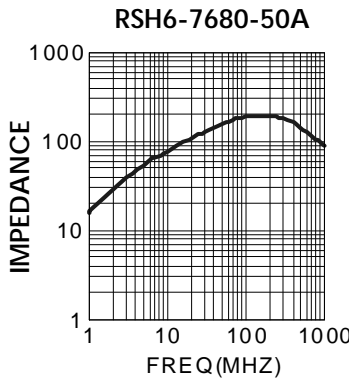
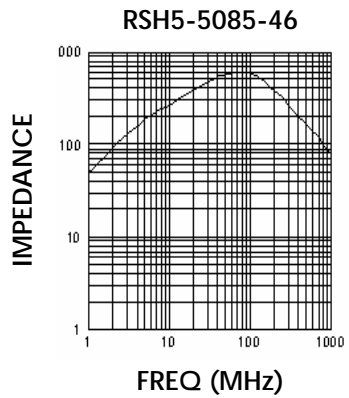
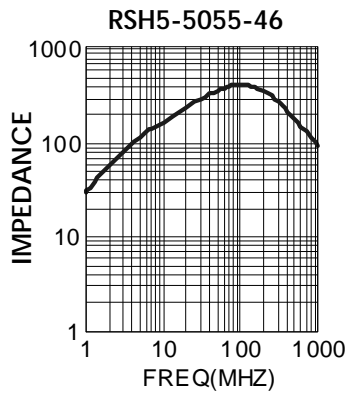

NOTES.
1) Impedance figures are typical values.

INFORMATION CONTAINED IN THIS DOCUMENT IS CONFIDENTIAL TO RICHCO INTERNATIONAL Co. Ltd. AND MAY NOT BE DISCLOSED OR REPRODUCED IN WHOLE OR PART WITHOUT THEIR WRITTEN CONSENT.

RICHCO, INC.
WWW.RICHCO-INC.COM

DESCRIPTION:
RSH Multiline Suppressor Beads, Impedance Graphs.

DRG No: 06-084		SHEET SIZE A3	
DRN NJB	DATE 07/08/06	CHKD AS	SCALE NTS
DATE 07/08/06		SHEET No. 2 OF 2	

X-ON Electronics

Largest Supplier of Electrical and Electronic Components

Click to view similar products for [Ferrite Beads](#) category:

Click to view products by [Richco](#) manufacturer:

Other Similar products are found below :

[2943778301](#) [BMB1J0120BN3JIT](#) [82350120560](#) [0261014605](#) [2643066902](#) [3061000011](#) [2673045901](#) [2643083601](#) [2643074901](#) [4361142521](#)
[4078078621](#) [4078044821](#) [4078033621](#) [CZB2BFTTE121P](#) [BMB2A0120AN2](#) [BMB1J0200BN3JIT](#) [EMI0805R-220](#) [74279250](#) [7427924](#)
[CZB1JGTTD202P](#) [MAF0603GWY551AT000](#) [MAF1005GWZ102AT000](#) [BLM18HE152SH1D](#) [2944778302](#) [BLM02PX600SN1D](#) [SMB2.5-1](#)
[EMI1206R-600](#) [BLM02KX180SN1D](#) [BLM02BC100SN1D](#) [BLM02KX100SN1D](#) [BLM02BB101SN1D](#) [BLM02BC220SN1D](#)
[BLE32PN260SH1L](#) [BLE32PN260SN1L](#) [BLE32PN260SZ1L](#) [74275013](#) [7427503](#) [BLM18HE601SH1D](#) [BLM15BD152SN1D](#)
[BLM15BD152SZ1D](#) [BLE18PS080SZ1D](#) [BLM21PG221BH1D](#) [WLBD1005HCU330TL](#) [BLM21AG471BH1D](#) [BLE18PS080BH1D](#)
[BLM21AG331BH1D](#) [BLM21PG300BH1D](#) [BLM21PG600BH1D](#) [BLM03HB401SZ1D](#) [BLM03HB401SN1D](#)