

TEMPERATURE CONTROLLER

33 x 72

KR1 model

Quick Guide • ISTR - FKRIENG03



DECLARATION OF CONFORMITY AND MANUAL RETRIEVAL

KR1 is a panel mounting, Class II instrument. It has been designed with compliance to the European Directives. All information about the controller use can be found in the Engineering Manual: ISTR-MKR-ENG0x ("x" is the revision). The Declaration of Conformity and the manual of the controller can be downloaded (free of charge) from the web-site:

www.ascontecnologic.com

Once connected to the web-site, search:

KR1
then click on **KR1**.

In the lower part of the product page (in any language) is present the download area with links to the documents available for the controller (in the available languages).

Warning!

- Whenever a failure or a malfunction of the device may cause dangerous situations for persons, things or animals, please remember that the plant must be equipped with additional devices which will guarantee safety.

- We warrant that the products will be free from defects in material and workmanship for 18 months from the date of delivery. Products and components that are subject to wear due to conditions of use, service life and misuse are not covered by this warranty.

DISPLAY AND KEYS

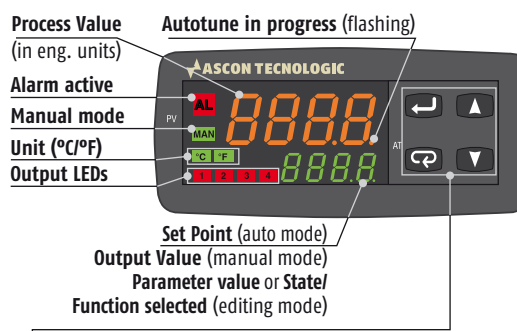

	Operator Mode	Editing Mode
	Access to: - Operator Commands (Timer, Setpoint selection ...) - Parameters - Configuration	Confirm and go to Next parameter
	Access to: - Operator additional information (Output value, running time ...)	Increase the displayed value or select the next element
	Access to: - Set Point	Decrease the displayed value or select the previous element
	Start the programmed function (Autotune, Auto/Man, Timer ...)	Exit from Operator commands/Parameter setting/Configuration

DIMENSIONS

Overall dimensions (L x H x D): 78 x 35 x 69.5 mm
(3.07 x 1.37 x 2.73 in.)
Panel Cut-out (L x H): 71+0.6 x 29+0.6 mm
(2.79+0.023 x 1.14+0.023 in.)

MOUNTING

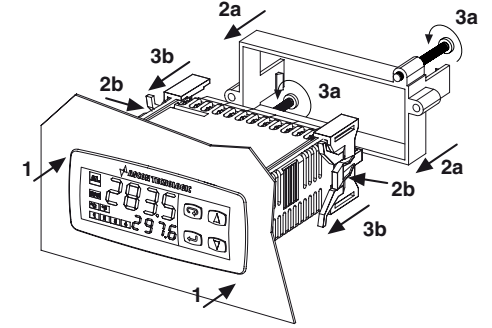

Attention

The controller can be installed using 2 different types of brackets. Follow the sequence 1, 2a, 3a for the closed version of the bracket, the sequence 1, 2b, 3b for the 2 pieces bracket type.



viale Indipendenza 56, 27029 - Vigevano (PV) - ITALIA
Tel.: +39 0381 698 71, Fax: +39 0381 698 730
Site internet: www.ascontecnologic.com
E-mail: sales@ascontecnologic.com

MODEL CODE

The Hardware resources are identified by the following Model Code.

Model: KR 1 A B C D E F G H I - 0 0 0 0

Line	KR	1
Optional functions		A
None	-	-
Timer	-	T
Power Supply		B
100... 240Vac (-15... +10%)	H	H
24Vac (-25... +12%) or 24Vdc (-15... +25%)	L	L
Input		C
TC, Pt100, PT1000, mA, mV, V + Digital Input 1	C	C
TC, NTC, PTC, mA, mV, V + Digital Input 1	E	E
Output OP1		D
Relay (1 SPDT, 4 A/250 Vac)	R	R
VDC for SSR (12 Vdc/20 mA)	O	O
Output OP2		E
None	-	-
Relay (1 SPST NO, 4 A/250 Vac)	R	R
VDC for SSR VDC for SSR (12 Vdc/20 mA)	O	O

Output OP3	F
None	-
Relay (1 SPST NO, 4 A/250 Vac)	R
Vdc for SSR VDC for SSR (12 Vdc/20 mA)	O
Output OP4	G
Digital I/O (see the Electrical Connections paragraph for details)	D
Serial Communications	H
TTL	-
RS485 Modbus	S
Terminal Type	I
Standard (screw type non removable terminal blocks)	-
With plug-in screw type terminal blocks	E
With plug-in clamp type terminal blocks	M
With plug-in terminal blocks (fixed part only)	N

Model Code example: KR1-HCRRRD--

Controller KR1, no timer, 100... 240 Vac, TC/Pt100/PT1000/mV/V + Digital Input 1, 3 Relay Outputs, Output 4, TTL, non removable screw type terminals.

ELECTRICAL CONNECTIONS

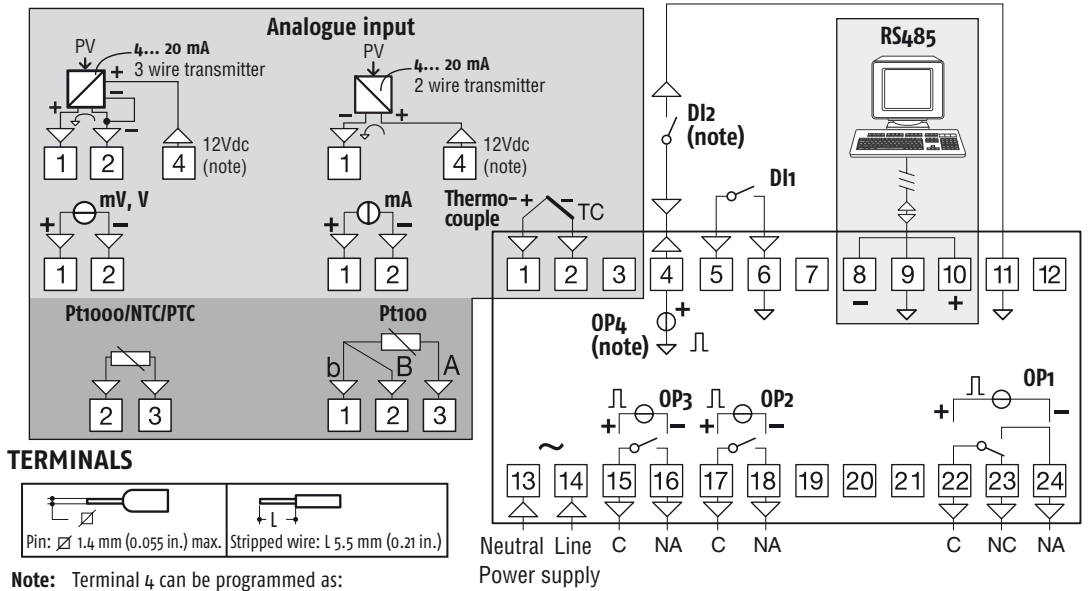

TERMINALS

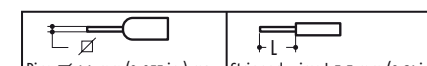

Note: Terminal 4 can be programmed as:

- Digital Input (DI2) connecting a free of voltage contact between terminals 4 and 11;
- 0... 12 V SSR Drive Output (OP4) connecting the load between terminals 4 and 11;
- 12 Vdc (20 mA) transmitter power supply connecting the 2 wire transmitter between terminals 4 and 1; for 3 wire transmitter connect terminal 4 to transmitter power supply input and terminal 1 and 2 to transmitter signal output.

Supply voltage: 100... 240 Vac/
18... 28 Vac/
20... 30 Vdc

CONFIGURATION CODE

The KR1 can be easily configured by the "Code Configuration" method for the most common requirements, just entering two 4-digit codes: $Code1$ [LMNO] for the Input Type and Control Mode selection and $Code2$ [PQRS] for the Alarms and the Service Functions. For complete controller configuration see the Engineering Manual.

Note: Before starting the configuration code setting, please define and write down $Code1$ and $Code2$ as needed:

HOW TO SET THE CONFIGURATION CODE



Press for 3 seconds to access the configuration mode



Press and to enter the configuration Password 4 (default 300)



Press and to enter $Code1$ (Input Type and Control Mode)



Press and to enter $Code2$ (Alarms and Service Functions)



Press to store the Configuration code

Note: To leave the Configuration session without saving the settings made, press the key



Input Type and Range	L	M
TC J	-50... +1000°C	0 0
TC K	-50... +1370°C	0 1
TC S	-50... 1760°C	0 2
TC R	-50... +1760°C	0 3
TC T	-70... +400°C	0 4
Infrared J	-50... +785°C	0 5
Infrared K	-50... +785°C	0 6
PT 100/PTC KTY81-121	-200... +850°C/-55... +150°C	0 7
PT 1000/NTC 103-AT2	-200... +850°C/-50... +110°C	0 8
Linear 0... 60 mV		0 9
Linear 12... 60 mV	1	0
Linear 0... 20 mA (this selection forces Out 4 = TX)	1	1
Linear 4... 20 mA (this selection forces Out 4 = TX)	1	2
Linear 0... 5 V	1	3
Linear 1... 5 V	1	4
Linear 0... 10 V	1	5
Linear 2... 10 V	1	6
TC J	-58... +1832°F	1 7
TC K	-58... +2498°F	1 8
TC S	-58... 3200°F	1 9
TC R	-58... +3200°F	2 0
TC T	-94... +752°F	2 1
Infrared J	-58... +1445°F	2 2
Infrared K	-58... +1445°F	2 3
PT 100/PTC KTY81-121	-328... +1562°F/-67... +302°F	2 4
PT 1000/NTC 103-AT2	-328... +1562°F/-58... +230°F	2 5



Alarm	P	Q	R
Alarm 3			
Alarm 2			
Alarm 1			
Not used	0	0	0
Sensor break	1	1	1
Absolute High	2	2	2
Absolute Low	3	3	3
Absolute High/Low	4	4	4
Deviation High	5	5	5
Deviation Low	6	6	6
Band High	7	7	7
Band Low	8	8	8
Band External	9	9	9

Control mode	OP1	OP2	OP3	OP4	N	O
ON/OFF heating = H	H	AL1	AL2	AL3	0	0
ON/OFF cooling = C	C	AL1	AL2	AL3	0	1
ON/OFF with neutral zone (H/C)	H	C	AL2	AL3	0	4
PID heating = H	H	AL1	AL2	AL3	1	1
PID cooling = C	C	AL1	AL2	AL3	1	2
PID double action (H/C)	H	C	AL2	AL3	1	4
	H	AL1	AL2	C	1	5
	C	H	AL2	AL3	1	6
	H	H	AL2	C	1	7
	C	AL1	AL2	H	1	8
	NU	C	AL2	H	1	9

Note: As default, when the alarms are active, only AL1 threshold is available at "Operator Command" level to perform non critical tasks. To protect the AL2 and AL3 thresholds against undesired changes, they are available only at "Parameters list" level (password: 20). For different configurations, see the Engineering Manual.

Service functions activation	S
None	0
Wattmeter (instantaneous power expressed in kW) (note 1)	1
Wattmeter (Power consumption expressed in kWh/h) (note 2)	2
Absolute worked time (expressed in days) (note 3)	3
Absolute worked time (expressed in hours) (note 3)	4

Note: 1. **Wattmeter Instantaneous power** is continuously computed as multiplication of the Load Voltage, Load Current parameter values and the controller output instantaneous value.
2. **Wattmeter power consumption** is the estimated hourly energy consumption (using Load Voltage and Load Current parameter values), computed on the previous 15 minutes period. The readout is updated every 15 minutes.
3. **Worked Time counter** is continuously increased when the controller is turned ON.

ALARM TYPES ($Code2$ digits: P, Q, R)

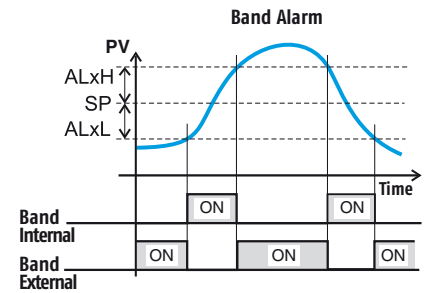
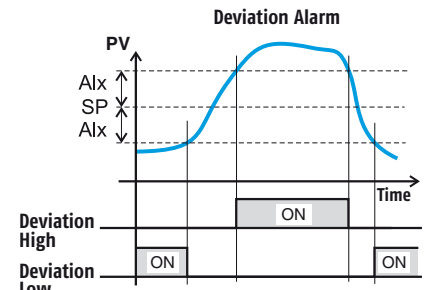
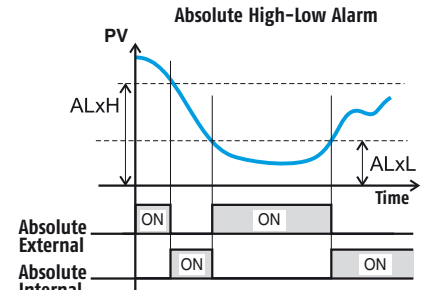
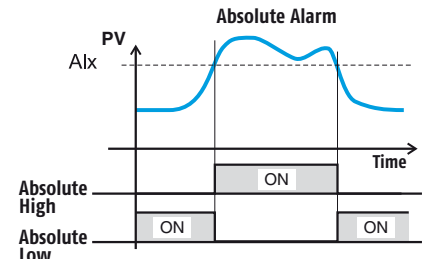

PARAMETERS SETTING

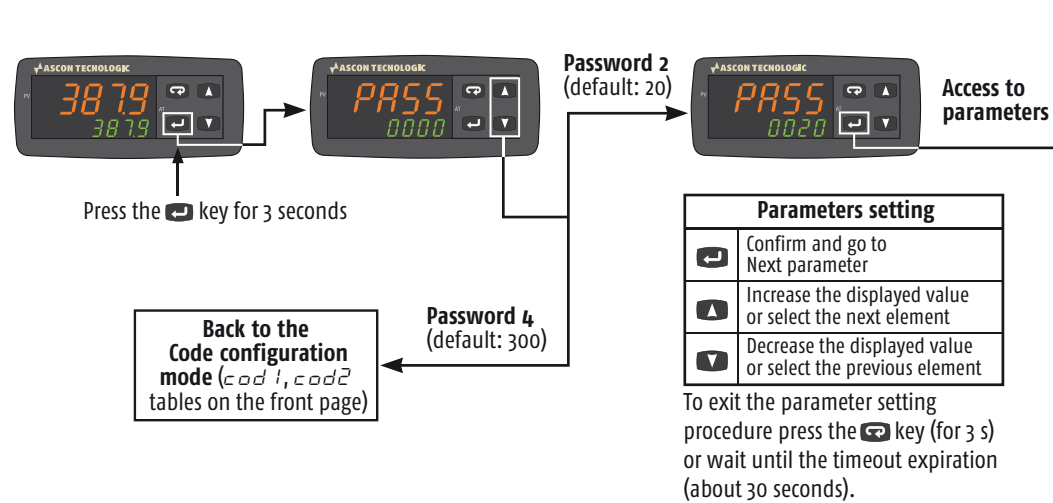

CONTROLLER OPERATION

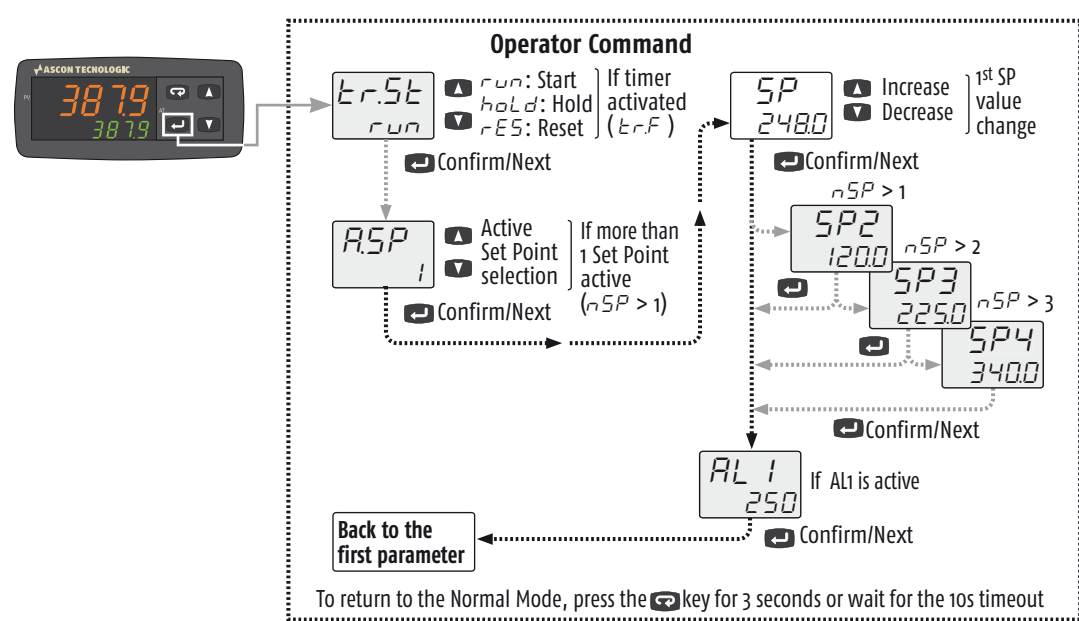
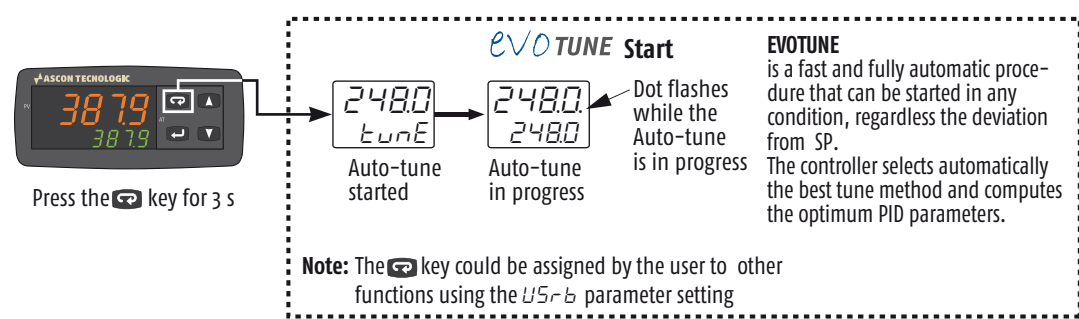
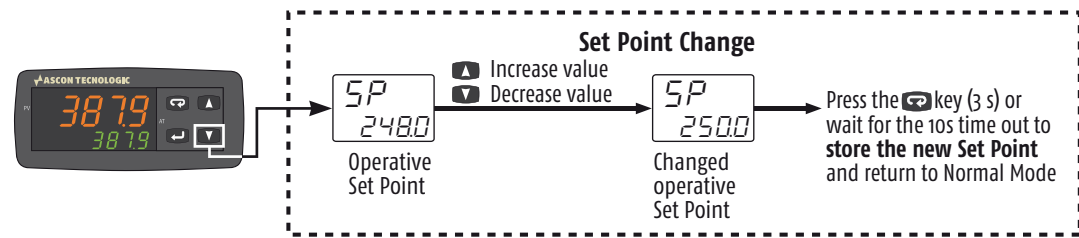
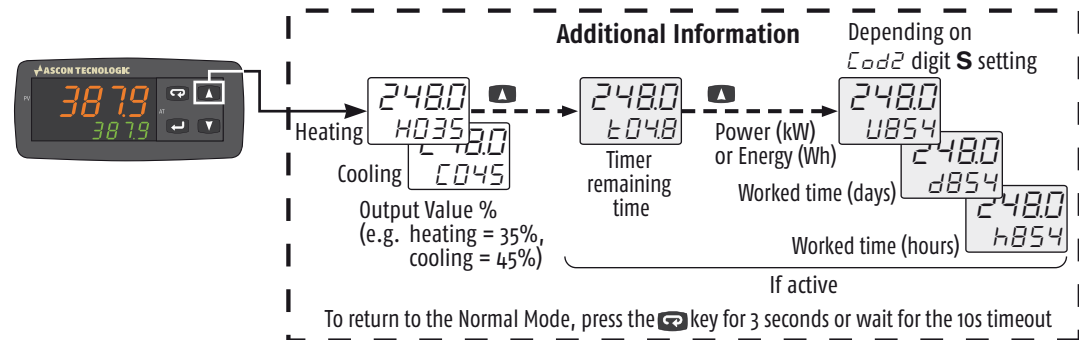

Parameters List (PASS: 20) (in gray the parameters related to optional features)

Group	Param.	Description	Range value or selection list elements	Default	User value	Note
Commands	<i>trSt</i>	Timer status				Option
	<i>oPEr</i>	Operative Mode Selection	reg = Auto, oplo = Manual, stdy = Standby			
	<i>RSP</i>	Set Point Selection	0 = SP, 1 = SP2, 2 = SP3, 3 = SP4	0 = SP		
Control	<i>tunE</i>	Start Auto Tune	0 = OFF, 1 = start	0 = OFF		evoTUNE
	<i>Pb</i>	Proportional Band	1... 9999 (Engineering Units = E.U.)	20		
	<i>tI</i>	Integral Time	0... 10000 s	200		Code 1 Digit N = 1
	<i>tD</i>	Derivative Time	0... 1000 s	50		
	<i>HSEt</i>	Hysteresis ON/OFF Control	0... 9999 (E.U.)	1		Code 1 Digit N = 0
	<i>tCH</i>	Heating output cycle time	0.1... 130 s	20.0		Code 1 Digit N = 1
	<i>rCG</i>	Relative Cooling Gain	0.01... 99.99	1.00		Code 1 Digit N = 1 Code 1 Digit O > 4
Set Point	<i>tCC</i>	Cooling output cycle time	0.1... 130 s	20.0		Code 1 Digit N = 1 Code 1 Digit O > 1
	<i>SP</i>	Set Point 1	-1999... +9999 (E.U.)			
	<i>SP2</i>	Set Point 2				If nSP > 1
	<i>SP3</i>	Set Point 3	-1999... +9999 (E.U.)			If nSP > 2
	<i>SP4</i>	Set Point 4				If nSP > 3
	<i>SPLL</i>	Set Point min. Value	-1999... SPHL (E.U.)			
	<i>SPHL</i>	Set Point max. Value	SPLL... 9999 (E.U.)			
Alarms	<i>nSP</i>	No. of Set Points	1... 4	1		
	<i>AL1</i>	Alarm 1 threshold	AL1L... AL1H			
	<i>AL1L</i>	Alarm 1 low threshold/Low limit	-1999... +9999 (E.U.)	-1999		If digit P of Code 2 is > 1
	<i>AL1H</i>	Alarm 1 high threshold/High limit		9999		
	<i>HAL1</i>	AL1 hysteresis	1... 9999 (E.U.)	1		
	<i>AL2</i>	Alarm 2 threshold	AL2L... AL2H			
	<i>AL2L</i>	Alarm 2 low threshold/Low limit	-1999... +9999 (E.U.)	-1999		If digit Q of Code 2 is > 1
	<i>AL2H</i>	Alarm 2 high threshold/High limit		9999		
	<i>HAL2</i>	AL2 hysteresis	1... 9999 (E.U.)	1		
Soft Start	<i>AL3</i>	Alarm 3 threshold	AL3L... AL3H			
	<i>AL3L</i>	Alarm 3 low threshold/Low limit	-1999... +9999 (E.U.)	-1999		If digit R of Code 2 is > 1
	<i>AL3H</i>	Alarm 3 high threshold/High limit		9999		
Input	<i>HAL3</i>	AL3 hysteresis	1... 9999 (E.U.)	1		
	<i>SSeP</i>	Soft Start Output value	-100... 100%	0		
	<i>SSeT</i>	Soft Start Time	0.00... 8.00 (hh.mm)	0		
Timer	<i>SSc</i>	Low Scale readout	-1999... 9999	-1999		For linear Input types only
	<i>FSc</i>	High Scale readout	-1999... 9999	9999		
	<i>dP</i>	Number of decimals	0... 3 (linear inputs); 0... 1 (other inputs)	0		
I/O	<i>FIL</i>	Measured value Digital filter	OFF; 0.1... 20.0 s	0 = OFF		
	<i>trF</i>	Timer Type	nonE = Timer not used i.d.A = Delayed ON at start command i.u.P.d = Activation ON at Power ON i.d.d = At start command i.P.L = Asymmetrical oscillator, start in OFF i.L.P = Asymmetrical oscillator, start in ON	none		Timer management (Start, Stop, Reset) can be done using the <i>trSt</i> command or the key (if programmed) or by the Dh/Dl2 digital inputs (if programmed).
	<i>trU</i>	Timer Units	0 = hh.mm 1 = mm.ss 2 = sss.d	1 = mm.ss		
	<i>trt1</i>	Time 1	00.00... 995.9	1.00		
Digital Inputs	<i>trt2</i>	Time 2	00.00... 995.9	1.00		
	<i>io4F</i>	I/O 4 Function	ON = Transmitter Power Supply OUT4 = SSR out Di2C = Dig. In. from contact Di2U = 24 VDC Digital Input	ON		
	<i>dIF1</i>	Digital Input 1 Function	0... 21	0		See the Dh, Dl2 functions table
Display	<i>dIF2</i>	Digital Input 2 Function	0... 21	0		
	<i>USrb</i>	Key Function	nonE, tunE, oplo, aac, asi, chsp, st.by, str.t	tunE		See the Key function table
	<i>dICL</i>	Colour of the Process Value display	0 = Change 1 = Red 2 = Green 3 = Orange	2		If Change, the colour is green if PV differs from SP less than AdE, red if higher than AdE and orange if is lower than AdE
Serial communications	<i>AdE</i>	Display change color threshold (when dICL = 0)	0 (OFF)... 9999 (e.u.)			
	<i>dStE</i>	Display Power OFF time (mm.ss)	OFF (display ON) 0.1... 99.59	OFF		
Wattmeter	<i>AdD</i>	Instrument Address	1... 254	1		Modbus RTU slave protocol
	<i>Baud</i>	Baud rate	1200, 2400, 9600 baud, 19.2, 38.4 kbaud	9600		
Password	<i>UoLE</i>	Load Voltage	1... 999 (V)	230		If digit S of Code 2 is > 1
	<i>cuR</i>	Load Current	1... 9999 (A)			
	<i>PRs4</i>	Configuration access Password	0... 999	300		
	<i>PRs2</i>	Parameters access Password	0... 999	20		

Note: To access all the instrument features, please see the "Complete configuration procedure" in the "Engineering Manual".

Complete Configuration and Parameter setting can be easily uploaded from the controller and downloaded to other controllers using the Configuration Key and Communication Adapter model: A-01.

FUNCTION SELECTION

Timer Types (selected by trF) (option)

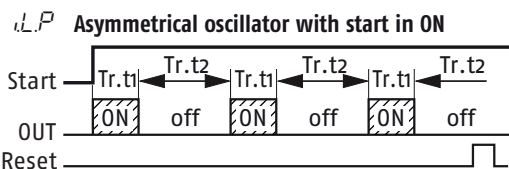
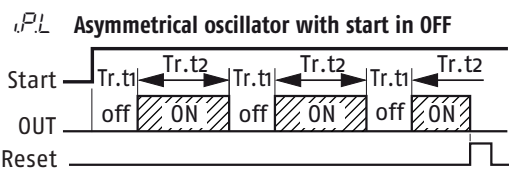
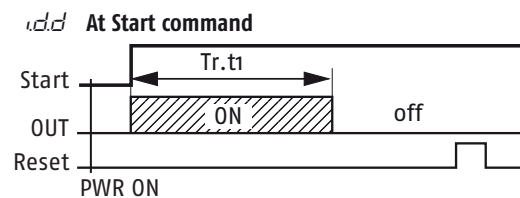
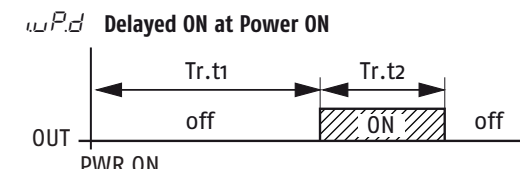
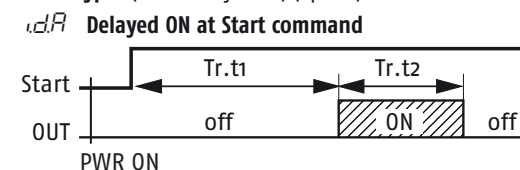

dIF - Digital Inputs Dh and Dl2 Functions

Code displayed	Description
0	Disabled (OFF) (default)
1	Alarm Reset
2	Alarm Acknowledge (ACK)
3	Hold of the measured value
4	Stand by mode
5	Manual Mode
6	Heat with "SP" and Cool with "SP2"
7	Timer Run/Hold/Reset [on transition]
8	Timer Run [on transition]
9	Timer Reset [on transition]
10	Timer Run/Hold
11	Timer Run/Reset
12	Timer Run/Reset with lock at the end of the time count
18	Sequential Set Point selection [on transition]
19	SP/SP2 selection
20	Binary coding for Set Point selection on Dh and Dl2 (00 = SP, 01 = SP2, 10 = SP3, 11 = SP4)
21	Digital inputs in parallel to key and key (Dh = key, Dl2 = key)

USrb Key Function

Code displayed	Description
nonE	Not used
tunE	Starts auto tuning functions (default)
oPLo	Manual mode
ARc	Alarm Reset
AS	Alarm Acknowledge
chSP	Circular Set Point Selection (shows SP, SP2, SP3)
Stby	Stand-by mode
StEt	Starts/Stop/Reset timer

X-ON Electronics

Largest Supplier of Electrical and Electronic Components

Click to view similar products for [Temperature Sensor Modules](#) category:

Click to view products by [Ascon](#) manufacturer:

Other Similar products are found below :

[HPP809A031](#) [MBT 3560-0000-0050-10-110](#) [MBT 3560-0000-0100-10-110](#) [MBT 3560-0001-0050-10-120](#) [MBT 3560-0001-0100-10-120](#)
[TCN4L-22R](#) [TX4H-14R](#) [TX4H-24R](#) [TX4H-A4R](#) [TX4H-B4R](#) [TX4L-14R](#) [TX4L-A4R](#) [TX4L-B4R](#) [TX4M-14R](#) [TX4M-24R](#) [TX4M-A4R](#)
[TX4M-B4R](#) [QP99](#) [CP-02](#) [CP82](#) [CP99](#) [R38-LAOO](#) [R38-LARR](#) [72-11304023-0150.0050](#) [72-11304027-0150.0050](#) [72-23304003-](#)
[0150.0050.GGP](#) [72-23904001-0300.0040.TM](#) [72-34904001-0300.0040.TM](#) [TEM 73 A](#) [AT403-414-1000](#) [AT403-614-1000](#) [AT-503-1141-000](#)
[AT-503-1161-000](#) [AT-503-6140-000](#) [AT-603-1141-000](#) [AT603-414-1000](#) [AT-903-1161-000](#) [ATR121-AD](#) [ATR121-B](#) [TPMC-5](#) [TPMC-8W](#)
[K39-HCRR](#) [K39T-HCRR](#) [K49-HCRR](#) [K49P-HCRR](#) [K85-HERR](#) [KR1-LCRR-D](#) [LHI874](#) [LHI944](#) [LHI968](#)