

## RTS-01 Series

### Characteristic

RTS-01 high power resistors are made in a thick film technology, on a 2mm stainless steel substrate. Resistors are characterized by a high power at small size, and high resistance to a temporary overloads. RTS-01 resistors have very low inductance, what makes them useful at high frequency circuits. Construction of element allows for a quick installation on heatsink (SOT-227 housing compatibility). RTS-01 series elements have outputs in the form of contact/solder fields, soldered wires, connectors, or screw terminals.

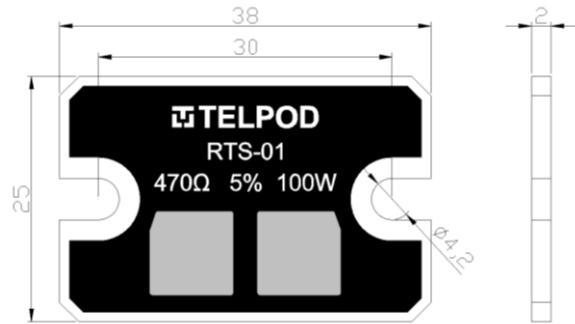
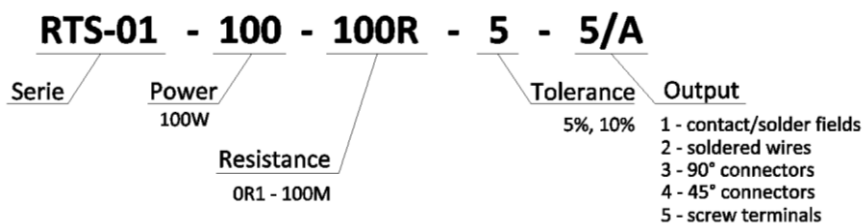

Fig. 1. Preview with dimensions [mm]

Parameter	Value
Nominal resistance	E24 series
Range of available resistances	0,1 Ω ... 1 MΩ
Resistance tolerance	±5%, ±10 %
Rated power (on heatsink)	100W
Dielectric layer breakdown voltage	> 2,5 kV
Temperature coefficient of resistance (TCR)	±100 ppm/°C
Max. element temperature (on surface)	400 °C
Max. element temperature (with soldered connectors or wires)	170 °C

### Product marking



## RTS-01 Series

### Terminal types

#### RTS-01- ... -1

Contact / solder fields

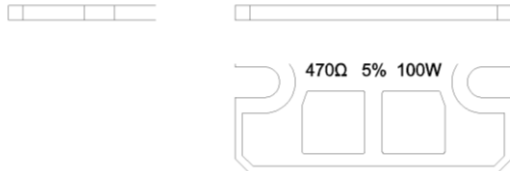

#### RTS-01- ... -2

Soldered wires

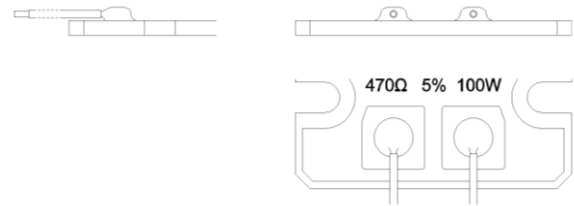

#### RTS-01- ... -3/4.8

4.8 connectors at 90°

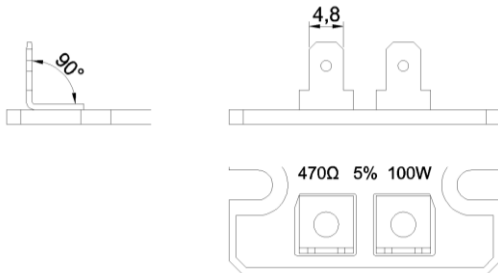

#### RTS-01- ... -3/6.3

6.3 connectors at 90°

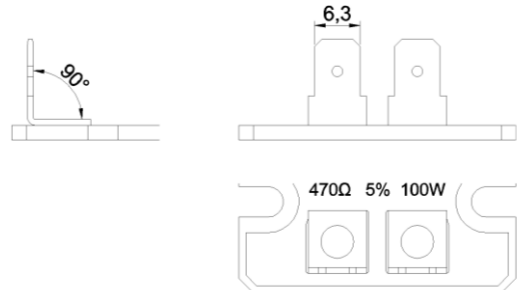

#### RTS-01- ... -4/4.8

4.8 connectors at 45°

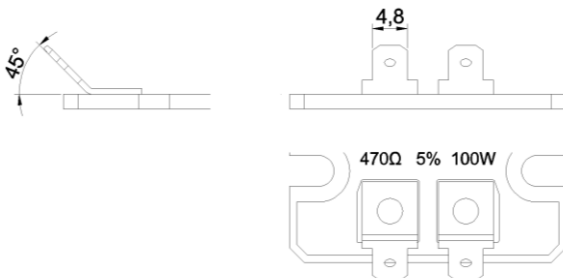

#### RTS-01- ... -4/6.3

6.3 connectors at 45°

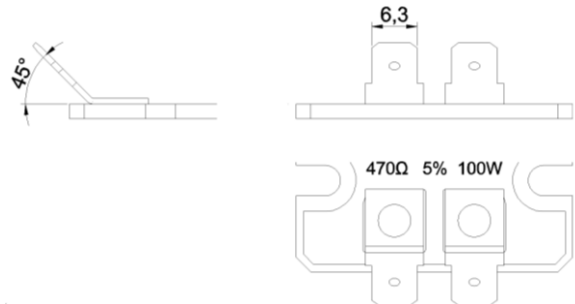

#### RTS-01- ... -5/A

Screw connectors with the nuts

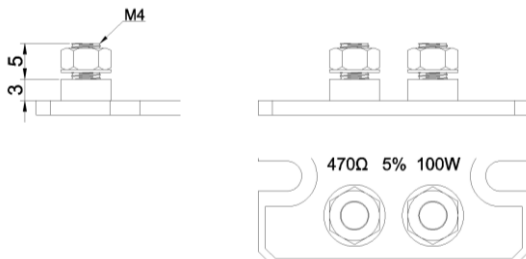

#### RTS-01- ... -5/B

Screw connectors with the screws

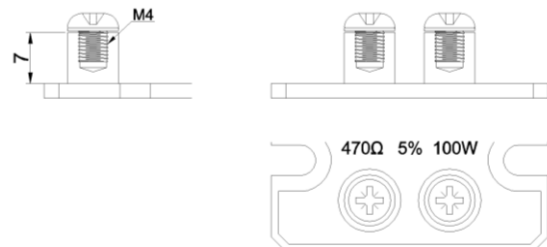

### TELPOD S.A.

str. Pilsudskiego 63A  
32-050 Skawina  
[www.telpod.pl](http://www.telpod.pl)

Technical division: +48 (0)12 257 10 12  
Sales division: +48 (0)12 257 10 35  
fax: +48 (0)12 257 10 13  
e-mail: [thickfilm@telpod.pl](mailto:thickfilm@telpod.pl)

date: 05 / 2015  
Copyright 2015 by Telpod

## X-ON Electronics

Largest Supplier of Electrical and Electronic Components

*Click to view similar products for [Wirewound Resistors - SMD category:](#)*

*Click to view products by [Telpod manufacturer:](#)*

Other Similar products are found below :

[SMW5120RJT](#) [SMW518RJT](#) [SMW524RJT](#) [SMW52R2JT](#) [SMW530RJT](#) [WSM24R99FLFTR](#) [RWS5 R47 J B](#) [RWS5 R68 F B](#) [SMW516RJT](#)  
[SMW52R7JT](#) [SMW57R5JT](#) [SMW5R33JT](#) [SMW5R39JT](#) [SMW551RJT](#) [SMW5R11JT](#) [RWS5 82R F B](#) [RWS5 1R F B](#) [RWS5 120R F B](#)  
[RWS5 10R F B](#) [RWS5 100R J B](#) [SMW51R2JT](#) [SMW512RJT](#) [ACS-10S-15R-J](#) [PRZDAWJW101B00](#) [SMW3300RJT](#) [RW7S0FB180RJET](#)  
[RW5S0FA470RJET](#) [RW7S0FB4K70JET](#) [RW7S0FB4K70FET](#) [RWS5 1R J B](#) [RWS5 33R J B](#) [QL0000J0100200](#) [QL0000J0220200](#)  
[QL0000J0470100](#) [QL0000J047J100](#) [QL0050J0362000](#) [QL0050J0470000](#) [R100W-10R](#) [R100W-22R](#) [R150W-470R](#) [HEWRB0J0220600](#)  
[R200W-22R](#) [R50W-10R](#) [R50W-22R](#) [R50W-2R2](#) [R80W-47R](#) [SMW5R51JT](#) [SMW5R36JT](#) [SMW5R24JT](#) [SMW591RJT](#)